

P5QL

Motherboard

ASUS®

E4412

Second Edition V2

January 2009

Copyright © 2009 ASUSTeK Computer Inc. All Rights Reserved.

No part of this manual, including the products and software described in it, may be reproduced, transmitted, transcribed, stored in a retrieval system, or translated into any language in any form or by any means, except documentation kept by the purchaser for backup purposes, without the express written permission of ASUSTeK Computer Inc. ("ASUS").

Product warranty or service will not be extended if: (1) the product is repaired, modified or altered, unless such repair, modification or alteration is authorized in writing by ASUS; or (2) the serial number of the product is defaced or missing.

ASUS PROVIDES THIS MANUAL "AS IS" WITHOUT WARRANTY OF ANY KIND, EITHER EXPRESS OR IMPLIED, INCLUDING BUT NOT LIMITED TO THE IMPLIED WARRANTIES OR CONDITIONS OF MERCHANTABILITY OR FITNESS FOR A PARTICULAR PURPOSE. IN NO EVENT SHALL ASUS, ITS DIRECTORS, OFFICERS, EMPLOYEES OR AGENTS BE LIABLE FOR ANY INDIRECT, SPECIAL, INCIDENTAL, OR CONSEQUENTIAL DAMAGES (INCLUDING DAMAGES FOR LOSS OF PROFITS, LOSS OF BUSINESS, LOSS OF USE OR DATA, INTERRUPTION OF BUSINESS AND THE LIKE), EVEN IF ASUS HAS BEEN ADVISED OF THE POSSIBILITY OF SUCH DAMAGES ARISING FROM ANY DEFECT OR ERROR IN THIS MANUAL OR PRODUCT.

SPECIFICATIONS AND INFORMATION CONTAINED IN THIS MANUAL ARE FURNISHED FOR INFORMATIONAL USE ONLY, AND ARE SUBJECT TO CHANGE AT ANY TIME WITHOUT NOTICE, AND SHOULD NOT BE CONSTRUED AS A COMMITMENT BY ASUS. ASUS ASSUMES NO RESPONSIBILITY OR LIABILITY FOR ANY ERRORS OR INACCURACIES THAT MAY APPEAR IN THIS MANUAL, INCLUDING THE PRODUCTS AND SOFTWARE DESCRIBED IN IT.

Products and corporate names appearing in this manual may or may not be registered trademarks or copyrights of their respective companies, and are used only for identification or explanation and to the owners' benefit, without intent to infringe.

Contents

Notices.....	vi
Safety information	vii
About this guide	vii
P5QL specifications summary	ix

Chapter 1: Product introduction

1.1	Welcome!	1-1
1.2	Package contents	1-1
1.3	Special features	1-1
1.3.1	Product highlights	1-1
1.3.2	Innovative ASUS features	1-2
1.4	Before you proceed	1-4
1.5	Motherboard overview	1-5
1.5.1	Placement direction	1-5
1.5.2	Screw holes	1-5
1.5.3	Motherboard layout	1-6
1.5.4	Layout contents.....	1-6
1.6	Central Processing Unit (CPU)	1-7
1.6.1	Installing the CPU	1-7
1.6.2	Installing the CPU heatsink and fan	1-10
1.6.3	Uninstalling the CPU heatsink and fan	1-11
1.7	System memory	1-11
1.7.1	Overview	1-11
1.7.2	Memory configurations.....	1-12
1.7.3	Installing a DIMM	1-16
1.7.4	Removing a DIMM	1-16
1.8	Expansion slots	1-17
1.8.1	Installing an expansion card	1-17
1.8.2	Configuring an expansion card	1-17
1.8.3	PCI slots.....	1-17
1.8.4	PCI Express x1 slots.....	1-17
1.8.5	PCI Express x16 slot.....	1-17
1.9	Jumpers	1-18
1.10	Connectors	1-20
1.10.1	Rear panel connectors.....	1-20
1.10.2	Internal connectors	1-21

Contents

- 1.11 Software support..... 1-28**
 - 1.11.1 Installing an operating system 1-28
 - 1.11.2 Support DVD information 1-28

- Chapter 2: BIOS information**
- 2.1 Managing and updating your BIOS 2-1**
 - 2.1.1 Creating a bootable floppy disk..... 2-1
 - 2.1.2 ASUS Update utility 2-2
 - 2.1.3 ASUS EZ Flash 2 utility..... 2-3
 - 2.1.4 AFUDOS utility 2-4
 - 2.1.5 ASUS CrashFree BIOS 3 utility 2-5
- 2.2 BIOS setup program 2-6**
 - 2.2.1 BIOS menu screen..... 2-7
 - 2.2.2 Menu bar..... 2-7
 - 2.2.3 Navigation keys..... 2-8
 - 2.2.4 Menu items 2-8
 - 2.2.5 Submenu items 2-8
 - 2.2.6 Configuration fields 2-8
 - 2.2.7 Pop-up window 2-8
 - 2.2.8 Scroll bar..... 2-8
 - 2.2.9 General help 2-9
- 2.3 Main menu 2-9**
 - 2.3.1 System Time 2-9
 - 2.3.2 System Date 2-9
 - 2.3.3 Legacy Diskette A 2-9
 - 2.3.4 SATA 1-6..... 2-10
 - 2.3.5 Storage Configuration..... 2-10
 - 2.3.6 System Information 2-11
- 2.4 Ai Tweaker menu 2-11**
- 2.5 Advanced menu 2-16**
 - 2.5.1 CPU Configuration 2-16
 - 2.5.2 Chipset..... 2-17
 - 2.5.3 Onboard Devices Configuration..... 2-17
 - 2.5.4 USB Configuration 2-18
 - 2.5.5 PCI PnP 2-18

Contents

2.6	Power menu	2-19
2.6.1	Suspend Mode.....	2-19
2.6.2	ACPI 2.0 Support.....	2-19
2.6.3	ACPI APIC Support.....	2-19
2.6.4	APM Configuration.....	2-19
2.6.5	Hardware Monitor	2-20
2.7	Boot menu	2-21
2.7.1	Boot Device Priority	2-21
2.7.2	Boot Settings Configuration	2-21
2.7.3	Security	2-22
2.8	Tools menu	2-24
2.8.1	ASUS EZ Flash 2.....	2-24
2.8.2	Express Gate	2-24
2.8.3	AI NET 2.....	2-25
2.9	Exit menu	2-25

Notices

Federal Communications Commission Statement

This device complies with Part 15 of the FCC Rules. Operation is subject to the following two conditions:

- This device may not cause harmful interference, and
- This device must accept any interference received including interference that may cause undesired operation.

This equipment has been tested and found to comply with the limits for a Class B digital device, pursuant to Part 15 of the FCC Rules. These limits are designed to provide reasonable protection against harmful interference in a residential installation. This equipment generates, uses and can radiate radio frequency energy and, if not installed and used in accordance with manufacturer's instructions, may cause harmful interference to radio communications. However, there is no guarantee that interference will not occur in a particular installation. If this equipment does cause harmful interference to radio or television reception, which can be determined by turning the equipment off and on, the user is encouraged to try to correct the interference by one or more of the following measures:

- Reorient or relocate the receiving antenna.
- Increase the separation between the equipment and receiver.
- Connect the equipment to an outlet on a circuit different from that to which the receiver is connected.
- Consult the dealer or an experienced radio/TV technician for help.



The use of shielded cables for connection of the monitor to the graphics card is required to assure compliance with FCC regulations. Changes or modifications to this unit not expressly approved by the party responsible for compliance could void the user's authority to operate this equipment.

Canadian Department of Communications Statement

This digital apparatus does not exceed the Class B limits for radio noise emissions from digital apparatus set out in the Radio Interference Regulations of the Canadian Department of Communications.

This class B digital apparatus complies with Canadian ICES-003.



DO NOT throw the motherboard in municipal waste. This product has been designed to enable proper reuse of parts and recycling. This symbol of the crossed out wheeled bin indicates that the product (electrical and electronic equipment) should not be placed in municipal waste. Check local regulations for disposal of electronic products.



DO NOT throw the mercury-containing button cell battery in municipal waste. This symbol of the crossed out wheeled bin indicates that the battery should not be placed in municipal waste.

Safety information

Electrical safety

- To prevent electric shock hazard, disconnect the power cable from the electric outlet before relocating the system.
- When adding or removing devices to or from the system, ensure that the power cables for the devices are unplugged before the signal cables are connected. If possible, disconnect all power cables from the existing system before you add a device.
- Before connecting or removing signal cables from the motherboard, ensure that all power cables are unplugged.
- Seek professional assistance before using an adapter or extension cord. These devices could interrupt the grounding circuit.
- Make sure that your power supply is set to the correct voltage in your area. If you are not sure about the voltage of the electrical outlet you are using, contact your local power company.
- If the power supply is broken, do not try to fix it by yourself. Contact a qualified service technician or your retailer.

Operation safety

- Before installing the motherboard and adding devices on it, carefully read all the manuals that came with the package.
- Before using the product, make sure all cables are correctly connected and the power cables are not damaged. If you detect any damage, contact your dealer immediately.
- To avoid short circuits, keep paper clips, screws, and staples away from connectors, slots, sockets and circuitry.
- Avoid dust, humidity, and temperature extremes. Do not place the product in any area where it may become wet.
- Place the product on a stable surface.
- If you encounter technical problems with the product, contact a qualified service technician or your retailer.

About this guide

This user guide contains the information you need when installing and configuring the motherboard.

How this guide is organized

This guide contains the following parts:

- **Chapter 1: Product introduction**
This chapter describes the features of the motherboard and the new technology it supports.
- **Chapter 2: BIOS information**
This chapter tells how to change system settings through the BIOS Setup menus. Detailed descriptions of the BIOS parameters are also provided.

Where to find more information

Refer to the following sources for additional information and for product and software updates.

1. ASUS websites

The ASUS website provides updated information on ASUS hardware and software products. Refer to the ASUS contact information.

2. Optional documentation

Your product package may include optional documentation, such as warranty flyers, that may have been added by your dealer. These documents are not part of the standard package.

Conventions used in this guide

To make sure that you perform certain tasks properly, take note of the following symbols used throughout this manual.



DANGER/WARNING: Information to prevent injury to yourself when trying to complete a task.



CAUTION: Information to prevent damage to the components when trying to complete a task.



IMPORTANT: Instructions that you **MUST** follow to complete a task.



NOTE: Tips and additional information to help you complete a task.

Typography

Bold text

Indicates a menu or an item to select.

Italics

Used to emphasize a word or a phrase.

<Key>

Keys enclosed in the less-than and greater-than sign means that you must press the enclosed key.

Example: <Enter> means that you must press the Enter or Return key.

<Key1>+<Key2>+<Key3>

If you must press two or more keys simultaneously, the key names are linked with a plus sign (+).

Example: <Ctrl>+<Alt>+<D>

Command

Means that you must type the command exactly as shown, then supply the required item or value enclosed in brackets.

Example: At the DOS prompt, type the command line:

```
afudos /i [filename]
```

```
afudos /iP5QL.ROM
```

P5QL specifications summary

CPU	LGA775 Socket for Intel® Core™2 Extreme / Core™2 Quad / Core™2 Duo / Pentium® Dual-Core / Celeron® Dual-Core / Celeron® processors Compatible with Intel® 05B/05A/06 processors Supports Intel® 45nm multi-core CPU
Chipset	Intel® P43 / ICH10 with Intel® Fast Memory Access Technology
System bus	1600(O.C.)/1333/1066/800/533MHz
Memory	Dual-channel memory architecture <ul style="list-style-type: none"> - 4 x 240-pin DIMM sockets support unbuffered non-ECC DDR2 1066/800/667MHz memory modules - Supports up to 16GB system memory <p>* Refer to www.asus.com or this user manual for the Memory QVL (Qualified Vendors Lists)</p> <p>** When you install a total memory of 4GB or more, Windows® 32-bit operating system may only recognize less than 3GB. Hence, a total installed memory of less than 3GB is recommended if you are using a Windows 32-bit operating system.</p>
Expansion slots	1 x PCIe x16 slot 2 x PCIe x1 slots 3 x PCI slots
Storage	Intel ICH10 southbridge supports: <ul style="list-style-type: none"> - 6 x Serial ATA 3.0Gb/s ports Marvell® 88SE6102 PATA controller supports: <ul style="list-style-type: none"> - 1 x UltraDMA 133/100/66 for up to 2 PATA devices
LAN	Realtek® 8111C-VCO, PCIe Gigabit LAN controller featuring AI NET2
Audio	VIA VT1708S, 8-channel High-Definition Audio CODEC <ul style="list-style-type: none"> - Supports Jack-detect and Multi-streaming - Coaxial S/PDIF Out port at back I/O - ASUS Noise Filter
USB	12 x USB 2.0 ports (6 at mid-board, 6 at back panel)
BIOS features	8Mb Flash ROM, AMI BIOS, PnP, DMI 2.0, WfM 2.0, SM BIOS 2.5, ACPI 2.0a, ASUS EZ Flash 2, ASUS CrashFree BIOS 3
ASUS unique features	ASUS Power Saving Solution: <ul style="list-style-type: none"> - ASUS AI Nap ASUS AI Life Features: <ul style="list-style-type: none"> - ASUS Express Gate ASUS Crystal Sound: <ul style="list-style-type: none"> - ASUS Noise Filter ASUS EZ DIY: <ul style="list-style-type: none"> - ASUS CrashFree BIOS 3 - ASUS EZ Flash 2

(continued on the next page)

P5QL specifications summary

ASUS exclusive overclocking features	<p>Intelligent overclocking tools:</p> <ul style="list-style-type: none"> - ASUS AI Booster <p>Precision Tweaker:</p> <ul style="list-style-type: none"> - vCore: Adjustable CPU voltage at 0.00625V increment - vDIMM: 5-step DRAM voltage control <p>SFS (Stepless Frequency Selection):</p> <ul style="list-style-type: none"> - FSB tuning from 133MHz to 600MHz at 1MHz increment - Memory tuning from 667MHz to 1333MHz for DDR2 - PCI Express frequency tuning from 100MHz to 160MHz at 1MHz increment <p>Overclocking protection:</p> <ul style="list-style-type: none"> - ASUS C.P.R. (CPU Parameter Recall)
Other features	ASUS MyLogo 2
Rear panel ports	<p>1 x PS/2 keyboard port 1 x PS/2 mouse port 1 x Coaxial S/PDIF Out port 1 x LAN (RJ-45) port 6 x USB 2.0/1.1 ports 8-channel audio I/O ports</p>
Internal connectors	<p>3 x USB connectors support 6 additional USB ports 1 x Floppy disk drive connector 1 x IDE connector 6 x Serial ATA connectors 1 x CPU / 1 x Chassis / 1 x Power fan connectors 1 x COM connector 1 x S/PDIF Out connector 1 x Chassis intrusion connector 1 x Front panel audio connector 1 x CD audio in connector 1 x 24-pin ATX power connector 1 x 4-pin ATX 12V power connector 1 x System panel connector</p>
Manageability	WfM 2.0, DMI 2.0, WOL by PME, WOR by PME, PXE
Accessories	<p>1 x UltraDMA 133/100/66 cable 1 x Serial ATA cable 1 x Serial ATA power cable 1 x I/O shield User Manual</p>
Support DVD	<p>Drivers Express Gate AI Suite ASUS PC Probe II ASUS Update Anti-Virus software (OEM version)</p>
Form factor	ATX form factor: 12 in x 7.6 in (30.5 cm x 19.3 cm)

**Specifications are subject to change without notice.*

Chapter 1

Product introduction

1.1 Welcome!

Thank you for buying an ASUS® P5QL motherboard!

The motherboard delivers a host of new features and latest technologies, making it another standout in the long line of ASUS quality motherboards!

Before you start installing the motherboard, and hardware devices on it, check the items in your package with the list below.

1.2 Package contents

Check your motherboard package for the following items.

Motherboard	ASUS P5QL motherboard
Cables	1 x Serial ATA cable 1 x Serial ATA power cable 1 x Ultra DMA 133/100/66 cable
Accessories	1 x I/O shield
Application DVD	ASUS motherboard support DVD
Documentation	User Manual



If any of the above items is damaged or missing, contact your retailer.

1.3 Special features

1.3.1 Product highlights



Intel® Core™2 Extreme / Core™2 Quad / Core™2 Duo CPU support

This motherboard supports the latest Intel® Core™2 processors in the LGA775 package and Intel® next-generation 45nm multi-core processors. With the new Intel® Core™ microarchitecture technology and 1333/1066/800MHz FSB, the Intel® Core™2 processors are among the most powerful CPUs in the world.



Intel® P43 Chipset

The Intel® P43 Express Chipset is designed to support dual-channel DDR2 1066/800/667MHz architecture, 1333/1066/800MHz Front Side Bus (FSB), PCIe 2.0, and multi-core CPUs. It supports the Intel® Fast Memory Access technology that significantly optimizes the use of available memory bandwidth and reduces the latency of the memory accesses.



PCIe 2.0 support

This motherboard supports the latest PCIe 2.0 devices for double speed and bandwidth which enhances system performance.



FSB 1600 support (O.C.)

ASUS's exclusive overclocking design now unleashes the ultimate potential of the Intel® Core™2 processors. With the new Intel 45nm microarchitecture technology and FSB 1600(O.C.)/1333/1066/800MHz, this motherboard allows you to enjoy the latest technology supported by one of the most powerful CPUs in the world.



Serial ATA 3Gb/s technology

This motherboard supports hard drives based on the Serial ATA (SATA) 3Gb/s storage specifications, delivering enhanced scalability and doubling the bus bandwidth for high-speed data retrieval and save.

1.3.2

Innovative ASUS features



ASUS MyLogo2™

This feature allows you to convert your favorite photo into a 256-color boot logo for a more colorful and vivid image on your screen.



ASUS CrashFree BIOS 3

ASUS CrashFree BIOS 3 is an auto-recovery tool that allows you to restore a corrupted BIOS file using a floppy disk, a USB flash disk, or the motherboard support DVD that contains the BIOS file.



ASUS EZ Flash 2

ASUS EZ Flash 2 is a utility that allows you to update the BIOS without using an OS-based utility.



Express Gate

Express Gate is a unique OS built into the motherboard. Five minutes after bootup, you can instantly surf the Internet without entering the Windows® OS.



-
- The actual boot time depends on the system configuration.
 - ASUS Express Gate supports file uploading from SATA HDDs, ODDs, and USB drives, and downloading to USB drives only.
-



AI Nap

With AI Nap, users can instantly snooze your PC without terminating the tasks. The system will continue operating at minimum power and noise when user is temporarily away. It keeps downloading files or running applications in quietest state while you are sleeping. Simply click keyboard or mouse, you can swiftly wake up the system in a few seconds.



Noise Filter

This feature detects repetitive and stationary noises (non-voice signals) like computer fans, air conditioners, and other background noises then eliminates it in the incoming audio stream while recording.

AI Booster

The ASUS AI Booster allows you to overclock the CPU speed in Windows® environment without the hassle of booting the BIOS.



Precision Tweaker

This feature allows you to fine-tune the CPU/memory voltage and gradually increase the memory, FSB and PCIE frequency at 1MHz increment to achieve maximum system performance.



C.P.R. (CPU Parameter Recall)

The BIOS C.P.R. feature automatically restores the CPU default settings when the system hangs due to overclocking failure. C.P.R. eliminates the need to open the system chassis and clear the RTC data. Simply shut down and reboot the system, and the BIOS automatically restores the CPU parameters to their default settings.



Green ASUS

This motherboard and its packaging comply with the European Union's Restriction on the use of Hazardous Substances (RoHS). This is in line with the ASUS vision of creating environment-friendly and recyclable products/packaging to safeguard consumers' health while minimizing the impact on the environment.

1.4 Before you proceed

Take note of the following precautions before you install motherboard components or change any motherboard settings.



- Unplug the power cord from the wall socket before touching any component.
- Before handling components, use a grounded wrist strap or touch a safely grounded object or a metal object, such as the power supply case, to avoid damaging them due to static electricity.
- Hold components by the edges to avoid touching the ICs on them.
- Whenever you uninstall any component, place it on a grounded antistatic pad or in the bag that came with the component.
- Before you install or remove any component, ensure that the ATX power supply is switched off or the power cord is detached from the power supply. Failure to do so may cause severe damage to the motherboard, peripherals, or components.

Onboard LED

The motherboard comes with a standby power LED that lights up to indicate that the system is ON, in sleep mode, or in soft-off mode. This is a reminder that you must shut down the system and unplug the power cable before removing or plugging in any motherboard component. The illustration below shows the location of the onboard LED.

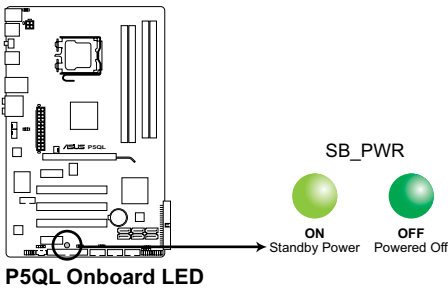

1.5 Motherboard overview

Before you install the motherboard, study the configuration of your chassis to ensure that the motherboard fits into it.



Ensure that you unplug the power cord before installing or removing the motherboard. Failure to do so can cause you physical injury and damage motherboard components.

1.5.1 Placement direction

When installing the motherboard, ensure that you place it into the chassis in the correct orientation. The edge with external ports goes to the rear part of the chassis as indicated in the image below.

1.5.2 Screw holes

Place six screws into the holes indicated by circles to secure the motherboard to the chassis.



Do not overtighten the screws! Doing so can damage the motherboard.

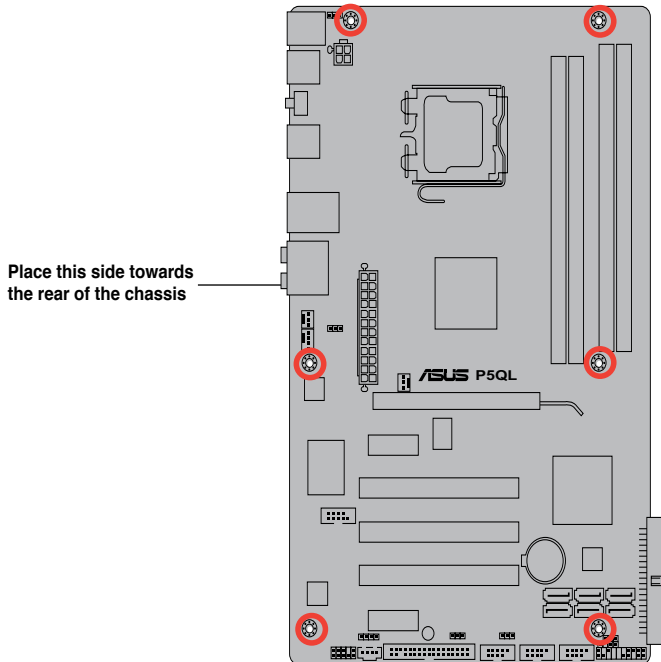

1.5.3 Motherboard layout

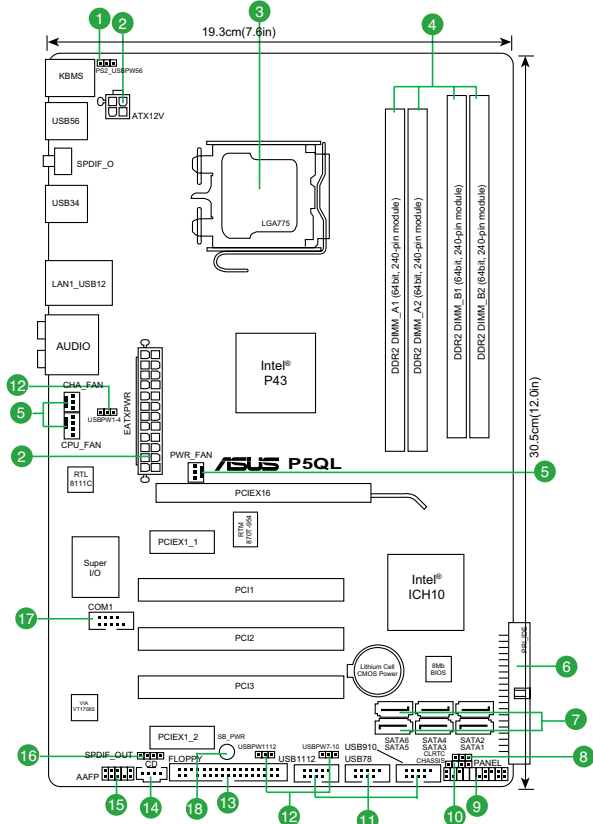

1.5.4 Layout contents

Connectors/Jumpers/Slots/LED	Page	Connectors/Jumpers/Slots/LED	Page
1. Keyboard/mouse power (3-pin PS2_USBPW56)	1-19	10. Chassis intrusion connector	1-24
2. ATX power connectors (24-pin EATXPWR, 4-pin ATX 12V)	1-26	11. USB connectors (10-1 pin USB78, USB910, USB1112)	1-26
3. LGA775 CPU socket	1-7	12. USB device wake-up (3-pin USBPW1-4, USBPW7-10, USBPW1112)	1-19
4. DDR2 DIMM slots	1-11	13. Floppy disk drive connector (34-1 pin FLOPPY)	1-21
5. CPU, chassis, and power fan connectors (4-pin CPU_FAN, 3-pin CHA_FAN, 3-pin PWR_FAN)	1-24	14. Optical drive audio connector (4-pin CD)	1-23
6. IDE connector (40-1 pin PRI_IDE)	1-23	15. Front panel audio connector (10-1 pin AAFP)	1-25
7. Serial ATA connectors (7-pin SATA1-6)	1-22	16. Digital audio connector (4-1 pin SPDIF_OUT)	1-22
8. Clear RTC RAM (3-pin CLRRTC)	1-18	17. Serial port connector (10-1 pin COM1)	1-25
9. System panel connector (20-8 pin PANEL)	1-27	18. Onboard LED (SB_PWR)	1-4

1.6 Central Processing Unit (CPU)

This motherboard comes with a surface mount LGA775 socket designed for the Intel® Core™2 Extreme / Core™2 Quad / Core™2 Duo / Pentium® Dual-Core / Celeron® Dual-Core / Celeron® processors.



- Unplug all power cables before installing the CPU.
- Connect the chassis fan cable to the CHA_FAN connector to ensure system stability.



- Upon purchase of the motherboard, ensure that the PnP cap is on the socket and the socket contacts are not bent. Contact your retailer immediately if the PnP cap is missing, or if you see any damage to the PnP cap/socket contacts/motherboard components. ASUS will shoulder the cost of repair only if the damage is shipment/transit-related.
- Keep the cap after installing the motherboard. ASUS will process Return Merchandise Authorization (RMA) requests only if the motherboard comes with the cap on the LGA775 socket.
- The product warranty does not cover damage to the socket contacts resulting from incorrect CPU installation/removal, or misplacement/loss/incorrect removal of the PnP cap.



The motherboard supports Intel® LGA775 processors with the Intel® Enhanced Intel SpeedStep® Technology (EIST) and Hyper-Threading Technology.

1.6.1 Installing the CPU

To install a CPU:

1. Locate the CPU socket on the motherboard.

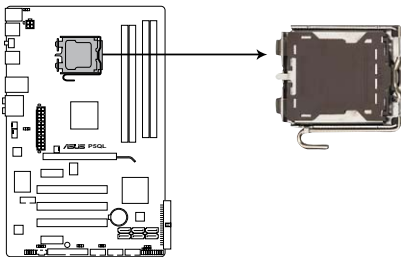

P5QL CPU Socket 775



Before installing the CPU, ensure that the cam box is facing towards you and the load lever is on your left.

2. Press the load lever with your thumb (A), then move it to the left (B) until it is released from the retention tab.



To prevent damage to the socket pins, do not remove the PnP cap unless you are installing a CPU.

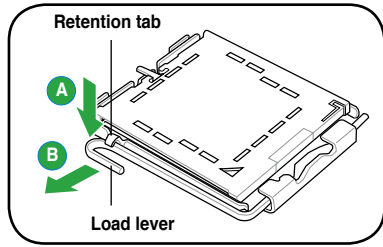

3. Lift the load lever in the direction of the arrow to a 135° angle.
4. Lift the load plate with your thumb and forefinger to a 100° angle (4A), then push the PnP cap from the load plate window to remove (4B).

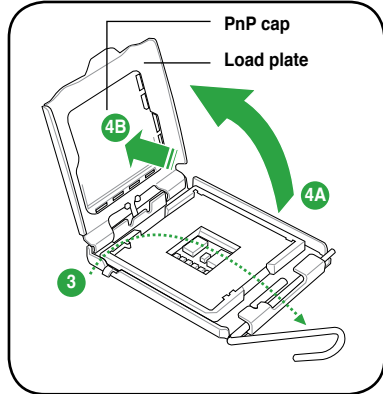

5. Position the CPU over the socket, ensuring that the gold triangle is on the bottom-left corner of the socket then fit the socket alignment key into the CPU notch.

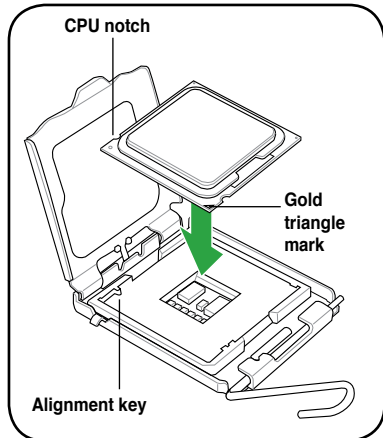

6. Apply some Thermal Interface Material to the exposed area of the CPU that the heatsink will be in contact with, ensuring that it is spread in an even thin layer.



Some heatsinks come with pre-applied thermal paste. If so, skip this step.

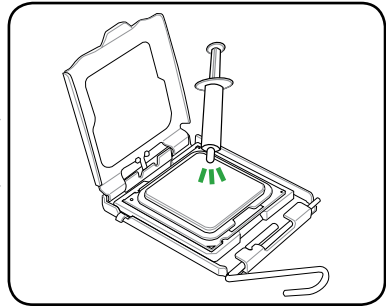

DO NOT eat the Thermal Interface Material. If it gets into your eyes or touches your skin, ensure that you wash it off immediately, and seek professional medical help.



To prevent contaminating the paste, **DO NOT** spread the paste with your finger directly.

7. Close the load plate (A), then push the load lever (B) until it snaps into the retention tab.

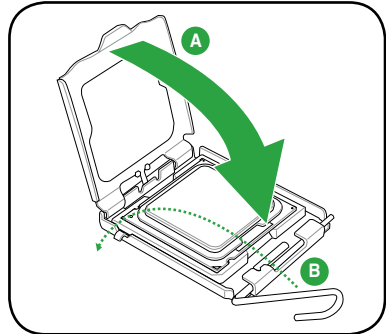

1.6.2 Installing the CPU heatsink and fan

The Intel® LGA775 processor requires a specially designed heatsink and fan assembly to ensure optimum thermal condition and performance.



- When you buy a boxed Intel® processor, the package includes the CPU fan and heatsink assembly. If you buy a CPU separately, ensure that you use only Intel®-certified multi-directional heatsink and fan.
- Ensure that you have installed the motherboard to the chassis before you install the CPU fan and heatsink assembly.
- If you purchased a separate CPU heatsink and fan assembly, ensure that you have properly applied Thermal Interface Material to the CPU heatsink or CPU before you install the heatsink and fan assembly.



Your Intel® LGA775 heatsink and fan assembly comes in a push-pin design and requires no tool to install.

To install the CPU heatsink and fan:

1. Place the heatsink on top of the installed CPU, ensuring that the four fasteners match the holes on the motherboard.



Orient the heatsink and fan assembly such that the CPU fan cable is closest to the CPU fan connector.

2. Push down two fasteners at a time in a diagonal sequence to secure the heatsink and fan assembly in place.

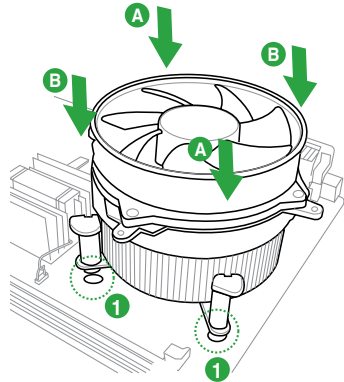
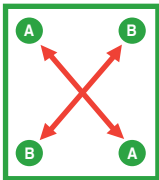

The type of CPU heatsink and fan assembly may differ, but the installation steps and functions should remain the same. The illustration above is for reference only.

3. Connect the CPU fan cable to the connector on the motherboard labeled CPU_FAN.

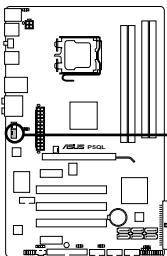

P5QL CPU fan connector

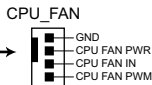

Do not forget to connect the CPU fan connector! Hardware monitoring errors can occur if you fail to plug this connector.

1.6.3 Uninstalling the CPU heatsink and fan

To uninstall the CPU heatsink and fan:

1. Disconnect the CPU fan cable from the connector on the motherboard.
2. Rotate each fastener counterclockwise.
3. Pull up two fasteners at a time in a diagonal sequence to disengage the heatsink and fan assembly from the motherboard.

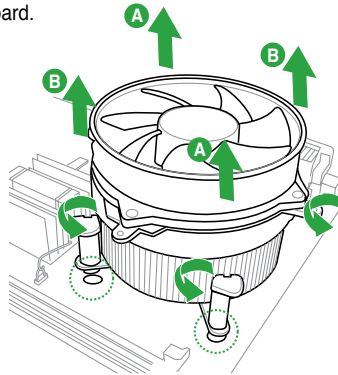
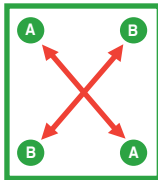

4. Carefully remove the heatsink and fan assembly from the motherboard.
5. Rotate each fastener clockwise to ensure correct orientation when reinstalling.

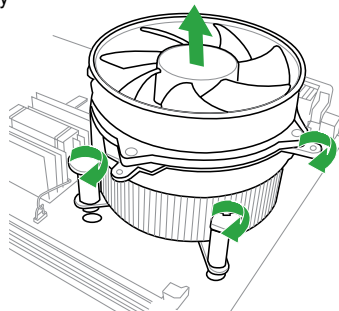

1.7 System memory

1.7.1 Overview

The motherboard comes with four Double Data Rate 2 (DDR2) Dual Inline Memory Modules (DIMM) sockets. The figure illustrates the location of the DDR2 DIMM sockets:

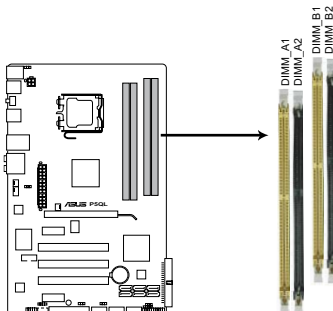

Channel	Sockets
Channel A	DIMM_A1 and DIMM_A2
Channel B	DIMM_B1 and DIMM_B2

P5QL 240-pin DDR2 DIMM sockets

1.7.2 Memory configurations

You may install 512MB, 1GB, 2GB, and 4GB unbuffered non-ECC DDR2 DIMMs into the DIMM sockets.



-
- You may install varying memory sizes in Channel A and Channel B. The system maps the total size of the lower-sized channel for the dual-channel configuration. Any excess memory from the higher-sized channel is then mapped for the single-channel operation.
 - Always install DIMMs with the same CAS latency. For optimum compatibility, it is recommended that you obtain memory modules from the same vendor.
 - Due to the memory address limitation on 32-bit Windows® OS, when you install 4GB or more memory on the motherboard, the actual usable memory for the OS can be about 3GB or less. For effective use of memory, we recommend that you do either of the following:
 - Install a maximum of 3GB system memory if you are using a 32-bit Windows® OS.
 - Use a 64-bit Windows® OS if you want to install 4GB or more memory on the motherboard.
 - This motherboard does not support DIMMs made up of 256 megabits (Mb) chips or less.



This motherboard supports up to 16GB on Windows® XP Professional x64 and Windows® Vista x64 editions. You may install a maximum of 4GB DIMM on each slot.

P5QL Motherboard Qualified Vendors Lists (QVL)

DDR2-1066MHz capability

Size	Vendor	Part No.	CL	Chip Brand	SS/ DS	Chip No.	DIMM support		
							A*	B*	C*
512MB	Kingston	KHX8500D2/512	N/A	Kingston	SS	Heat-Sink Package	*	*	*
512MB	Kingston	KVR1066D2N7/512	N/A	Elpida	SS	E5108AJBG-1J-E	*	*	*
1G	Kingston	KHX8500D2K2/1GN	N/A	Kingston	DS	Heat-Sink Package	*	*	*
1G	Kingston	KVR1066D2N7/1G	N/A	Elpida	DS	E5108AJBG-1J-E	*	*	*
1G	Kingston	KHX8500D2/1G	N/A	Kingston	DS	Heat-Sink Package	*	*	*
1G	Qimonda	HYS64T128020EU-19F-C	6	Qimonda	DS	HYB18T512800CF19FFSS24313	*	*	*
1G	Kingmax	KLED48F-A8K15	N/A	Kingmax	DS	KKABFFIXF-JFS-18A	*	*	*
1G	Transcend	TX1066QLJ-2GK1GB	5	Transced	DS	Heat-Sink Package	*	*	*
1G	GEIL	GB22GB8500C5DC	5	GEIL	SS	GL2L128M88BA25AB	*	*	*
1G	GEIL	GB24GB8500C5QC	5	GEIL	SS	GL2L128M88BA25AB	*	*	*
1G	GEIL	GE22GB1066C5DC	5	GEIL	DS	Heat-Sink Package	*	*	*
2G	GEIL	GB24GB8500C5DC	5	GEIL	DS	GL2L128M88BA25AB	*	*	*
1G	AENEON	AXT760UD00-19DC97X	5	AENEON	DS	Heat-Sink Package	*	*	*

DDR2-800MHz capability

Size	Vendor	Part No.	CL	Chip Brand	SS/ DS	Chip No.	DIMM support		
							A*	B*	C*
1G	Kingston	KHX6400D2LL/1G	N/A	Kingston	DS	Heat-Sink Package	*	*	*
512MB	Kingston	KHX6400D2LLK2/1GN	N/A	Kingston	SS	Heat-Sink Package	*	*	*
512MB	Kingston	KVR800D2N5/512	N/A	Promos	SS	V59C151280QCF25SY032406PECPA	*	*	*
512MB	Kingston	KVR800D2N6/512	N/A	Elpida	SS	E5108AJBG-8E-E	*	*	*
1G	Kingston	KVR800D2N5/1G	N/A	Elpida	DS	E5108AJBG-8E-E	*	*	*
1G	Kingston	KVR800D2N6/1G	N/A	Elpida	DS	E5108AJBG-8E-E	*	*	*
2G	Kingston	KVR800D2N5/2G	N/A	Elpida	DS	E1108ACBG-8E-E	*	*	*
4G	Kingston	N/A	N/A	Elpida	DS	E2108ABSE-8G-E	*	*	*
512MB	Samsung	M378T6553GZS-CF7	6	Samsung	SS	K4T51083QQ-HCF7	*	*	*
1G	Samsung	M378T2863QZS-CF7	6	Samsung	SS	K4T1G084QQ-HCF7	*	*	*
1G	Samsung	M378T2953GZ3-CF7	6	Samsung	DS	K4T51083QQ-HCF7	*	*	*
2G	Samsung	M378T5663QZ3-CF7	6	Samsung	DS	K4T1G084QQ-HCF7	*	*	*
512MB	Qimonda	HYS64T64000EU-2.5-B2	6	Qimonda	SS	HYB18T512800B2F25FSS28380	*	*	*
1G	Corsair	XMS2-6400	4	Corsair	DS	Heat-Sink Package	*	*	*
1G	Corsair	XMS2-6400	5	Corsair	DS	Heat-Sink Package	*	*	*
512MB	HY	HYP564U64CP8-S5 AB	5	Hynix	SS	HYP5P12821CFP-S5	*	*	*
1G	HY	HYP5612U64CP8-S5 AB	5	Hynix	DS	HYP5P12821CFPPS5	*	*	*
512MB	Kingmax	KLDC28F-A8K15	N/A	Kingmax	SS	KKAB811XF-JFS-25A	*	*	*
1G	Kingmax	KLDD48F-A8K15	N/A	Kingmax	DS	KKAB8FFIXF-HFS-25A	*	*	*
512MB	Apacer	78.91G91.9K5	5	Apacer	SS	AM4B5708LQJ8E0751C	*	*	*
1G	Apacer	78.01GA0.9K5	5	Apacer	SS	AM4B5808CQJS8E0749D	*	*	*
2G	Apacer	78.A1GA0.9K4	5	Apacer	DS	AM4B5808CQJS8E0747D	*	*	*
512MB	Transcend	TS128MLQ64V8J512MB	N/A	Micron	SS	7HD22 D9GMH	*	*	*
512MB	Transcend	TS64MLQ64V8J512MB	N/A	Transcend	SS	Heat-Sink Package	*	*	*
512MB	ADATA	M20AD6G3H3160Q1E58	N/A	ADATA	SS	AD29608A8A-25EG80812	*	*	*
512MB	VDATA	M2GV06G3H3160Q1E52	N/A	VDATA	SS	VD29608A8A-25EG20813	*	*	*
1G	ADATA	M20AD6G314170Q1E58	N/A	ADATA	DS	AD29608A8A-25EG80810	*	*	*
1G	VDATA	M2GV06G314170Q1E58	N/A	VDATA	DS	VD29608A8A-25EG80813	*	*	*
1G	PSC	AL7E8F73C-8E1	5	PSC	SS	A3R1GE3CF734MAA0E	*	*	*
2G	PSC	AL8E8F73C-8E1	5	PSC	DS	A3R1GE3CF734MAA0E	*	*	*
1G	GEIL	GB22GB6400C4DC	4	GEIL	DS	GL2L64M088BA30EB	*	*	*
1G	GEIL	GB24GB6400C4QC	4	GEIL	DS	GL2L64M088BA30EB	*	*	*
1G	GEIL	GB22GB6400C5DC	5	GEIL	DS	GL2L64M088BA30EB	*	*	*
1G	GEIL	GB24GB6400C5QC	5	GEIL	DS	GL2L64M088BA30EB	*	*	*
1G	GEIL	GX22GB6400DC	5	GEIL	DS	Heat-Sink Package	*	*	*
1G	GEIL	GE22GB800C4DC	4	GEIL	DS	Heat-Sink Package	*	*	*
1G	GEIL	GE24GB800C4QC	4	GEIL	DS	Heat-Sink Package	*	*	*
1G	GEIL	GX22GB6400UDC	4	GEIL	DS	Heat-Sink Package	*	*	*
1G	GEIL	GE22GB800C5DC	5	GEIL	DS	Heat-Sink Package	*	*	*
1G	GEIL	GE24GB800C5QC	5	GEIL	DS	Heat-Sink Package	*	*	*
2G	GEIL	GB24GB6400C4DC	4	GEIL	DS	GL2L128M88BA25AB	*	*	*

(continued on the next page)

DDR2-800MHz capability

Size	Vendor	Part No.	CL	Chip Brand	SS/DS	Chip No.	DIMM support		
							A*	B*	C*
2G	GEIL	GB24GB6400C5DC	5	GEIL	DS	GL2L128M88BA25AB	*	*	*
2G	GEIL	GB28GB6400C5QC	5	GEIL	DS	GL2L128M88BA25AB	*	*	*
2G	GEIL	GX22GB6400LX	5	GEIL	DS	Heat-Sink Package	*	*	*
2G	GEIL	GX24GB6400DC	5	GEIL	DS	Heat-Sink Package	*	*	*
2G	GEIL	GE28GB800C5QC	5	GEIL	DS	Heat-Sink Package	*	*	*
2G	GEIL	GE28GB800C4QC	4	GEIL	DS	Heat-Sink Package	*	*	*
2G	GEIL	GX22GB6400CJUC	4	GEIL	DS	Heat-Sink Package	*	*	*
2G	GEIL	GE24GB800C4DC	4	GEIL	DS	Heat-Sink Package	*	*	*
1G	Super Talent	T800U1G04	4	Super Talent	DS	Heat-Sink Package	*	*	*
1G	G.SKILL	F2-6400CL5D-2GBNQ	5	G.SKILL	DS	Heat-Sink Package	*	*	*
1G	G.SKILL	F2-6400CL4D-2GBPK	4	G.SKILL	DS	Heat-Sink Package	*	*	*
1G	G.SKILL	F2-6400CL4D-2GBHK	4	G.SKILL	DS	Heat-Sink Package	*	*	*
2G	G.SKILL	F2-6400CL5D-4GBPQ	5	G.SKILL	DS	Heat-Sink Package	*	*	*
2G	G.SKILL	F2-6400CL4D-4GBPK	4	G.SKILL	DS	Heat-Sink Package	*	*	*
1G	OCZ	OCZ2RPR8002GK	4	OCZ	DS	Heat-Sink Package	*	*	*
1G	OCZ	OCZ2G800R22GK	5	OCZ	DS	Heat-Sink Package	*	*	*
1G	OCZ	OCZ2P800R22GK	4	OCZ	DS	Heat-Sink Package	*	*	*
1G	OCZ	OCZ2VU8004GK	6	OCZ	DS	Heat-Sink Package	*	*	*
1G	Elixir	M2Y1G64TU8HB0B-25C	5	Elixir	DS	N2TU51280BE-25C802006Z1DV	*	*	*
1G	AENEON	AET760UD00-25DB97X	5	AENEON	DS	AET93R25DB 0640	*	*	*
1G	AENEON	AET760UD00-25DC08X	5	AENEON	SS	AET03R250C 0732	*	*	*
2G	AENEON	AET860UD00-25DC08X	5	AENEON	DS	AET03R250C 0732	*	*	*
512MB	MDT	MDT 512MB	5	MDT	SS	18D51280D-2.50726F	*	*	*
1G	Century	28V0H8	5	Hynix	DS	HY5PS12821CFP-S5	*	*	*
512MB	TAKEMS	TMS51B264C081-805EP	5	takeMS	SS	MS18T51280-2.5P0710	*	*	*
1G	TAKEMS	TMS1GB264C081-805EP	5	takeMS	DS	MS18T51280-2.5P0716	*	*	*
1G	ASINT	SLY2128MB-JGE	N/A	ASINT	SS	DDR1I1208-GE 8115	*	*	*
2G	ASINT	SLZ2128MB-JGE	N/A	ASINT	DS	DDR1I1208-GE 8115	*	*	*
1G	UMAX	D48001GP3-63BJU	N/A	UMAX	DS	U2S12D30TP-8E	*	*	*

DDR2-667MHz capability

Size	Vendor	Part No.	CL	Chip Brand	SS/DS	Chip No.	DIMM support		
							A*	B*	C*
512MB	Kingston	KVR667D2N5/512	N/A	Hynix	SS	HY5PS12821EFP-Y5	*	*	*
1G	Kingston	KVR667D2N5/1G	N/A	Hynix	SS	HY5PS12821EFP-Y5	*	*	*
2G	Kingston	KVR667D2N5/2G	N/A	Micron	DS	7RE22 D9HNL	*	*	*
512MB	Qimonda	HYS64T64000EU-3S-B2	5	Qimonda	SS	HYB18T512B00B2F3SFSS28171	*	*	*
1G	Qimonda	HYS64T128020EU-3S-B2	5	Qimonda	DS	HYB18T512B00B2F3SFSS28171	*	*	*
512MB	Corsair	VS512MB667D2	N/A	Corsair	SS	64M8CFEGP9000647	*	*	*
1G	Corsair	VS1GB667D2	N/A	Corsair	DS	MID095D62864M8CEC	*	*	*
1G	Corsair	XMS2-5400	4	Corsair	DS	Heat-Sink Package	*	*	*
1G	HY	HYMP512U64CP8-Y5 AB	5	Hynix	DS	HY5PS12521CFP-Y5	*	*	*
512MB	Kingmax	KLCC28F-A8KB5	N/A	Kingmax	SS	KKEA88B4LAUG-29DX	*	*	*
1G	Kingmax	KLCC48F-A8KB5	N/A	Kingmax	DS	KKEA88B4LAUG-29DX	*	*	*
512MB	Apacer	AU512E667C5KBGC	5	Apacer	SS	AM4B5708MUJS7E0627B	*	*	*
512MB	Apacer	AU512E667C5KBGC	5	Apacer	SS	AM4B5708GQJS7E06332F	*	*	*
512MB	Apacer	78.91G92.9K5	5	Apacer	SS	AM4B5708JQJS7E0751C	*	*	*
1G	Apacer	78.01G90.9K5	5	Apacer	SS	AM4B5808CQJS7E0751C	*	*	*
1G	Apacer	AU01GE667C5KBGC	N/A	Apacer	DS	AM4B5708GQJS7E0636B	*	*	*
1G	Apacer	AU01GE667C5KBGC	5	Apacer	DS	AM4B5708MUJS7E0627B	*	*	*
2G	Apacer	78.A1G90.9K4	5	Apacer	DS	AM4B5808CQJS7E0749B	*	*	*
1G	Transcend	506010-4894	5	Elpida	DS	E5108AJBG-6E-E	*	*	*
512MB	ADATA	M2QAD5G3H3160Q1C52	N/A	ADATA	SS	AD29608A8A-3EG20813	*	*	*
2G	ADATA	M2QAD5H3J4170H1C53	N/A	ADATA	DS	AD20908A8A-3EG 30724	*	*	*
512MB	PSC	AL6E8E63J-6E1	5	PSC	SS	A3R12E3JFF717B9A00	*	*	*
1G	PSC	AL7E8E63J-6E1	5	PSC	DS	A3R12E3JFF717B9A01	*	*	*
1G	PSC	AL7E8F73C-6E1	5	PSC	SS	A3R1GE3CF734MAA0J	*	*	*
2G	PSC	AL8E8F73C-6E1	5	PSC	DS	A3R1GE3CF733MAA00	*	*	*
512MB	Nanya	NT512T64U88A1BY-3C	N/A	Nanya	SS	NT5TU64M8AE-3C	*	*	*
1G	Nanya	NT1GT64U8HB0BY-3C	5	Nanya	DS	NT5TU64M8BE-3C72155700CP	*	*	*
1G	GEIL	GX21GB5300SX	3	GEIL	DS	Heat-Sink Package	*	*	*

(continued on the next page)

DDR2-667MHz capability

Size	Vendor	Part No.	CL	Chip Brand	SS/ DS	Chip No.	DIMM support		
							A*	B*	C*
2G	GEIL	GX24GB5300LDC	5	GEIL	DS	Heat-Sink Package	•	•	•
1G	Super Talent	T667UB1GV	5	Super Talent	DS	PG 64MB-800 0750	•	•	•
512MB	Twinmos	8D-A3JK5MPETP	5	PSC	SS	A3R12E3GEF633ACAOY	•	•	•
1G	ELIXIR	M2Y1G64TU8HA2B-3C	5	ELIXIR	DS	M2TU51280AE-3C717095R28F	•	•	•
1G	ELIXIR	M2Y1G64TU8HB0B-3C	5	ELIXIR	DS	N2TU51280BE-3C639009W1CF	•	•	•
1G	Leadmax	LRMP512U64A8-Y5	N/A	Hynix	DS	HY5PS12821CFP-Y5 C 702AA	•	•	•
512MB	MDT	DDRll 512 PC667	4	MDT	DS	18D51201D-30726E	•	•	•
1G	MDT	MDT 1024MB	4	MDT	DS	18D51200D-30646	•	•	•
1G	MDT	MDT 1024MB	4	MDT	DS	18D51280D-30646E	•	•	•
512MB	AENEON	AET660UD00-30DB97X	5	AENEON	SS	AET93R300B 0634	•	•	•
1G	AENEON	AET760UD00-30DB97X	5	AENEON	DS	AET93R300B 0639	•	•	•
512MB	TAKEMS	TMS51B264C081-665QI	5	takeMS	SS	MS18T51280-3	•	•	•
512MB	TAKEMS	TMS51B264C081-665AP	5	takeMS	SS	MS18T51280-3S0627D	•	•	•
1G	TAKEMS	TMS1GB264C081-665AE	5	takeMS	DS	MS18T51280-3SEA07100	•	•	•
512MB	ASINT	SLX264M8-J6E	N/A	ASINT	SS	DDRll6408-6E	•	•	•
1G	ASINT	Sly2128M8-J6E	N/A	ASINT	SS	DDRll1208-6E 8115	•	•	•
512MB	Century	CENTURY 512MB	N/A	Nanya	SS	NT5TU64M8AE-3C	•	•	•
512MB	Century	CENTURY 512MB	N/A	Hynix	SS	HY5PS12821AFP-Y5	•	•	•
1G	Century	CENTURY 1G	N/A	Hynix	DS	HY5PS12821AFP-Y5	•	•	•
1G	UMAX	D46701GP3-63BJU	N/A	UMAX	DS	U2S12D30YP-6E	•	•	•
2G	UMAX	D46702GP0-73BCU	5	UMAX	DS	U2S24D30TP-6E	•	•	•
512MB	KINGBOX	512MB 667MHz	N/A	KINGBOX	SS	EPD264082200-4	•	•	•



SS - Single-sided / DS - Double - sided

DIMM support:

- **A*:** Supports one module inserted into any slot as Single-channel memory configuration.
- **B*:** Supports one pair of modules inserted into either the yellow or the black slots as one pair of Dual-channel memory configuration.
- **C*:** Supports four modules inserted into both the yellow and black slots as two pairs of Dual-channel memory configuration.



Visit the ASUS website at www.asus.com for the latest QVL.

1.7.3 Installing a DIMM



Unplug the power supply before adding or removing DIMMs or other system components. Failure to do so can cause severe damage to both the motherboard and the components.

To install a DIMM:

1. Press the retaining clips outward to unlock a DDR2 DIMM socket.
2. Align a DIMM on the socket such that the notch on the DIMM matches the break on the socket.

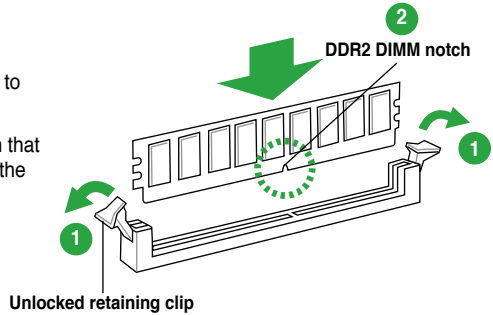

A DDR2 DIMM is keyed with a notch so that it fits in only one direction. DO NOT force a DIMM into a socket to avoid damaging the DIMM.

3. Firmly insert the DIMM into the socket until the retaining clips snap back in place and the DIMM is properly seated.

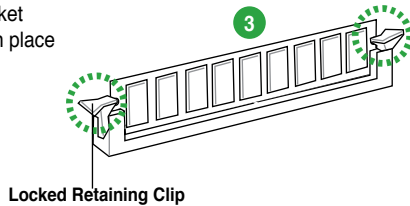

1.7.4 Removing a DIMM

To remove a DIMM:

1. Simultaneously press the retaining clips outward to unlock the DIMM.



Support the DIMM lightly with your fingers when pressing the retaining clips. The DIMM might get damaged when it flips out with extra force.

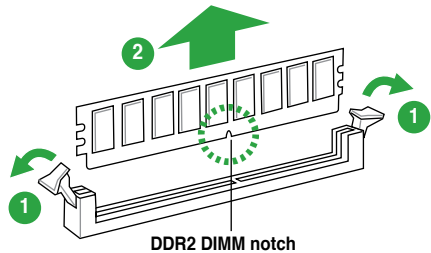

2. Remove the DIMM from the socket.

1.8 Expansion slots

In the future, you may need to install expansion cards. The following sub-sections describe the slots and the expansion cards that they support.



Unplug the power cord before adding or removing expansion cards. Failure to do so may cause you physical injury and damage motherboard components.

1.8.1 Installing an expansion card

To install an expansion card:

1. Before installing the expansion card, read the documentation that came with it and make the necessary hardware settings for the card.
2. Remove the system unit cover (if your motherboard is already installed in a chassis).
3. Remove the bracket opposite the slot that you intend to use. Keep the screw for later use.
4. Align the card connector with the slot and press firmly until the card is completely seated on the slot.
5. Secure the card to the chassis with the screw you removed earlier.
6. Replace the system cover.

1.8.2 Configuring an expansion card

After installing the expansion card, configure it by adjusting the software settings.

1. Turn on the system and change the necessary BIOS settings, if any. See Chapter 2 for information on BIOS setup.
2. Assign an IRQ to the card.
3. Install the software drivers for the expansion card.



When using PCI cards on shared slots, ensure that the drivers support "Share IRQ" or that the cards do not need IRQ assignments. Otherwise, conflicts will arise between the two PCI groups, making the system unstable and the card inoperable.

1.8.3 PCI slots

The PCI slots support cards such as a LAN card, SCSI card, USB card, and other cards that comply with PCI specifications.

1.8.4 PCI Express x1 slots

This motherboard supports PCI Express x1 network cards, SCSI cards, and other cards that comply with the PCI Express specifications.

1.8.5 PCI Express x16 slot

This motherboard supports a PCI Express x16 graphics card that complies with the PCI Express specifications.

1.9 Jumpers

1. Clear RTC RAM (3-pin CLRTC)

This jumper allows you to clear the Real Time Clock (RTC) RAM in CMOS. You can clear the CMOS memory of date, time, and system setup parameters by erasing the CMOS RTC RAM data. The onboard button cell battery powers the RAM data in CMOS, which include system setup information such as system passwords.

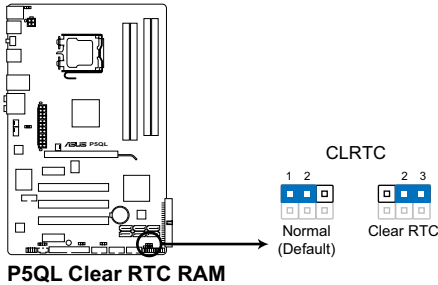

To erase the RTC RAM:

1. Turn OFF the computer and unplug the power cord.
2. Move the jumper cap from pins 1-2 (default) to pins 2-3. Keep the cap on pins 2-3 for about 5-10 seconds, then move the cap back to pins 1-2.
3. Plug the power cord and turn ON the computer.
4. Hold down the key during the boot process and enter BIOS setup to re-enter data.



Except when clearing the RTC RAM, never remove the cap on CLRTC jumper default position. Removing the cap will cause system boot failure!



- If the steps above do not help, remove the onboard battery and move the jumper again to clear the CMOS RTC RAM data. After clearing the CMOS, reinstall the battery.
 - You do not need to clear the RTC when the system hangs due to overclocking. For system failure due to overclocking, use the CPU Parameter Recall (C.P.R.) feature. Shut down and reboot the system, then the BIOS automatically resets parameter settings to default values.
 - Due to the chipset limitation, AC power off is required before you use the C.P.R. function. You must turn off and on the power supply or unplug and plug the power cord before rebooting the system.
-

2. Keyboard/mouse power (3-pin PS2_USBPW56)

This jumper allows you to enable or disable the keyboard/mouse and USB port 5-6 wake-up feature. When you set this jumper to pins 2-3 (+5VSB), you can wake up the computer by pressing a key on the keyboard (the default is the Space Bar), clicking the mouse, or using a USB device. This feature requires an ATX power supply that can supply at least 1A on the +5VSB lead, and a corresponding setting in the BIOS. The USBPW56 jumper is for the rear USB ports.

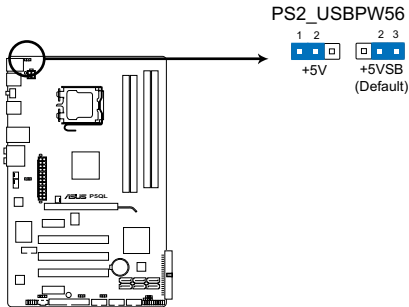

P5QL Keyboard/Mouse power

3. USB device wake-up (3-pin USBPW1-4, USBPW7-10, USBPW1112)

Set these jumpers to +5V to wake up the computer from S1 sleep mode (CPU stopped, DRAM refreshed, system running in low power mode) using the connected USB devices. Set to +5VSB to wake up from S3 and S4 sleep modes (no power to CPU, DRAM in slow refresh, power supply in reduced power mode).

The USBPW1-4 and PS2_USBPW56 jumpers are for the rear USB ports. The USBPW7-10 and USB1112 jumpers are for the internal USB connectors that you can connect to additional USB ports.

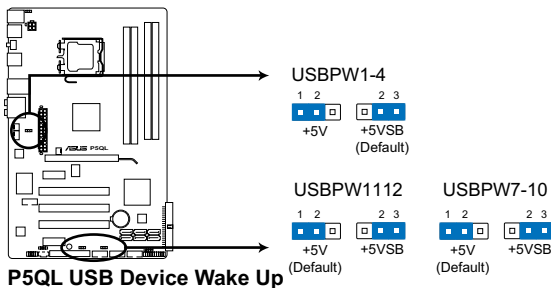

P5QL USB Device Wake Up



- The USB device wake-up feature requires a power supply that can provide 500mA on the +5VSB lead for each USB port; otherwise, the system would not power up.
- The total current consumed must NOT exceed the power supply capability (+5VSB) whether under normal condition or in sleep mode.

1.10 Connectors

1.10.1 Rear panel connectors

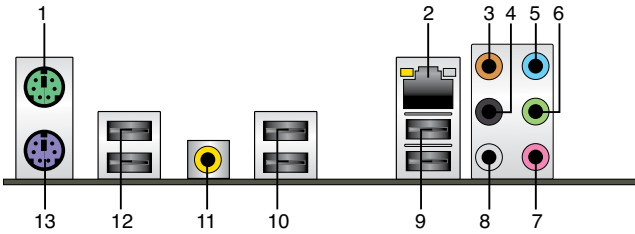

1. **PS/2 mouse port (green).** This port is for a PS/2 mouse.
2. **LAN (RJ-45) port.** Supported by Gigabit LAN controller, this port allows Gigabit connection to a Local Area Network (LAN) through a network hub. Refer to the table below for the LAN port LED indications.

LAN port LED indications

ACT/LINK LED		SPEED LED	
Status	Description	Status	Description
OFF	No link	OFF	10 Mbps connection
YELLOW	Linked	ORANGE	100 Mbps connection
BLINKING	Data activity	GREEN	1 Gbps connection

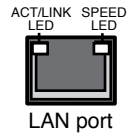

3. **Center/Subwoofer port (orange).** This port connects the center/subwoofer speakers.
4. **Rear Speaker Out port (black).** This port connects the rear speakers in a 4-channel, 6-channel, or 8-channel audio configuration.
5. **Line In port (light blue).** This port connects the tape, CD, DVD player, or other audio sources.
6. **Line Out port (lime).** This port connects a headphone or a speaker. In 4-channel, 6-channel, and 8-channel configuration, the function of this port becomes Front Speaker Out.
7. **Microphone port (pink).** This port connects a microphone.
8. **Side Speaker Out port (gray).** This port connects the side speakers in an 8-channel audio configuration.



Refer to the audio configuration table on the next page for the function of the audio ports in 2, 4, 6, or 8-channel configuration.

Audio 2, 4, 6, or 8-channel configuration

Port	Headset 2-channel	4-channel	6-channel	8-channel
Light Blue	Line In	Line In	Line In	Line In
lime	Line Out	Front Speaker Out	Front Speaker Out	Front Speaker Out
Pink	Mic In	Mic In	Mic In	Mic In
Orange	–	–	Center/Subwoofer	Center/Subwoofer
Black	–	Rear Speaker Out	Rear Speaker Ou	Rear Speaker Out
Gray	–	–	–	Side Speaker Out

- USB 2.0 ports 1 and 2.** These two 4-pin Universal Serial Bus (USB) ports are available for connecting USB 2.0 devices.
- USB 2.0 ports 3 and 4.** These two 4-pin Universal Serial Bus (USB) ports are available for connecting USB 2.0 devices.
- Coaxial S/PDIF Out port.** This port connects an external audio output device via a coaxial S/PDIF cable.
- USB 2.0 ports 5 and 6.** These two 4-pin Universal Serial Bus (USB) ports are available for connecting USB 2.0 devices.
- PS/2 keyboard port (purple).** This port is for a PS/2 keyboard.

1.10.2 Internal connectors

1. Floppy disk drive connector (34-1 pin FLOPPY)

This connector is for a floppy disk drive (FDD) signal cable. Connect one end of a FDD cable to this connector and the other end to the signal connector at the back of the floppy disk drive.



- Pin 5 on the connector is removed to prevent incorrect cable connection when using a FDD cable with a covered Pin 5.
- The FDD cable is purchased separately.

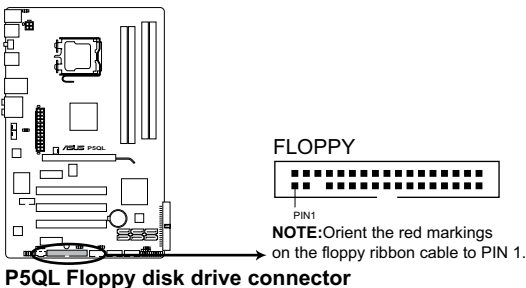

2. Digital audio connector (4-1 pin SPDIF_OUT)

This connector is for an additional Sony/Philips Digital Interface (S/PDIF) port. Connect the S/PDIF Out module cable to this connector, then install the module to a slot opening at the back of the system chassis.

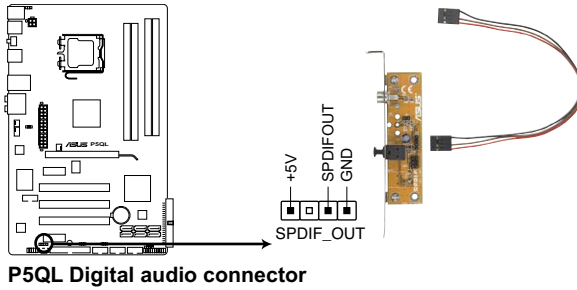

The S/PDIF module is purchased separately.

3. Serial ATA connectors (7-pin SATA1-6)

These connectors are for the Serial ATA signal cables for Serial ATA hard disk drives.

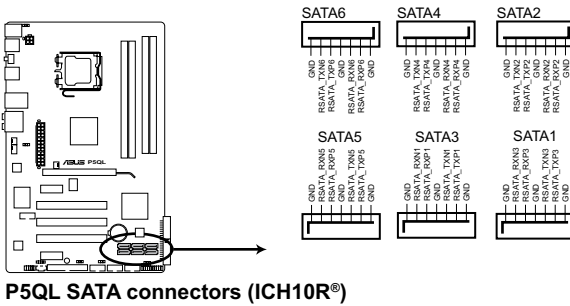

Connect the right-angle side of SATA signal cable to SATA device. Or you may connect the right-angle side of SATA cable to the onboard SATA port to avoid mechanical conflict with huge graphics cards.

right angle side

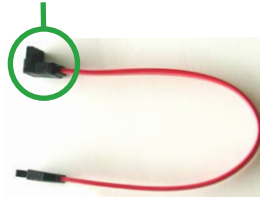

4. IDE connector (40-1 pin PRI_IDE)

The onboard IDE connector is for an Ultra DMA 133/100/66 signal cable. There are three connectors on each Ultra DMA 133/100/66 signal cable: blue, black, and gray. Connect the blue connector to the motherboard's IDE connector, then select one of the following modes to configure your device.

	Drive jumper setting	Mode of device(s)	Cable connector
Single device	Cable-Select or Master	-	Black
Two devices	Cable-Select	Master	Black
		Slave	Gray
	Master	Master	Black or gray
Slave	Slave		



- Pin 20 on the IDE connector is removed to match the covered hole on the Ultra DMA cable connector. This prevents incorrect insertion when you connect the IDE cable.
- Use the 80-conductor IDE cable for Ultra DMA 133/100/66 IDE devices.



If any device jumper is set as "Cable-Select," make sure all other device jumpers have the same setting.

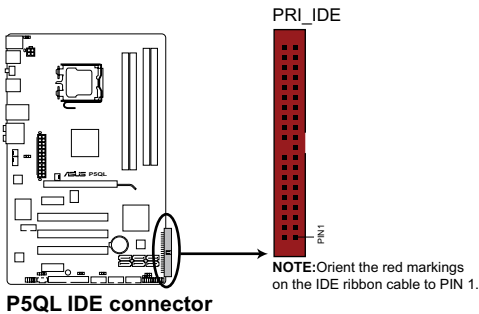

5. Optical drive audio connector (4-pin CD)

This connector allows you to receive stereo audio input from sound sources such as a CD-ROM, TV tuner, or MPEG card.

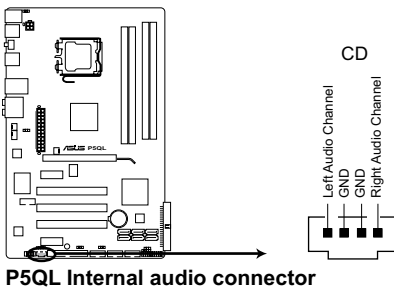

6. CPU, chassis, and power fan connectors (4-pin CPU_FAN, 3-pin CHA_FAN, 3-pin PWR_FAN)

The fan connectors support cooling fans of 350 mA~2000 mA (24 W max.) or a total of 1 A~7 A (84 W max.) at +12V. Connect the fan cables to the fan connectors on the motherboard, making sure that the black wire of each cable matches the ground pin of the connector.



Do not forget to connect the fan cables to the fan connectors. Insufficient air flow inside the system may damage the motherboard components. These are not jumpers! Do not place jumper caps on the fan connectors!

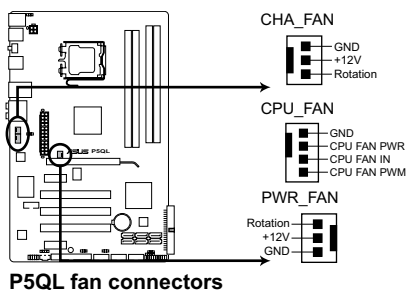

Only the CPU fan supports the ASUS Q-FAN feature.

7. Chassis intrusion connector (4-1 pin CHASSIS)

This connector is for a chassis-mounted intrusion detection sensor or switch. Connect one end of the chassis intrusion sensor or switch cable to this connector. The chassis intrusion sensor or switch sends a high-level signal to this connector when a chassis component is removed or replaced. The signal is then generated as a chassis intrusion event.

By default, the pin labeled “Chassis Signal” and “Ground” are shorted with a jumper cap. Remove the jumper caps only when you intend to use the chassis intrusion detection feature.

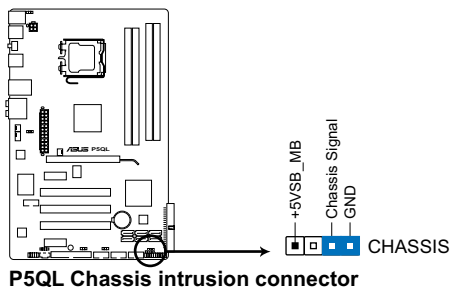

8. Front panel audio connector (10-1 pin AAFP)

This connector is for a chassis-mounted front panel audio I/O module that supports either HD Audio or legacy AC'97 audio standard. Connect one end of the front panel audio I/O module cable to this connector.

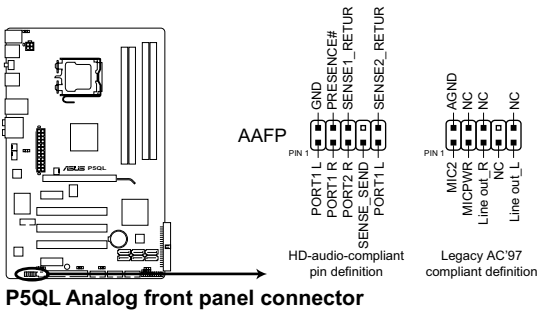

- We recommend that you connect a high-definition front panel audio module to this connector to avail of the motherboard's high-definition audio capability.
- If you want to connect a high-definition front panel audio module to this connector, set the **Front Panel Type** item in the BIOS to **[HD Audio]**; if you want to connect an AC'97 front panel audio module to this connector, set the item to **[AC97]**. By default, this connector is set to **[HD Audio]**. See section 2.5.3 **Onboard Devices Configuration** for details.

9. Serial port connector (10-1 pin COM1)

This connector is for a serial (COM) port. Connect the serial port module cable to this connector, then install the module to a slot opening at the back of the system chassis.

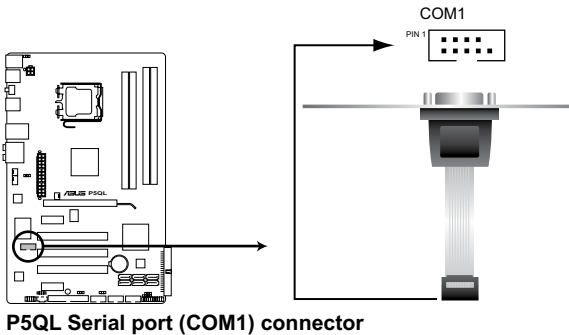

The serial port module is purchased separately.

10. USB connectors (10-1 pin USB78, USB910, USB1112)

These connectors are for USB 2.0 ports. Connect the USB module cable to any of these connectors, then install the module to a slot opening at the back of the system chassis. These USB connectors comply with USB 2.0 specification that supports up to 480 Mbps connection speed.

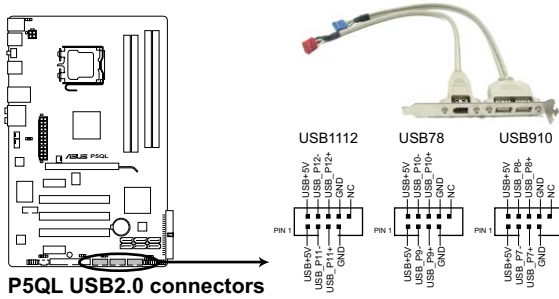

P5QL USB2.0 connectors



Never connect a 1394 cable to the USB connectors. Doing so damages the motherboard!



The USB module is purchased separately.

11. ATX power connectors (24-pin EATXPWR, 4-pin ATX12V)

These connectors are for ATX power supply plugs. The power supply plugs are designed to fit these connectors in only one orientation. Find the proper orientation and push down firmly until the connectors completely fit.

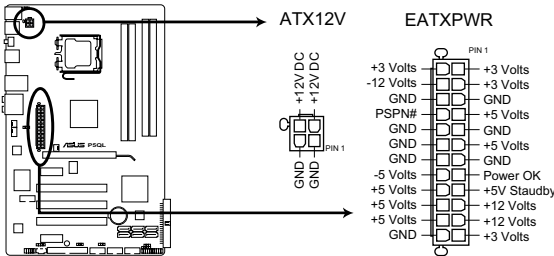

P5QL ATX power connectors



- For a fully configured system, we recommend that you use a power supply unit (PSU) that complies with ATX 12 V Specification 2.0 (or later version) and provides a minimum power of 400W.
- Do not forget to connect the 4-pin EATX12V power plug; otherwise, the system will not boot.
- Use of a PSU with a higher power output is recommended when configuring a system with more power-consuming devices. The system may become unstable or may not boot up if the power is inadequate.
- The ATX 12 V Specification 2.0-compliant (400W) PSU has been tested to support the motherboard power requirements with the following configuration:
CPU: Intel® Pentium® Extreme 3.73GHz / Memory: 512 MB DDR2 (x4) / Graphics card: ASUS EAX1900XT / Parallel ATA device: IDE hard disk drive / Serial ATA device: SATA hard disk drive (x2) / Optical drive: DVD-RW

12. System panel connector (20-8 pin PANEL)

This connector supports several chassis-mounted functions.

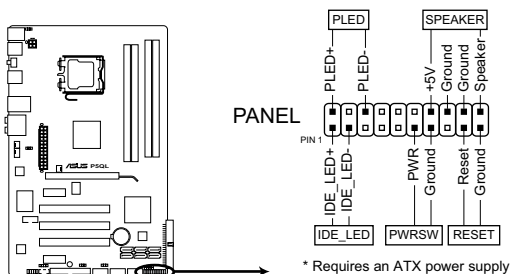

P5QL System panel connector

- **System power LED (2-pin PLED)**

This 2-pin connector is for the system power LED. Connect the chassis power LED cable to this connector. The system power LED lights up when you turn on the system power, and blinks when the system is in sleep mode.

- **Hard disk drive activity LED (2-pin IDE_LED)**

This 2-pin connector is for the HDD Activity LED. Connect the HDD Activity LED cable to this connector. The IDE LED lights up or flashes when data is read from or written to the HDD.

- **System warning speaker (4-pin SPEAKER)**

This 4-pin connector is for the chassis-mounted system warning speaker. The speaker allows you to hear system beeps and warnings.

- **ATX power button/soft-off button (2-pin PWRSW)**

This connector is for the system power button. Pressing the power button turns the system on or puts the system in sleep or soft-off mode depending on the BIOS settings. Pressing the power switch for more than four seconds while the system is ON turns the system OFF.

- **Reset button (2-pin RESET)**

This 2-pin connector is for the chassis-mounted reset button for system reboot without turning off the system power.

1.11 Software support

1.11.1 Installing an operating system

This motherboard supports Windows® XP/Vista Operating Systems (OS). Always install the latest OS version and corresponding updates to maximize the features of your hardware.



- Motherboard settings and hardware options vary. Refer to your OS documentation for detailed information.
- Ensure that you install Windows® XP Service Pack 3 / Windows® Vista Service Pack 1 before installing the drivers for better compatibility and system stability.

1.11.2 Support DVD information

The Support DVD that comes with the motherboard package contains the drivers, software applications, and utilities that you can install to avail all motherboard features.



The contents of the Support DVD are subject to change at any time without notice. Visit the ASUS website at www.asus.com for updates.

To run the Support DVD

Place the Support DVD into the optical drive. The DVD automatically displays the Drivers menu if Autorun is enabled on your computer.

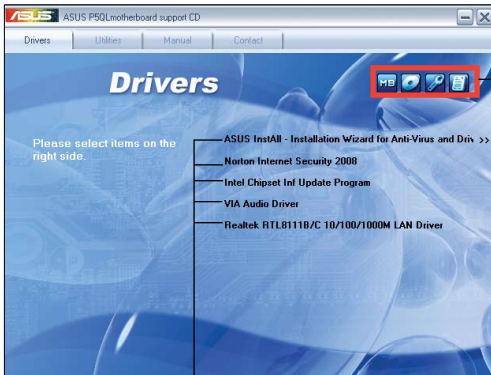

Click an icon to display Support DVD/ motherboard information

Click an item to install



If Autorun is NOT enabled on your computer, browse the contents of the Support DVD to locate the file **ASSETUP.EXE** from the **BIN** folder. Double-click **ASSETUP.EXE** to run the DVD.

Chapter 2

BIOS information

2.1 Managing and updating your BIOS



Save a copy of the original motherboard BIOS file to a floppy disk or a USB flash disk in case you need to restore the BIOS in the future. Copy the original motherboard BIOS using the ASUS Update or AFUDOS utilities.

2.1.1 Creating a bootable floppy disk



Create a bootable floppy disk using a different computer.

To create a bootable floppy disk:

1. Insert a formatted, high density 1.44MB floppy disk into the floppy disk drive.
2. Follow the instructions based on your system environment.

DOS environment

- a. At the DOS prompt, type `format A: /s` then press **<Enter>**.

Windows® XP environment

- a. From the Windows® desktop, click **Start > My Computer**.
- b. Select the 3 1/2 Floppy Drive icon.
- c. Click **File** from the menu bar, then select **Format**. A **Format 3 1/2 Floppy** window appears.
- d. Select **Create an MS-DOS startup disk** from the format options field, then click **Start**.

Windows® Vista environment

- a. From the Windows® desktop, click  **> Computer**.
- b. Right-click **Floppy Disk Drive** then click **Format** to display the **Format 3 1/2 Floppy** dialog box.
- c. Select the **Create an MS-DOS startup disk** check box.
- d. Click **Start**.

2.1.2 ASUS Update utility

The ASUS Update is a utility that allows you to manage, save, and update the motherboard BIOS in Windows® environment.



-
- ASUS Update requires an Internet connection either through a network or an Internet Service Provider (ISP).
 - This utility is available in the Support DVD that comes with the motherboard package.
-

Installing ASUS Update

To install ASUS Update:

1. Place the Support DVD into the optical drive. The **Drivers** menu appears.
2. Click the **Utilities** tab, then click **Install ASUS Update**.
3. Follow the onscreen instructions to complete the installation.



Quit all Windows® applications before you update the BIOS using this utility.

Updating the BIOS

To update the BIOS:

1. From the Windows® desktop, click **Start > Programs > ASUS > ASUSUpdate > ASUSUpdate** to launch the ASUS Update utility.
2. From the dropdown list, select either of the updating processes:

Updating from the Internet

- a. Select **Update BIOS from the Internet**, then click **Next**.
- b. Select the ASUS FTP site nearest you to avoid network traffic, or click **Auto Select** then click **Next**.
- c. From the FTP site, select the BIOS version that you want to download then click **Next**.



The ASUS Update utility is capable of updating itself through the Internet. Always update the utility to get all its features.

Updating from a BIOS file

- a. Select **Update BIOS from a file**, then click **Next**.
 - b. Locate the BIOS file from the **Open** window, then click **Open**.
3. Follow the onscreen instructions to complete the updating process.

2.1.3 ASUS EZ Flash 2 utility

The ASUS EZ Flash 2 feature allows you to update the BIOS without using an OS-based utility.



Download the latest BIOS file from the ASUS website at www.asus.com.

To update the BIOS using EZ Flash 2:

1. Insert the floppy disk or the USB flash disk that contains the latest BIOS file to the floppy disk drive or a USB port, then launch EZ Flash 2 in either of these two ways:
 - Press **<Alt> + <F2>** during POST to display the following:

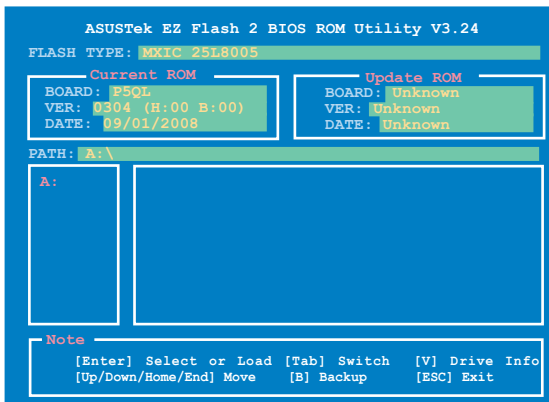

- Enter the BIOS setup program. Go to the **Tools** menu to select **EZ Flash 2** and press **<Enter>** to enable it.
2. Press **<Tab>** to locate the correct BIOS file. Press **<Enter>**.

When the correct BIOS file is found, EZ Flash 2 performs the BIOS updating process and automatically reboots the system when done.



- Only a USB flash disk with **FAT 32/16** format and single partition supports the ASUS EZ Flash 2 utility.
 - **DO NOT** shut down or reset the system while updating the BIOS to prevent system boot failure!
-

2.1.4 AFUDOS utility

The AFUDOS utility allows you to update the BIOS file in DOS environment using a bootable floppy disk. This utility also allows you to copy the current BIOS file that you can use as backup when the BIOS fails or gets corrupted during the updating process.



- Ensure that you prepare two floppy disks: the bootable floppy disk and the floppy disk containing the AFUDOS utility and the latest BIOS file.
- Ensure that the floppy disk is not write-protected and has enough space to save both the AFUDOS and BIOS files.
- The succeeding BIOS screens are for reference only. The actual BIOS screen displays may not be the same as shown.

Updating the BIOS file

To update the BIOS file using the AFUDOS utility:

1. Insert the bootable floppy disk into the floppy disk drive to boot the system in DOS mode.
2. Replace the bootable floppy disk and insert the floppy disk that contains the AFUDOS utility and the latest BIOS file.



- Obtain the AFUDOS utility (afudos.exe) from the bundled support DVD and the latest BIOS file from the ASUS website at www.asus.com.
- We recommend that you write the BIOS filename on a piece of paper. You will need to key in the exact BIOS filename at the DOS prompt later.

3. At the DOS prompt, key in `afudos /i [filename]` where [filename] is the BIOS file in the floppy disk.

```
A:\>afudos /iP5QL.ROM
```

Press **<Enter>**.



DO NOT shut down or reset the system while updating the BIOS to prevent system boot failure!

4. The utility returns to the DOS prompt after the BIOS updating process is completed. Reboot the system from the hard disk drive.

2.1.5 ASUS CrashFree BIOS 3 utility

The ASUS CrashFree BIOS 3 is an auto recovery tool that allows you to restore the BIOS file when it fails or gets corrupted during the updating process. You can update a corrupted BIOS file using the motherboard Support DVD, a floppy disk, or a USB flash disk that contains the updated BIOS file.



- Prepare the motherboard Support DVD, the floppy disk, or the USB flash disk containing the updated motherboard BIOS before using this utility.
- Updating from a PATA optical drive is not supported on this motherboard.
- Always connect the SATA cable to the SATA1/2/3/4 connector. Otherwise, the utility will not function.

Recovering the BIOS

To recover the BIOS:

1. Turn on the system.
2. Insert the floppy disk, Support DVD, or USB flash disk containing the BIOS file to the disk drive or port.

The utility displays the following message and automatically checks the floppy disk, Support DVD, or USB flash disk for the BIOS file.

```
Bad BIOS checksum. Starting BIOS recovery...  
Checking for floppy...
```

When the BIOS file is found, the utility reads it and starts erasing the corrupted BIOS file.

```
Bad BIOS checksum. Starting BIOS recovery...  
Checking for floppy...  
Floppy found!  
Reading file "P5QL.ROM". Completed.  
Start erasing...
```

3. Restart the system after the utility completes the updating process.



- Only the USB flash disk with FAT 32/16 format and single partition supports ASUS CrashFree BIOS 3. The device size should be smaller than 8GB.
- DO NOT shut down or reset the system while updating the BIOS! Doing so can cause system boot failure!



- The utility automatically checks the floppy disk first. If no floppy disk is found, the utility then checks the optical drive and the USB flash disk.
- The recovered BIOS may not be the latest BIOS version for this motherboard. Download the latest BIOS file from the ASUS website at www.asus.com.

2.2 BIOS setup program

This motherboard supports a programmable Serial Peripheral Interface (SPI) chip that you can update using the provided utility described in section 2.1 **Managing and updating your BIOS**.

Use the BIOS Setup program when you are installing a motherboard, reconfiguring your system, or prompted to “Run Setup.” This section explains how to configure your system using this utility.

Even if you are not prompted to use the Setup program, you can change the configuration of your computer in the future. For example, you can enable the security password feature or change the power management settings. This requires you to reconfigure your system using the BIOS Setup program so that the computer can recognize these changes and record them in the CMOS RAM of the SPI chip.

The SPI chip on the motherboard stores the Setup utility. When you start up the computer, the system provides you with the opportunity to run this program. Press **** during the Power-On Self-Test (POST) to enter the Setup utility; otherwise, POST continues with its test routines.

If you want to enter Setup after POST, reboot the system by doing any of the following procedures:

- Restart using the OS standard shut-down procedure.
- Press **<Ctrl>+<Alt>+** simultaneously.
- Press the reset button on the system chassis.
- Press the power button to turn the system off then back on.



Using the **power button**, **reset button**, or the **<Ctrl>+<Alt>+** keys to force reset from a running operating system can cause damage to your data or system. We recommend that you always shut down the system properly from the operating system.

The Setup program is designed to make it as easy to use as possible. Being a menu-driven program, it lets you scroll through the various sub-menus and make your selections from the available options using the navigation keys.



-
- The default BIOS settings for this motherboard apply to most conditions to ensure optimum performance. If the system becomes unstable after changing any BIOS settings, load the default settings to ensure system compatibility and stability. Select the **Load Setup Defaults** item under the **Exit** menu. See section 2.9 **Exit Menu**.
 - The BIOS setup screens in this section are for reference only. They may not exactly match what you see on your screen.
 - Visit the ASUS website at www.asus.com to download the latest BIOS file for this motherboard.
-

2.2.1 BIOS menu screen

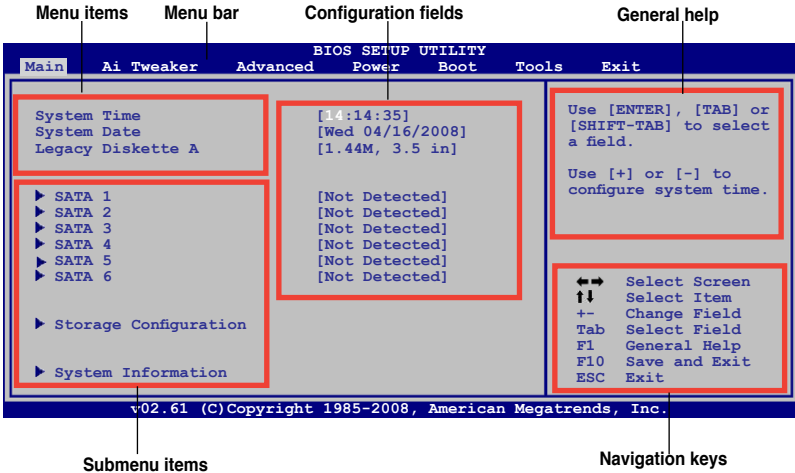

2.2.2 Menu bar

The menu bar on top of the screen has the following main items:

- Main** For changing the basic system configuration
- Ai Tweaker** For configuring system performance settings
- Advanced** For changing the advanced system settings
- Power** For changing the advanced power management (APM) configuration
- Boot** For changing the system boot configuration
- Tools** For configuring options for special functions
- Exit** For selecting the exit options and loading default settings.

To select an item on the menu bar, press the right or left arrow key on the keyboard until the desired item is highlighted.

2.2.3 Navigation keys

At the bottom right corner of a menu screen are the navigation keys for that particular menu. Use the navigation keys to select items in the menu and change the settings.



Some of the navigation keys differ from one screen to another.

2.2.4 Menu items

The highlighted item on the menu bar displays the specific items for that menu. For example, selecting Main shows the Main menu items. The other items (Ai Tweaker, Advanced, Power, Boot, Tools, and Exit) on the menu bar have their respective menu items.

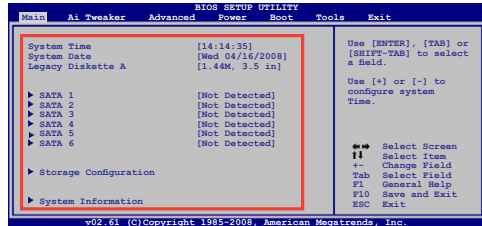

Main menu items

2.2.5 Submenu items

A solid triangle before each item on any menu screen means that the item has a sub-menu. To display the submenu, select the item and press **<Enter>**.

2.2.6 Configuration fields

These fields show the values for the menu items. If an item is user-configurable, you can change the value of the field opposite the item. You cannot select an item that is not user-configurable.

A configurable field is enclosed in brackets, and is highlighted when selected. To change the value of a field, select it then press **<Enter>** to display a list of options. Refer to **2.2.7 Pop-up window**.

2.2.7 Pop-up window

Select a menu item then press **<Enter>** to display a pop-up window with the configuration options for that item.

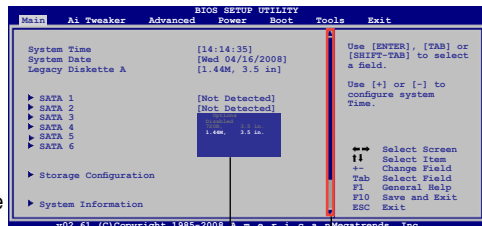

Pop-up window

Scroll bar

2.2.8 Scroll bar

A scroll bar appears on the right side of a menu screen when there are items that do not fit on the screen. Press the **<Up>** / **<Down>** arrow keys or **<Page Up>** / **<Page Down>** keys to display the other items on the screen.

2.2.9 General help

At the top right corner of the menu screen is a brief description of the selected item.

2.3 Main menu

When you enter the BIOS Setup program, the **Main** menu screen appears, giving you an overview of the basic system information.



Refer to section 2.2.1 **BIOS menu screen** for information on the menu screen items and how to navigate through them.

```
BIOS SETUP UTILITY
Main  Ai Tweaker  Advanced  Power  Boot  Tools  Exit

System Time           [14:14:35]
System Date           [Wed 04/16/2008]
Legacy Diskette A     [1.44M, 3.5 in]

▶ SATA 1               [Not Detected]
▶ SATA 2               [Not Detected]
▶ SATA 3               [Not Detected]
▶ SATA 4               [Not Detected]
▶ SATA 5               [Not Detected]
▶ SATA 6               [Not Detected]

▶ Storage Configuration

▶ System Information

Use [ENTER], [TAB] or [SHIFT-TAB] to select a field.

Use [+] or [-] to configure system time.

←→ Select Screen
↑↓ Select Item
+- Change Field
Tab Select Field
F1 General Help
F10 Save and Exit
ESC Exit

v02.61 (C)Copyright 1985-2008, American Megatrends, Inc.
```

2.3.1 System Time [xx:xx:xx]

Allows you to set the system time.

2.3.2 System Date [Day xx/xx/xxxx]

Allows you to set the system date.

2.3.3 Legacy Diskette A [1.44M, 3.5 in.]

Sets the type of floppy drive installed. Configuration options: [Disabled] [720K, 3.5 in.] [1.44M, 3.5 in.]

2.3.4 SATA 1-6

While entering Setup, the BIOS automatically detects the presence of Serial ATA (SATA) devices. There is a separate submenu for each SATA device. Select a device item then press **<Enter>** to display the SATA device information.

The BIOS automatically detects the values opposite the dimmed items (Device, Vendor, Size, LBA Mode, Block Mode, PIO Mode, Async DMA, Ultra DMA, and SMART Monitoring). These values are not user-configurable. These items show **N/A** if no SATA device is installed in the system.

Type [Auto]

Selects the type of IDE drive. Setting to **[Auto]** allows automatic selection of the appropriate IDE device type. Select **[CDROM]** if you are specifically configuring a CD-ROM drive. Select **[ARMD]** (ATAPI Removable Media Device) if your device is either a ZIP, LS-120, or MO drive. Configuration options: [Not Installed] [Auto] [CDROM] [ARMD]

LBA/Large Mode [Auto]

Enables or disables the LBA mode. Setting to **[Auto]** enables the LBA mode if the device supports this mode, and if the device was not previously formatted with LBA mode disabled. Configuration options: [Disabled] [Auto]

Block (Multi-sector Transfer) M [Auto]

Enables or disables data multi-sectors transfers. When set to **[Auto]**, the data transfer from and to the device occurs multiple sectors at a time if the device supports multi-sector transfer feature. When set to **[Disabled]**, the data transfer from and to the device occurs one sector at a time. Configuration options: [Disabled] [Auto]

PIO Mode [Auto]

Selects the PIO mode. Configuration options: [Auto] [0] [1] [2] [3] [4]

DMA Mode [Auto]

Selects the DMA mode. Configuration options: [Auto]

SMART Monitoring [Auto]

Sets the Smart Monitoring, Analysis, and Reporting Technology. Configuration options: [Auto] [Disabled] [Enabled]

32Bit Data Transfer [Enabled]

Enables or disables 32-bit data transfer. Configuration options: [Disabled] [Enabled]

2.3.5 Storage Configuration

The items in this menu allow you to set or change the configurations for the SATA devices installed in the system. Select an item then press **<Enter>** if you want to configure the item.

SATA Configuration [Enhanced]

Configuration options: [Disabled] [Compatible] [Enhanced]

Configure SATA as [IDE]

Sets the configuration for the Serial ATA connectors supported by the Southbridge chip. Configuration options: [IDE] [AHCI]



Due to Intel chipset driver support regulation, the AHCI mode is not supported in Windows XP environment. The AHCI mode is only supported by Windows Vista with OS built-in driver.

Hard Disk Write Protect [Disabled]

Disables or enables device write protection. This will be effective only if device is accessed through BIOS. Configuration option: [Disabled] [Enabled]

IDE Detect Time Out (Sec) [35]

Selects the time out value for detecting ATA/ATAPI devices.
Configuration options: [0] [5] [10] [15] [20] [25] [30] [35]

2.3.6 System Information

This menu gives you an overview of the general system specifications. The BIOS automatically detects the items in this menu.

Bios Information

Displays the auto-detected BIOS information.

Processor

Displays the auto-detected CPU specification.

System Memory

Displays the auto-detected system memory.

2.4 Ai Tweaker menu

The **Ai Tweaker** menu items allow you to configure system performance settings. Select an item then press **<Enter>** to display the configuration options.



Take caution when changing the settings of the Ai Tweaker menu items. Incorrect field values can cause the system to malfunction.

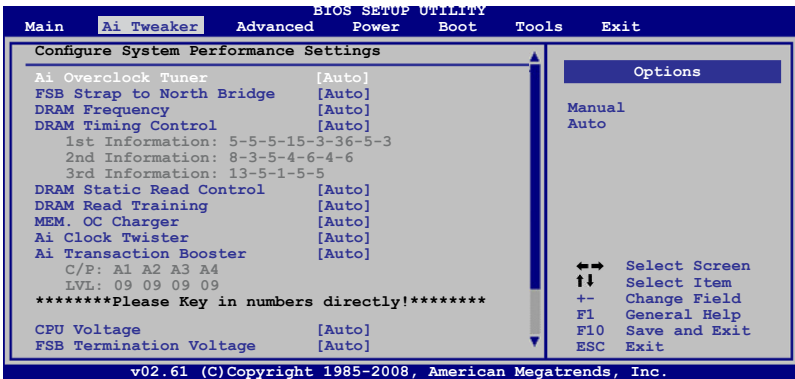

Scroll down to display the following items:

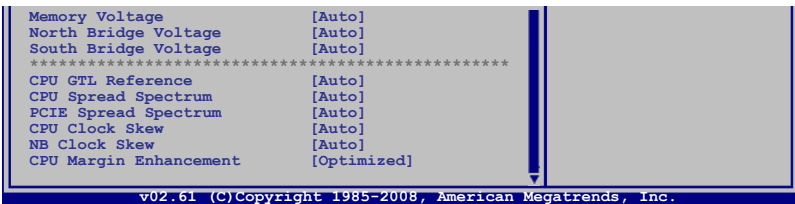

Ai Overclock Tuner [Auto]

Allows selection of CPU overclocking options to achieve desired CPU internal frequency. Select either one of the preset overclocking configuration options:

Manual - allows you to manually set overclocking parameters.

Auto - loads the optimal settings for the system.



The follow items appear only when you set the **[Ai Overclock Tuner]** item to **[Manual]**.

FSB Frequency [xxx]

Displays the frequency sent by the clock generator to the system bus and PCI bus. Use the <+> and <-> keys to adjust the FSB frequency. You can also type the desired FSB frequency using the numeric keypad. The values range from 200 to 600. Refer to the table below for the correct Front Side Bus and CPU External Frequency settings.

FSB / CPU External Frequency Synchronization

Front Side Bus	CPU External Frequency
FSB 1600	400 MHz
FSB 1333	333 MHz
FSB 1066	266 MHz
FSB 800	200 MHz
FSB 533	133 MHz

PCIE Frequency [Auto]

Use the <+> and <-> keys to adjust the PCIE frequency. You can also type the desired PCIE frequency using the numeric keypad. The values range from 100 to 160.

FSB Strap to North Bridge [Auto]

Allows you to adjust the FSB strap. Configuration options: [Auto] [200MHz] [266MHz] [333MHz] [400MHz]

DRAM Frequency [Auto]

Allows you to set the DDR2 operating frequency. Configuration options: [Auto] [DDR2-533MHz] [DDR2-639MHz] [DDR2-667MHz] [DDR2-709MHz] [DDR2-800MHz] [DDR2-852MHz] [DDR2-887MHz] [DDR2-1066MHz]



Setting a very high DRAM frequency may cause the system to become unstable. If this happens, revert to the default settings.

DRAM Timing Control [Auto]

Allows selection of the DRAM timing configuration. Configuration options: [Auto] [Manual]



- The following items appear only when you set the **[DRAM Timing Control]** item to **[Manual]**.
 - The configuration options for some of the following items vary depending on the DIMMs you install on the motherboard.
-

1st Information: 5-5-5-15-3-36-5-3

CAS# Latency [5 DRAM Clocks]

Configuration options: [3 DRAM Clocks] ~ [11 DRAM Clocks]

DRAM RAS# to CAS# Delay [5 DRAM Clocks]

Configuration options: [3 DRAM Clocks] ~ [18 DRAM Clocks]

DRAM RAS# Precharge [5 DRAM Clocks]

Configuration options: [3 DRAM Clocks] ~ [18 DRAM Clocks]

RAS# Activate to Precharge [15 DRAM Clocks]

Configuration options: [3 DRAM Clocks] ~ [34 DRAM Clocks]

RAS# to RAS# Delay [Auto]

Configuration options: [Auto] [1 DRAM Clocks] ~ [15 DRAM Clocks]

Row Refresh Cycle Time [Auto]

Configuration options: [Auto] [20 DRAM Clocks] [25 DRAM Clocks]
[30 DRAM Clocks] [35 DRAM Clocks] [40 DRAM Clocks] [45 DRAM Clocks] [50 DRAM
Clocks] [55 DRAM Clocks] [60 DRAM Clocks] [65 DRAM Clocks] [70 DRAM Clocks]
[80 DRAM Clocks] [85 DRAM Clocks] [105 DRAM Clocks] [132 DRAM Clocks]

Write Recovery Time [Auto]

Configuration options: [Auto] [1 DRAM Clocks] ~ [15 DRAM Clocks]

Read to Precharge Time [Auto]

Configuration options: [Auto] [1 DRAM Clocks] ~ [15 DRAM Clocks]

2nd Information: 8-3-5-4-6-4-6

READ to WRITE Delay (S/D) [Auto]

Configuration options: [Auto] [1 DRAM Clocks] ~ [15 DRAM Clocks]

WRITE to READ Delay (S) [Auto]

Configuration options: [Auto] [1 DRAM Clocks] ~ [15 DRAM Clocks]

WRITE to READ Delay (D) [Auto]

Configuration options: [Auto] [1 DRAM Clocks] ~ [15 DRAM Clocks]

READ to READ Delay (S) [Auto]

Configuration options: [Auto] [1 DRAM Clocks] ~ [15 DRAM Clocks]

READ to READ Delay (D) [Auto]

Configuration options: [Auto] [1 DRAM Clocks] ~ [15 DRAM Clocks]

WRITE to WRITE Delay (S) [Auto]

Configuration options: [Auto] [1 DRAM Clocks] ~ [15 DRAM Clocks]

WRITE to WRITE Delay (D) [Auto]

Configuration options: [Auto] [1 DRAM Clocks] ~ [15 DRAM Clocks]

3rd Information: 13-5-1-5-5

WRITE to PRE Delay [Auto]

Configuration options: [Auto] [1 DRAM Clocks] ~ [31 DRAM Clocks]

READ to PRE Delay [Auto]

Configuration options: [Auto] [1 DRAM Clocks] ~ [15 DRAM Clocks]

PRE to PRE Delay [Auto]

Configuration options: [Auto] [1 DRAM Clocks] ~ [3 DRAM Clocks]

ALL PRE to ACT Delay [Auto]

Configuration options: [Auto] [1 DRAM Clocks] ~ [15 DRAM Clocks]

ALL PRE to REF Delay [Auto]

Configuration options: [Auto] [1 DRAM Clocks] ~ [15 DRAM Clocks]

DRAM Static Read Control [Auto]

Adjusting this item might enhance DRAM overclocking ability.
Configuration options: [Auto] [Disabled] [Enabled]

DRAM Read Training [Auto]

Adjusting this item might enhance DRAM overclocking ability.
Configuration options: [Auto] [Disabled] [Enabled]

MEM. OC Charger [Auto]

Adjusting this item might enhance DRAM overclocking ability.
Configuration options: [Auto] [Disabled] [Enabled]

Ai Clock Twister [Auto]

Allows you to set the DRAM performance. Set this item to **[Light]** or **[Lighter]** to enhance DRAM compatibility, or **[Strong]** or **[Stronger]** to accelerate DRAM performance.
Configuration options: [Auto] [Lighter] [Light] [Moderate] [Strong] [Stronger]

Ai Transaction Booster [Auto]

Allows you to set the system performance. Configuration options: [Auto] [Manual]



The following items appear only when you set the **Ai Transaction Booster** item to **[Manual]**.

C/P: A1 A2 A3 A4

LVL: 09 09 09 09

Common Performance Level [05]

Set this item to a higher level for better compatibility or a lower level for better performance. Use the <+> and <-> keys to adjust the value.

Pull-In of CHA/B PH1/2/3/4 [Disabled]

Set this item to **[Enabled]** to apply enhancement on DRAM Channel A and B, Phase 1 to 4. The number of phases is determined by DRAM frequency and FSB strap.
Configuration options: [Disabled] [Enabled]

CPU Voltage [Auto]

Allows you to set the CPU VCore voltage. The values range from 0.8500V to 1.7500V with a 0.00625V interval. Configuration options: [Auto]



Refer to the CPU documentation before setting the CPU Vcore voltage. Setting a high VCore voltage may damage the CPU permanently, and setting a low VCore voltage may make the system unstable.

FSB Termination Voltage [Auto]

Allows you to set the front side bus termination voltage. The values range from 1.20V to 1.50V with a 0.10V interval.



The minimum value becomes 1.10V and the maximum value becomes 1.40V when a 45nm CPU is detected.

Memory Voltage [Auto]

Allows you to set the memory voltage manually or **Auto**. Use the <+> and <-> keys to adjust the value. The value ranges from 1.80V to 2.20V with a 0.10V interval.

North Bridge Voltage [Auto]

Allows you to set the NB voltage manually or **Auto**. Use the <+> and <-> keys to adjust the value. The value ranges from 1.10V to 1.40V with a 0.10V interval.



Setting a very high voltage may damage the component permanently, and setting a very low voltage may cause the system to become unstable.

South Bridge Voltage [Auto]

Allows you to set the SB voltage. The value ranges from 1.50V to 1.70V with a 0.20V interval.

CPU GTL Reference [Auto]

Allows you to set the CPU GTL voltage reference. Configuration options: [Auto] [0.667x] [0.65x] [0.63x] [0.615x]

CPU Spread Spectrum [Auto]

Allows you to set the CPU spread spectrum. Configuration options: [Auto] [Disabled]

PCIe Spread Spectrum [Auto]

Allows you to set the PCIe spread spectrum. Configuration options: [Auto] [Disabled]

CPU Clock Skew [Auto]

Allows you to set the CPU clock skew. Configuration options: [Auto] [Normal] [Delay 75ps] [Delay 150ps] [Delay 225ps] [Delay 300ps] [Delay 375ps] [Delay 450ps] [Delay 525ps] [Delay 600ps] [Delay 675ps] [Delay 750ps] [Delay 825ps] [Delay 900ps] [Delay 975ps] [Delay 1050ps] [Delay 1100ps]

NB Clock Skew [Auto]

Allows you to set the NB clock skew. Configuration options: [Auto] [Normal] [Delay 75ps] [Delay 150ps] [Delay 225ps] [Delay 300ps] [Delay 375ps] [Delay 450ps] [Delay 525ps] [Delay 600ps] [Delay 675ps] [Delay 750ps] [Delay 825ps] [Delay 900ps] [Delay 975ps] [Delay 1050ps] [Delay 1100ps]

CPU Margin Enhancement [Optimized]

Configuration options: [Optimized] [Compatible]

2.5 Advanced menu

The **Advanced** menu items allow you to change the settings for the CPU and other system devices.



Take caution when changing the settings of the Advanced menu items. Incorrect field values can cause the system to malfunction.

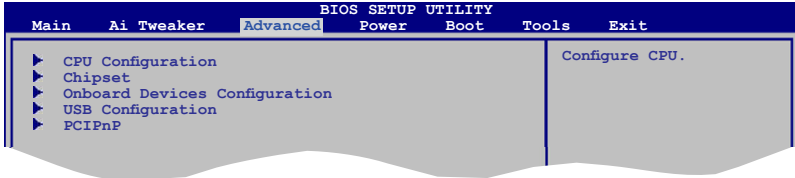

2.5.1 CPU Configuration

The items in this menu show the CPU-related information that the BIOS automatically detects.

CPU Ratio Setting [Auto]

Sets the ration between CPU core clock and the FSB frequency.



- If an invalid ratio is set in CMOS, then the actual and set values may differ.
- Key in ratio numbers directly.

C1E Support [Enabled]

Allows you to enable or disable C1E Support. Configuration options: [Disabled] [Enabled]

Max CPUID Value Limit [Disabled]

Setting this item to **[Enabled]** allows legacy operating systems to boot even without support for CPUs with extended CPUID functions. Configuration options: [Disabled] [Enabled]

Intel® Virtualization Technology [Enabled]

Enables or disables Intel® Virtualization Technology. Virtualization enhanced by Intel® Virtualization Technology allows a platform to run multiple operating systems and applications in independent partitons. With virtualization, one computer system can function as multiple virtual systems. Configuration options: [Enabled] [Disabled]

CPU TM function [Enabled]

Enables or disables Intel® CPU Thermal Monitor (TM) function, a CPU overheating protection function. When enabled, the CPU core frequency and voltage are reduced when the CPU overheats. Configuration options: [Disabled] [Enabled]

Execute-Disable Bit Capability [Enabled]

Allows you to enable or disable the No-Execution Page Protection Technology. Setting this item to **[Disabled]** forces the XD feature flag to always return to zero (0). Configuration options: [Disabled] [Enabled]



The following item appears only when you installed an Intel® Pentium® 4 or later CPU that supports the Enhanced Intel® SpeedStep® Technology (EIST).

Intel® SpeedStep® Technology [Enabled]

Allows you to use the Enhanced Intel® SpeedStep® Technology. When set to **[Enabled]**, you can adjust the system power settings in the operating system to use the EIST feature. Set this item to **[Disabled]** if you do not want to use the EIST.

Configuration options: [Enabled] [Disabled]

2.5.2 Chipset

The **Chipset** menu allows you to change the advanced chipset settings. Select an item then press **<Enter>** to display the sub-menu.

North Bridge Configuration

Memory Remap Feature [Enabled]

Allows you to enable or disable the remapping of the overlapped PCI memory above the total physical memory. Enable this option only when you install 64-bit operating system.

Configuration options: [Disabled] [Enabled]

Memory Hole [Disabled]

Allows you to configure the memory hole. Configuration options: [Disabled] [15MB-16MB]

Initiate Graphic Adapter [PEG/PCI]

Allows you to decide which graphics controller to use as the primary boot device.

Configuration options: [PCI/PEG] [PEG/PCI]

2.5.3 Onboard Devices Configuration

High Definition Audio [Enabled]

Allows you to enable or disable the High Definition Audio. The following item appears only when you enable this item. Configuration options: [Enabled] [Disabled]

Front Panel Type [HD Audio]

Allows you to set the front panel audio connector (AAFP) mode to legacy AC'97 or high-definition audio depending on the audio standard that the front panel audio module supports. Configuration options: [AC97] [HD Audio]

Marvell IDE controller [Enabled]

Allows you to disable or enable the onboard Marvell® IDE controller.

Configuration options: [Enabled] [Disabled]

Onboard PCIE GbE LAN [Enabled]

Configuration options: [Enabled] [Disabled]

LAN Option ROM [Disabled]

This item appears only when you enable the **Onboard PCIE GbE LAN** item.

Configuration options: [Disabled] [Enabled]

Serial Port1 Address [3F8/IRQ4]

Allows you to select the Serial Port1 base address.

Configuration options: [Disabled] [3F8/IRQ4] [2F8/IRQ3] [3E8/IRQ4] [2E8/IRQ3]

2.5.4 USB Configuration

The items in this menu allows you to change the USB-related features. Select an item then press **<Enter>** to display the configuration options.



The **USB Devices Enabled** item shows auto-detected values. If no USB device is detected, the item shows **None**.

USB Functions [Enabled]

Allows you to enable or disable the USB functions. Configuration options: [Disabled] [Enabled]

USB 2.0 Controller [Enabled]

Allows you to enable or disable the USB 2.0 controller.

Configuration options: [Enabled] [Disabled]

USB 2.0 Controller Mode [HiSpeed]

Allows you to set the USB 2.0 controller mode to HiSpeed (480 Mbps) or FullSpeed (12 Mbps). This item appears only when you enable the USB 2.0 Controller item.

Configuration options: [FullSpeed] [HiSpeed]

BIOS EHCI Hand-off [Enabled]

Allows you to enable support for operating systems without an EHCI hand-off feature.

Configuration options: [Disabled] [Enabled]

Legacy USB Support [Auto]

Allows you to enable or disable support for legacy USB devices. Setting to **[Auto]** allows the system to detect the presence of USB devices at startup. If detected, the USB controller legacy mode is enabled. If no USB device is detected, the legacy USB support is disabled.

Configuration options: [Disabled] [Enabled] [Auto]

2.5.5 PCI PnP

The **PCI PnP** menu items allow you to change the advanced settings for PCI/PnP devices.



Take caution when changing the settings of the PCI PnP menu items. Incorrect field values can cause the system to malfunction.

Plug And Play O/S [No]

When set to **[No]**, BIOS configures all the devices in the system. When set to **[Yes]** and if you install a Plug and Play operating system, the operating system configures the Plug and Play devices not required for boot. Configuration options: [No] [Yes]

2.6 Power menu

The **Power** menu items allow you to change the settings for the Advanced Power Management (APM). Select an item then press **<Enter>** to display the configuration options.

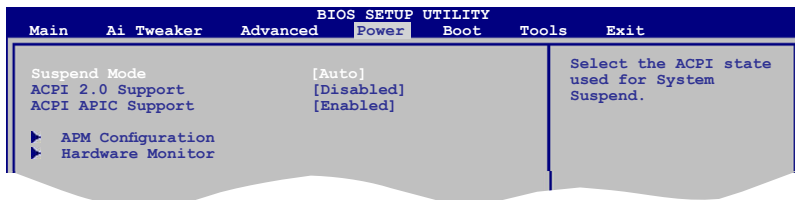

2.6.1 Suspend Mode [Auto]

Allows you to select the Advanced Configuration and Power Interface (ACPI) state to be used for system suspend. Configuration options: [S1 (POS) Only] [S3 Only] [Auto]

[S1(POS) Only] - Enables the system to enter the ACPI S1 (Power on Suspend) sleep state. In S1 sleep state, the system appears suspended and stays in a low power mode. The system can be resumed at any time.

[S3 Only] - Enables the system to enter the ACPI S3 (Suspend to RAM) sleep state (default). In S3 sleep state, the system appears to be off and consumes less power than in the S1 state. When signaled by a wake-up device or event, the system resumes to its working state exactly where it was left off.

[Auto] - Detected by OS.

2.6.2 ACPI 2.0 Support [Disabled]

Allows you to add more tables for Advanced Configuration and Power Interface (ACPI) 2.0 specifications. Configuration options: [Disabled] [Enabled]

2.6.3 ACPI APIC Support [Enabled]

Allows you to enable or disable the Advanced Configuration and Power Interface (ACPI) support in the Advanced Programmable Interrupt Controller (APIC). When set to **Enabled**, the ACPI APIC table pointer is included in the RSDT pointer list.

Configuration options: [Disabled] [Enabled]

2.6.4 APM Configuration

Restore On AC Power Loss [Power Off]

When set to **[Power Off]**, the system goes into off state after an AC power loss. When set to **[Power On]**, the system goes on after an AC power loss. When set to **[Last State]**, the system goes into either off or on state, whatever the system state was before the AC power loss. Configuration options: [Power Off] [Power On] [Last State]

Power On By RTC Alarm [Disabled]

Allows you to enable or disable RTC to generate a wake event. When this item is set to Enabled, the items RTC Alarm Date/ RTC Alarm Hour/ RTC Alarm Minute/ RTC Alarm Second will become user-configurable with set values.

Configuration options: [Disabled] [Enabled]

Power On By External Modems [Disabled]

This allows either settings of **[Enabled]** or **[Disabled]** for powering up the computer when the external modem receives a call while the computer is in Soft-off mode.

Configuration options: [Disabled] [Enabled]



The computer cannot receive or transmit data until the computer and applications are fully running. Thus, connection cannot be made on the first try. Turning an external modem off and then back on while the computer is off causes an initialization string that turns the system power on.

Power On By PCI Devices [Disabled]

Allows you to enable or disable the PME to wake up from S5 by PCI devices.

Configuration options: [Disabled] [Enabled]

Power On By PCIE Devices [Disabled]

Allows you to enable or disable the PCIE devices to generate a wake event.

Configuration options: [Disabled] [Enabled]

Power On By PS/2 Keyboard [Disabled]

Allows you to disable the Power On by PS/2 keyboard function or set specific keys on the PS/2 keyboard to turn on the system. This feature requires an ATX power supply that provides at least 1A on the +5VSB lead.

Configuration options: [Disabled] [Space Bar] [Ctrl-Esc] [Power Key]

Power On By PS/2 Mouse [Disabled]

When set to **[Enabled]**, this parameter allows you to use the PS/2 mouse to turn on the system. This feature requires an ATX power supply that provides at least 1A on the +5VSB lead. Configuration options: [Disabled] [Enabled]

2.6.5 Hardware Monitor

CPU Temperature [xxx°C/xxx°F]

MB Temperature [xxx°C/xxx°F]

The onboard hardware monitor automatically detects and displays the motherboard and CPU temperatures. Select **[Ignored]** if you do not wish to display the detected temperatures.

CPU Fan Speed [xxxxRPM] or [Ignored]

The onboard hardware monitor automatically detects and displays the CPU fan speed in rotations per minute (RPM). If the fan is not connected to the motherboard, the field shows **N/A**.

CPU Q-Fan Control [Disabled]

Allows you to enable or disable the CPU Q-Fan controller.

Configuration options: [Disabled] [Enabled]



The **CPU Fan Profile** item appears when you enable the CPU Q-Fan Control feature.

CPU Fan Profile [Standard]

Allows you to set the appropriate performance level of the CPU Q-Fan.

Configuration options: [Standard] [Silent] [Turbo]

Chassis Fan Speed [xxxxRPM] or [Ignored] / [N/A]

The onboard hardware monitor automatically detects and displays the chassis fan speed in rotations per minute (RPM). If the fan is not connected to the motherboard, the field shows **N/A**.

Power Fan Speed [xxxxRPM] or [Ignored] / [N/A]

The onboard hardware monitor automatically detects and displays the power fan speed in rotations per minute (RPM). If the fan is not connected to the motherboard, the field shows **N/A**.

CPU Voltage, 3.3V Voltage, 5V Voltage, 12V Voltage [xxxxV] or [Ignored]

The onboard hardware monitor automatically detects the voltage output through the onboard voltage regulators. Select **[Ignored]** if you do not want to detect this item.

2.7 Boot menu

The Boot menu items allow you to change the system boot options. Select an item then press **<Enter>** to display the sub-menu.

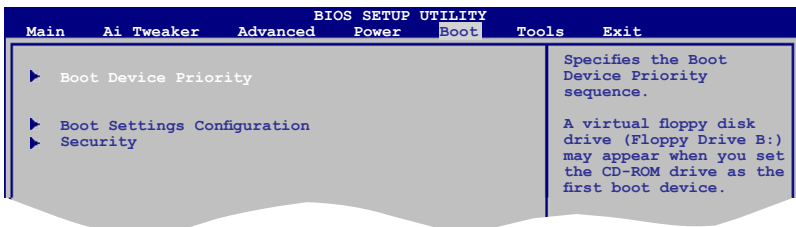

2.7.1 Boot Device Priority

1st ~ xxth Boot Device

These items specify the boot device priority sequence from the available devices. The number of device items that appears on the screen depends on the number of devices installed in the system. Configuration options: [1st FLOPPY DRIVE] [Hard Drive] [ATAPI CD-ROM] [Disabled]

2.7.2 Boot Settings Configuration

Quick Boot [Enabled]

Enabling this item allows the BIOS to skip some power on self tests (POST) while booting to decrease the time needed to boot the system. When set to **[Disabled]**, BIOS performs all the POST items. Configuration options: [Disabled] [Enabled]

Full Screen Logo [Enabled]

This allows you to enable or disable the full screen logo display feature. Configuration options: [Disabled] [Enabled]



Set this item to **[Enabled]** to use the ASUS MyLogo2™ feature.

AddOn ROM Display Mode [Force BIOS]

Sets the display mode for option ROM. Configuration options: [Force BIOS] [Keep Current]

Bootup Num-Lock [On]

Allows you to select the power-on state for the NumLock.

Configuration options: [Off] [On]

PS/2 Mouse Support [Auto]

Allows you to enable or disable support for PS/2 mouse.

Configuration options: [Disabled] [Enabled] [Auto]

Wait For 'F1' If Error [Enabled]

When set to **Enabled**, the system waits for the F1 key to be pressed when error occurs.

Configuration options: [Disabled] [Enabled]

Hit 'DEL' Message Display [Enabled]

When set to **[Enabled]**, the system displays the message **Press DEL to run Setup** during POST. Configuration options: [Disabled] [Enabled]

Interrupt 19 Capture [Disabled]

When set to **[Enabled]**, this function allows the option ROMs to trap Interrupt 19.

Configuration options: [Disabled] [Enabled]

2.7.3 Security

The **Security** menu items allow you to change the system security settings. Select an item then press **<Enter>** to display the configuration options.

Change Supervisor Password

Select this item to set or change the supervisor password. The **Supervisor Password** item on top of the screen shows the default **Not Installed**. After you set a password, this item shows **Installed**.

To set a Supervisor Password:

1. Select the **Change Supervisor Password** item then press **<Enter>**.
2. From the password box, type a password composed of at least six letters and/or numbers, then press **<Enter>**.
3. Confirm the password when prompted.

The message **Password Installed** appears after you successfully set your password.

To change the supervisor password, follow the same steps in setting a supervisor password.

To clear the supervisor password, select the **Change Supervisor Password** then press **<Enter>** twice. The message **Password uninstalled** appears.



If you forget your BIOS password, you can clear it by erasing the CMOS Real Time Clock (RTC) RAM. See section **1.9 Jumpers** for information on how to erase the RTC RAM.

After you have set a supervisor password, the other items appear to allow you to change other security settings.

User Access Level [Full Access]

This item allows you to select the access restriction to the Setup items.

Configuration options: [No Access] [View Only] [Limited] [Full Access]

[No Access] - prevents user access to the Setup utility.

[View Only] - allows access but does not allow change to any field.

[Limited] - allows changes only to selected fields, such as Date and Time.

[Full Access] - allows viewing and changing all the fields in the Setup utility.

Change User Password

Select this item to set or change the user password. The **User Password** item on top of the screen shows the default **Not Installed**. After you set a password, this item shows **Installed**.

To set a User Password:

1. Select the **Change User Password** item.
2. From the password box, type a password composed of at least six letters and/or numbers, then press **<Enter>**.
3. Confirm the password when prompted.

The message **Password Installed** appears after you set your password successfully.

To change the user password, follow the same steps in setting a user password.

Clear User Password

Select this item to clear the user password.

Password Check [Setup]

When set to **[Setup]**, BIOS checks for user password when accessing the Setup utility. When set to **[Always]**, BIOS checks for user password both when accessing Setup and booting the system. Configuration options: [Setup] [Always]

2.8 Tools menu

The **Tools** menu items allow you to configure options for special functions. Select an item then press **<Enter>** to display the submenu.

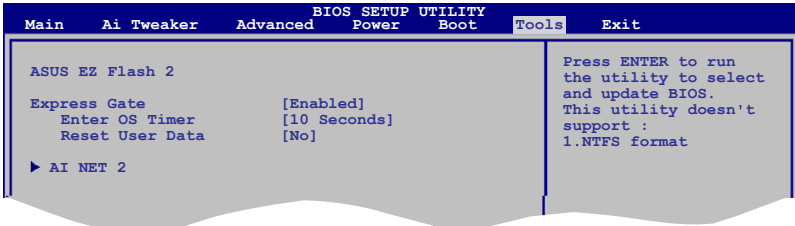

2.8.1 ASUS EZ Flash 2

Allows you to run ASUS EZ Flash 2. When you press **<Enter>**, a confirmation message appears. Use the left/right arrow key to select between **[Yes]** or **[No]**, then press **<Enter>** to confirm your choice.

2.8.2 Express Gate [Enabled]

Allows you to enable or disable the ASUS Express Gate feature. The ASUS Express Gate feature is a unique instant-on environment that provides quick access to the Internet browser and Skype. Configuration options: [Enabled] [Disabled]

Enter OS Timer [10 Seconds]

Sets countdown duration that the system waits at the Express Gate's first screen before starting Windows or other installed OS. Choose **[Prompt User]** to stay at the first screen of Express Gate for user action.

Configuration options: [Prompt User] [1 second] [3 seconds] [5 seconds] [10 seconds] [15 seconds] [20 seconds] [30 seconds]

Reset User Data [No]

Allows you to clear Express Gate's user data.

Configuration options: [No] [Reset]

When setting this item to **[Reset]**, ensure to save the setting to the BIOS so that the user data will be cleared the next time you enter the Express Gate. User data includes the Express Gate's settings as well as any personal information stored by the web browser (bookmarks, cookies, browsing history, etc.). This is useful in the rare case where corrupt settings prevent the Express Gate environment from launching properly.



The first time wizard will run again when you enter the Express Gate environment after clearing its settings.

2.8.3 AI NET 2

Check Realtek LAN cable [Disabled]

Enables or disables checking of the Realtek LAN cable during the Power-On Self-Test (POST). Configuration options: [Disabled] [Enabled]

2.9 Exit menu

The **Exit** menu items allow you to load the optimal or failsafe default values for the BIOS items, and save or discard your changes to the BIOS items.

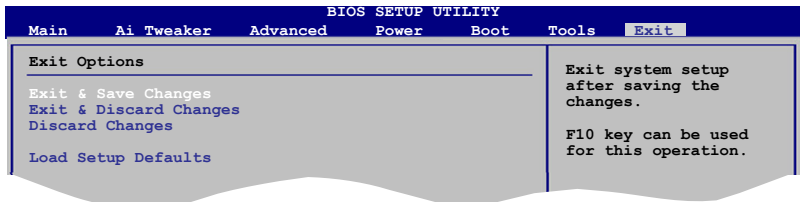

Pressing **<Esc>** does not immediately exit this menu. Select one of the options from this menu or **<F10>** from the legend bar to exit.

Exit & Save Changes

Once you are finished making your selections, choose this option from the Exit menu to ensure the values you selected are saved to the CMOS RAM. An onboard backup battery sustains the CMOS RAM so it stays on even when the PC is turned off. When you select this option, a confirmation window appears. Select **OK** to save changes and exit.

Exit & Discard Changes

Select this option only if you do not want to save the changes that you made to the Setup program. If you made changes to fields other than System Date, System Time, and Password, the BIOS asks for a confirmation before exiting.

Discard Changes

This option allows you to discard the selections you made and restore the previously saved values. After selecting this option, a confirmation appears. Select **OK** to discard any changes and load the previously saved values.

Load Setup Defaults

This option allows you to load the default values for each of the parameters on the Setup menu. When you select this option or if you press **<F5>**, a confirmation window appears. Select **OK** to load default values. Select **Exit & Save Changes** or make other changes before saving the values to the non-volatile RAM.

