

P5P43TD

Motherboard

ASUS®

E4782

First Edition V1

Jun 2009

Copyright © 2009 ASUSTeK Computer Inc. All Rights Reserved.

No part of this manual, including the products and software described in it, may be reproduced, transmitted, transcribed, stored in a retrieval system, or translated into any language in any form or by any means, except documentation kept by the purchaser for backup purposes, without the express written permission of ASUSTeK Computer Inc. ("ASUS").

Product warranty or service will not be extended if: (1) the product is repaired, modified or altered, unless such repair, modification or alteration is authorized in writing by ASUS; or (2) the serial number of the product is defaced or missing.

ASUS PROVIDES THIS MANUAL "AS IS" WITHOUT WARRANTY OF ANY KIND, EITHER EXPRESS OR IMPLIED, INCLUDING BUT NOT LIMITED TO THE IMPLIED WARRANTIES OR CONDITIONS OF MERCHANTABILITY OR FITNESS FOR A PARTICULAR PURPOSE. IN NO EVENT SHALL ASUS, ITS DIRECTORS, OFFICERS, EMPLOYEES OR AGENTS BE LIABLE FOR ANY INDIRECT, SPECIAL, INCIDENTAL, OR CONSEQUENTIAL DAMAGES (INCLUDING DAMAGES FOR LOSS OF PROFITS, LOSS OF BUSINESS, LOSS OF USE OR DATA, INTERRUPTION OF BUSINESS AND THE LIKE), EVEN IF ASUS HAS BEEN ADVISED OF THE POSSIBILITY OF SUCH DAMAGES ARISING FROM ANY DEFECT OR ERROR IN THIS MANUAL OR PRODUCT.

SPECIFICATIONS AND INFORMATION CONTAINED IN THIS MANUAL ARE FURNISHED FOR INFORMATIONAL USE ONLY, AND ARE SUBJECT TO CHANGE AT ANY TIME WITHOUT NOTICE, AND SHOULD NOT BE CONSTRUED AS A COMMITMENT BY ASUS. ASUS ASSUMES NO RESPONSIBILITY OR LIABILITY FOR ANY ERRORS OR INACCURACIES THAT MAY APPEAR IN THIS MANUAL, INCLUDING THE PRODUCTS AND SOFTWARE DESCRIBED IN IT.

Products and corporate names appearing in this manual may or may not be registered trademarks or copyrights of their respective companies, and are used only for identification or explanation and to the owners' benefit, without intent to infringe.

Contents

Notices.....	vi
Safety information	vii
About this guide	vii
P5P43TD specifications summary	ix
Chapter 1: Product introduction	
1.1 Welcome!	1-1
1.2 Package contents	1-1
1.3 Special features	1-1
1.3.1 Product highlights	1-1
1.3.2 Innovative ASUS features	1-2
1.4 Before you proceed	1-4
1.5 Motherboard overview	1-5
1.5.1 Placement direction	1-5
1.5.2 Screw holes	1-5
1.5.3 Motherboard layout	1-6
1.5.4 Layout contents.....	1-6
1.6 Central Processing Unit (CPU)	1-7
1.6.1 Installing the CPU	1-7
1.6.2 Installing the CPU heatsink and fan	1-10
1.6.3 Uninstalling the CPU heatsink and fan	1-11
1.7 System memory	1-12
1.7.1 Overview	1-12
1.7.2 Memory configurations.....	1-13
1.7.3 Installing a DIMM	1-17
1.7.4 Removing a DIMM	1-18
1.8 Expansion slots	1-19
1.8.1 Installing an expansion card	1-19
1.8.2 Configuring an expansion card	1-19
1.8.3 PCI slots.....	1-19
1.8.4 PCI Express x1 slots.....	1-19
1.8.5 PCI Express x16 slot.....	1-19
1.9 Jumpers	1-20

Contents

- 1.10 Connectors 1-21**
 - 1.10.1 Rear panel connectors 1-21
 - 1.10.2 Internal connectors 1-22
- 1.11 Software support..... 1-28**
 - 1.11.1 Installing an operating system 1-28
 - 1.11.2 Support DVD information 1-28
- Chapter 2: BIOS information**
- 2.1 Managing and updating your BIOS 2-1**
 - 2.1.1 ASUS Update utility 2-1
 - 2.1.2 ASUS EZ Flash 2 utility..... 2-2
 - 2.1.3 ASUS CrashFree BIOS 3 utility 2-3
- 2.2 BIOS setup program 2-4**
 - 2.2.1 BIOS menu screen..... 2-5
 - 2.2.2 Menu bar 2-5
 - 2.2.3 Navigation keys..... 2-6
 - 2.2.4 Menu items 2-6
 - 2.2.5 Submenu items 2-6
 - 2.2.6 Configuration fields 2-6
 - 2.2.7 Pop-up window 2-6
 - 2.2.8 Scroll bar..... 2-6
 - 2.2.9 General help 2-6
- 2.3 Main menu 2-7**
 - 2.3.1 System Time 2-7
 - 2.3.2 System Date 2-7
 - 2.3.3 SATA 1-6..... 2-7
 - 2.3.4 Storage Configuration 2-8
 - 2.3.5 System Information 2-9
- 2.4 Ai Tweaker menu 2-9**
- 2.5 Advanced menu 2-14**
 - 2.5.1 CPU Configuration 2-14
 - 2.5.2 Chipset..... 2-15
 - 2.5.3 Onboard Devices Configuration..... 2-15
 - 2.5.4 USB Configuration 2-16
 - 2.5.5 PCI PnP 2-17

Contents

2.6	Power menu	2-18
2.6.1	Suspend Mode.....	2-18
2.6.2	ACPI 2.0 Support.....	2-18
2.6.3	ACPI APIC Support.....	2-18
2.6.4	APM Configuration.....	2-18
2.6.5	Hardware Monitor	2-19
2.7	Boot menu	2-20
2.7.1	Boot Device Priority	2-20
2.7.2	Boot Settings Configuration	2-20
2.7.3	Security	2-21
2.8	Tools menu	2-23
2.8.1	ASUS EZ Flash 2.....	2-23
2.8.2	Express Gate	2-23
2.8.3	AI NET 2.....	2-23
2.9	Exit menu	2-24

Notices

Federal Communications Commission Statement

This device complies with Part 15 of the FCC Rules. Operation is subject to the following two conditions:

- This device may not cause harmful interference, and
- This device must accept any interference received including interference that may cause undesired operation.

This equipment has been tested and found to comply with the limits for a Class B digital device, pursuant to Part 15 of the FCC Rules. These limits are designed to provide reasonable protection against harmful interference in a residential installation. This equipment generates, uses and can radiate radio frequency energy and, if not installed and used in accordance with manufacturer's instructions, may cause harmful interference to radio communications. However, there is no guarantee that interference will not occur in a particular installation. If this equipment does cause harmful interference to radio or television reception, which can be determined by turning the equipment off and on, the user is encouraged to try to correct the interference by one or more of the following measures:

- Reorient or relocate the receiving antenna.
- Increase the separation between the equipment and receiver.
- Connect the equipment to an outlet on a circuit different from that to which the receiver is connected.
- Consult the dealer or an experienced radio/TV technician for help.



The use of shielded cables for connection of the monitor to the graphics card is required to assure compliance with FCC regulations. Changes or modifications to this unit not expressly approved by the party responsible for compliance could void the user's authority to operate this equipment.

Canadian Department of Communications Statement

This digital apparatus does not exceed the Class B limits for radio noise emissions from digital apparatus set out in the Radio Interference Regulations of the Canadian Department of Communications.

This class B digital apparatus complies with Canadian ICES-003.

REACH

Complying with the REACH (Registration, Evaluation, Authorisation, and Restriction of Chemicals) regulatory framework, we published the chemical substances in our products at ASUS REACH website at <http://green.asus.com/english/REACH.htm>.



DO NOT throw the motherboard in municipal waste. This product has been designed to enable proper reuse of parts and recycling. This symbol of the crossed out wheeled bin indicates that the product (electrical and electronic equipment) should not be placed in municipal waste. Check local regulations for disposal of electronic products.



DO NOT throw the mercury-containing button cell battery in municipal waste. This symbol of the crossed out wheeled bin indicates that the battery should not be placed in municipal waste.

Safety information

Electrical safety

- To prevent electrical shock hazard, disconnect the power cable from the electrical outlet before relocating the system.
- When adding or removing devices to or from the system, ensure that the power cables for the devices are unplugged before the signal cables are connected. If possible, disconnect all power cables from the existing system before you add a device.
- Before connecting or removing signal cables from the motherboard, ensure that all power cables are unplugged.
- Seek professional assistance before using an adapter or extension cord. These devices could interrupt the grounding circuit.
- Make sure that your power supply is set to the correct voltage in your area. If you are not sure about the voltage of the electrical outlet you are using, contact your local power company.
- If the power supply is broken, do not try to fix it by yourself. Contact a qualified service technician or your retailer.

Operation safety

- Before installing the motherboard and adding devices on it, carefully read all the manuals that came with the package.
- Before using the product, make sure all cables are correctly connected and the power cables are not damaged. If you detect any damage, contact your dealer immediately.
- To avoid short circuits, keep paper clips, screws, and staples away from connectors, slots, sockets and circuitry.
- Avoid dust, humidity, and temperature extremes. Do not place the product in any area where it may become wet.
- Place the product on a stable surface.
- If you encounter technical problems with the product, contact a qualified service technician or your retailer.

About this guide

This user guide contains the information you need when installing and configuring the motherboard.

How this guide is organized

This guide contains the following parts:

- **Chapter 1: Product introduction**
This chapter describes the features of the motherboard and the new technology it supports.
- **Chapter 2: BIOS information**
This chapter tells how to change system settings through the BIOS Setup menus. Detailed descriptions of the BIOS parameters are also provided.

Where to find more information

Refer to the following sources for additional information and for product and software updates.

1. ASUS websites

The ASUS website provides updated information on ASUS hardware and software products. Refer to the ASUS contact information.

2. Optional documentation

Your product package may include optional documentation, such as warranty flyers, that may have been added by your dealer. These documents are not part of the standard package.

Conventions used in this guide

To make sure that you perform certain tasks properly, take note of the following symbols used throughout this manual.



DANGER/WARNING: Information to prevent injury to yourself when trying to complete a task.



CAUTION: Information to prevent damage to the components when trying to complete a task.



IMPORTANT: Instructions that you **MUST** follow to complete a task.



NOTE: Tips and additional information to help you complete a task.

Typography

Bold text

Indicates a menu or an item to select.

Italics

Used to emphasize a word or a phrase.

<Key>

Keys enclosed in the less-than and greater-than sign means that you must press the enclosed key.

Example: <Enter> means that you must press the Enter or Return key.

<Key1>+<Key2>+<Key3>

If you must press two or more keys simultaneously, the key names are linked with a plus sign (+).

Example: <Ctrl>+<Alt>+<D>

P5P43TD specifications summary

CPU	LGA775 Socket for Intel® Core™2 Extreme / Core™2 Quad / Core™2 Duo / Pentium® dual-core / Celeron® dual-core processors Supports Intel® 45nm multi-core CPU Intel® Hyper-Threading Technology ready Support Enhanced Intel SpeedStep Technology (EIST) * Refer to www.asus.com for Intel® CPU support list.
Chipset	Northbridge: Intel® P43 Southbridge: Intel® ICH10
System bus	1600(O.C.)/1333/1066/800MHz
Memory	Dual-channel memory architecture <ul style="list-style-type: none"> - 4 x 240-pin DIMM sockets support unbuffered non-ECC DDR3 1600 (O.C.)/1333/1066/800MHz memory modules - Supports up to 16GB system memory <p>* We recommend that you install the memory modules on the orange slots for better overclocking capability.</p> <p>** Refer to www.asus.com or this user manual for the Memory QVL (Qualified Vendors Lists).</p> <p>*** When you install a total memory of 4GB capacity or more, Windows® 32-bit operating system may only recognize less than 3GB. We recommend a maximum of 3GB system memory if you are using a Windows® 32-bit operating system.</p>
Expansion slots	1 x PCI Express x16 slot 2 x PCI Express x1 slots 3 x PCI slots
Storage	Southbridge Intel® ICH10 supports: <ul style="list-style-type: none"> - 6 x Serial ATA 3Gb/s connectors JMB368 supports: <ul style="list-style-type: none"> - 1 x UltraDMA 133/100/66 connector
LAN	Atheros L1E Gb LAN controller
Audio	ALC887 High Definition Audio 8-channel CODEC <ul style="list-style-type: none"> - Supports Jack-detect and Multi-streaming technologies - Supports optical S/PDIF output interface
USB	12 x USB 2.0/1.1 ports (6 ports at mid-board, 6 ports at back panel)
ASUS exclusive overclocking features	SFS (Stepless Frequency Selection): <ul style="list-style-type: none"> - FSB tuning from 200MHz to 800MHz at 1MHz increment Overclocking protection: <ul style="list-style-type: none"> - ASUS C.P.R. (CPU Parameter Recall)

(continued on the next page)

P5P43TD specifications summary

ASUS Special features	ASUS CrashFree BIOS 3 ASUS EZ Flash 2 ASUS EPU-4 Engine ASUS Q-Fan ASUS Turbo Key ASUS AI NET 2 ASUS MyLogo 2 ASUS Express Gate
Rear panel ports	1 x PS/2 Keyboard / Mouse Combo port 1 x COM port 1 x LPT port 1 x Optical S/PDIF out port 1 x LAN (RJ-45) port 6 x USB 2.0/1.1 ports 8-channel audio I/O ports
Internal connectors	3 x USB 2.0/1.1 connectors support additional 6 USB 2.0/1.1 ports 1 x High Definition analog front panel audio connector 6 x SATA connectors 1 x S/PDIF output connector 1 x System panel connector 1 x CPU fan connector 1 x Chassis fan connector 1 x CD audio-in connector 1 x IDE connector 1 x 24-pin EATX Power connector 1 x 4-pin ATX 12V Power connector
BIOS features	8 Mb Flash ROM, AMI BIOS, Special Hardware Write Protection, PnP, DMI v2.0, WfM2.0, SMBIOS v2.5, ACPI v2 0a
Manageability	WOL by PME, WOR by PME, WOR by Ring
Accessories	1 x UltraDMA 133/100/66 cable 2 x Serial ATA cables 1 x I/O shield User Manual
Support DVD	Drivers ASUS Update ASUS PC Probe II Anti-virus software (OEM version)
Form factor	ATX form factor: 12 in x 8.8 in (30.5 cm x 22.4 cm)

* Specifications are subject to change without notice.

Chapter 1

Product introduction

1.1 Welcome!

Thank you for buying an ASUS® P5P43TD motherboard!

The motherboard delivers a host of new features and latest technologies, making it another standout in the long line of ASUS quality motherboards!

Before you start installing the motherboard, and hardware devices on it, check the items in your package with the list below.

1.2 Package contents

Check your motherboard package for the following items.

Motherboard	ASUS P5P43TD motherboard
Cables	2 x Serial ATA cables 1 x Ultra DMA 133/100/66 cable
Accessories	1 x I/O shield
Application DVD	ASUS motherboard support DVD
Documentation	User Manual



If any of the above items is damaged or missing, contact your retailer.

1.3 Special features

1.3.1 Product highlights



Intel® Core™2 Extreme / Core™2 Quad / Core™2 Duo CPU support

This motherboard supports Intel® LGA775 Core™ 2 Extreme / Core™ 2 Quad / Core™ 2 Duo processors, which are excellent for multitasking, multimedia, and enthusiastic gamers with 1600 (O. C.)/1333/1066/800 MHz FSB. This motherboard also supports Intel® CPUs in the 45nm manufacturing process.



Dual channel DDR3 1600 (O.C.)/1333/1066/800 support

This motherboard supports DDR3 memory that features data transfer rates of 1600 (O.C.)/1333/1066/800 MHz providing great performance for 3D graphics and other memory-demanding applications.



PCI Express architecture

PCI Express is the latest I/O interconnect technology that replaces the existing PCI. With a bus bandwidth two times higher than that of AGP 8X interface, PCI Express x16 bus performs much better in applications such as 3D gaming.



Serial ATA 3Gb/s technology

This motherboard supports hard drives based on the Serial ATA (SATA) 3Gb/s storage specifications, delivering enhanced salability and doubling the bus bandwidth for high-speed data saving and retrieval.



S/PDIF digital sound ready

This motherboard provides convenient connectivity to external home theater audio systems via the S/PDIF-out (SONY-PHILIPS Digital Interface) jack. It allows digital audio transfer and keeps the best signal quality.



Gigabit LAN solution

The onboard LAN controller is a highly integrated Gb LAN controller. It is enhanced with an ACPI management function to provide efficient power management for advanced operating systems.

1.3.2 Innovative ASUS features



ASUS MyLogo2™

This feature allows you to convert your favorite photo into a 256-color boot logo for a more colorful and vivid image on your screen.



ASUS CrashFree BIOS 3

ASUS CrashFree BIOS 3 is an auto-recovery tool that allows you to restore a corrupted BIOS file using the bundled support DVD or USB flash disk that contains the latest BIOS file.



ASUS Q-FAN

ASUS Q-FAN technology intelligently and automatically adjusts CPU fan speed according to system load and temperature, enabling users to work in distraction-free environment with minimal noise.



ASUS EZ Flash 2

ASUS EZ Flash 2 is a utility that allows you to update the BIOS without using an OS-based utility.



ASUS EPU

The ASUS EPU (Energy Processing Unit) provides total system power management by detecting current PC loading and intelligently moderating power in real-time. It automatically provides the most appropriate power usage to save power and money!



Express Gate

Express Gate is a unique OS built into the motherboard. Five seconds after bootup, you can instantly surf the Internet without entering the Windows® OS.



- For the SSD version, Express Gate is built into the motherboard, so you can access the Internet without entering the Windows® OS.
- Express Gate complies with the OpenGL standard. Refer to <http://support.asus.com> for Express Gate source codes.



ASUS AI NET2

ASUS AI NET2 remotely detects the cable connection immediately after turning on the system, and any faulty cable connections are reported back up to 100 meters at 1 meter accuracy.



Turbo Key

ASUS Turbo Key allows you to turn the PC power button into a physical overclocking button. After the easy setup, Turbo Key can boost performances without interrupting ongoing work or games—with just one touch!



C.P.R. (CPU Parameter Recall)

The BIOS C.P.R. feature automatically restores the CPU default settings when the system hangs due to overclocking failure. C.P.R. eliminates the need to open the system chassis and clear the RTC data. Simply shut down and reboot the system, and the BIOS automatically restores the CPU parameters to their default settings.



Green ASUS

This motherboard and its packaging comply with the European Union's Restriction on the use of Hazardous Substances (RoHS). This is in line with the ASUS vision of creating environment-friendly and recyclable products/packaging to safeguard consumers' health while minimizing the impact on the environment.

1.4 Before you proceed

Take note of the following precautions before you install motherboard components or change any motherboard settings.



- Unplug the power cord from the wall socket before touching any component.
- Before handling components, use a grounded wrist strap or touch a safely grounded object or a metal object, such as the power supply case, to avoid damaging them due to static electricity.
- Hold components by the edges to avoid touching the ICs on them.
- Whenever you uninstall any component, place it on a grounded antistatic pad or in the bag that came with the component.
- Before you install or remove any component, ensure that the ATX power supply is switched off or the power cord is detached from the power supply. Failure to do so may cause severe damage to the motherboard, peripherals, or components.

Onboard LED

The motherboard comes with a standby power LED that lights up to indicate that the system is ON, in sleep mode, or in soft-off mode. This is a reminder that you must shut down the system and unplug the power cable before removing or plugging in any motherboard component. The illustration below shows the location of the onboard LED.

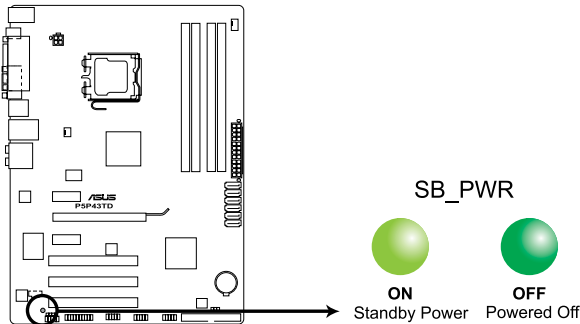

P5P43TD Onboard LED

1.5 Motherboard overview

Before you install the motherboard, study the configuration of your chassis to ensure that the motherboard fits into it.



Ensure that you unplug the power cord before installing or removing the motherboard. Failure to do so can cause you physical injury and damage motherboard components.

1.5.1 Placement direction

When installing the motherboard, ensure that you place it into the chassis in the correct orientation. The edge with external ports goes to the rear part of the chassis as indicated in the image below.

1.5.2 Screw holes

Place six screws into the holes indicated by circles to secure the motherboard to the chassis.



Do not overtighten the screws! Doing so can damage the motherboard.

Place this side towards
the rear of the chassis

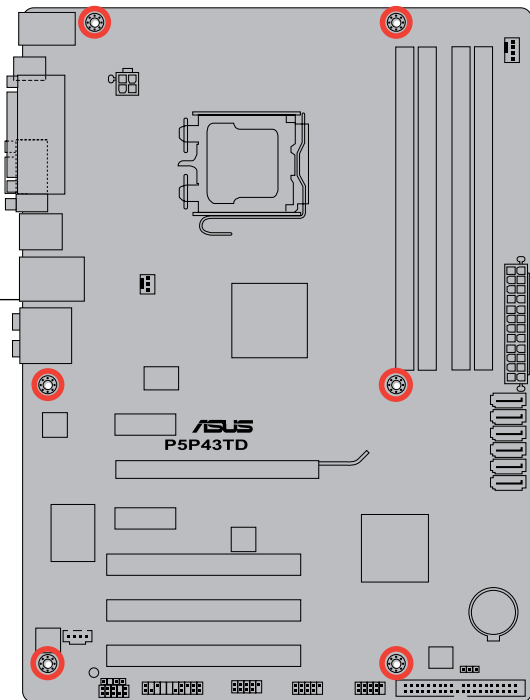

1.5.3 Motherboard layout

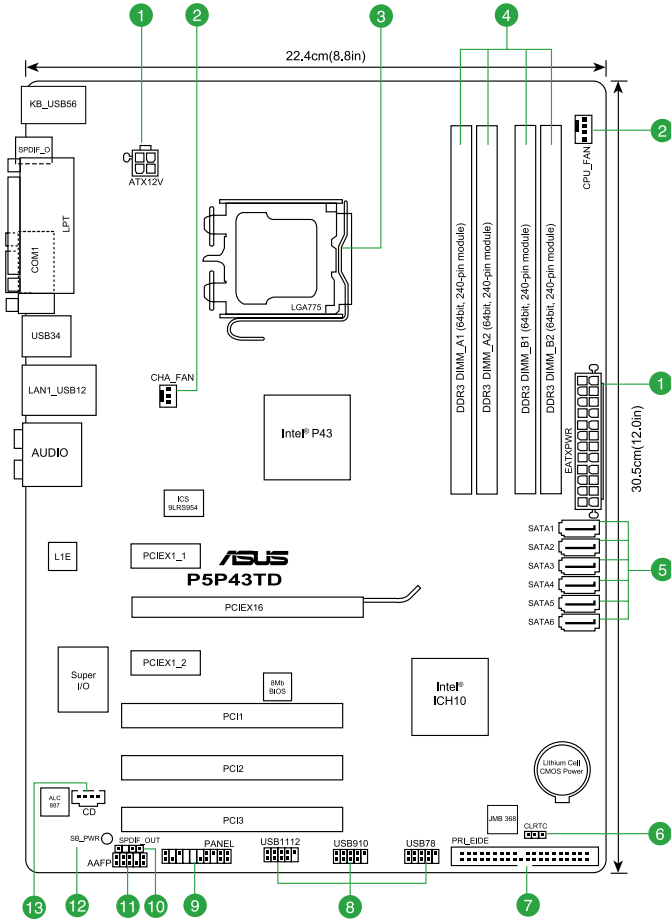

1.5.4 Layout contents

Connectors/Jumpers/Slots/LED	Page	Connectors/Jumpers/Slots/LED	Page
1. ATX power connectors (24-pin EATXPWR, 4-pin ATX12V)	1-23	8. USB connectors (10-1 pin USB78, USB910, USB1112)	1-27
2. CPU and chassis fan connectors (4-pin CPU_FAN, 3-pin CHA_FAN1)	1-22	9. System panel connector (20-8 pin PANEL)	1-26
3. LGA775 CPU socket	1-7	10. Digital audio connector (4-1 pin SPDIF_OUT)	1-23
4. DDR3 DIMM slots	1-12	11. Front panel audio connector (10-1 pin AAFP)	1-27
5. Serial ATA connectors (7-pin SATA1-6)	1-24	12. Onboard LED (SB_PWR)	1-4
6. Clear RTC RAM (3-pin CLRTC)	1-20	13. Optical drive audio connector (4-pin CD)	1-24
7. IDE connector (40-1 pin PRI_EIDE)	1-25		

1.6 Central Processing Unit (CPU)

The motherboard comes with a surface mount LGA775 socket designed for the Intel® Core™2 Extreme / Core™2 Quad / Core™2 Duo / Pentium® dual-core / Celeron® dual-core processors.



- Unplug all power cables before installing the CPU.
- Connect the chassis fan cable to the CHA_FAN connector to ensure system stability.



- Upon purchase of the motherboard, ensure that the PnP cap is on the socket and the socket contacts are not bent. Contact your retailer immediately if the PnP cap is missing, or if you see any damage to the PnP cap/socket contacts/motherboard components. ASUS will shoulder the cost of repair only if the damage is shipment/transit-related.
- Keep the cap after installing the motherboard. ASUS will process Return Merchandise Authorization (RMA) requests only if the motherboard comes with the cap on the LGA775 socket.
- The product warranty does not cover damage to the socket contacts resulting from incorrect CPU installation/removal, or misplacement/loss/incorrect removal of the PnP cap.



The motherboard supports Intel® LGA775 processors with the Intel® Enhanced Intel SpeedStep® Technology (EIST) and Hyper-Threading Technology.

1.6.1 Installing the CPU

To install a CPU:

1. Locate the CPU socket on the motherboard.

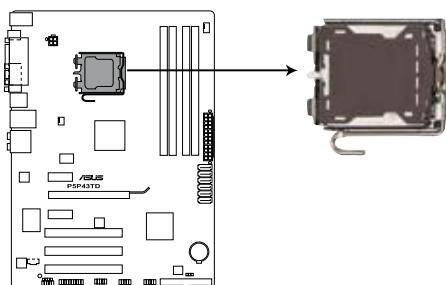

P5P43TD CPU socket 775



Before installing the CPU, ensure that the cam box is facing towards you and the load lever is on your left.

2. Press the load lever with your thumb (A), then move it to the left (B) until it is released from the retention tab.



To prevent damage to the socket pins, do not remove the PnP cap unless you are installing a CPU.

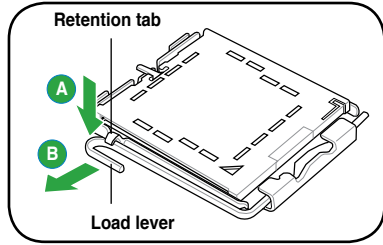

3. Lift the load lever in the direction of the arrow to a 135° angle.
4. Lift the load plate with your thumb and forefinger to a 100° angle (4A), then push the PnP cap from the load plate window to remove (4B).

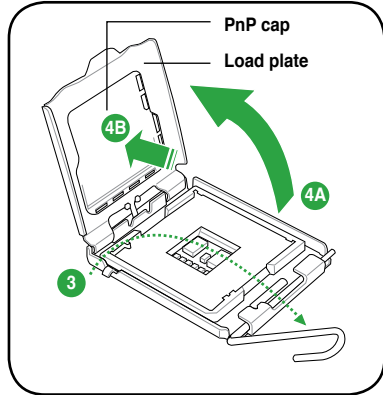

5. Position the CPU over the socket, ensuring that the gold triangle is on the bottom-left corner of the socket then fit the socket alignment key into the CPU notch.

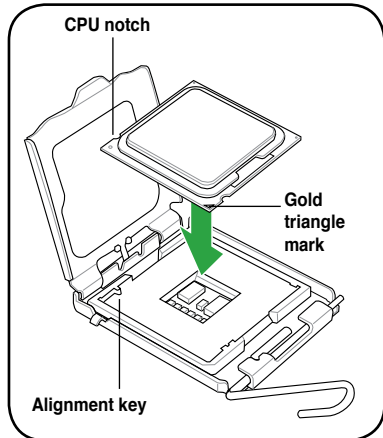

6. Apply some Thermal Interface Material to the exposed area of the CPU that the heatsink will be in contact with, ensuring that it is spread in an even thin layer.



Some heatsinks come with pre-applied thermal paste. If so, skip this step.

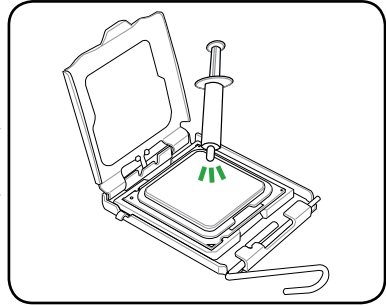

DO NOT eat the Thermal Interface Material. If it gets into your eyes or touches your skin, ensure that you wash it off immediately, and seek professional medical help.



To prevent contaminating the paste, **DO NOT** spread the paste with your finger directly.

7. Close the load plate (A), then push the load lever (B) until it snaps into the retention tab.

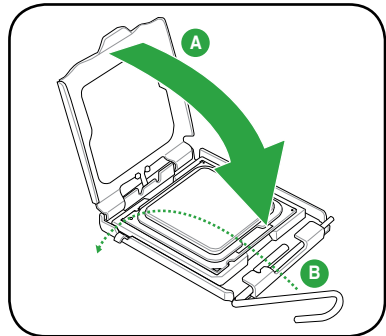

1.6.2 Installing the CPU heatsink and fan

The Intel® LGA775 processor requires a specially designed heatsink and fan assembly to ensure optimum thermal condition and performance.



- When you buy a boxed Intel® processor, the package includes the CPU fan and heatsink assembly. If you buy a CPU separately, ensure that you use only Intel®-certified multi-directional heatsink and fan.
- Your Intel® LGA775 heatsink and fan assembly comes in a push-pin design and requires no tool to install.
- If you purchased a separate CPU heatsink and fan assembly, ensure that you have properly applied Thermal Interface Material to the CPU heatsink or CPU before you install the heatsink and fan assembly.



Ensure that you have installed the motherboard to the chassis before you install the CPU fan and heatsink assembly.

To install the CPU heatsink and fan:

1. Place the heatsink on top of the installed CPU, ensuring that the four fasteners match the holes on the motherboard.



Orient the heatsink and fan assembly such that the CPU fan cable is closest to the CPU fan connector.

2. Push down two fasteners at a time in a diagonal sequence to secure the heatsink and fan assembly in place.

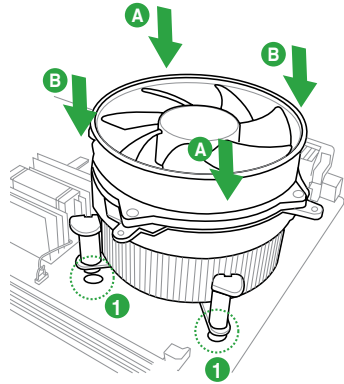
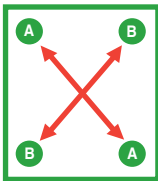

The type of CPU heatsink and fan assembly may differ, but the installation steps and functions should remain the same. The illustration above is for reference only.

3. Connect the CPU fan cable to the connector on the motherboard labeled CPU_FAN.

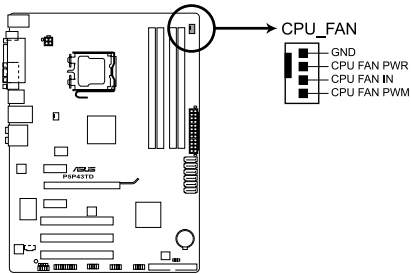

P5P43TD CPU fan connector



Do not forget to connect the CPU fan connector! Hardware monitoring errors can occur if you fail to plug this connector.

1.6.3 Uninstalling the CPU heatsink and fan

To uninstall the CPU heatsink and fan:

1. Disconnect the CPU fan cable from the connector on the motherboard.
2. Rotate each fastener counterclockwise.
3. Pull up two fasteners at a time in a diagonal sequence to disengage the heatsink and fan assembly from the motherboard.

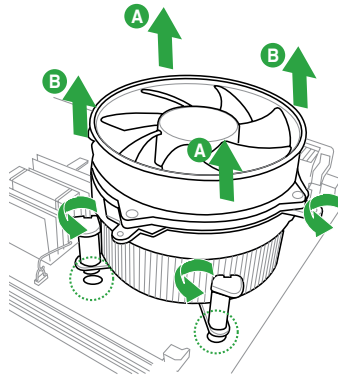
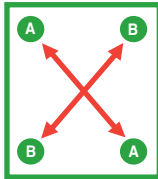

4. Carefully remove the heatsink and fan assembly from the motherboard.
5. Rotate each fastener clockwise to ensure correct orientation when reinstalling.

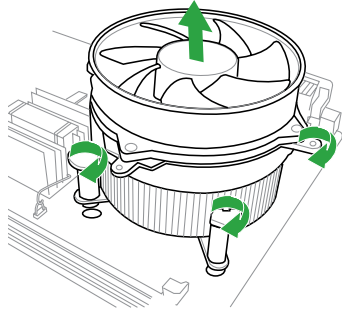

1.7 System memory

1.7.1 Overview

The motherboard comes with four Double Data Rate 3 (DDR3) Dual Inline Memory Modules (DIMM) sockets. The figure illustrates the location of the DDR3 DIMM sockets:

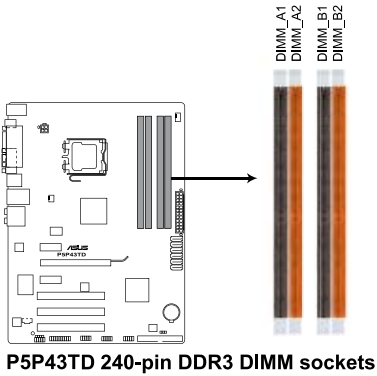

Channel	Sockets
Channel A	DIMM_A1 and DIMM_A2
Channel B	DIMM_B1 and DIMM_B2

1.7.2 Memory configurations

You may install 512MB, 1GB, 2GB, and 4GB unbuffered non-ECC DDR3 DIMMs into the DIMM sockets.



-
- You may install varying memory sizes in Channel A and Channel B. The system maps the total size of the lower-sized channel for the dual-channel configuration. Any excess memory from the higher-sized channel is then mapped for single-channel operation.
 - For dual-channel configuration, you can:
 - install two identical DIMMs in DIMM_A1 and DIMM_B1; or
 - install four identical DIMMs in all four slots; or
 - install one identical DIMM pair in DIMM_A1 and DIMM_B1 (black slots) and another identical DIMM pair in DIMM_A2 and DIMM_B2 (orange slots).
 - Always install DIMMs with the same CAS latency. For optimum compatibility, it is recommended that you obtain memory modules from the same vendor.
 - Due to the memory address limitation on 32-bit Windows® OS, when you install 4GB or more memory on the motherboard, the actual usable memory for the OS can be about 3GB or less. For effective use of memory, we recommend that you do any of the following:
 - Use a maximum of 3GB system memory if you are using a 32-bit Windows® OS.
 - Install a 64-bit Windows® OS when you want to install 4GB or more memory on the motherboard.
 - This motherboard does not support DIMMs made up of 256 megabits (Mb) chips or less.
-



-
- This motherboard supports up to 16GB on Windows® XP Professional x64 and Windows® Vista x64 editions. You may install a maximum of 4GB DIMMs on each slot.
 - The default memory operation frequency is dependent on its Serial Presence Detect (SPD), which is the standard way of accessing information from a memory module. Under the default state, some memory modules for overclocking may operate at a lower frequency than the vendor-marked value.
 - For system stability, use a more efficient cooling system to support a full memory load (4 DIMMs) or overclocking conditions.
-

P5P43TD Motherboard Qualified Vendors Lists (QVL)

DDR3-1600 (O.C.) MHz capability

Vendor	Part No.	Size	SS/ DD	Chip Brand	Chip No.	CL	DIMM Support		
							A*	B*	C*
A-DATA	AD31600E001GMU	3072MB(Kit of 3)	SS	N/A	Heat-Sink Package	8-8-8-24(1333-9-9-9-24)	.		
A-DATA	AD31600F002GMU(XMP)	6144MB(Kit of 3)	DS	N/A	Heat-Sink Package	7-7-7-20(1333-9-9-9-24)	.	.	
CORSAIR	TR3X3G1600C8D(XMP)Ver2.1	3072MB(Kit of 3)	SS	N/A	Heat-Sink Package	8-8-8-24(1601-8-8-8-24)	.	.	
CORSAIR	TR3X3G1600C8D	3072MB(Kit of 3)	SS	N/A	Heat-Sink Package	8-8-8-24(1600-8-8-8-24)	.	.	
CORSAIR	TR3X3G1600C9(XMP)Ver1.1	3072MB(Kit of 3)	SS	N/A	Heat-Sink Package	9-9-9-24(1601-9-9-9-24)	.	.	
CORSAIR	BoxP/N:TW3X4G1600C9DHXNV (CM3X2G1600C9DHXNV)Ver4.1	4096MB(Kit of 2)	DS	N/A	Heat-Sink Package	(1333-9-9-9-24)	.		
CORSAIR	TR3X6G1600C8D(XMP)Ver2.1	6144MB(Kit of 3)	DS	N/A	Heat-Sink Package	8-8-8-24(1601-8-8-8-24)	.	.	
CORSAIR	TR3X6G1600C8D	6144MB(Kit of 3)	DS	N/A	Heat-Sink Package	8-8-8-24(1600-8-8-8-24)	.	.	
CORSAIR	TR3X6G1600C9(XMP)Ver2.1	6144MB(Kit of 3)	DS	N/A	Heat-Sink Package	9-9-9-24(1333-9-9-9-24)	.	.	
Crucial	BL12864BA1608.8SFB(XMP)	1024MB	SS	N/A	Heat-Sink Package	(1601-8-8-8-24)	.	.	
G.SKILL	F3-12800CL7D-2GBHZ	2048MB(Kit of 2)	SS	N/A	Heat-Sink Package	(1601-7-7-7-18)	.	.	
G.SKILL	F3-12800CL9D-2GBNQ	2048MB(Kit of 2)	SS	N/A	Heat-Sink Package	(1333-9-9-9-24)	.	.	
G.SKILL	F3-12800CL7D-4GBPI	4096MB(Kit of 2)	DS	N/A	Heat-Sink Package	7-7-7-18(1333-9-9-9-24)	.		
G.Skill	F3-12800CL8T-6GBHK(XMP)	6144MB(Kit of 3)	DS	N/A	Heat-Sink Package	8-8-8-21(1333-8-8-8-21)	.		
G.SKILL	F3-12800CL9T-6GBNQ	6144MB(Kit of 3)	DS	N/A	Heat-Sink Package	9-9-9-24(1601-9-9-9-24)	.	.	.
GEIL	GV34GB1600C8DC	4096MB(Kit of 2)	DS	N/A	Heat-Sink Package	8-8-8-28(1600-8-8-8-28)	.	.	
KINGMAX	FLGD45F-B8KG9-NAES	1024MB	SS	KINGMAX	KFB8FNGXF-ANX-12A	9(1600-9-8-9-28)	.	.	
KINGMAX	FLGEG85F-B8KG9-NEES	2048MB	DS	KINGMAX	KFB8FNGXF-ANX-12A	9(1600-9-8-9-28)	.	.	.
KINGSTON	KHX12800D3LLK3/3GX(XMP)	3072MB(Kit of 3)	SS	N/A	Heat-Sink Package	1600-8-8-8-20	.	.	
KINGSTON	KHX12800D3K2/4G	4096MB(Kit of 2)	DS	N/A	Heat-Sink Package	9(1333-9-9-9-24)	.	.	
OCZ	OCZ3G1600LV3GK	3072MB(Kit of 3)	SS	N/A	Heat-Sink Package	8-8-8(1066-7-7-7-20)	.	.	
OCZ	OCZ3P1600LV3GK	3072MB(Kit of 3)	SS	N/A	Heat-Sink Package	7-7-7(1066-7-7-7-20)	.	.	.
OCZ	OCZ3P16004GK	4096MB(Kit of 2)	DS	N/A	Heat-Sink Package	7-7-7(1333-7-7-7-20)	.		
OCZ	OCZ3P1600EB4GK	4096MB(Kit of 2)	DS	N/A	Heat-Sink Package	7-7-6(1333-7-7-7-20)	.		
OCZ	OCZ3X16004GK	4096MB(Kit of 2)	DS	N/A	Heat-Sink Package	7-7-7-20	.	.	
OCZ	OCZ3G1600LV6GK	6144MB(Kit of 3)	DS	N/A	Heat-Sink Package	8-8-8(1066-7-7-7-20)	.	.	
OCZ	OCZ3X1600LV6GK(XMP)	6144MB(Kit of 3)	DS	N/A	Heat-Sink Package	8-8-8(1600-8-8-8-24)	.		
Super Talent	WA160UX6G9	6144MB(Kit of 3)	DS	N/A	Heat-Sink Package	9(1333-9-9-9-28)	.	.	
Cell Shock	CS322271	2048MB(Kit of 2)	DS	N/A	Heat-Sink Package	7-7-7-14(1066-7-7-7-20)	.	.	
Elixir	M2F2G64CB8HA4N-DG	2048MB	DS	Elixir	N2CB1G80AN-DG	9(1333-9-9-9-28)	.	.	.
Mushkin	996657	4096MB(Kit of 2)	DS	N/A	Heat-Sink Package	7-7-7-20	.		
Mushkin	998659	6144MB(Kit of 3)	DS	N/A	Heat-Sink Package	9-9-9-24(1333-9-9-9-24)	.	.	
Patriot	PVT33G1600ELK	3072MB(Kit of 3)	SS	N/A	Heat-Sink Package	9-9-9-24(1066-7-7-7-20)	.	.	
Patriot	PVS34G1600ELK	4096MB(Kit of 2)	DS	N/A	Heat-Sink Package	9-9-9-24(1066-7-7-7-20)	.		
Patriot	PVS34G1600LLK	4096MB(Kit of 2)	DS	N/A	Heat-Sink Package	7-7-7-20(1066-7-7-7-20)	.	.	
Patriot	PVS34G1600LLKN	4096MB(Kit of 2)	DS	N/A	Heat-Sink Package	7-7-7-20(1066-7-7-7-20)	.	.	
Patriot	PVT36G1600ELK	6144MB(Kit of 3)	DS	N/A	Heat-Sink Package	9-9-9-24(1066-7-7-7-20)	.	.	.
Patriot	PVT36G1600ELK	6144MB(Kit of 3)	DS	N/A	Heat-Sink Package	9-9-9-24(1600-7-7-7-20)	.	.	.
PQI	MFADR401PA0102(XMP)	2048MB	DS	SAMSUNG	K4B1G08460	1066-8-8-8-20	.		

DDR3-1333 MHz capability

Vendor	Part No.	Size	SS/DD	Chip Brand	Chip No.	CL	DIMM Support		
							A*	B*	C*
A-Data	AD31333001GOU	1024MB	SS	A-Data	AD30908C8D-151C E0906	N/A	.	.	.
A-Data	AD31333002GOU	2048MB	DS	A-Data	AD30908C8D-151C E0903	N/A	.	.	.
Apacer	78.01GC6.9L0	1024MB	SS	Apacer	AM5D5808AEWSBG0914E	9	.	.	.
Apacer	78.A1GC6.9L1	2048MB	DS	Apacer	AM5D5808AEWSBG0908D	9	.	.	.
Corsair	CM3X1024-1333C9DHX	1024MB	SS	N/A	Heat-Sink Package	N/A	.	.	.
Corsair	CM3X1024-1333C9	1024MB	SS	N/A	Heat-Sink Package	N/A	.	.	.
CORSAIR	TR3X3G1333C9	3072MB(Kit of 3)	SS	N/A	Heat-Sink Package	9	.	.	.
Corsair	CM3X1024-1333C9DHX	1024MB	DS	Corsair	Heat-Sink Package	N/A	.	.	.
Corsair	CM3X2048-1333C9DHX	2048MB	DS	N/A	Heat-Sink Package	N/A	.	.	.
Crucial	MT8JTF12864AY-1G4D1	3072MB(Kit of 3)	DS	Micron	9FD22D9JNM	9	.	.	.
Crucial	BL25664ABA1336.16SFB1	4096MB(Kit of 2)	DS	N/A	Heat-Sink Package	6-6-6-20	.	.	.
Crucial	MT16JTF25664AY-1G4D1	6144MB(Kit of 3)	DS	Micron	8UD22D9JNM	9	.	.	.
G.SKILL	F3-10600CL8D-2GBHK	1024MB	SS	G.SKILL	Heat-Sink Package	N/A	.	.	.
G.SKILL	F3-10600CL9D-2GBPK	1024MB	SS	G.SKILL	Heat-Sink Package	N/A	.	.	.
G.SkiLL	F3-10666CL7T-3GBPK	3072MB(Kit of 3)	SS	N/A	Heat-Sink Package	7-7-7-18	.	.	.
G.SkiLL	F3-10666CL9T-3GBNQ	3072MB(Kit of 3)	SS	N/A	Heat-Sink Package	9-9-9-24	.	.	.
G.SKILL	F3-10600CL7D-2GBPI	1024MB	DS	G.SKILL	Heat-Sink Package	N/A	.	.	.
G.SKILL	F3-10600CL9D-2GBNQ	1024MB	DS	G.SKILL	Heat-Sink Package	N/A	.	.	.
G.SKILL	F3-10666CL9D-4GBPK	2048MB	DS	G.SKILL	Heat-Sink Package	N/A	.	.	.
G.SkiLL	F3-10666CL7T-6GBPK	6144MB(Kit of 3)	DS	N/A	Heat-Sink Package	7-7-7-18	.	.	.
G.SKILL	F3-1066CL9T-6GBNQ	6144MB(Kit of 3)	DS	N/A	Heat-Sink Package	9-9-9-24	.	.	.
GEIL	DDR3-1333 CL9-9-9-24	1024MB	SS	N/A	Heat-Sink Package	9	.	.	.
GEIL	GV34GB1333C7DC	2048MB	DS	N/A	Heat-Sink Package	7-7-7-24	.	.	.
GEIL	DDR3-1333 CL9-9-9-24	6144MB(Kit of 3)	DS	N/A	Heat-Sink Package	9	.	.	.
kingmax	FLFD45F-B8MF9	1024MB	SS	Micron	8HD22D9JNM	N/A	.	.	.
kingmax	FLFE85F-B8MF9	2048MB	DS	Micron	8HD22D9JNM	N/A	.	.	.
Kingston	KVR1333D3N9/1G	1024MB	SS	elpida	J1108BABG-DJ-E	9	.	.	.
Kingston	KVR1333D3N9/2G	2048MB	DS	elpida	J1108BABG-DJ-E	9	.	.	.
Micron	MT8JTF12864AY-1G4D1	1024MB	SS	Micron	8LD22D9JNM	N/A	.	.	.
Micron	MT16JTF25664AY-1G1D1	2048MB	DS	Micron	8LD22 D9JNM	N/A	.	.	.
Micron	MT8JTF12864AY-1G4D1	3072MB(Kit of 3)	DS	Micron	9FD22D9JNM	9	.	.	.
Micron	MT16JTF25664AY-1G4D1	6144MB(Kit of 3)	DS	Micron	8UD22D9JNM	9	.	.	.
OCZ	OCZ3P13332GK	2048MB(Kit of 2)	SS	N/A	Heat-Sink Package	7-7-7-20	.	.	.
OCZ	OCZ3X1333LV3GK(XMP)	3072MB(Kit of 3)	SS	N/A	Heat-Sink Package	N/A	.	.	.
OCZ	OCZ3P13334GK	4096MB(Kit of 2)	DS	N/A	Heat-Sink Package	7-7-7-20	.	.	.
OCZ	OCZ3P13334GK	4096MB(Kit of 2)	DS	N/A	Heat-Sink Package	7-7-7-20	.	.	.
OCZ	OCZ3RPX1333EB4GK	4096MB(Kit of 2)	DS	N/A	Heat-Sink Package	6-5-5-20	.	.	.
Qimonda	IMSH1GU03A1F1C-13H	1024MB	SS	Qimonda	IDS1HG-03A1F1C-13HFSS10513	N/A	.	.	.
Qimonda	IMSH2GU13A1F1C-13H	2048MB	DS	Qimonda	IDS1HG-03A1F1C-13HFSS10275	N/A	.	.	.
Samsung	M378B2873DZ1-CH9	1024MB	SS	Samsung	K4B1G0846D-HCH9	N/A	.	.	.
SAMSUNG	M378B2873DZ1-CH9	1024MB	SS	SAMSUNG	SEC 846 HCH9 K4B1G08460	N/A	.	.	.
Samsung	M378B2873EH1-CH9	1024MB	SS	Samsung	SEC 913 HCH9 K4B1G0846E	N/A	.	.	.
Samsung	M391B2873DZ1-CH9	1024MB	SS	Samsung	K4B1G0846D-HCH9	N/A	.	.	.
Samsung	M378B5673DZ1-CH9	2048MB	DS	Samsung	K4B1G0846D-HCH9	N/A	.	.	.

(continued on the next page)

DDR3-1333 MHz capability

Vendor	Part No.	Size	SS/DD	Chip Brand	Chip No.	CL	DIMM Support		
							A*	B*	C*
Samsung	M378B5673EH1-CH9	2048MB	DS	Samsung	SEC 913 HCH9 K4B1G0846E	N/A	*	*	*
Samsung	M391B5673DZ1-CH9	2048MB	DS	Samsung	K4B1G0846D-HCH9	N/A	*	*	*
Super Talent	W133X2GB8	1024MB	SS	N/A	Heat-Sink Package	N/A	*	*	*
Transcend	SEC 813HCH9 K4B1G0846D	1024MB	SS	N/A	TS128MLK64V3U	N/A	*	*	*
Transcend	SEC816HCH9K4B1G0846D	2048MB	DS	N/A	TS256MLK64V3U	N/A	*	*	*
ASint	SLY3128M8-EDJ	1024MB	SS	ASint	DDR11208-DJ 0844	N/A	*	*	*
ASint	SLY3128M8-EDJ	2048MB	DS	ASint	DDR11208-DJ 0844	N/A	*	*	*
CENTURY	PC3-10600 DDR3-1333 9-9-9	1024MB	SS	Micron	8FD22D9JNM	N/A	*	*	*
CENTURY	PC3-10600 DDR3-1333 9-9-9	2048MB	DS	Micron	8DD22D9JNM	N/A	*	*	*
Elixir	M2CB1G80AN-BE	2048MB	DS	Elixir	M2F2G64CB8HA4N-BE	N/A	*	*	*
Kingtiger	2GB DIMM PC3-10666	2048MB	DS	Samsung	SEC 904 HCH9 K4B1G0846D	N/A	*	*	*
Kingtiger	KTG2G1333PG3	2048MB	DS	N/A	Heat-Sink Package	N/A	*	*	*
PATRIOT	PSD31G13332H	1024MB	DS	N/A	Heat-Sink Package	9	*	*	*
Patriot	PSD31G13332	1024MB	DS	Patriot	PM64M8D38U-15	N/A	*	*	*
Patriot	PSD32G13332H	2048MB	DS	N/A	Heat-Sink Package	N/A	*	*	*
PATRIOT	PDC34G1333ELK	4096MB(Kit of 2)	DS	N/A	Heat-Sink Package	9-9-9-24	*	*	*
Takems	TMS1GB364D081-107EY	1024MB	SS	N/A	Heat-Sink Package	7-7-7-20	*	*	*
Takems	TMS1GB364D081-138EY	1024MB	SS	N/A	Heat-Sink Package	8-8-8-24	*	*	*
Takems	TMS2GB364D081-107EY	2048MB	DS	N/A	Heat-Sink Package	7-7-7-20	*	*	*
Takems	TMS2GB364D081-138EY	2048MB	DS	N/A	Heat-Sink Package	8-8-8-24	*	*	*

DDR3-1066 MHz capability

Vendor	Part No.	Size	SS/DD	Chip Brand	Chip No.	CL	DIMM Support		
							A*	B*	C*
Elpida	EBJ51UD8BAFA-AC-E	512MB	SS	elpida	J5308BASE-AC-E	N/A	*	*	*
Elpida	EBJ51UD8BAFA-AE-E	512MB	SS	elpida	J5308BASE-AC-E	N/A	*	*	*
Elpida	EBJ11UD8BAFA-AE-E	1024MB	DS	elpida	J5308BASE-AC-E	N/A	*	*	*
G.SKILL	F3-8500CL6D-2GBHK	1024MB	SS	G.SKILL	Heat-Sink Package	N/A	*	*	*
Kingston	KVR1066D3N7/1G	1024MB	SS	elpida	J1108BABG-DJ-E	7	*	*	*
Kingston	KVR1066D3N7/1G	1024MB	SS	elpida	J5308BASE-AE-E S	7	*	*	*
Kingston	KVR1066D3N7/2G	2048MB	DS	elpida	J1108BABG-DJ-E	7	*	*	*
Micron	MT8JTF12864AY-1G1D1	1024MB	SS	Micron	8ED22D9JNL	N/A	*	*	*
Micron	MT16JTF25664AY-1G1D1	2048MB	DS	Micron	8LD22D9JNL	N/A	*	*	*
OCZ	OCZ3SOE10662GK	2048MB(Kit of 2)	DS	N/A	Heat-Sink Package	7-7-7-16	*	*	*
Qimonda	IMSH1GU03A1F1C-10F	1024MB	SS	Qimonda	IDSH1G-03A1F1C-10FFSS15085	N/A	*	*	*
Qimonda	IMSH1GU03A1F1C-10G	1024MB	SS	Qimonda	IDSH1G-03A1F1C-10GFSS14526	N/A	*	*	*
Qimonda	IMSH2GU03A1F1C-10F	2048MB	DS	Qimonda	IDSH1G-03A1F1C-10FFSS15085	N/A	*	*	*
Qimonda	IMSH2GU03A1F1C-10G	2048MB	DS	Qimonda	IDSH1G-03A1F1C-10GFSS13467	N/A	*	*	*
Samsung	M378B2873CZ0-CF8	1024MB	SS	Samsung	K4B1G0846C-ZCF8	N/A	*	*	*
Samsung	M378B2873CZ0-CG8	1024MB	SS	Samsung	K4B1G0846C-ZCG8	N/A	*	*	*
SAMSUNG	M378B5273BH1-CF8	4096MB	DS	SAMSUNG	846 K4B2G0846B-HCF8	N/A	*	*	*
Kingtiger	2GB DIMM PC3-8500	2048MB	DS	Hynix	H5TQ1G83AFP G7C	N/A	*	*	*



**SS - Single-sided / DS - Double - sided
DIMM support:**

- **A*:** Supports one module inserted into any slot as Single-channel memory configuration.
 - **B*:** Supports one pair of modules inserted into either the orange or black slots as one pair of Dual-channel memory configuration.
 - **C*:** Supports four modules inserted into both the orange and black slots as two pairs of Dual-channel memory configuration.
-



Visit the ASUS website at www.asus.com for the latest QVL.

1.7.3 Installing a DIMM



Unplug the power supply before adding or removing DIMMs or other system components. Failure to do so can cause severe damage to both the motherboard and the components.

To install a DIMM:

1. Press the retaining clips outward to unlock a DDR3 DIMM socket.
2. Align a DIMM on the socket such that the notch on the DIMM matches the break on the socket.

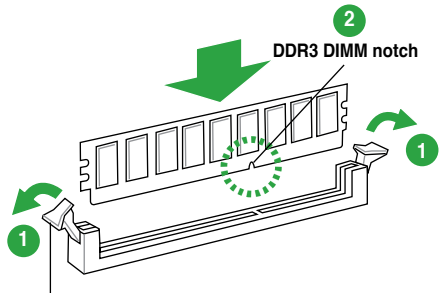

Unlocked retaining clip



A DDR3 DIMM is keyed with a notch so that it fits in only one direction. DO NOT force a DIMM into a socket to avoid damaging the DIMM.

3. Firmly insert the DIMM into the socket until the retaining clips snap back in place and the DIMM is properly seated.

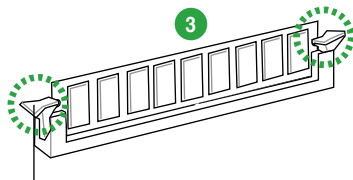

Locked Retaining Clip

1.7.4 Removing a DIMM

To remove a DIMM:

1. Simultaneously press the retaining clips outward to unlock the DIMM.



Support the DIMM lightly with your fingers when pressing the retaining clips. The DIMM might get damaged when it flips out with extra force.

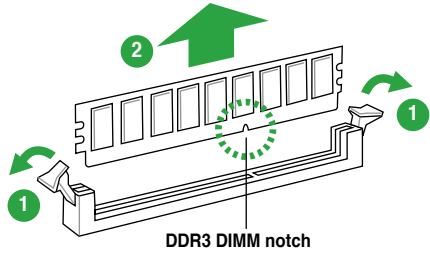

2. Remove the DIMM from the socket.

1.8 Expansion slots

In the future, you may need to install expansion cards. The following sub-sections describe the slots and the expansion cards that they support.



Unplug the power cord before adding or removing expansion cards. Failure to do so may cause you physical injury and damage motherboard components.

1.8.1 Installing an expansion card

To install an expansion card:

1. Before installing the expansion card, read the documentation that came with it and make the necessary hardware settings for the card.
2. Remove the system unit cover (if your motherboard is already installed in a chassis).
3. Remove the bracket opposite the slot that you intend to use. Keep the screw for later use.
4. Align the card connector with the slot and press firmly until the card is completely seated on the slot.
5. Secure the card to the chassis with the screw you removed earlier.
6. Replace the system cover.

1.8.2 Configuring an expansion card

After installing the expansion card, configure it by adjusting the software settings.

1. Turn on the system and change the necessary BIOS settings, if any. See Chapter 2 for information on BIOS setup.
2. Assign an IRQ to the card.
3. Install the software drivers for the expansion card.



When using PCI cards on shared slots, ensure that the drivers support "Share IRQ" or that the cards do not need IRQ assignments. Otherwise, conflicts will arise between the two PCI groups, making the system unstable and the card inoperable.

1.8.3 PCI slots

The PCI slots support cards such as a LAN card, SCSI card, USB card, and other cards that comply with PCI specifications.

1.8.4 PCI Express x1 slots

This motherboard supports PCI Express x1 network cards, SCSI cards, and other cards that comply with the PCI Express specifications.

1.8.5 PCI Express x16 slot

This motherboard supports a PCI Express x16 graphics card that complies with the PCI Express specifications.

1.9 Jumpers

1. Clear RTC RAM (3-pin CLRTC)

This jumper allows you to clear the Real Time Clock (RTC) RAM in CMOS. You can clear the CMOS memory of date, time, and system setup parameters by erasing the CMOS RTC RAM data. The onboard button cell battery powers the RAM data in CMOS, which include system setup information such as system passwords.

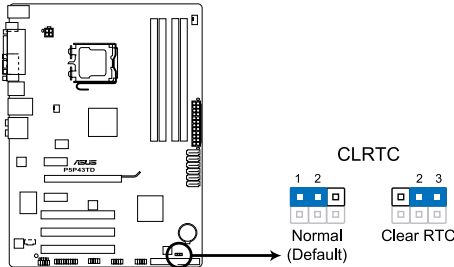

P5P43TD Clear RTC RAM

To erase the RTC RAM:

1. Turn OFF the computer and unplug the power cord.
2. Move the jumper cap from pins 1-2 (default) to pins 2-3. Keep the cap on pins 2-3 for about 5-10 seconds, then move the cap back to pins 1-2.
3. Plug the power cord and turn ON the computer.
4. Hold down the **** key during the boot process and enter BIOS setup to re-enter data.



Except when clearing the RTC RAM, never remove the cap on CLRTC jumper default position. Removing the cap will cause system boot failure!



- If the steps above do not help, remove the onboard battery and move the jumper again to clear the CMOS RTC RAM data. After the CMOS clearance, reinstall the battery.
 - You do not need to clear the RTC when the system hangs due to overclocking. For system failure due to overclocking, use the CPU Parameter Recall (C.P.R.) feature. Shut down and reboot the system, then the BIOS automatically resets parameter settings to default values.
 - Due to the chipset limitation, AC power off is required before you use the C.P.R. function. You must turn off and on the power supply or unplug and plug the power cord before rebooting the system.
-

1.10 Connectors

1.10.1 Rear panel connectors

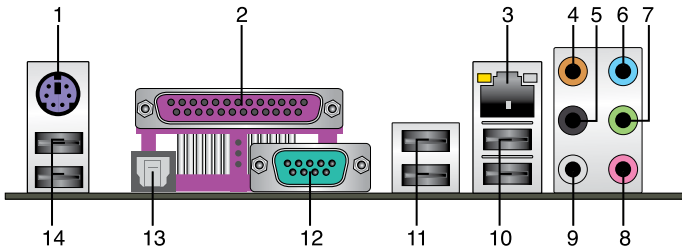

1. **PS/2 Keyboard/Mouse Combo port (purple)**. This port is for a PS/2 keyboard or mouse.
2. **Parallel port**. This 25-pin port connects a parallel printer, a scanner, or other devices.
3. **LAN (RJ-45) port**. This port allows Gigabit connection to a Local Area Network (LAN) through a network hub. Refer to the table below for the LAN port LED indications.

LAN port LED indications

ACT/LINK LED		SPEED LED	
Status	Description	Status	Description
OFF	No link	OFF	10 Mbps connection
ORANGE	Linked	ORANGE	100 Mbps connection
BLINKING	Data activity	GREEN	1 Gbps connection

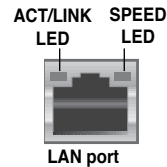

4. **Center / Subwoofer port (orange)**. This port connects the center/subwoofer speakers.
5. **Rear Speaker Out port (black)**. This port connects the rear speakers in a 4-channel, 6-channel, or 8-channel audio configuration.
6. **Line In port (light blue)**. This port connects the tape, CD, DVD player, or other audio sources.
7. **Line Out port (lime)**. This port connects a headphone or a speaker. In 4-channel, 6-channel, and 8-channel configurations, the function of this port becomes Front Speaker Out.
8. **Microphone port (pink)**. This port connects a microphone.
9. **Side Speaker Out port (gray)**. This port connects the side speaker in an 8-channel audio configuration.



Refer to the audio configuration table on the next page for the function of the audio ports in 2, 4, 6, 6, or 8-channel configuration.

Audio 2, 4, 6, or 8-channel configuration

Port	Headset 2-channel	4-channel	6-channel	8-channel
Light Blue	Line In	Line in	Line in	Line in
Lime	Line Out	Front Speaker Out	Front Speaker Out	Front Speaker Out
Pink	Mic In	Mic In	Mic in	Mic in
Orange	-	-	Center/Subwoofer	Center/Subwoofer
Black	-	Rear Speaker Out	Rear Speaker Out	Rear Speaker Out
Gray	-	-	-	Side Speaker Out

- USB 2.0 ports 1 and 2.** These two 4-pin Universal Serial Bus (USB) ports are available for connecting USB 2.0 devices.
- USB 2.0 ports 3 and 4.** These two 4-pin Universal Serial Bus (USB) ports are available for connecting USB 2.0 devices.
- COM port.** This 9-pin COM1 port is for pointing devices or other serial devices.
- Optical S/PDIF Out port.** This port connects an external audio output device via an optical S/PDIF cable.
- USB 2.0 ports 5 and 6.** These two 4-pin Universal Serial Bus (USB) ports are available for connecting USB 2.0 devices.

1.10.2 Internal connectors

1. CPU and chassis fan connectors (4-pin CPU_FAN, 3-pin CHA_FAN)

The fan connectors support cooling fans of 350 mA~2000 mA (24 W max.) or a total of 1 A~3.48 A (41.76 W max.) at +12V. Connect the fan cables to the fan connectors on the motherboard, ensuring that the black wire of each cable matches the ground pin of the connector.



Do not forget to connect the fan cables to the fan connectors. Insufficient air flow inside the system may damage the motherboard components. These are not jumpers! Do not place jumper caps on the fan connectors!

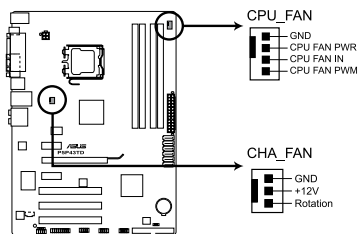

P5P43TD fan connectors



Only the CPU fan supports the ASUS Q-FAN feature.

2. ATX power connectors (24-pin EATXPWR, 4-pin ATX12V)

These connectors are for ATX power supply plugs. The power supply plugs are designed to fit these connectors in only one orientation. Find the proper orientation and push down firmly until the connectors completely fit.

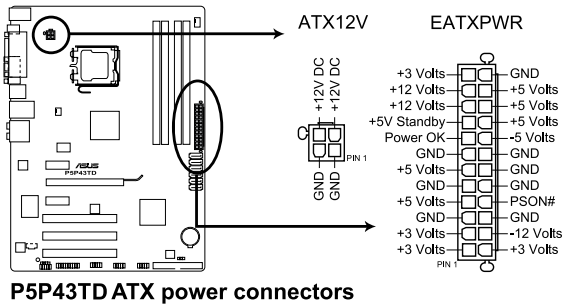

- For a fully configured system, we recommend that you use a power supply unit (PSU) that complies with ATX 12 V Specification 2.0 (or later version) and provides a minimum power of 400 W.
- Do not forget to connect the 4-pin ATX12V power plug. Otherwise, the system will not boot.
- We recommend that you use a PSU with a higher power output when configuring a system with more power-consuming devices or when you intend to install additional devices. The system may become unstable or may not boot up if the power is inadequate.

3. Digital audio connector (4-1 pin SPDIF_OUT)

This connector is for an additional Sony/Philips Digital Interface (S/PDIF) port. Connect the S/PDIF Out module cable to this connector, then install the module to a slot opening at the back of the system chassis.

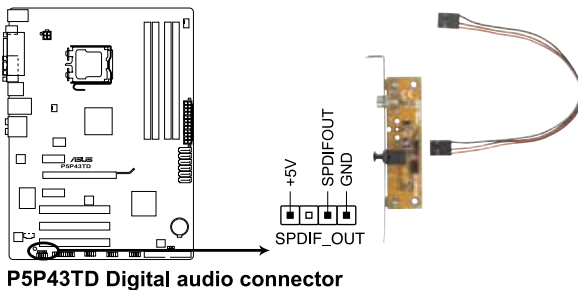

The S/PDIF module is purchased separately.

4. Serial ATA connectors (7-pin SATA1-6)

These connectors are for the Serial ATA signal cables for Serial ATA 3Gb/s hard disk and optical disk drives. The Serial ATA 3Gb/s is backward compatible with Serial ATA 1.5Gb/s specification. The data transfer rate of the Serial ATA 3Gb/s is faster than the standard parallel ATA with 133 MB/s (Ultra DMA133).

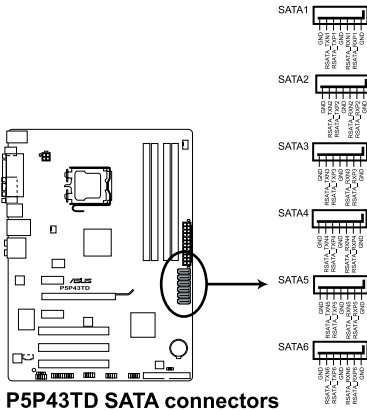

P5P43TD SATA connectors



Install the Windows® XP Service Pack 1 or later version before using Serial ATA.

5. Optical drive audio connector (4-pin CD)

These connectors allow you to receive stereo audio input from sound sources such as a CD-ROM, TV tuner, or MPEG card.

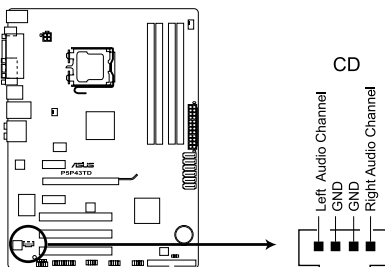

P5P43TD Internal audio connector

6. IDE connector (40-1 pin PRI_EIDE)

The onboard IDE connector is for the Ultra DMA 133/100/66 signal cable. There are three connectors on each Ultra DMA 133/100/66 signal cable: blue, black, and gray. Connect the blue connector to the motherboard's IDE connector, then select one of the following modes to configure your device.

	Drive jumper setting	Mode of device(s)	Cable connector
Single device	Cable-Select or Master	-	Black
Two devices	Cable-Select	Master	Black
		Slave	Gray
	Master	Master	Black or gray
	Slave	Slave	



- Pin 20 on the IDE connector is removed to match the covered hole on the Ultra DMA cable connector. This prevents incorrect insertion when you connect the IDE cable.
- Use the 80-conductor IDE cable for Ultra DMA 133/100/66 IDE devices.

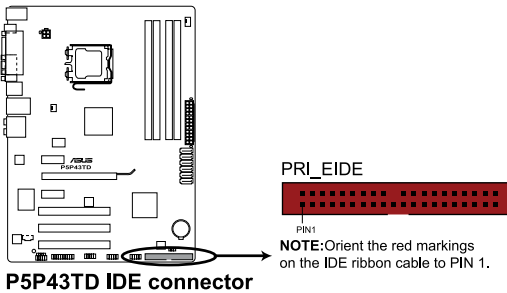

If any device jumper is set as "Cable-Select," ensure that all other device jumpers have the same setting.

7. System panel connector (20-8 pin PANEL)

This connector supports several chassis-mounted functions.

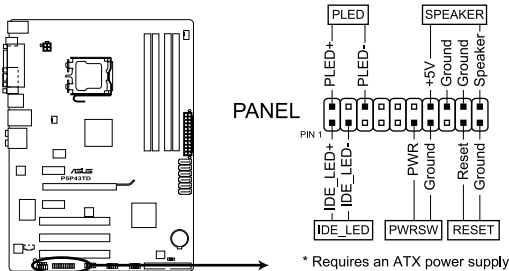

P5P43TD System panel connector

- **System power LED (2-pin PLED)**

This 2-pin connector is for the system power LED. Connect the chassis power LED cable to this connector. The system power LED lights up when you turn on the system power, and blinks when the system is in sleep mode.

- **Hard disk drive activity LED (2-pin IDE_LED)**

This 2-pin connector is for the HDD Activity LED. Connect the HDD Activity LED cable to this connector. The IDE LED lights up or flashes when data is read from or written to the HDD.

- **System warning speaker (4-pin SPEAKER)**

This 4-pin connector is for the chassis-mounted system warning speaker. The speaker allows you to hear system beeps and warnings.

- **ATX power button/soft-off button (2-pin PWRSW)**

This connector is for the system power button. Pressing the power button turns the system on or puts the system in sleep or soft-off mode depending on the BIOS settings. Pressing the power switch for more than four seconds while the system is ON turns the system OFF.

- **Reset button (2-pin RESET)**

This 2-pin connector is for the chassis-mounted reset button for system reboot without turning off the system power.

8. USB connectors (10-1 pin USB78, USB910, USB1112)

These connectors are for USB 2.0 ports. Connect the USB module cable to any of these connectors, then install the module to a slot opening at the back of the system chassis. These USB connectors comply with USB 2.0 specification that supports up to 480 Mbps connection speed.

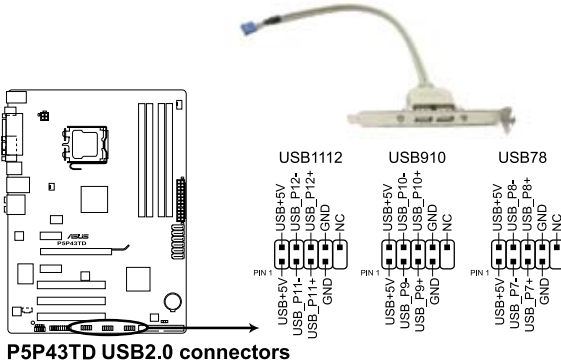

Never connect a 1394 cable to the USB connectors. Doing so will damage the motherboard!



The USB module cable is purchased separately.

9. Front panel audio connector (10-1 pin AAFF)

This connector is for a chassis-mounted front panel audio I/O module that supports either HD Audio or legacy AC'97 audio standard. Connect one end of the front panel audio I/O module cable to this connector.

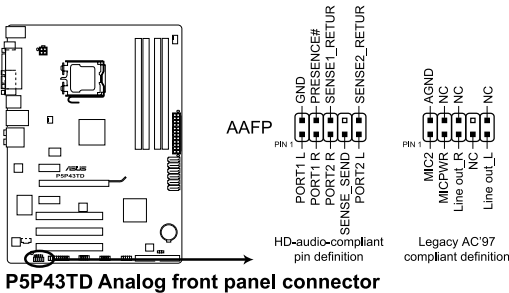

- We recommend that you connect a high-definition front panel audio module to this connector to avail of the motherboard's high-definition audio capability.
- If you want to connect a high-definition front panel audio module to this connector, set the **Front Panel Type** item in the BIOS setup to **[HD Audio]**. If you want to connect an AC'97 front panel audio module to this connector, set the item to **[AC97]**. By default, this connector is set to **[HD Audio]**. See section **2.5.3 Onboard Devices Configuration** for details.

1.11 Software support

1.11.1 Installing an operating system

This motherboard supports Windows® XP/Vista Operating Systems (OS). Always install the latest OS version and corresponding updates to maximize the features of your hardware.



- Motherboard settings and hardware options vary. Refer to your OS documentation for detailed information.
- Ensure that you install Windows® XP Service Pack 3 or later versions / Windows® Vista Service Pack 1 or later versions before installing the drivers for better compatibility and system stability.

1.11.2 Support DVD information

The Support DVD that comes with the motherboard package contains the drivers, software applications, and utilities that you can install to avail all motherboard features.



The contents of the Support DVD are subject to change at any time without notice. Visit the ASUS website at www.asus.com for updates.

To run the Support DVD

Place the Support DVD to the optical drive. The DVD automatically displays the Drivers menu if Autorun is enabled in your computer.



The following screen is for reference only.



Click an icon to display Support DVD/ motherboard information

Click an item to install



If Autorun is NOT enabled in your computer, browse the contents of the Support DVD to locate the file ASSETUP.EXE from the BIN folder. Double-click the ASSETUP.EXE to run the DVD.

Chapter 2

BIOS information

2.1 Managing and updating your BIOS



Save a copy of the original motherboard BIOS file to a USB flash disk in case you need to restore the BIOS in the future. Copy the original motherboard BIOS using the ASUS Update utility.

2.1.1 ASUS Update utility

The ASUS Update is a utility that allows you to manage, save, and update the motherboard BIOS in Windows® environment.



- ASUS Update requires an Internet connection either through a network or an Internet Service Provider (ISP).
 - This utility is available in the support DVD that comes with the motherboard package.
-

Installing ASUS Update

To install ASUS Update:

1. Place the support DVD in the optical drive. The **Drivers** menu appears.
2. Click the **Utilities** tab, then click **ASUS Update**.
3. Follow the onscreen instructions to complete the installation.



Quit all Windows® applications before you update the BIOS using this utility.

Updating the BIOS

To update the BIOS:

1. From the Windows® desktop, click **Start > Programs > ASUS > ASUSUpdate > ASUSUpdate** to launch the ASUS Update utility.
2. From the dropdown list, select any of the updating process:
 - Updating from the Internet*
 - a. Select **Update BIOS from the Internet**, then click **Next**.
 - b. Select the ASUS FTP site nearest you to avoid network traffic, or click **Auto Select** then click **Next**.
 - c. From the FTP site, select the BIOS version that you wish to download then click **Next**.



The ASUS Update utility is capable of updating itself through the Internet. Always update the utility to avail all its features.

Updating from a BIOS file

- a. Select **Update BIOS from a file**, then click **Next**.
 - b. Locate the BIOS file from the **Open** window, then click **Open**.
3. Follow the onscreen instructions to complete the updating process.

2.1.2 ASUS EZ Flash 2 utility

The ASUS EZ Flash 2 feature allows you to update the BIOS without using an OS-based utility.



Before you start using this utility, download the latest BIOS file from the ASUS website at www.asus.com.

To update the BIOS using EZ Flash 2:

1. Insert the USB flash disk that contains the latest BIOS file to the USB port, then launch EZ Flash 2 in any of these two ways:
 - Press **<Alt> + <F2>** during POST to display the following:

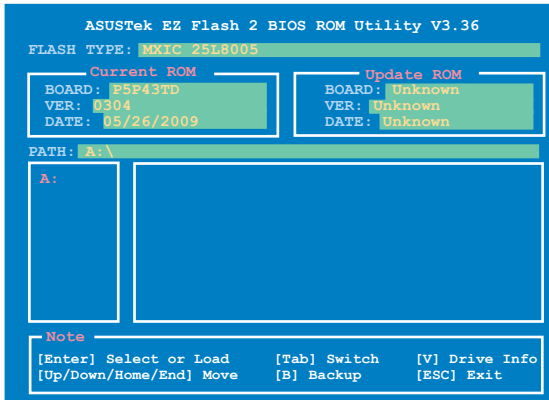

- Enter the BIOS setup program. Go to the **Tools** menu to select **EZ Flash 2** and press **<Enter>** to enable it.
Press **<Tab>** to switch between drives until the correct BIOS file is found.
2. When the correct BIOS file is found, EZ Flash 2 performs the BIOS update process and automatically reboots the system when done.



-
- Only a USB flash disk with **FAT 32/16** format and single partition can support the ASUS EZ Flash 2 utility.
 - Do not shut down or reset the system while updating the BIOS to prevent system boot failure!
-

2.1.3 ASUS CrashFree BIOS 3 utility

The ASUS CrashFree BIOS 3 is an auto recovery tool that allows you to restore the BIOS file when it fails or gets corrupted during the updating process. You can update a corrupted BIOS file using the motherboard support DVD or a USB flash disk that contains the updated BIOS file.



-
- Prepare the motherboard support DVD or the USB flash disk containing the updated motherboard BIOS before using this utility.
 - Always connect the SATA cable to the SATA1 / SATA 2 connector. Otherwise, the utility will not function.
-

Recovering the BIOS

To recover the BIOS:

1. Turn on the system.
2. Insert the support DVD or USB flash disk containing the BIOS file to the optical drive or USB port.
3. The utility displays the following message and automatically checks the support DVD or USB flash disk for the BIOS file.

```
Bad BIOS checksum. Starting BIOS recovery...
Checking for CD-ROM...
CD-ROM not found!
Checking for USB Device...
```

When found, the utility reads the BIOS file and starts erasing the corrupted BIOS file.

```
Bad BIOS checksum. Starting BIOS recovery...
Checking for USB Device...
USB Device found.
Reading file "P5P43TD.ROM". Completed.
Start Erasing...\
```

4. Restart the system after the utility completes the updating process.



- Only a USB flash disk with FAT 32/16 format and single partition can support ASUS CrashFree BIOS 3. The device size should be smaller than 8GB.
- DO NOT shut down or reset the system while updating the BIOS! Doing so can cause system boot failure!



The recovered BIOS may not be the latest BIOS version for this motherboard. Download the latest BIOS file from the ASUS website at www.asus.com.

2.2 BIOS setup program

This motherboard supports a programmable Serial Peripheral Interface (SPI) chip that you can update using the provided utility described in section “2.1 Managing and updating your BIOS.”

Use the BIOS Setup program when you are installing a motherboard, reconfiguring your system, or prompted to “Run Setup.” This section explains how to configure your system using this utility.

Even if you are not prompted to use the Setup program, you can change the configuration of your computer in the future. For example, you can enable the security password feature or change the power management settings. This requires you to reconfigure your system using the BIOS Setup program so that the computer can recognize these changes and record them in the CMOS RAM of the SPI chip.

The SPI chip on the motherboard stores the Setup utility. When you start up the computer, the system provides you with the opportunity to run this program. Press **** during the Power-On Self-Test (POST) to enter the Setup utility. Otherwise, POST continues with its test routines.

If you wish to enter Setup after POST, reboot the system by doing any of the following procedures:

- Restart using the OS standard shutdown procedure.
- Press **<Ctrl>+<Alt>+** simultaneously.
- Press the reset button on the system chassis.
- Press the power button to turn the system off then back on.



Using the **power button**, **reset button**, or the **<Ctrl>+<Alt>+** keys to force reset from a running operating system can cause damage to your data or system. We recommend to always shut down the system properly from the operating system.

The Setup program is designed to make it as easy to use as possible. Being a menu-driven program, it lets you scroll through the various submenus and make your selections from the available options using the navigation keys.



- The default BIOS settings for this motherboard apply for most conditions to ensure optimum performance. If the system becomes unstable after changing any BIOS settings, load the default settings to ensure system compatibility and stability. Select the **Load Setup Defaults** item under the Exit Menu. See section 2.9 **Exit Menu**.
- The BIOS setup screens shown in this section are for reference purposes only, and may not exactly match what you see on your screen.
- Visit the ASUS website at www.asus.com to download the latest BIOS file for this motherboard.

2.2.1 BIOS menu screen

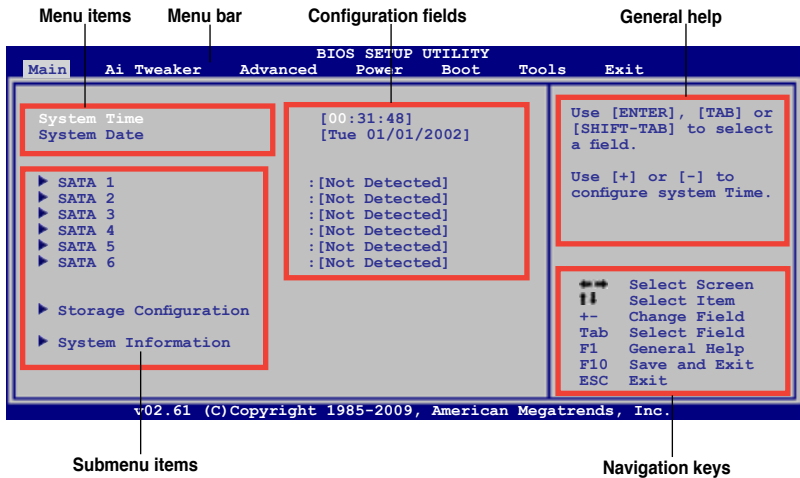

2.2.2 Menu bar

The menu bar on top of the screen has the following main items:

- Main** For changing the basic system configuration.
- Ai Tweaker** For changing system performance settings
- Advanced** For changing the advanced system settings.
- Power** For changing the advanced power management (APM) configuration.
- Boot** For changing the system boot configuration.
- Tools** For configuring options for special functions.
- Exit** For selecting the exit options and loading default settings.

To select an item on the menu bar, press the right or left arrow key on the keyboard until the desired item is highlighted.

2.2.3 Navigation keys

At the bottom right corner of a menu screen are the navigation keys for that particular menu. Use the navigation keys to select items in the menu and change the settings.



Some of the navigation keys differ from one screen to another.

2.2.4 Menu items

The highlighted item on the menu bar displays the specific items for that menu. For example, selecting Main shows the Main menu items.

The other items (Ai Tweaker, Advanced, Power, Boot, Tools, and Exit) on the menu bar have their respective menu items.

2.2.5 Submenu items

A solid triangle before each item on any menu screen means that the item has a submenu. To display the submenu, select the item and press **<Enter>**.

2.2.6 Configuration fields

These fields show the values for the menu items. If an item is user-configurable, you can change the value of the field opposite the item. You cannot select an item that is not user-configurable. A configurable field is enclosed in brackets, and is highlighted when selected. To change the value of a field, select it then press **<Enter>** to display a list of options. Refer to **2.2.7 Pop-up window**.

2.2.7 Pop-up window

Select a menu item then press **<Enter>** to display a pop-up window with the configuration options for that item.

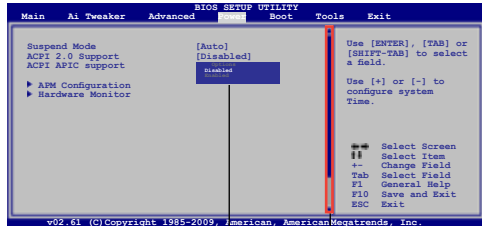

Pop-up window

Scroll bar

2.2.8 Scroll bar

A scroll bar appears on the right side of a menu screen when there are items that do not fit on the screen. Press the **<Up>** / **<Down>** arrow keys or **<Page Up>** / **<Page Down>** keys to display the other items on the screen.

2.2.9 General help

At the top right corner of the menu screen is a brief description of the selected item.

2.3 Main menu

When you enter the BIOS Setup program, the **Main** menu screen appears, giving you an overview of the basic system information.



Refer to section 2.2.1 **BIOS menu screen** for information on the menu screen items and how to navigate through them.

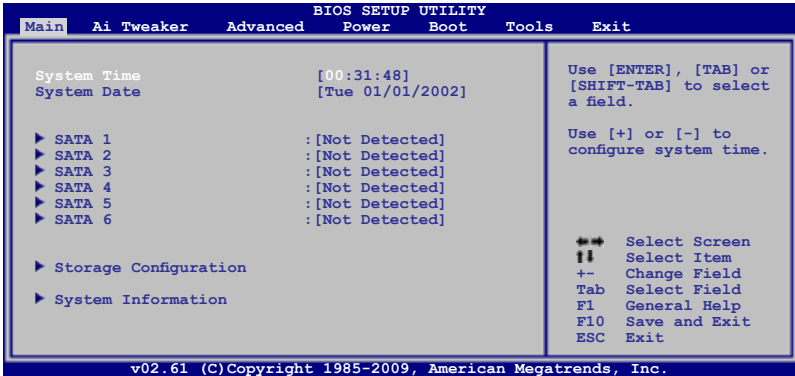

2.3.1 System Time [xx:xx:xx]

Allows you to set the system time.

2.3.2 System Date [Day xx/xx/xxxx]

Allows you to set the system date.

2.3.3 SATA 1-6

While entering Setup, the BIOS automatically detects the presence of SATA devices. There is a separate sub-menu for each SATA device. Select a device item then press <Enter> to display the SATA device information.

The BIOS automatically detects the values opposite the dimmed items (Device, Vendor, Size, LBA Mode, Block Mode, PIO Mode, Async DMA, Ultra DMA, and SMART Monitoring). These values are not user-configurable. These items show Not Detected if no Serial ATA device is installed in the system.

Type [Auto]

Selects the type of SATA drive. Setting to [Auto] allows automatic selection of the appropriate SATA device type. Select [CDROM] if you are specifically configuring a CD-ROM drive. Select [ARMD] (ATAPI Removable Media Device) if your device is either a ZIP, LS-120, or MO drive. Configuration options: [Not Installed] [Auto] [CDROM] [ARMD]



This item only appears in the SATA 1-4 menus.

LBA/Large Mode [Auto]

Enables or disables the LBA mode. Setting to **[Auto]** enables the LBA mode if the device supports this mode, and if the device was not previously formatted with LBA mode disabled. Configuration options: [Disabled] [Auto]

Block (Multi-sector Transfer) M [Auto]

Enables or disables data multi-sectors transfers. When set to **[Auto]**, the data transfer from and to the device occurs multiple sectors at a time if the device supports multi-sector transfer feature. When set to **[Disabled]**, the data transfer from and to the device occurs one sector at a time. Configuration options: [Disabled] [Auto]

PIO Mode [Auto]

Selects the PIO mode. Configuration options: [Auto] [0] [1] [2] [3] [4]

DMA Mode [Auto]

Selects the DMA mode. Configuration options: [Auto]

SMART Monitoring [Auto]

Sets the Smart Monitoring, Analysis, and Reporting Technology. Configuration options: [Auto] [Disabled] [Enabled]

32Bit Data Transfer [Enabled]

Enables or disables 32-bit data transfer. Configuration options: [Disabled] [Enabled]

2.3.4 Storage Configuration

The items in this menu allow you to set or change the configurations for the SATA devices installed in the system. Select an item then press **<Enter>** if you want to configure the item.

SATA Configuration [Enhanced]

Allows you to set the SATA configuration. Configuration options: [Disabled] [Compatible] [Enhanced]

Configure SATA as [IDE]

Sets the configuration for the Serial ATA connectors supported by the Southbridge chip. Configuration options: [IDE] [AHCI]



Due to Intel chipset driver support regulation, the AHCI mode is not supported in Windows XP environment. The AHCI mode is only supported by Windows Vista with OS built-in driver.

Hard Disk Write Protect [Disabled]

Disables or enables device write protection. This will be effective only if device is accessed through BIOS. Configuration option: [Disabled] [Enabled]

IDE Detect Time Out (Sec) [35]

Selects the time out value for detecting ATA/ATAPI devices. Configuration options: [0] [5] [10] [15] [20] [25] [30] [35]

2.3.5 System Information

This menu gives you an overview of the general system specifications. The BIOS automatically detects the items in this menu.

Bios Information

Displays the auto-detected BIOS information.

Processor

Displays the auto-detected CPU specification.

System Memory

Displays the auto-detected system memory.

2.4 Ai Tweaker menu

The **Ai Tweaker** menu items allow you to change the settings for the CPU and other system devices.

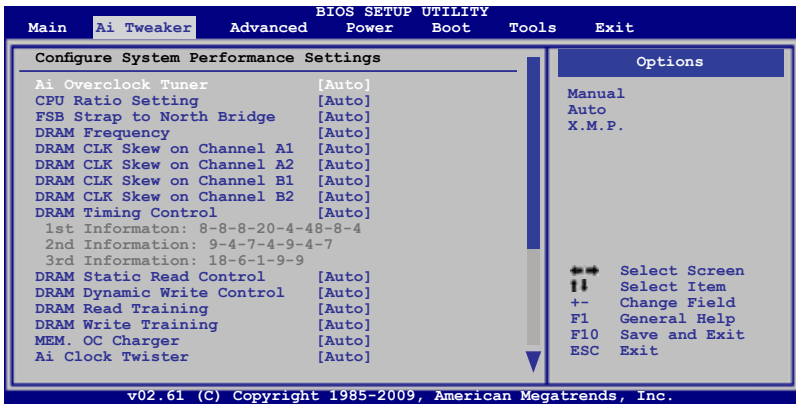

Scroll down to display the following items:

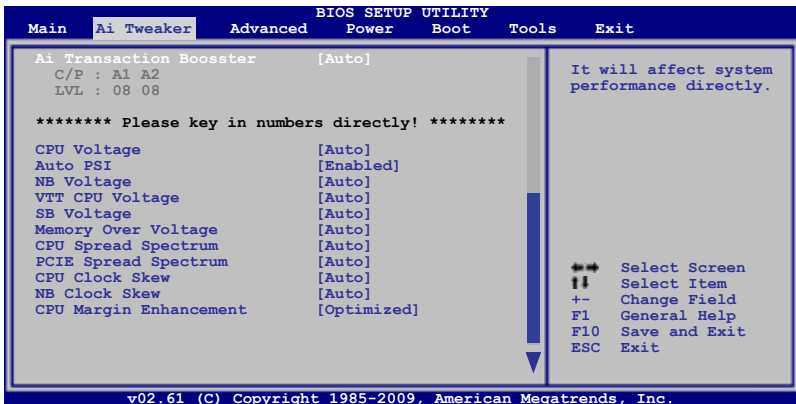

Ai Overclock Tuner [Auto]

Allows selection of CPU overclocking options to achieve desired CPU internal frequency. Select either one of the preset overclocking configuration options:

Manual - Allows you to individually set overclocking parameters.

Auto - Loads the optimal settings for the system.

X.M.P. - If you install memory module(s) supporting the eXtreme Memory Profile X.M.P.) Technology, choose this item to set the profile(s) supported by your memory module(s) for optimizing the system performance.



The following two items appear only when you set the **Ai Overclock Tuner** item to [Manual].

FSB Frequency [XXX]

Displays the frequency sent by the clock generator to the system bus and PCI bus. The value of this item is auto-detected by the BIOS. Input the desired CPU frequency using the numeric keypad. The values range from 200 to 800 MHz. Refer to the table below for the correct Front Side Bus and CPU External Frequency settings.

FSB/CPU External Frequency Synchronization

Front Side Bus	CPU External Frequency
FSB 1600	400 MHz
FSB 1333	333 MHz
FSB 1066	266 MHz
FSB 800	200 MHz

PCI Express Frequency [Auto]

Allows you to set the PCI Express frequency. Use the <+> and <-> keys to adjust the PCI Express frequency. The values range from 100 to 180.



The following configuration options for the following sub-item vary depending on the DIMMs you install on the motherboard.

eXtreme Memory Profile [Disabled]

This item appears only when you set the Ai Overclock Tuner item to [X.M.P.] and allows you to enable or disable the eXtreme Memory Profile.

Configuration options: [Disabled] [Enabled]

CPU Ratio Setting [Auto]

Allows you to set the ratio between CPU Core Clock and the FSB Frequency.

Configuration options: [Auto]

FSB Strap to North Bridge [Auto]

Allows you to adjust the FSB strap. Configuration options: [Auto] [200MHz] [266MHz] [333MHz] [400MHz]

DRAM Frequency [Auto]

Allows you to set the DDR3 operating frequency. Configuration options: [Auto] [DDR3-800MHz] [DDR3-1066MHz] [DDR3-*1600MHz*] [DDR3-*1800MHz*]

DRAM CLK Skew on Channel A1/A2/B1/B2 [Auto]

Allows you to set the DIMM clock skew on channel A1, A2, B1, and B2. Configuration options: [Auto] [Advance 350ps] [Advance 300ps] [Advance 250ps] [Advance 200ps] [Advance 150ps] [Advance 100ps] [Advance 50ps] [Normal] [Delay 50ps] [Delay 100ps] [Delay 150ps] [Delay 200ps] [Delay 250ps] [Delay300ps] [Delay 350ps]

DRAM Timing Control [Auto]

Allows you to select the DRAM timing configuration. Configuration options: [Auto] [Manual]



- The following items appear only when you set the **DRAM Timing Control** item to **[Manual]**.
- The configuration options for some of the following items vary depending on the DIMMs you install on the motherboard.

1st Information: 8-8-8-20-4-48-8-4

CAS# Latency [5DRAM Clocks]

Configuration options: [4 DRAM Clocks] [5 DRAM Clocks] [6 DRAM Clocks] [7 DRAM Clocks] [8 DRAM Clocks] [9 DRAM Clocks] [10 DRAM Clocks] [11 DRAM Clocks]

DRAM RAS# to CAS# Delay [5DRAM Clocks]

DRAM RAS# Precharge [5DRAM Clocks]

DRAM RAS# Activate to Precharge [15DRAM Clocks]

Configuration options: [3 DRAM Clocks] [4 DRAM Clocks] [5 DRAM Clocks] [6 DRAM Clocks] [7 DRAM Clocks] [8 DRAM Clocks] [9 DRAM Clocks] [10 DRAM Clocks] [11 DRAM Clocks] [12 DRAM Clocks] [13 DRAM Clocks] [14 DRAM Clocks] [15 DRAM Clocks] [16 DRAM Clocks] [17 DRAM Clocks] [18 DRAM Clocks]

RAS# to RAS# Delay [Auto]

Configuration options: [Auto] [1 DRAM Clocks] [2 DRAM Clocks] [3 DRAM Clocks] [4 DRAM Clocks] [5 DRAM Clocks] [6 DRAM Clocks] [7 DRAM Clocks] [8 DRAM Clocks] [9 DRAM Clocks] [10 DRAM Clocks] [11 DRAM Clocks] [12 DRAM Clocks] [13 DRAM Clocks] [14 DRAM Clocks] [15 DRAM Clocks]

Row Refresh Cycle Time [Auto]

Configuration options: [Auto] [30 DRAM Clocks] [36 DRAM Clocks] [48 DRAM Clocks] [60 DRAM Clocks] [72 DRAM Clocks] [82 DRAM Clocks] [88 DRAM Clocks] [90 DRAM Clocks] [100 DRAM Clocks] [110 DRAM Clocks]

Writer Recovery Time [Auto]

Read to Precharge Time [Auto]

Configuration options: [Auto] [1 DRAM Clocks] [2 DRAM Clocks] [3 DRAM Clocks] [4 DRAM Clocks] [5 DRAM Clocks] [6 DRAM Clocks] [7 DRAM Clocks] [8 DRAM Clocks] [9 DRAM Clocks] [10 DRAM Clocks] [11 DRAM Clocks] [12 DRAM Clocks] [13 DRAM Clocks] [14 DRAM Clocks] [15 DRAM Clocks]

2nd Information: 9-4-7-4-9-4-7

READ to WRITE Delay (S/D) [Auto]

WRITE to READ Delay (S) [Auto]

WRITE to READ Delay (D) [Auto]

READ to READ Delay (S) [Auto]

READ to READ Delay (D) [Auto]

WRITE to WRITE Delay (S) [Auto]

WRITE to WRITE Delay (D) [Auto]

Configuration options: [Auto] [1 DRAM Clocks] [2 DRAM Clocks] [3 DRAM Clocks] [4 DRAM Clocks] [5 DRAM Clocks] [6 DRAM Clocks] [7 DRAM Clocks] [8 DRAM Clocks] [9 DRAM Clocks] [10 DRAM Clocks] [11 DRAM Clocks] [12 DRAM Clocks] [13 DRAM Clocks] [14 DRAM Clocks] [15 DRAM Clocks]

3rd Information: 18-6-1-9-9

WRITE to PRE Delay [Auto]

Configuration options: [Auto] [1 DRAM Clocks] [2 DRAM Clocks] [3 DRAM Clocks] [4 DRAM Clocks] ... [29 DRAM Clocks] [30 DRAM Clocks] [31 DRAM Clocks]

READ to PRE Delay [Auto]

Configuration options: [Auto] [1 DRAM Clocks] [2 DRAM Clocks] [3 DRAM Clocks] [4 DRAM Clocks] [5 DRAM Clocks] [6 DRAM Clocks] [7 DRAM Clocks] [8 DRAM Clocks] [9 DRAM Clocks] [10 DRAM Clocks] [11 DRAM Clocks] [12 DRAM Clocks] [13 DRAM Clocks] [14 DRAM Clocks] [15 DRAM Clocks]

PRE to PRE Delay [Auto]

Configuration options: [Auto] [1 DRAM Clocks] [2 DRAM Clocks] [3 DRAM Clocks]

ALL PRE to ACT Delay [Auto]

ALL PRE to REF Delay [Auto]

Configuration options: [Auto] [1 DRAM Clocks] [2 DRAM Clocks] [3 DRAM Clocks] [4 DRAM Clocks] [5 DRAM Clocks] [6 DRAM Clocks] [7 DRAM Clocks] [8 DRAM Clocks] [9 DRAM Clocks] [10 DRAM Clocks] [11 DRAM Clocks] [12 DRAM Clocks] [13 DRAM Clocks] [14 DRAM Clocks] [15 DRAM Clocks]

DRAM Static Read Control [Auto]

Configuration options: [Auto] [Disabled] [Enabled]

DRAM Dynamic Write Control [Auto]

Configuration options: [Auto] [Disabled] [Enabled]

DRAM Read Training [Auto]

Configuration options: [Auto] [Disabled] [Enabled]

DRAM Write Training [Auto]

Configuration options: [Auto] [Disabled] [Enabled]

MEM. OC Charger [Auto]

Configuration options: [Auto] [Disabled] [Enabled]

Ai Clock Twister [Auto]

Allows you to set the DRAM performance. Configuration options: [Auto] [Lighter] [Light] [Moderate] [Strong] [Stronger]

Ai Transaction Booster [Auto]

Allows you to set the system performance. Configuration options: [Auto] [Manual]



The following items appear only when you set the **Ai Transaction Booster** item to **[Manual]**.

C/P : A1 A2

LVL : 08 08

Common Performance Level [05]

Set this item to a higher level for better compatibility or a lower level for better performance. Use the <+> and <-> keys to adjust the value.

Pull-In of CHA/CHB PH1/2 [Disabled]

Set this item to [Enabled] to apply enhancement on DRAM Channel A and B, Phase 1 and 2. The number of phases is determined by DRAM frequency and FSB strap. Configuration options: [Disabled] [Enabled]

CPU Voltage [Auto]

Allows you to set the CPU voltage. Configuration options: [Auto] [+50mv] [+100mv] [+150mv]



Refer to the CPU documentation before setting the CPU voltage. Setting a high voltage may damage the CPU permanently, and setting a low voltage may make the system unstable.

Auto PSI [Enabled]

Allows you to enable or disable the Auto PSI. Configuration options: [Enabled] [Disabled]

NB Voltage [Auto]

Allows you to set the North Bridge voltage. Configuration options: [Auto] [1.10V] [1.15V] [1.20V] [1.25V]

VTT CPU Voltage [Auto]

Allows you to set the VTT CPU voltage. Configuration options: [Auto] [1.2V] [1.3V]

SB Voltage [Auto]

Allows you to set the South Bridge voltage. Configuration options: [Auto] [1.5V] [1.6V]

Memory Over Voltage [Auto]

Allows you to set the memory over voltage. The values range from 1.50000V to 2.20500V with a 0.01500V interval. Use the <+> and <-> keys to adjust the value. Configuration options: [Auto]



Setting a high voltage may damage the component permanently, and setting a low voltage may make the system unstable.

2.5 Advanced menu

The **Advanced** menu items allow you to change the settings for the CPU and other system devices.



Take caution when changing the settings of the Advanced menu items. Incorrect field values can cause the system to malfunction.

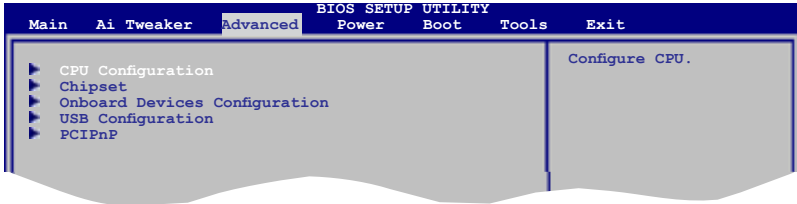

2.5.1 CPU Configuration

The items in this menu show the CPU-related information that the BIOS automatically detects.

CPU Ratio Setting [Auto]

Sets the ration between CPU core clock and the FSB frequency. Key in ratio numbers directly.



If an invalid ratio is set in CMOS, then the actual and set values may differ.

C1E Support [Enabled]

Allows you to enable or disable C1E Support. Configuration options: [Disabled] [Enabled]

Max CPUID Value Limit [Disabled]

Setting this item to **[Enabled]** allows legacy operating systems to boot even without support for CPUs with extended CPUID functions. Configuration options: [Disabled] [Enabled]

Intel(R) Virtualization Tech [Enabled]

Enables or disables Intel® Virtualization Technology. Virtualization enhanced by Intel® Virtualization Technology allows a platform to run multiple operating systems and applications in independent partitions. With virtualization, one computer system can function as multiple virtual systems. Configuration options: [Enabled] [Disabled]

CPU TM function [Enabled]

Enables or disables Intel® CPU Thermal Monitor (TM) function, a CPU overheating protection function. When enabled, the CPU core frequency and voltage are reduced when the CPU overheats. Configuration options: [Disabled] [Enabled]

Execute-Disable Bit Capability [Enabled]

Allows you to enable or disable the No-Execution Page Protection Technology. Setting this item to **[Disabled]** forces the XD feature flag to always return to zero (0). Configuration options: [Disabled] [Enabled]



The following item appears only when you installed an Intel® CPU that supports the Enhanced Intel® SpeedStep® Technology (EIST).

Intel(R) SpeedStep(TM) Tech [Enabled]

Allows you to use the Enhanced Intel® SpeedStep® Technology. When set to [Enabled], you can adjust the system power settings in the operating system to use the EIST feature. Set this item to [Disabled] if you do not want to use the EIST. Configuration options: [Enabled] [Disabled]

2.5.2 Chipset

The **Chipset** menu allows you to change the advanced chipset settings. Select an item then press <Enter> to display the submenu.

North Bridge Configuration

Memory Remap Feature [Enabled]

Allows you to enable or disable the remapping of the overlapped PCI memory above the total physical memory. Enable this option only when you install 64-bit operating system. Configuration options: [Disabled] [Enabled]

Initiate Graphic Adapter [PEG/PCI]

Allows you to decide which graphics controller to use as the primary boot device. Configuration options: [PCI/PEG] [PEG/PCI]

2.5.3 Onboard Devices Configuration

High Definition Audio [Enabled]

Allows you to enable or disable the high definition audio. Configuration options: [Enabled] [Disabled]

Front Panel Type [HD Audio]

Allows you to select the front panel type. If High Definition Audio Front Panel used, please set HD Audio mode. Configuration options: [AC97] [HD Audio]

JMB368 IDE [Enabled]

Allows you to enable or disable the JMB368 IDE controller. Configuration options: [Disabled] [Enabled]

JMB368 IDE BOOTROM [Enabled]

Allows you to enable or disable the JMB368 IDE Boot ROM. This item appears only when the JMB368 IDE item is set to Enabled. Configuration options: [Disabled] [Enabled]

Onboard PCIE GbE LAN [Enabled]

Allows you to enable or disable the onboard LAN controller. Configuration options: [Enabled] [Disabled]

LAN Option ROM [Disabled]

Allows you to enable or disable the boot ROM in the onboard LAN controller. This item appears only when the Onboard LAN item is set to Enabled. Configuration options: [Disabled] [Enabled]

Serial Port1 Address [3F8/IRQ4]

Allows you to select the Serial Port1 base address.

Configuration options: [Disabled] [3F8/IRQ4] [2F8/IRQ3] [3E8/IRQ4] [2E8/IRQ3]

Parallel Port Address [378]

Allows you to select the Parallel Port base addresses. Configuration options: [Disabled] [378] [278] [3BC]

Parallel Port Mode [ECP]

Allows you to select the Parallel Port mode.

Configuration options: [Normal] [Bi-Directional] [EPP] [ECP]

ECP Mode DMA Channel [DMA3]

Appears only when the Parallel Port Mode is set to [ECP]. This item allows you to set the Parallel Port ECP DMA. Configuration options: [DMA0] [DMA1] [DMA3]

Parallel Port IRQ [IRQ7]

Allows you to select parallel port IRQ. Configuration options: [IRQ5] [IRQ7]

2.5.4 USB Configuration

The items in this menu allows you to change the USB-related features. Select an item then press **<Enter>** to display the configuration options.



The Module Version and USB Devices Enabled items show the auto-detected values. If no USB device is detected, the item shows **None**.

USB Functions [Enabled]

Allows you to disable or enable the USB functions. Configuration options: [Disabled] [Enabled]

USB 2.0 Controller [Enabled]

Allows you to enable or disable USB 2.0 controller.

Configuration options: [Enabled] [Disabled]

USB 2.0 Controller Mode [HiSpeed]

Allows you to configure the USB 2.0 controller in HiSpeed (480Mbps) or Full Speed (12Mbps). Configuration options: [FullSpeed] [HiSpeed]

Legacy USB Support [Auto]

Allows you to enable or disable support for Legacy USB storage devices, including USB flash drives and USB hard drives. Setting to **[Auto]** allows the system to detect the presence of USB devices at startup. If detected, the USB controller legacy mode is enabled. If no USB device is detected, the legacy USB support is disabled. Configuration options: [Disabled] [Enabled] [Auto]



The following items may only appear when a USB storage device is plugged.

USB Mass Storage Device Configuration

USB Mass Storage Reset Delay [20 Sec]

Allows you to set the maximum time that the BIOS waits for the USB storage device to initialize. Configuration options: [10 Sec] [20 Sec] [30 Sec] [40 Sec]

Emulation Type [Auto]

Allows you to set the emulation type. Configuration options: [Auto] [Floppy] [Forced FDD] [Hard Disk] [CDROM]

2.5.5 PCI PnP

The PCI PnP menu items allow you to change the advanced settings for PCI/PnP devices. The menu includes setting IRQ and DMA channel resources for either PCI/PnP or legacy ISA devices, and setting the memory size block for legacy ISA devices.



Take caution when changing the settings of the PCI PnP menu items. Incorrect field values can cause the system to malfunction.

Plug and Play O/S [No]

When set to [No], BIOS configures all the devices in the system. When set to [Yes] and if you install a Plug and Play operating system, the operating system configures the Plug and Play devices not required for boot. Configuration options: [No] [Yes]

2.6 Power menu

The Power menu items allow you to change the settings for the Advanced Power Management (APM). Select an item then press **<Enter>** to display the configuration options.

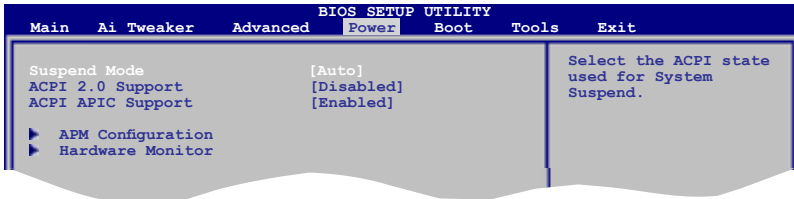

2.6.1 Suspend Mode [Auto]

Allows you to select the Advanced Configuration and Power Interface (ACPI) state to be used for system suspend. Configuration options: [S1 (POS) Only] [S3 Only] [Auto]

[S1(POS) Only] - Enables the system to enter the ACPI S1 (Power on Suspend) sleep state. In S1 sleep state, the system appears suspended and stays in a low power mode. The system can be resumed at any time.

[S3 Only] - Enables the system to enter the ACPI S3 (Suspend to RAM) sleep state (default). In S3 sleep state, the system appears to be off and consumes less power than in the S1 state. When signaled by a wake-up device or event, the system resumes to its working state exactly where it was left off.

[Auto] - Detected by OS.

2.6.2 ACPI 2.0 Support [Disabled]

Allows you to add more tables for Advanced Configuration and Power Interface (ACPI) 2.0 specifications. Configuration options: [Disabled] [Enabled]

2.6.3 ACPI APIC Support [Enabled]

Allows you to enable or disable the Advanced Configuration and Power Interface (ACPI) support in the Application-Specific Integrated Circuit (ASIC). When set to Enabled, the ACPI APIC table pointer is included in the RSDT pointer list. Configuration options: [Disabled] [Enabled]

2.6.4 APM Configuration

Restore on AC Power Loss [Power Off]

When set to **[Power Off]**, the system goes into off state after an AC power loss. When set to **[Power On]**, the system goes on after an AC power loss. When set to **[Last State]**, the system goes into either off or on state, whatever the system state was before the AC power loss. Configuration options: [Power Off] [Power On] [Last State]

Power On By RTC Alarm [Disabled]

Allows you to enable or disable RTC to generate a wake event. When this item is set to Enabled, the items RTC Alarm Date, RTC Alarm Hour, RTC Alarm Minute, and RTC Alarm Second appear with set values. Configuration options: [Disabled] [Enabled]

Power On By External Modems [Disabled]

This allows either settings of [Enabled] or [Disabled] for powering up the computer when the external modem receives a call while the computer is in Soft-off mode. Configuration options: [Disabled] [Enabled]

Power On By PCI Devices [Disabled]

When set to [Enabled], this parameter allows you to wake the system through a PCI LAN or modem card. This feature requires an ATX power supply that provides at least 1A on the +5VSB lead. Configuration options: [Disabled] [Enabled]

Power On By PCIE Devices [Disabled]

When set to [Enabled], this parameter allows you to wake the system through a PCI Express card. This feature requires an ATX power supply that provides at least 1A on the +5VSB lead. Configuration options: [Disabled] [Enabled]

Power On By PS/2 Keyboard [Disabled]

Allows you to use specific keys on the keyboard to turn on the system. This feature requires an ATX power supply that provides at least 1A on the +5VSB lead. Configuration options: [Disabled] [Space Bar] [Ctrl-Esc] [Power Key]

Power On By PS/2 Mouse [Disabled]

When set to [Enabled], this parameter allows you to use the PS/2 mouse to turn on the system. This feature requires an ATX power supply that provides at least 1A on the +5VSB lead. Configuration options: [Disabled] [Enabled]

2.6.5 Hardware Monitor

CPU Temperature [xxx°C/xxx°F] or [Ignored]

MB Temperature [xxx°C/xxx°F] or [Ignored]

The onboard hardware monitor automatically detects and displays the motherboard and CPU temperatures. Select **Ignored** if you do not wish to display the detected temperatures.

CPU Fan Speed [xxxxRPM] or [Ignored]

The onboard hardware monitor automatically detects and displays the CPU fan speed in rotations per minute (RPM). If the fan is not connected to the motherboard, the field shows **N/A**. Select **Ignored** if you do not wish to display the detected speed.

CPU Q-Fan Control [Disabled]

Allows you to enable or disable the CPU Q-Fan control. Configuration options: [Disabled] [Enabled]

Chassis Fan Speed [Ignored] or [N/A]

The onboard hardware monitor automatically detects and displays the Chassis fan speed in rotations per minute (RPM). If the fan is not connected to the motherboard, the field shows **N/A**. Select **Ignored** if you do not wish to display the detected speed.

VCORE Voltage, 3.3V Voltage, 5V Voltage, 12V Voltage [xxxV] or [Ignored]

The onboard hardware monitor automatically detects the voltage output through the onboard voltage regulators.

2.7 Boot menu

The **Boot** menu items allow you to change the system boot options. Select an item then press **<Enter>** to display the sub-menu.

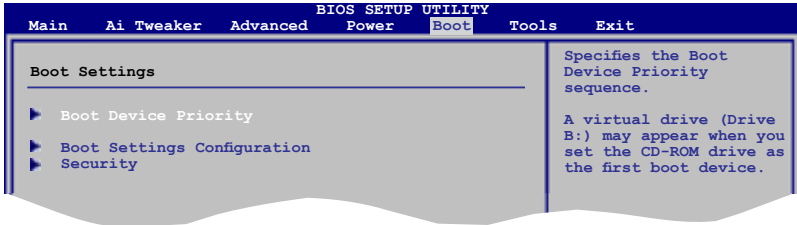

2.7.1 Boot Device Priority

1st ~ xxth Boot Device

These items specify the boot device priority sequence from the available devices. The number of device items that appears on the screen depends on the number of devices installed in the system. Configuration options: [Removable Dev] [Hard Drive] [ATAPI CD-ROM] [Disabled]

2.7.2 Boot Settings Configuration

Quick Boot [Enabled]

Enabling this item allows the BIOS to skip some power on self tests (POST) while booting to decrease the time needed to boot the system. When set to **[Disabled]**, BIOS performs all the POST items. Configuration options: [Disabled] [Enabled]

Full Screen Logo [Enabled]

This allows you to enable or disable the full screen logo display feature. Configuration options: [Disabled] [Enabled]



Set this item to **[Enabled]** to use the ASUS MyLogo2™ feature.

AddOn ROM Display Mode [Force BIOS]

Sets the display mode for option ROM. Configuration options: [Force BIOS] [Keep Current]

Bootup Num-Lock [On]

Allows you to select the power-on state for the NumLock. Configuration options: [Off] [On]

Wait For 'F1' If Error [Enabled]

When set to **Enabled**, the system waits for the F1 key to be pressed when error occurs.
Configuration options: [Disabled] [Enabled]

Hit 'DEL' Message Display [Enabled]

When set to **[Enabled]**, the system displays the message **Press DEL to run Setup** during POST. Configuration options: [Disabled] [Enabled]

2.7.3 Security

The **Security** menu items allow you to change the system security settings. Select an item then press **<Enter>** to display the configuration options.

Change Supervisor Password

Select this item to set or change the supervisor password. The **Supervisor Password** item on top of the screen shows the default **Not Installed**. After you set a password, this item shows **Installed**.

To set a Supervisor Password:

1. Select the **Change Supervisor Password** item and press **<Enter>**.
2. On the password box, key in a password containing up to six letters, or numbers, or both, then press **<Enter>**.
3. Confirm the password when prompted.

The message **Password Installed** appears after you successfully set your password.

To change the supervisor password, follow the same steps in setting a supervisor password.

To clear the supervisor password, select the **Change Supervisor Password** then press **<Enter>** twice. The message **Password uninstalled** appears.



If you forget your BIOS password, you can clear it by erasing the CMOS Real Time Clock (RTC) RAM. See section 1.9 **Jumpers** for information on how to erase the RTC RAM.

After you have set a supervisor password, the other items appear to allow you to change other security settings.

User Access Level [Full Access]

This item allows you to select the access restriction to the Setup items.

Configuration options: [No Access] [View Only] [Limited] [Full Access]

[No Access] - prevents user access to the Setup utility.

[View Only] - allows access but does not allow change to any field.

[Limited] - allows changes only to selected fields, such as Date and Time.

[Full Access] - allows viewing and changing all the fields in the Setup utility.

Change User Password

Select this item to set or change the user password. The **User Password** item on top of the screen shows the default **Not Installed**. After you set a password, this item shows **Installed**.

To set a User Password:

1. Select the **Change User Password** item and press **<Enter>**.
2. On the password box, key in a password containing up to six letters, or numbers, or both, then press **<Enter>**.
3. Confirm the password when prompted.

The message **Password Installed** appears after you set your password successfully.

To change the user password, follow the same steps in setting a user password.

Clear User Password

Select this item to clear the user password.

Password Check [Setup]

When set to **[Setup]**, BIOS checks for user password when accessing the Setup utility. When set to **[Always]**, BIOS checks for user password both when accessing Setup and booting the system. Configuration options: [Setup] [Always]

2.8 Tools menu

The Tools menu items allow you to configure options for special functions. Select an item then press **<Enter>** to display the sub-menu.

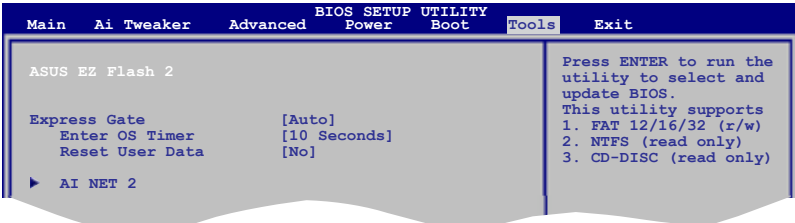

2.8.1 ASUS EZ Flash 2

Allows you to run ASUS EZ Flash 2. When you press **<Enter>**, a confirmation message appears. Use the left/right arrow key to select between **[Yes]** or **[No]**, then press **<Enter>** to confirm your choice. Please see section 2.1.2 for details.

2.8.2 Express Gate [Auto]

Allows you to enable or disable the ASUS Express Gate feature. The ASUS Express Gate feature is a unique instant-on environment that provides quick access to the Internet browser and Skype. Configuration options: [Enabled] [Disabled] [Auto]

Enter OS Timer [10 Seconds]

Sets countdown duration that the system waits at the Express Gate's first screen before starting Windows or other installed OS. Choose **[Prompt User]** to stay at the first screen of Express Gate for user action.

Configuration options: [Prompt User] [1 second] [3 seconds] [5 seconds] [10 seconds] [15 seconds] [20 seconds] [30 seconds]

Reset User Data [No]

Allows you to clear Express Gate's user data.

Configuration options: [No] [Reset]

When setting this item to **[Reset]**, make sure to save the setting to the BIOS so that the user data will be cleared the next time you enter the Express Gate. User data includes the Express Gate's settings as well as any personal information stored by the web browser (bookmarks, cookies, browsing history, etc.). This is useful in the rare case where corrupt settings prevent the Express Gate environment from launching properly.



The first time wizard will run again when you enter the Express Gate environment after clearing its settings.

2.8.3 AI NET 2

Check Atheros LAN cable [Disabled]

Enables or disables checking of the Atheros LAN cable during the Power-On Self-Test (POST). Configuration options: [Disabled] [Enabled]

2.9 Exit menu

The Exit menu items allow you to load the optimal or failsafe default values for the BIOS items, and save or discard your changes to the BIOS items.

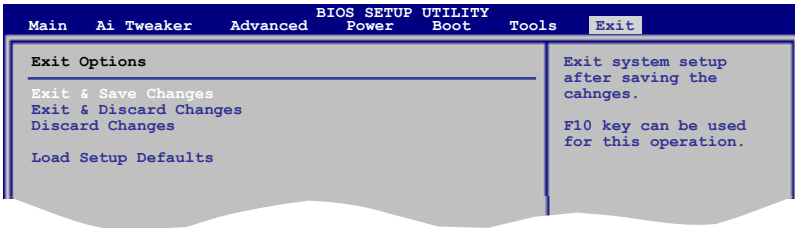

Pressing **<Esc>** does not immediately exit this menu. Select one of the options from this menu or **<F10>** from the legend bar to exit.

Exit & Save Changes

Once you are finished making your selections, choose this option from the Exit menu to ensure the values you selected are saved to the CMOS RAM. An onboard backup battery sustains the CMOS RAM so it stays on even when the PC is turned off. When you select this option, a confirmation window appears. Select **OK** to save changes and exit.

Exit & Discard Changes

Select this option only if you do not want to save the changes that you made to the Setup program. If you made changes to fields other than System Date, System Time, and Password, the BIOS asks for a confirmation before exiting.

Discard Changes

This option allows you to discard the selections you made and restore the previously saved values. After selecting this option, a confirmation appears. Select **OK** to discard any changes and load the previously saved values.

Load Setup Defaults

This option allows you to load the default values for each of the parameters on the Setup menus. When you select this option or if you press **<F5>**, a confirmation window appears. Select **OK** to load default values. Select **Exit & Save Changes** or make other changes before saving the values to the non-volatile RAM.