

P5QL PRO

ASUS[®]

Motherboard

E3782

First Edition V1

May 2008

Copyright © 2008 ASUSTeK COMPUTER INC. All Rights Reserved.

No part of this manual, including the products and software described in it, may be reproduced, transmitted, transcribed, stored in a retrieval system, or translated into any language in any form or by any means, except documentation kept by the purchaser for backup purposes, without the express written permission of ASUSTeK COMPUTER INC. ("ASUS").

Product warranty or service will not be extended if: (1) the product is repaired, modified or altered, unless such repair, modification or alteration is authorized in writing by ASUS; or (2) the serial number of the product is defaced or missing.

ASUS PROVIDES THIS MANUAL "AS IS" WITHOUT WARRANTY OF ANY KIND, EITHER EXPRESS OR IMPLIED, INCLUDING BUT NOT LIMITED TO THE IMPLIED WARRANTIES OR CONDITIONS OF MERCHANTABILITY OR FITNESS FOR A PARTICULAR PURPOSE. IN NO EVENT SHALL ASUS, ITS DIRECTORS, OFFICERS, EMPLOYEES OR AGENTS BE LIABLE FOR ANY INDIRECT, SPECIAL, INCIDENTAL, OR CONSEQUENTIAL DAMAGES (INCLUDING DAMAGES FOR LOSS OF PROFITS, LOSS OF BUSINESS, LOSS OF USE OR DATA, INTERRUPTION OF BUSINESS AND THE LIKE), EVEN IF ASUS HAS BEEN ADVISED OF THE POSSIBILITY OF SUCH DAMAGES ARISING FROM ANY DEFECT OR ERROR IN THIS MANUAL OR PRODUCT.

SPECIFICATIONS AND INFORMATION CONTAINED IN THIS MANUAL ARE FURNISHED FOR INFORMATIONAL USE ONLY, AND ARE SUBJECT TO CHANGE AT ANY TIME WITHOUT NOTICE, AND SHOULD NOT BE CONSTRUED AS A COMMITMENT BY ASUS. ASUS ASSUMES NO RESPONSIBILITY OR LIABILITY FOR ANY ERRORS OR INACCURACIES THAT MAY APPEAR IN THIS MANUAL, INCLUDING THE PRODUCTS AND SOFTWARE DESCRIBED IN IT.

Products and corporate names appearing in this manual may or may not be registered trademarks or copyrights of their respective companies, and are used only for identification or explanation and to the owners' benefit, without intent to infringe.

Contents

Notices.....	vii
Safety information	viii
About this guide	ix
P5QL PRO specifications summary.....	xi

Chapter 1: Product introduction

1.1	Welcome!	1-1
1.2	Package contents.....	1-1
1.3	Special features.....	1-2
1.3.1	Product highlights	1-2
1.3.2	ASUS unique features	1-3
1.3.3	ASUS Stylish features.....	1-6
1.3.4	ASUS Intelligent Overclocking features	1-6

Chapter 2: Hardware information

2.1	Before you proceed	2-1
2.2	Motherboard overview	2-2
2.2.1	Placement direction	2-2
2.2.2	Screw holes	2-2
2.2.3	Motherboard layout	2-3
2.2.4	Layout contents.....	2-4
2.3	Central Processing Unit (CPU)	2-6
2.3.1	Installing the CPU	2-7
2.3.2	Installing the CPU heatsink and fan	2-10
2.3.3	Uninstalling the CPU heatsink and fan	2-11
2.4	System memory	2-12
2.4.1	Overview	2-12
2.4.2	Memory configurations.....	2-12
2.4.3	Installing a DIMM	2-17
2.4.4	Removing a DIMM	2-17
2.5	Expansion slots.....	2-18
2.5.1	Installing an expansion card	2-18
2.5.2	Configuring an expansion card	2-18
2.5.3	Interrupt assignments	2-19
2.5.4	PCI slots.....	2-20
2.5.5	PCI Express x1 slots.....	2-20
2.5.6	PCI Express x16 slot.....	2-20

Contents

2.6	Jumpers	2-21
2.7	Connectors	2-23
2.7.1	Rear panel connectors	2-23
2.7.2	Internal connectors	2-25
Chapter 3: Powering up		
3.1	Starting up for the first time	3-1
3.2	Turning off the computer	3-2
3.2.1	Using the OS shut down function.....	3-2
3.2.2	Using the dual function power switch.....	3-2
Chapter 4: BIOS setup		
4.1	Managing and updating your BIOS	4-1
4.1.1	ASUS Update utility	4-1
4.1.2	Creating a bootable floppy disk.....	4-4
4.1.3	ASUS EZ Flash 2 utility.....	4-5
4.1.4	AFUDOS utility.....	4-6
4.1.5	ASUS CrashFree BIOS 3 utility	4-8
4.2	BIOS setup program	4-10
4.2.1	BIOS menu screen.....	4-11
4.2.2	Menu bar.....	4-11
4.2.3	Navigation keys.....	4-11
4.2.4	Menu items	4-12
4.2.5	Sub-menu items.....	4-12
4.2.6	Configuration fields	4-12
4.2.7	Pop-up window	4-12
4.2.8	Scroll bar.....	4-12
4.2.9	General help	4-12
4.3	Main menu	4-13
4.3.1	System Time	4-13
4.3.2	System Date	4-13
4.3.3	Legacy Diskette A	4-13
4.3.4	SATA 1~6.....	4-14
4.3.5	Storage Configuration	4-15
4.3.6	System Information	4-16
4.4	Ai Tweaker menu	4-17

Contents

4.5	Advanced menu	4-22
4.5.1	CPU Configuration	4-23
4.5.2	Chipset	4-24
4.5.3	Onboard Devices Configuration	4-25
4.5.4	USB Configuration	4-26
4.5.5	PCI PnP	4-27
4.6	Power menu.....	4-28
4.6.1	Suspend Mode	4-28
4.6.2	ACPI 2.0 Support	4-28
4.6.3	ACPI APIC Support.....	4-28
4.6.4	APM Configuration.....	4-29
4.6.5	Hardware Monitor	4-30
4.7	Boot menu	4-31
4.7.1	Boot Device Priority	4-32
4.7.2	Boot Settings Configuration	4-33
4.7.3	Security	4-34
4.8	Tools menu	4-36
4.8.1	ASUS EZ Flash 2.....	4-37
4.8.2	Express Gate	4-37
4.8.3	AI NET 2.....	4-38
4.8.4	ASUS O.C. Profile.....	4-38
4.9	Exit menu	4-40
 Chapter 5: Software support		
5.1	Installing an operating system	5-1
5.2	Support DVD information	5-1
5.2.1	Running the support DVD	5-1
5.2.2	Drivers menu	5-2
5.2.3	Utilities menu	5-3
5.2.4	Manual menu	5-5
5.2.5	ASUS Contact information	5-6
5.2.6	Other information	5-7
5.3	Software information	5-10
5.3.1	ASUS MyLogo2™	5-10
5.3.2	Audio configurations	5-12
5.3.3	ASUS PC Probe II.....	5-16

Contents

5.3.4	ASUS AI Suite.....	5-22
5.3.5	ASUS AI Booster.....	5-24
5.3.6	ASUS AI Nap	5-25
5.3.7	ASUS Fan Xpert	5-26
5.3.8	ASUS EPU-4 Engine	5-27
5.3.9	ASUS Express Gate	5-31

Appendix: CPU features

A.1	Intel® EM64T.....	A-1
	Using the Intel® EM64T feature.....	A-1
A.2	Enhanced Intel SpeedStep® Technology (EIST).....	A-1
A.2.1	System requirements.....	A-1
A.2.2	Using the EIST.....	A-2
A.3	Intel® Hyper-Threading Technology	A-3
	Using the Hyper-Threading Technology	A-3

Notices

Federal Communications Commission Statement

This device complies with Part 15 of the FCC Rules. Operation is subject to the following two conditions:

- This device may not cause harmful interference, and
- This device must accept any interference received including interference that may cause undesired operation.

This equipment has been tested and found to comply with the limits for a Class B digital device, pursuant to Part 15 of the FCC Rules. These limits are designed to provide reasonable protection against harmful interference in a residential installation. This equipment generates, uses and can radiate radio frequency energy and, if not installed and used in accordance with manufacturer's instructions, may cause harmful interference to radio communications. However, there is no guarantee that interference will not occur in a particular installation. If this equipment does cause harmful interference to radio or television reception, which can be determined by turning the equipment off and on, the user is encouraged to try to correct the interference by one or more of the following measures:

- Reorient or relocate the receiving antenna.
- Increase the separation between the equipment and receiver.
- Connect the equipment to an outlet on a circuit different from that to which the receiver is connected.
- Consult the dealer or an experienced radio/TV technician for help.



The use of shielded cables for connection of the monitor to the graphics card is required to assure compliance with FCC regulations. Changes or modifications to this unit not expressly approved by the party responsible for compliance could void the user's authority to operate this equipment.

Canadian Department of Communications Statement

This digital apparatus does not exceed the Class B limits for radio noise emissions from digital apparatus set out in the Radio Interference Regulations of the Canadian Department of Communications.

This class B digital apparatus complies with Canadian ICES-003.

Safety information

Electrical safety

- To prevent electrical shock hazard, disconnect the power cable from the electrical outlet before relocating the system.
- When adding or removing devices to or from the system, ensure that the power cables for the devices are unplugged before the signal cables are connected. If possible, disconnect all power cables from the existing system before you add a device.
- Before connecting or removing signal cables from the motherboard, ensure that all power cables are unplugged.
- Seek professional assistance before using an adapter or extension cord. These devices could interrupt the grounding circuit.
- Make sure that your power supply is set to the correct voltage in your area. If you are not sure about the voltage of the electrical outlet you are using, contact your local power company.
- If the power supply is broken, do not try to fix it by yourself. Contact a qualified service technician or your retailer.

Operation safety

- Before installing the motherboard and adding devices on it, carefully read all the manuals that came with the package.
- Before using the product, make sure all cables are correctly connected and the power cables are not damaged. If you detect any damage, contact your dealer immediately.
- To avoid short circuits, keep paper clips, screws, and staples away from connectors, slots, sockets and circuitry.
- Avoid dust, humidity, and temperature extremes. Do not place the product in any area where it may become wet.
- Place the product on a stable surface.
- If you encounter technical problems with the product, contact a qualified service technician or your retailer.



This symbol of the crossed out wheeled bin indicates that the product (electrical and electronic equipment) should not be placed in municipal waste. Check local regulations for disposal of electronic products.

About this guide

This user guide contains the information you need when installing and configuring the motherboard.

How this guide is organized

This guide contains the following parts:

- **Chapter 1: Product introduction**
This chapter describes the features of the motherboard and the new technology it supports.
- **Chapter 2: Hardware information**
This chapter lists the hardware setup procedures that you have to perform when installing system components. It includes description of the switches, jumpers, and connectors on the motherboard.
- **Chapter 3: Powering up**
This chapter describes the power up sequence and ways of shutting down the system.
- **Chapter 4: BIOS setup**
This chapter tells how to change system settings through the BIOS Setup menus. Detailed descriptions of the BIOS parameters are also provided.
- **Chapter 5: Software support**
This chapter describes the contents of the support CD that comes with the motherboard package.
- **Appendix: CPU features**
The Appendix describes the CPU features and technologies that the motherboard supports.

Where to find more information

Refer to the following sources for additional information and for product and software updates.

1. **ASUS websites**
The ASUS website provides updated information on ASUS hardware and software products. Refer to the ASUS contact information.
2. **Optional documentation**
Your product package may include optional documentation, such as warranty flyers, that may have been added by your dealer. These documents are not part of the standard package.

Conventions used in this guide

To make sure that you perform certain tasks properly, take note of the following symbols used throughout this manual.



DANGER/WARNING: Information to prevent injury to yourself when trying to complete a task.



CAUTION: Information to prevent damage to the components when trying to complete a task.



IMPORTANT: Instructions that you **MUST** follow to complete a task.



NOTE: Tips and additional information to help you complete a task.

Typography

Bold text

Indicates a menu or an item to select.

Italics

Used to emphasize a word or a phrase.

<Key>

Keys enclosed in the less-than and greater-than sign means that you must press the enclosed key.

Example: <Enter> means that you must press the Enter or Return key.

<Key1>+<Key2>+<Key3>

If you must press two or more keys simultaneously, the key names are linked with a plus sign (+).

Example: <Ctrl>+<Alt>+<D>

Command

Means that you must type the command exactly as shown, then supply the required item or value enclosed in brackets.

Example: At the DOS prompt, type the command line:

```
a.fudos /i [filename]
```

```
a.fudos /iP5QLPRO.ROM
```

P5QL PRO specifications summary

CPU	LGA775 socket for Intel® Core™2 Extreme / Core™2 Quad / Core™2 Duo / Pentium® Dual-Core / Celeron® Dual-Core / Celeron® processors Compatible with Intel® 05B/05A/06 processors Supports Intel® next-generation 45nm multi-core CPU
Chipset	Intel® P43 / ICH10 with Intel® Fast Memory Access Technology
System Bus	1600(O.C.)*/1333/1066/800 MHz
Memory	Dual-channel memory architecture <ul style="list-style-type: none"> - 4 x 240-pin DIMM sockets support unbuffered non-ECC DDR2 1066/800/667MHz memory modules - Supports up to 16GB system memory Refer to www.asus.com or this user manual for the Memory QVL (Qualified Vendors Lists) * When you install a total memory of 4GB or more, Windows® 32-bit operation system may only recognize less than 3GB. Hence, a maximum of 3GB system memory is recommended if you are using a Windows 32-bit operation system.
Expansion Slots	1 x PCI Express™ x16 slot 2 x PCI Express x1 slots 3 x PCI slots
Storage	Intel ICH10 southbridge supports: <ul style="list-style-type: none"> - 6 x Serial ATA 3.0Gb/s ports Marvell® 88SE6102 PATA controller supports: <ul style="list-style-type: none"> - 1 x UltraDMA 133/100/66 for up to 2 PATA devices
LAN	PCIe Gigabit LAN controller featuring AI NET2
Audio	Realtek® ALC1200 8-channel High-Definition Audio CODEC <ul style="list-style-type: none"> - Supports Jack-detect and Multi-streaming - Coaxial S/PDIF out ports at back I/O - ASUS Noise Filter
USB	12 x USB 2.0 ports (6 at mid-board, 6 at back panel)
ASUS Unique Features	ASUS Power Saving Solution: <ul style="list-style-type: none"> - ASUS EPU-4 Engine - ASUS AI Nap ASUS AI Life Features: <ul style="list-style-type: none"> - ASUS Express Gate ASUS Crystal Sound: <ul style="list-style-type: none"> - ASUS Noise Filter ASUS EZ DIY: <ul style="list-style-type: none"> - ASUS Q-Connector - ASUS O.C. Profile - ASUS CrashFree BIOS 3 - ASUS EZ Flash 2

(continued on the next page)

P5QL PRO specifications summary

ASUS Exclusive Overclocking Features	<p>Intelligent overclocking tools:</p> <ul style="list-style-type: none"> - ASUS AI Booster utility <p>Precision Tweaker:</p> <ul style="list-style-type: none"> - vCore: Adjustable CPU voltage at 0.00625V increment - vDIMM: 17-step DRAM voltage control <p>SFS (Stepless Frequency Selection):</p> <ul style="list-style-type: none"> - FSB tuning from 200MHz to 800 MHz at 1MHz increment - Memory tuning from 667MHz to 1333MHz for DDR2 - PCI Express frequency tuning from 100MHz to 180MHz at 1MHz increment <p>Overclocking protection:</p> <ul style="list-style-type: none"> - ASUS C.P.R. (CPU Parameter Recall)
Other Features	ASUS MyLogo2
Rear Panel Connectors	<p>1 x PS/2 keyboard port 1 x PS/2 mouse port 1 x Coaxial S/PDIF Out port 1 x LAN (RJ-45) port 6 x USB 2.0/1.1 ports 8-channel audio I/O ports</p>
Internal Connectors	<p>3 x USB connectors support 6 additional USB ports 1 x Floppy disk drive connector 1 x IDE connector 6 x Serial ATA connectors 1 x CPU / 1 x Chassis / 1 x Power fan connectors 1 x COM connector 1 x S/PDIF Out header 1 x Chassis intrusion connector Front panel audio connector 1 x CD audio in connector 1 x 24-pin ATX power connector 1 x 4-pin ATX 12V power connector System panel connector (Q-Connector)</p>
BIOS Features	8Mb Flash ROM, AMI BIOS, PnP, DMI 2.0, WfM 2.0, SM BIOS 2.3, ACPI 2.0a, ASUS EZ Flash 2, ASUS CrashFree BIOS 3
Manageability	WfM 2.0, DMI 2.0, WOL by PME, WOR by PME, PXE
Support DVD	<p>Drivers ASUS PC Probe II ASUS Update ASUS AI Suite Anti-Virus software (OEM version)</p>
Form factor	ATX form factor: 12 in x 7.6 in (30.5 cm x 19.3 cm)

*Specifications are subject to change without notice.

This chapter describes the motherboard features and the new technologies it supports.

1 Product introduction

Chapter summary



1.1	Welcome!	1-1
1.2	Package contents.....	1-1
1.3	Special features.....	1-2

1.1 Welcome!

Thank you for buying an ASUS® P5QL PRO motherboard!

The motherboard delivers a host of new features and latest technologies, making it another standout in the long line of ASUS quality motherboards!

Before you start installing the motherboard, and hardware devices on it, check the items in your package with the list below.

1.2 Package contents

Check your motherboard package for the following items.

Motherboard	ASUS P5QL PRO motherboard
Cables	2 x Serial ATA signal cables 1 x Serial ATA power cable 1 x Ultra DMA 133/100/66 cable 1 x Floppy disk drive cable
Accessories	1 x I/O shield 2 in 1 Q-Connector
Application CD	ASUS motherboard support DVD
Documentation	User guide



If any of the above items is damaged or missing, contact your retailer.

1.3 Special features

1.3.1 Product highlights

Green ASUS

This motherboard and its packaging comply with the European Union's Restriction on the use of Hazardous Substances (RoHS). This is in line with the ASUS vision of creating environment-friendly and recyclable products/packaging to safeguard consumers' health while minimizing the impact on the environment.

Intel® Core™2 Extreme / Core™2 Quad / Core™2 Duo CPU support



This motherboard supports the latest Intel® Core™2 processor in the LGA775 package and Intel® next-generation 45nm multi-core processors. With the new Intel® Core™ microarchitecture technology and 1333/1066/800 MHz FSB, the Intel® Core™2 processor is one of the most powerful and energy efficient CPU in the world. See page 2-6 for details.

Intel® P43 Chipset

The Intel® P43 Express Chipset is designed to support dual-channel DDR2 1066/800/667MHz architecture, 1333/1066/800 FSB (Front Side Bus), PCIe 2.0, and multi-core CPUs. It supports Intel Fast Memory Access technology that significantly optimizes the use of available memory bandwidth and reduces the latency of the memory accesses.



PCI Express 2.0 support

This motherboard supports the latest PCIe 2.0 devices for double speed and bandwidth which enhances system performance.



FSB 1600 support (O.C.)

ASUS's exclusive overclocking design now unleashes the ultimate potential of the Intel® Core™2 processor. With the new Intel 45nm micro-architecture technology and FSB 1600 (O.C.) / 1333 / 1066 / 800 MHz, this motherboard allows you to enjoy the latest technology supported by one of the most powerful and energy efficient CPUs in the world.

Serial ATA 3Gb/s technology



This motherboard supports the next-generation hard drives based on the Serial ATA (SATA) 3Gb/s storage specification, delivering enhanced scalability and doubling the bus bandwidth for high-speed data retrieval and saves.

1.3.2 ASUS unique features

ASUS AI Life Features



Taking only 5 seconds to go online from bootup, Express Gate is the one-stop gateway to instant fun! It's a unique motherboard built-in OS. You can utilize the most popular Instant Messengers (IM) like MSN, Skype, Google talk, QQ, and Yahoo! Messenger to keep in touch with friends, or quickly check on the weather and e-mails just before leaving your house. What's more, the user-friendly picture manager lets you view your pictures without entering Windows at anytime!



- The actual boot time depends on the system configuration.
- ASUS Express Gate supports file uploading from SATA HDDs, ODDs and USB drives and downloading to USB drives only.

ASUS Power Saving Solution

ASUS Power Saving solution intelligently and automatically provides balanced computing power and energy consumption.



ASUS EPU-4 Engine

The new ASUS EPU - the world's first power saving engine, has been upgraded to a new four-engine version, which provides total system power savings by detecting current PC loadings and intelligently moderating power in real-time. The EPU automatically provides the most appropriate power usage for the CPU, VGA card, hard drives, and CPU cooler fan - helping save power and money.

AI Nap



With AI Nap, users can instantly snooze your PC without terminating the tasks. The system will continue operating at minimum power and noise when user is temporarily away. It keeps downloading files or running applications in quietest state while you are sleeping. Simply click keyboard or mouse, you can swiftly wake up the system in a few seconds.

ASUS Quiet Thermal Solution

ASUS Quiet Thermal solution makes system more stable and enhances the overclocking capability.

Fan Xpert



ASUS Fan Xpert intelligently allows users to adjust the CPU fan speed according to different ambient temperature, which is caused by different climate conditions in different geographic regions and system loading. Built-in variety of useful profiles offer flexible controls of fan speed to achieve a quiet and cool environment.

ASUS Crystal Sound

This feature can enhance speech-centric applications like Skype, online game, video conference and recording.

Noise Filter



This feature detects repetitive and stationary noises (non-voice signals) like computer fans, air conditioners, and other background noises then eliminates it in the incoming audio stream while recording.

ASUS EZ DIY

ASUS EZ DIY feature collection provides you with easy ways to install computer components, update the BIOS or back up your favorite settings.

ASUS Q-Connector



ASUS Q-Connector allows you to easily connect or disconnect the chassis front panel cables to the motherboard. This unique module eliminates the trouble of plugging in one cable one at a time, making connection quick and accurate.



ASUS O.C. Profile

The motherboard features the ASUS O.C. Profile that allows users to conveniently store or load multiple BIOS settings. The BIOS settings can be stored in the CMOS or a separate file, giving users freedom to share and distribute their favorite overclocking settings. See page 4-38 for details.



ASUS CrashFree BIOS 3

The ASUS CrashFree BIOS 3 allows users to restore corrupted BIOS data from a bootable floppy disk, a USB flash disk or the motherboard support DVD containing the BIOS file. See page 4-8 for details.



ASUS EZ Flash 2

EZ Flash 2 is a user-friendly BIOS update utility. Simply press the predefined hotkey to launch the utility and update the BIOS without entering the OS. Update your BIOS easily without preparing a bootable diskette or using an OS-based flash utility. See page 4-5 and 4-37 for details.

1.3.3 ASUS Stylish features



ASUS MyLogo2™

This feature allows you to convert your favorite photo into a 256-color boot logo for a more colorful and vivid image on your screen. See page 5-10 for details.

1.3.4 ASUS Intelligent Overclocking features

AI Booster

The ASUS AI Booster allows you to overclock the CPU speed in Windows environment without the hassle of booting the BIOS. See page 5-24 for details.



Precision Tweaker

This feature allows you to fine tune the CPU/memory voltage and gradually increase the memory Front Side Bus (FSB) and PCI Express frequency at 1MHz increment to achieve maximum system performance. See page 4-17 to 4-22 for details.

C.P.R. (CPU Parameter Recall)



The C.P.R. feature of the motherboard BIOS allows automatic re-setting to the BIOS default settings in case the system hangs due to overclocking failure. When the system hangs due to overclocking failure, C.P.R. eliminates the need to open the system chassis and clear the RTC data. Simply shut down and reboot the system, and the BIOS automatically restores the CPU default settings for each parameter.

This chapter lists the hardware setup procedures that you have to perform when installing system components. It includes description of the jumpers and connectors on the motherboard.

Hardware 2 information

2.1	Before you proceed	2-1
2.2	Motherboard overview.....	2-2
2.3	Central Processing Unit (CPU)	2-6
2.4	System memory	2-12
2.5	Expansion slots.....	2-18
2.6	Jumpers	2-21
2.7	Connectors	2-23

2.1 Before you proceed

Take note of the following precautions before you install motherboard components or change any motherboard settings.



- Unplug the power cord from the wall socket before touching any component.
- Use a grounded wrist strap or touch a safely grounded object or a metal object, such as the power supply case, before handling components to avoid damaging them due to static electricity.
- Hold components by the edges to avoid touching the ICs on them.
- Whenever you uninstall any component, place it on a grounded antistatic pad or in the bag that came with the component.
- Before you install or remove any component, ensure that the ATX power supply is switched off or the power cord is detached from the power supply. Failure to do so may cause severe damage to the motherboard, peripherals, and/or components.

Onboard LED

The motherboard comes with a standby power LED that lights up to indicate that the system is ON, in sleep mode, or in soft-off mode. This is a reminder that you should shut down the system and unplug the power cable before removing or plugging in any motherboard component. The illustration below shows the location of the onboard LED.

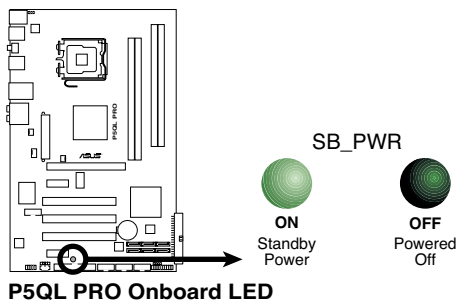

2.2 Motherboard overview

Before you install the motherboard, study the configuration of your chassis to ensure that the motherboard fits into it.



Ensure that you unplug the power cord before installing or removing the motherboard. Failure to do so can cause you physical injury and damage motherboard components.

2.2.1 Placement direction

When installing the motherboard, make sure that you place it into the chassis in the correct orientation. The edge with external ports goes to the rear part of the chassis as indicated in the image below.

2.2.2 Screw holes

Place six (6) screws into the holes indicated by circles to secure the motherboard to the chassis.



Do not overtighten the screws! Doing so can damage the motherboard.

Place this side towards
the rear of the chassis

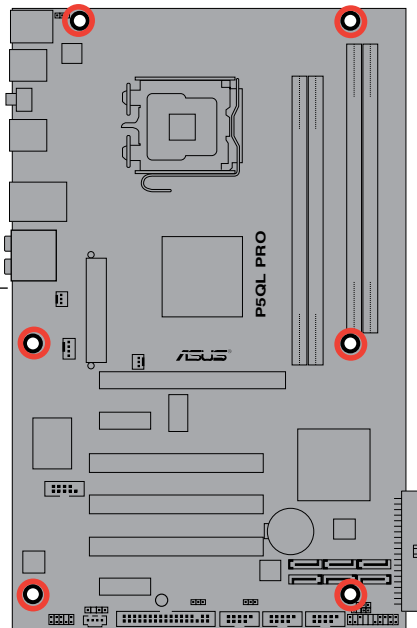

2.2.3 Motherboard layout

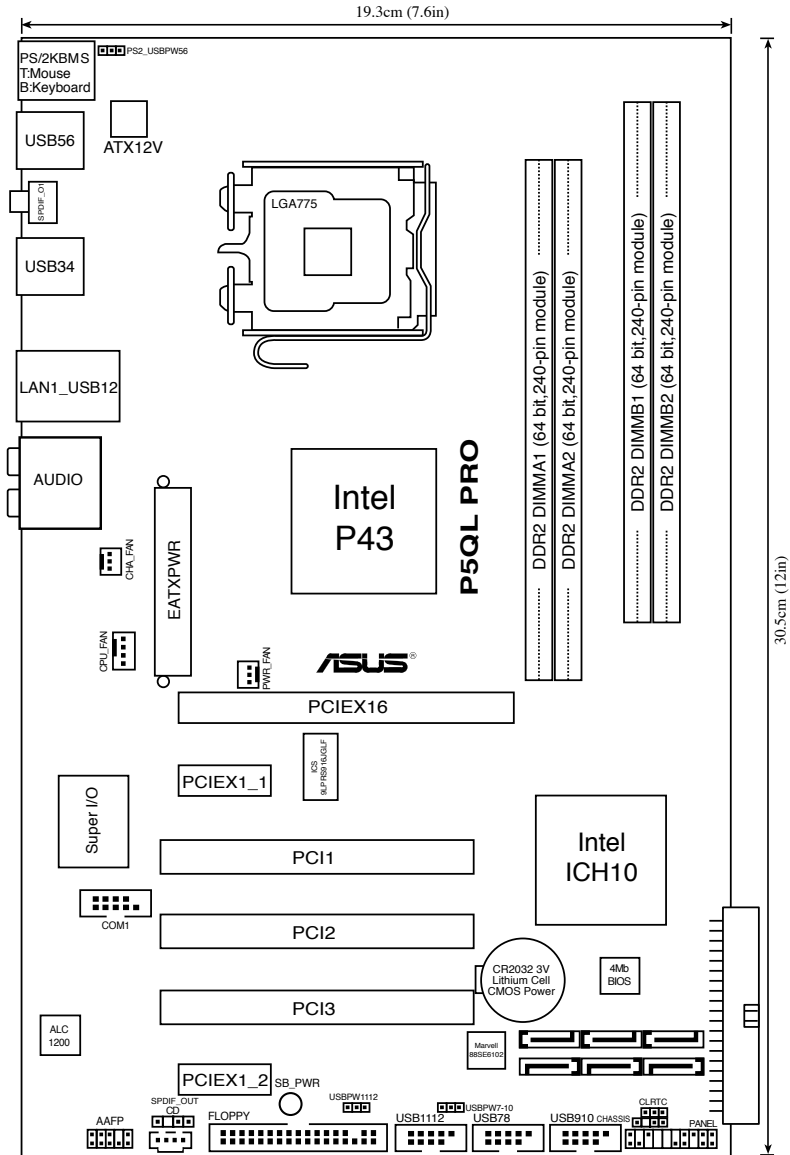

Refer to **2.7 Connectors** for more information about rear panel connectors and internal connectors.

2.2.4 Layout contents

Slots		Page
1.	DDR2 DIMM slots	2-12
2.	PCI slots	2-20
3	PCI Express x1 slot	2-20
4.	PCI Express x16 slots	2-20

Jumper		Page
1.	Clear RTC RAM (3-pin CLRRTC)	2-21
2.	Keyboard power (3-pin PS2_USBPW56)	2-22
3.	USB device wake-up (3-pin USBPW1-4, USBPW7-10, USBPW1112)	2-22

Rear panel connectors		Page
1.	PS/2 mouse port (green)	2-23
2.	LAN (RJ-45) port	2-23
3.	Rear Speaker Out port (black)	2-23
4.	Center/Subwoofer port (orange)	2-23
5.	Line In port (light blue)	2-23
6.	Line Out port (lime)	2-23
7.	Microphone port (pink)	2-24
8.	Side Speaker Out port (gray)	2-24
9.	USB 2.0 ports 1 and 2	2-24
10.	USB 2.0 ports 3 and 4	2-24
11.	Coaxial S/PDIF Out port	2-24
12.	USB 2.0 ports 5 and 6	2-24
13.	PS/2 keyboard port (purple)	2-24

Internal connectors		Page
1.	Floppy disk drive connector (34-1 pin FLOPPY)	2-25
2.	Digital audio connector (4-1 pin SPDIF_OUT)	2-25
3.	IDE connector (40-1 pin PRI_EIDE)	2-26
4.	Serial ATA connectors (7-pin SATA1-6)	2-27
5.	USB connectors (10-1 pin USB78, USB910, USB1112)	2-28
6.	Optical drive audio connector (4-pin CD)	2-28
7.	CPU, chassis, and power fan connectors (4-pin CPU_FAN, 3-pin CHA_FAN, 3-pin PWR_FAN)	2-29
8.	Serial port connector (10-1 pin COM1)	2-29
9.	Chassis intrusion connector (4-1 pin CHASSIS)	2-30
10.	Front panel audio connector (10-1 pin AAFP)	2-30
11.	ATX power connectors (24-pin EATXPWR, 4-pin EATX12V)	2-31
12.	System panel connector (20-8 pin PANEL)	2-32
	<ul style="list-style-type: none"> • System power LED (2-pin PLED) • Hard disk drive activity LED (2-pin IDE_LED) • System warning speaker (4-pin SPEAKER) • ATX power button/soft-off button (2-pin PWRSW) • Reset button (2-pin RESET) 	
	ASUS Q-connector (system panel)	2-33

2.3 Central Processing Unit (CPU)

The motherboard comes with a surface mount LGA775 socket designed for the Intel® Core™2 Extreme / Core™2 Quad / Core™2 Duo / Pentium® Dual-Core / Celeron® Dual-Core / Celeron® processors.



- Ensure that all power cables are unplugged before installing the CPU.
 - Connect the chassis fan cable to the CHA_FAN connector to ensure system stability.
-



- Upon purchase of the motherboard, make sure that the PnP cap is on the socket and the socket contacts are not bent. Contact your retailer immediately if the PnP cap is missing, or if you see any damage to the PnP cap/socket contacts/motherboard components. ASUS will shoulder the cost of repair only if the damage is shipment/transit-related.
 - Keep the cap after installing the motherboard. ASUS will process Return Merchandise Authorization (RMA) requests only if the motherboard comes with the cap on the LGA775 socket.
 - The product warranty does not cover damage to the socket contacts resulting from incorrect CPU installation/removal, or misplacement/loss/incorrect removal of the PnP cap.
-

2.3.1 Installing the CPU

To install a CPU:

1. Locate the CPU socket on the motherboard.

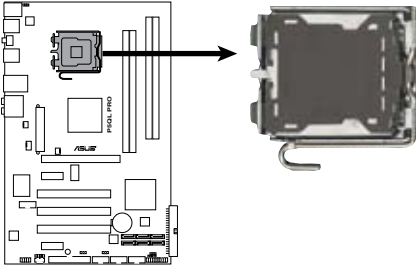

P5QL PRO CPU Socket 775



Before installing the CPU, ensure that the socket box is facing towards you and the load lever is on your left.

2. Press the load lever with your thumb (A), then move it to the left (B) until it is released from the retention tab.



To prevent damage to the socket pins, do not remove the PnP cap unless you are installing a CPU.

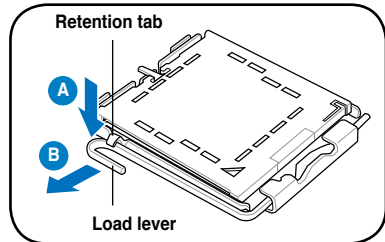

3. Lift the load lever in the direction of the arrow to a 135° angle.
4. Lift the load plate with your thumb and forefinger to a 100° angle (4A), then push the PnP cap from the load plate window to remove (4B).

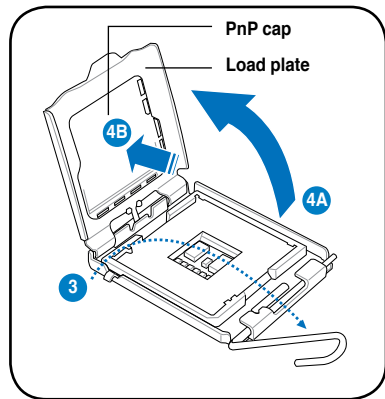

5. Position the CPU over the socket, ensuring that the gold triangle is on the bottom-left corner of the socket then fit the socket alignment key into the CPU notch.

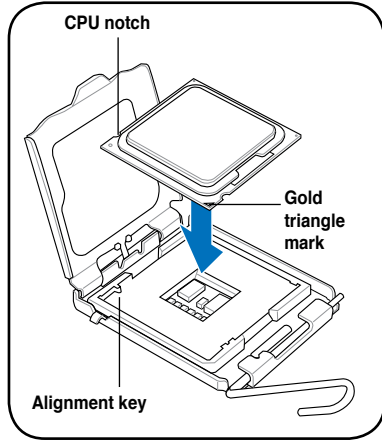

6. Apply several drops of Thermal Interface Material to the exposed area of the CPU that the heatsink will be in contact with, ensuring that it is spread in an even thin layer.



Some heatsinks come with pre-applied thermal paste. If so, skip this step.

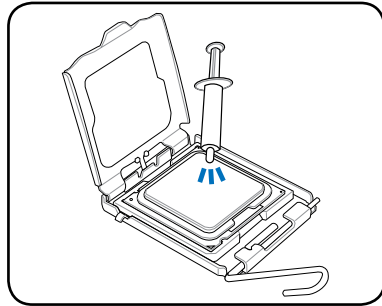

DO NOT eat the Thermal Interface Material. If it gets into your eyes or touches your skin, ensure that you wash it off immediately, and seek professional medical help.



To prevent contaminating the paste, **DO NOT** spread the paste with your finger directly.

7. Close the load plate (A), then push the load lever (B) until it snaps into the retention tab.

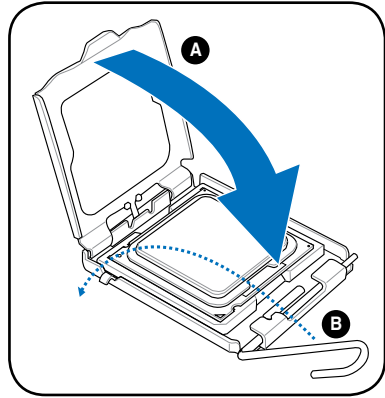

The motherboard supports Intel® LGA775 processors with the Intel® Enhanced Intel SpeedStep® Technology (EIST) and Hyper-Threading Technology. Refer to the Appendix for more information on these CPU features.

2.3.2 Installing the CPU heatsink and fan

The Intel® LGA775 processor requires a specially designed heatsink and fan assembly to ensure optimum thermal condition and performance.



- When you buy a boxed Intel® processor, the package includes the CPU fan and heatsink assembly. If you buy a CPU separately, ensure that you use only Intel®-certified multi-directional heatsink and fan.
- Your Intel® LGA775 heatsink and fan assembly comes in a push-pin design and requires no tool to install.
- If you purchased a separate CPU heatsink and fan assembly, make sure that you have properly applied Thermal Interface Material to the CPU heatsink or CPU before you install the heatsink and fan assembly.



Ensure that you have installed the motherboard to the chassis before you install the CPU fan and heatsink assembly.

To install the CPU heatsink and fan:

1. Place the heatsink on top of the installed CPU, making sure that the four fasteners match the holes on the motherboard.
2. Push down two fasteners at a time in a diagonal sequence to secure the heatsink and fan assembly in place.

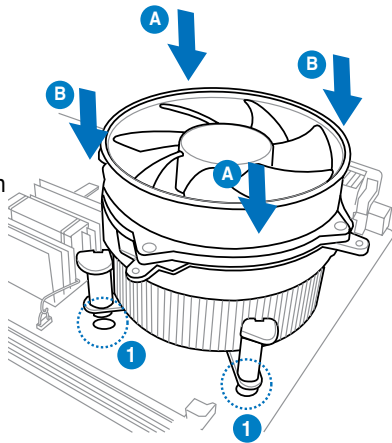
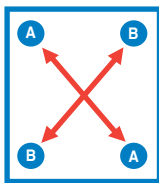

The type of CPU heatsink and fan assembly may differ, but the installation steps and functions should remain the same. The illustration above is for reference only.

3. Connect the CPU fan cable to the connector on the motherboard labeled CPU_FAN.

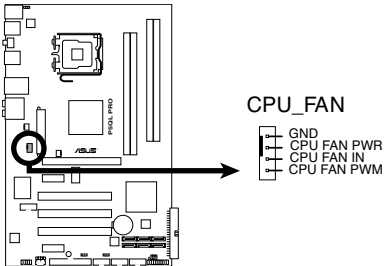

P5QL PRO CPU Fan Connector



Do not forget to connect the CPU fan connector! Hardware monitoring errors can occur if you fail to plug this connector.

2.3.3 Uninstalling the CPU heatsink and fan

To uninstall the CPU heatsink and fan

1. Disconnect the CPU fan cable from the connector on the motherboard.
2. Rotate each fastener counterclockwise.
3. Pull up two fasteners at a time in a diagonal sequence to disengage the heatsink and fan assembly from the motherboard.

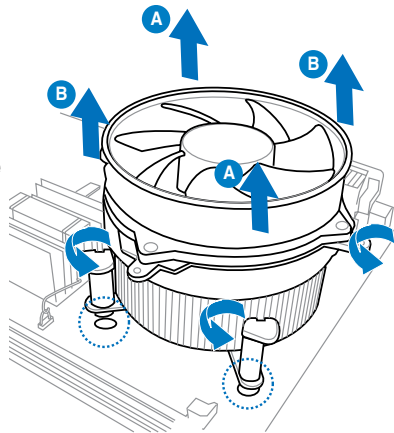
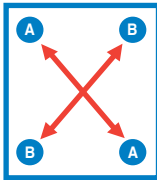

4. Carefully remove the heatsink and fan assembly from the motherboard.

2.4 System memory

2.4.1 Overview

The motherboard comes with four Double Data Rate 2 (DDR2) Dual Inline Memory Modules (DIMM) sockets.

The figure illustrates the location of the DDR2 DIMM sockets:

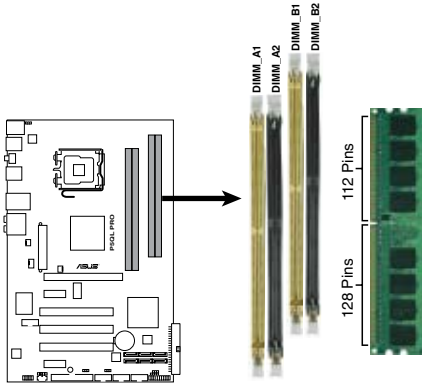

P5QL PRO 240-pin DDR2 DIMM Sockets

Channel	Sockets
Channel A	DIMM_A1 and DIMM_A2
Channel B	DIMM_B1 and DIMM_B2

2.4.2 Memory configurations

You may install 512MB, 1GB, 2GB, and 4GB unbuffered non-ECC DDR2 DIMMs into the DIMM sockets.

Recommended Memory Configurations

Mode	Sockets			
	DIMM_A1	DIMM_A2	DIMM_B1	DIMM_B2
Single-Channel	-	-	Populated	-
	Populated	-	-	-
Dual-channel (1)	Populated	-	Populated	-
Dual-channel (2)	Populated	Populated	Populated	Populated



-
- You may install varying memory sizes in Channel A and Channel B. The system maps the total size of the lower-sized channel for the dual-channel configuration. Any excess memory from the higher-sized channel is then mapped for single-channel operation.
 - Always install DIMMs with the same CAS latency. For optimum compatibility, it is recommended that you obtain memory modules from the same vendor.
 - If you are using a Windows 32-bit version operating system (e.g. 32-bit Windows XP, 32-bit Vista) without the Physical Address Extension (PAE) support, the system will allocate a certain amount of memory space for system devices.
 - We recommend that you install only a maximum of 3GB system memory when using a Windows 32-bit version operating system without the PAE. The excess over 3GB of installed memory will not cause any problem; however, the system can not use this excess memory space and the system will display less than the total size of physical memory installed.
 - This motherboard does not support memory modules made up of 128 Mb chips.
-



This motherboard can support up to 16GB on the operating systems listed below. You may install a maximum of 4GB DIMMs on each slot.

64-bit

Windows® XP Professional x64 Edition

Windows® Vista x64 Edition



-
- The default memory operation frequency is dependent on its SPD. Under the default state, some memory modules for overclocking may operate at lower frequency than the vendor-marked value. To operate at the vendor-marked or at a higher frequency, see section **4.4 Ai Tweaker menu** for manual memory frequency adjustment.
 - The memory modules may require a better cooling system to work stably under full loading (4 DIMMs) or overclocking setting.
 - Some old-version DDR2-800 DIMMs may not match Intel®'s On-Die-Termination (ODT) requirement and will automatically downgrade to run at DDR2-667. If this happens, contact your memory vendor to check the ODT value.
 - Due to chipset limitation, DDR2-800 with CL=4 will be downgraded to run at DDR2-667 by default setting. If you want to operate with lower latency, adjust the memory timing manually.
-

P5QL PRO Motherboard Qualified Vendors Lists (QVL) DDR2-1066MHz capability

Size	Vendor	Part No.	CL	Chip Brand	SS/ DS	Chip No.	DIMM support		
							A*	B*	C*
512MB	Kingston	KHX8500D2/512	N/A	Kingston	SS	Heat-Sink Package	.	.	.
512MB	Kingston	KVR1066D2N7/512	N/A	Elpida	SS	E5108AJBG-1J-E	.	.	.
1G	Kingston	KHX8500D2K2/2GN	N/A	Kingston	DS	Heat-Sink Package	.	.	.
1G	Kingston	KVR1066D2N7/1G	N/A	Elpida	DS	E5108AJBG-1J-E	.	.	.
1G	Kingston	KHX8500D2/1G	N/A	Kingston	DS	Heat-Sink Package	.	.	.
1G	Qimonda	HYS64T128020EU-19F-C	6	Qimonda	DS	HYB18T512800CF19FFSS24313	.	.	.
1G	Kingmax	KLED48F-A8K15	N/A	Kingmax	DS	KK48FFIXF-JFS-18A	.	.	.
1G	Transcend	TX1066QLJ-2GK1GB	5	Transced	DS	Heat-Sink Package	.	.	.
1G	GEIL	GB22GB8500C5DC	5	GEIL	SS	GL2L128M88BA25AB	.	.	.
1G	GEIL	GB24GB8500C5QC	5	GEIL	SS	GL2L128M88BA25AB	.	.	.
1G	GEIL	GE22GB1066C5DC	5	GEIL	DS	Heat-Sink Package	.	.	.
1G	GEIL	GE24GB1066C5QC	5	GEIL	DS	Heat-Sink Package	.	.	.
2G	GEIL	GB24GB8500C5DC	5	GEIL	DS	GL2L128M88BA25AB	.	.	.
512MB	AENEON	AXT660UD00-19DC97X	5	AENEON	SS	Heat-Sink Package	.	.	.
1G	AENEON	AXT760UD00-19DC97X	5	AENEON	DS	Heat-Sink Package	.	.	.



If you install a DDR2-1066 memory module whose SPD is DDR2-800, make sure that you set the **DRAM Frequency** item in BIOS to [DDR2-1066MHz]. See section **4.4 Ai Tweaker menu** for details.

DDR2-800MHz capability

Size	Vendor	Part No.	CL	Chip Brand	SS/ DS	Chip No.	DIMM support		
							A*	B*	C*
1G	Kingston	KHX6400D2LL/1G	N/A	Kingston	DS	Heat-Sink Package	.	.	.
512MB	Kingston	KHX6400D2LLK2/1GN	N/A	Kingston	SS	Heat-Sink Package	.	.	.
512MB	Kingston	KVR800D2N5/512	N/A	Promos	SS	V59C1512804QCF25SY032406PECPA	.	.	.
512MB	Kingston	KVR800D2N6/512	N/A	Elpida	SS	E5108AJBG-8E-E	.	.	.
1G	Kingston	KVR800D2N5/1G	N/A	Elpida	DS	E5108AJBG-8E-E	.	.	.
1G	Kingston	KVR800D2N6/1G	N/A	Elpida	DS	E5108AJBG-8E-E	.	.	.
2G	Kingston	KVR800D2N5/2G	N/A	Elpida	DS	E1108ACBG-8E-E	.	.	.
4G	Kingston	N/A	N/A	Elpida	DS	E2108ABSE-8G-E	.	.	.
512MB	Samsung	M378T6553GZS-CF7	6	Samsung	SS	K4T51083QG-HCF7	.	.	.
1G	Samsung	M378T2863QZS-CF7	6	Samsung	SS	K4T1G084QQ-HCF7	.	.	.
1G	Samsung	M378T2953GZ3-CF7	6	Samsung	DS	K4T51083QG-HCF7	.	.	.
2G	Samsung	M37875663QZ3-CF7	6	Samsung	DS	K4T1G084QQ-HCF7	.	.	.
512MB	Qimonda	HYS64T64000EU-2.5-B2	6	Qimonda	SS	HYB18T512800B2F25FSS28380	.	.	.
1G	Qimonda	HYS64T128020EU-2.5-B2	6	Qimonda	DS	HYB18T512800B2F25FSS28380	.	.	.
1G	Corsair	XMS2-6400	4	Corsair	DS	Heat-Sink Package	.	.	.
1G	Corsair	XMS2-6400	5	Corsair	DS	Heat-Sink Package	.	.	.
512MB	HY	HYMP564U64CP8-S5 AB	5	Hynix	SS	HY5PS12821CFP-S5	.	.	.
1G	HY	HYMP512U64CP8-S5 AB	5	Hynix	DS	HY5PS12821CFP-S5	.	.	.
512MB	Kingmax	KLDC28F-A8K15	N/A	Kingmax	SS	KK48FFIXF-JFS-25A	.	.	.
1G	Kingmax	KLDD48F-A8K15	N/A	Kingmax	DS	KK48FFIXF-HFS-25A	.	.	.
512MB	Apacer	78.91G91.9K5	5	Apacer	SS	AM4B5708JQJS8E0751C	.	.	.
1G	Apacer	78.01GA0.9K5	5	Apacer	SS	AM4B5808CQJS8E0749D	.	.	.
2G	Apacer	78.A1GA0.9K4	5	Apacer	DS	AM4B5808CQJS8E0747D	.	.	.

(continued on the next page)

DDR2-800MHz capability

Size	Vendor	Part No.	CL	Chip Brand	SS/ DS	Chip No.	DIMM support		
							A*	B*	C*
512MB	Transcend	TS128MLQ64V8J512MB	N/A	Micron	SS	7HD22 D9GMH	.	.	.
512MB	Transcend	TS64MLQ64V8J512MB	N/A	Transcend	SS	Heat-Sink Package	.	.	.
512MB	ADATA	M2OAD6G3H3160Q1E58	N/A	ADATA	SS	AD29608A8A-25EG80812	.	.	.
512MB	VDATA	M2GVD6G3H3160Q1E52	N/A	VDATA	SS	VD29608A8A-25EG20813	.	.	.
1G	ADATA	M2OAD6G314170Q1E58	N/A	ADATA	DS	AD29608A8A-25EG80810	.	.	.
1G	VDATA	M2GVD6G314170Q1E58	N/A	VDATA	DS	VD29608A8A-25EG80813	.	.	.
1G	PSC	AL7E8F73C-8E1	5	PSC	SS	A3R1GE3CFF734MAA0E	.	.	.
2G	PSC	AL8E8F73C-8E1	5	PSC	DS	A3R1GE3CFF734MAA0E	.	.	.
1G	GEIL	GB22GB6400C4DC	4	GEIL	DS	GL2L64M088BA30EB	.	.	.
1G	GEIL	GB24GB6400C4QC	4	GEIL	DS	GL2L64M088BA30EB	.	.	.
1G	GEIL	GB22GB6400C5DC	5	GEIL	DS	GL2L64M088BA30EB	.	.	.
1G	GEIL	GB24GB6400C5QC	5	GEIL	DS	GL2L64M088BA30EB	.	.	.
1G	GEIL	GX22GB6400DC	5	GEIL	DS	Heat-Sink Package	.	.	.
1G	GEIL	GE22GB800C4DC	4	GEIL	DS	Heat-Sink Package	.	.	.
1G	GEIL	GE24GB800C4QC	4	GEIL	DS	Heat-Sink Package	.	.	.
1G	GEIL	GX22GB6400UDC	4	GEIL	DS	Heat-Sink Package	.	.	.
1G	GEIL	GE22GB800C5DC	5	GEIL	DS	Heat-Sink Package	.	.	.
1G	GEIL	GE24GB800C5QC	5	GEIL	DS	Heat-Sink Package	.	.	.
2G	GEIL	GB24GB6400C4DC	4	GEIL	DS	GL2L128M88BA25AB	.	.	.
2G	GEIL	GB24GB6400C5DC	5	GEIL	DS	GL2L128M88BA25AB	.	.	.
2G	GEIL	GB28GB6400C5QC	5	GEIL	DS	GL2L128M88BA25AB	.	.	.
2G	GEIL	GB28GB6400C4QC	4	GEIL	DS	GL2L128M88BA25AB	.	.	.
2G	GEIL	GX22GB6400LX	5	GEIL	DS	Heat-Sink Package	.	.	.
2G	GEIL	GX24GB6400DC	5	GEIL	DS	Heat-Sink Package	.	.	.
2G	GEIL	GE28GB800C5QC	5	GEIL	DS	Heat-Sink Package	.	.	.
2G	GEIL	GE28GB800C4QC	4	GEIL	DS	Heat-Sink Package	.	.	.
2G	GEIL	GX22GB6400CUSC	4	GEIL	DS	Heat-Sink Package	.	.	.
2G	GEIL	GE24GB800C4DC	4	GEIL	DS	Heat-Sink Package	.	.	.
2G	GEIL	GE24GB800C5DC	5	GEIL	DS	Heat-Sink Package	.	.	.
1G	Super Talent	T800UB1GC4	4	Super Talent	DS	Heat-Sink Package	.	.	.
1G	G.SKILL	F2-6400CL5D-2GBNQ	5	G.SKILL	DS	Heat-Sink Package	.	.	.
1G	G.SKILL	F2-6400CL4D-2GBPK	4	G.SKILL	DS	Heat-Sink Package	.	.	.
1G	G.SKILL	F2-6400CL4D-2GBHK	4	G.SKILL	DS	Heat-Sink Package	.	.	.
2G	G.SKILL	F2-6400CL5D-4GBPQ	5	G.SKILL	DS	Heat-Sink Package	.	.	.
2G	G.SKILL	F2-6400CL4D-4GBPK	4	G.SKILL	DS	Heat-Sink Package	.	.	.
4G	G.SKILL	F2-6400CL5Q-16GNQ	5	G.SKILL	DS	Heat-Sink Package	.	.	.
1G	OCZ	OCZ2RPR8002GK	4	OCZ	DS	Heat-Sink Package	.	.	.
1G	OCZ	OCZ2G800R22GK	5	OCZ	DS	Heat-Sink Package	.	.	.
1G	OCZ	OCZ2P800R22GK	4	OCZ	DS	Heat-Sink Package	.	.	.
1G	OCZ	OCZ2VU8004GK	6	OCZ	DS	Heat-Sink Package	.	.	.
2G	OCZ	OCZ2P8004GK	5	OCZ	DS	Heat-Sink Package	.	.	.
1G	Elixir	M2Y1G64TU8HB0B-25C	5	Elixir	DS	N2TU51280BE-25C802006Z1DV	.	.	.

DDR2-667MHz capability

Size	Vendor	Part No.	CL	Chip Brand	SS/ DS	Chip No.	DIMM support		
							A*	B*	C*
512MB	Kingston	KVR667D2N5/512	N/A	Hynix	SS	HY5PS12821EFP-Y5	.	.	.
1G	Kingston	KVR667D2N5/1G	N/A	Hynix	DS	HY5PS12821EFP-Y5	.	.	.
2G	Kingston	KVR667D2N5/2G	N/A	Micron	DS	7RE22 D9HNL	.	.	.
512MB	Qimonda	HYS64T64000EU-3S-B2	5	Qimonda	SS	HYB18T512B00B2F3SFSS28171	.	.	.
1G	Qimonda	HYS64T128020EU-3S-B2	5	Qimonda	DS	HYB18T512B00B2F3SFSS28171	.	.	.
512MB	Corsair	V5S12MB667D2	N/A	Corsair	SS	64M6CFEGP9000647	.	.	.
1G	Corsair	V51GB667D2	N/A	Corsair	DS	MID095D62864M8CEC	.	.	.
1G	Corsair	XMS2-5400	4	Corsair	DS	Heat-Sink Package	.	.	.
1G	HY	HYMP512U64CP8-Y5 AB	5	Hynix	DS	HY5PS12521CFP-Y5	.	.	.
512MB	Kingmax	KLCC28F-A8KB5	N/A	Kingmax	SS	KKEA88B4LAUG-29DX	.	.	.
1G	Kingmax	KLCD48F-A8KB5	N/A	Kingmax	DS	KKEA88B4LAUG-29DX	.	.	.
512MB	Apacer	AU512E667C5KBGC	5	Apacer	SS	AM4B5708MIJ57E0627B	.	.	.
512MB	Apacer	AU512E667C5KBGC	5	Apacer	SS	AM4B5708GQJ57E06332F	.	.	.
512MB	Apacer	78.91G92.9K5	5	Apacer	SS	AM4B5708JQJ57E0751C	.	.	.
1G	Apacer	78.01G90.9K5	5	Apacer	SS	AM4B5808CQJ57E0751C	.	.	.
1G	Apacer	AU01GE667C5KBGC	N/A	Apacer	DS	AM4B5708GQJ57E0636B	.	.	.
1G	Apacer	AU01GE667C5KBGC	5	Apacer	DS	AM4B5708MIJ57E0627B	.	.	.
2G	Apacer	78.A1G90.9K4	5	Apacer	DS	AM4B5808CQJ57E0749B	.	.	.
1G	Transcend	506010-4894	5	Elpida	DS	E5108AJBG-6E-E	.	.	.
512MB	ADATA	M2OAD5G3H3160Q1C52	N/A	ADATA	SS	AD29608A8A-3EG20813	.	.	.
2G	ADATA	M2OAD5H3J417011C53	N/A	ADATA	DS	AD20908A8A-3EG 30724	.	.	.
512MB	PSC	AL6E8E63J-6E1	5	PSC	SS	A3R12E3JFF717B9A00	.	.	.
1G	PSC	AL7E8E63J-6E1	5	PSC	DS	A3R12E3JFF717B9A01	.	.	.
1G	PSC	AL7E8F73C-6E1	5	PSC	SS	A3R1GE3CFF734MAA0J	.	.	.
2G	PSC	AL8E8F73C-6E1	5	PSC	DS	A3R1GE3CFF733MAA00	.	.	.
512MB	Nanya	NT512T64U88A1B1Y-3C	N/A	Nanya	SS	NT5TU64M8AE-3C	.	.	.
1G	Nanya	NT1GT64U88B0B1Y-3C	5	Nanya	DS	NT5TU64M8BE-3C72155700CP	.	.	.
1G	GEIL	GX21GB5300SX	3	GEIL	DS	Heat-Sink Package	.	.	.
2G	GEIL	GX22GB5300LX	5	GEIL	DS	Heat-Sink Package	.	.	.
2G	GEIL	GX24GB5300LDC	5	GEIL	DS	Heat-Sink Package	.	.	.
1G	Super Talent	T667UB1GV	5	Super Talent	DS	PG 64M8-800 0750	.	.	.
512MB	Twinmos	8D-A3JK5MPETP	5	PSC	SS	A3R12E3GEF633ACA0Y	.	.	.
1G	ELIXIR	M2Y1G64TU8HA2B-3C	5	ELIXIR	DS	M2TU51280AE-3C717095R28F	.	.	.
1G	ELIXIR	M2Y1G64TU8HB0B-3C	5	ELIXIR	DS	N2TU51280BE-3C639009W1CF	.	.	.
1G	Leadmax	LRMP512U64A8-Y5	N/A	Hynix	DS	HY5PS12821CFP-Y5 C 702AA	.	.	.



SS - Single-sided / DS - Double - sided

DIMM support:

- **A*:** Supports one module inserted into any slot as Single-channel memory configuration.
- **B*:** Supports one pair of modules inserted into either the yellow slots or the black slots as one pair of Dual-channel memory configuration.
- **C*:** Supports four modules inserted into both the yellow slots and the black slots as two pairs of Dual-channel memory configuration.



Visit the ASUS website for the latest DDR2-1066/800/667MHz QVL.

2.4.3 Installing a DIMM



Unplug the power supply before adding or removing DIMMs or other system components. Failure to do so can cause severe damage to both the motherboard and the components.

1. Unlock a DDR2 DIMM socket by pressing the retaining clips outward.
2. Align a DIMM on the socket such that the notch on the DIMM matches the break on the socket.

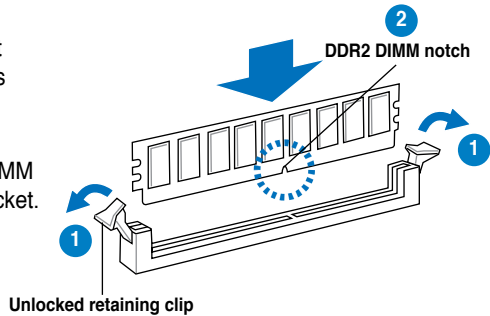

A DDR2 DIMM is keyed with a notch so that it fits in only one direction. **DO NOT** force a DIMM into a socket to avoid damaging the DIMM.

3. Firmly insert the DIMM into the socket until the retaining clips snap back in place and the DIMM is properly seated.

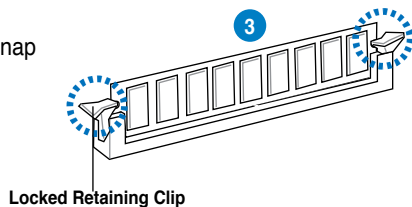

2.4.4 Removing a DIMM

To remove a DIMM:

1. Simultaneously press the retaining clips outward to unlock the DIMM.



Support the DIMM lightly with your fingers when pressing the retaining clips. The DIMM might get damaged when it flips out with extra force.

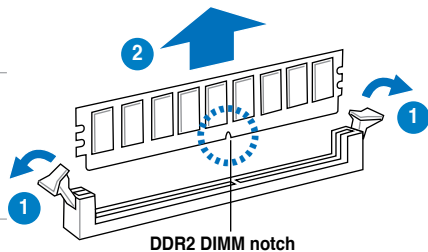

2. Remove the DIMM from the socket.

2.5 Expansion slots

In the future, you may need to install expansion cards. The following sub-sections describe the slots and the expansion cards that they support.



Ensure to unplug the power cord before adding or removing expansion cards. Failure to do so may cause you physical injury and damage motherboard components.

2.5.1 Installing an expansion card

To install an expansion card:

1. Before installing the expansion card, read the documentation that came with it and make the necessary hardware settings for the card.
2. Remove the system unit cover (if your motherboard is already installed in a chassis).
3. Remove the bracket opposite the slot that you intend to use. Keep the screw for later use.
4. Align the card connector with the slot and press firmly until the card is completely seated on the slot.
5. Secure the card to the chassis with the screw you removed earlier.
6. Replace the system cover.

2.5.2 Configuring an expansion card

After installing the expansion card, configure it by adjusting the software settings.

1. Turn on the system and change the necessary BIOS settings, if any. See Chapter 4 for information on BIOS setup.
2. Assign an IRQ to the card. Refer to the tables on the next page.
3. Install the software drivers for the expansion card.



When using PCI cards on shared slots, ensure that the drivers support “Share IRQ” or that the cards do not need IRQ assignments. Otherwise, conflicts will arise between the two PCI groups, making the system unstable and the card inoperable. Refer to the table on the next page for details.

2.5.3 Interrupt assignments

Standard interrupt assignments

IRQ	Standard function
0	System timer
1	Standard 101/102-Key or Microsoft Natural Keyboard
2	Free
3	Free
4	Communications port (COM1)
5	Free
6	Standard floppy
7	Free
8	System CMOS/Real Time Clock
9	Microsoft ACPI-compliant system
10	Free
11	Free
12	Microsoft PS/2 mouse port
13	Numeric data processor
14	Free
15	Intel® ICH10 Family SM Bus controller-3A30

IRQ assignments for this motherboard

	A	B	C	D	E	F	G	H
PCIe X1 slot	shared	shared	shared	shared	-	-	-	-
PCIe X1 slot	shared	shared	shared	shared	-	-	-	-
PCIe X16 slot	shared	shared	shared	shared	-	-	-	-
Onboard USB1.1 controller 1	-	-	-	-	-	-	-	shared
Onboard USB1.1 controller 2	-	-	-	shared	-	-	-	-
Onboard USB1.1 controller 3	-	-	shared	-	-	-	-	-
Onboard USB1.1 controller 4	shared	-	-	-	-	-	-	-
Onboard USB1.1 controller 5	shared	-	-	-	-	-	-	-
Onboard USB1.1 controller 6	-	-	-	-	-	shared	-	-
Onboard USB1.1 controller 7	-	-	shared	-	-	-	-	-
Onboard USB2.0 controller 1	-	-	-	-	-	-	-	shared
Onboard USB2.0 controller 2	-	-	shared	-	-	-	-	-
Onboard IDE PORT	shared	-	-	-	-	-	-	-
Onboard HD Audio	-	-	-	-	-	-	shared	-
Onboard LAN	-	shared	-	-	-	-	-	-
Onchip SATA1	-	-	shared	shared	-	-	-	-
Onchip SATA2	-	-	shared	-	-	-	-	-
PCI Card1	shared	shared	shared	shared	-	-	-	-
PCI Card2	shared	shared	shared	shared	-	-	-	-
PCI Card3	shared	shared	shared	shared	-	-	-	-

2.5.4 PCI slots

The PCI slots support cards such as a LAN card, SCSI card, USB card, and other cards that comply with PCI specifications. The photo shows a LAN card installed on a PCI slot.

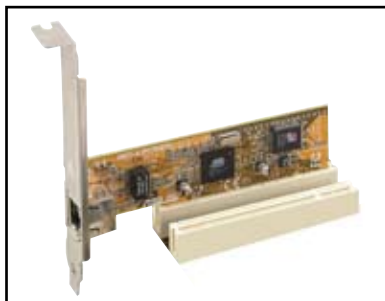

2.5.5 PCI Express x1 slots

This motherboard supports PCI Express x1 network cards, SCSI cards and other cards that comply with the PCI Express specifications. The following photo shows a network card installed on the PCI Express x1 slot.

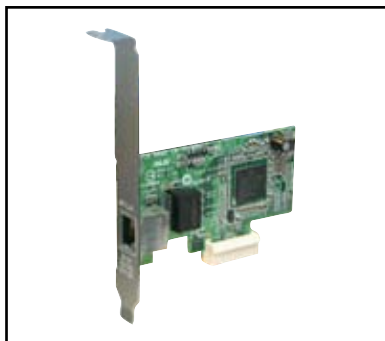

2.5.6 PCI Express x16 slot

This motherboard supports one PCI Express x16 graphics card that complies with the PCI Express specifications. The photo shows a graphics card installed on the PCI Express x16 slot.



2.6 Jumpers

1. Clear RTC RAM (3-pin CLRRTC)

This jumper allows you to clear the Real Time Clock (RTC) RAM in CMOS. You can clear the CMOS memory of date, time, and system setup parameters by erasing the CMOS RTC RAM data. The onboard button cell battery powers the RAM data in CMOS, which include system setup information such as system passwords.

To erase the RTC RAM:

1. Turn OFF the computer and unplug the power cord.
2. Remove the onboard battery.
3. Move the jumper cap from pins 1-2 (default) to pins 2-3. Keep the cap on pins 2-3 for about 5~10 seconds, then move the cap back to pins 1-2.
4. Reinstall the battery.
5. Plug the power cord and turn ON the computer.
6. Hold down the key during the boot process and enter BIOS setup to re-enter data.



Except when clearing the RTC RAM, never remove the cap on CLRRTC jumper default position. Removing the cap will cause system boot failure!

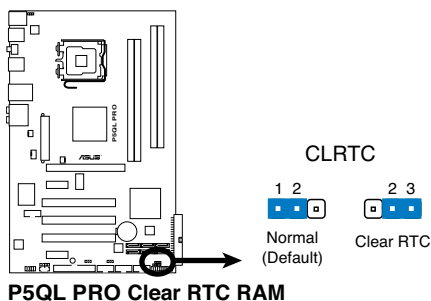

- You do not need to clear the RTC when the system hangs due to overclocking. For system failure due to overclocking, use the C.P.R. (CPU Parameter Recall) feature. Shut down and reboot the system so the BIOS can automatically reset parameter settings to default values.
- Due to the chipset limitation, AC power off is required prior using C.P.R. function. You must turn off and on the power supply or unplug and plug the power cord before reboot the system.

2. Keyboard power (3-pin PS2_USBW56)

This jumper allows you to enable or disable the keyboard and USB port 5-6 wake-up feature. When you set this jumper to pins 2-3 (+5VSB), you can wake up the computer by pressing a key on the keyboard (the default is the Space Bar) or using a USB device. This feature requires an ATX power supply that can supply at least 1A on the +5VSB lead, and a corresponding setting in the BIOS. The USBPW56 jumper is for the internal USB connectors that you can connect to additional USB ports.

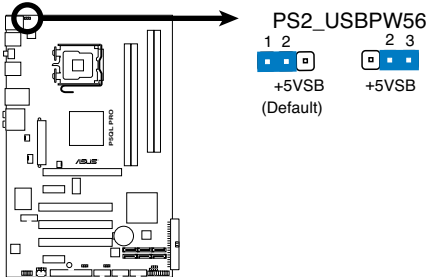

P5QL PRO Keyboard Power Setting

3. USB device wake-up (3-pin USBPW1-4, USBPW7-10, USBPW1112)

Set these jumpers to +5V to wake up the computer from S1 sleep mode (CPU stopped, DRAM refreshed, system running in low power mode) using the connected USB devices. Set to +5VSB to wake up from S3 and S4 sleep modes (no power to CPU, DRAM in slow refresh, power supply in reduced power mode).

The USBPW1-4 and PS2_USBW56 jumpers are for the rear USB ports. The USBPW7-10 and USB1112 jumpers are for the internal USB connectors that you can connect to additional USB ports.

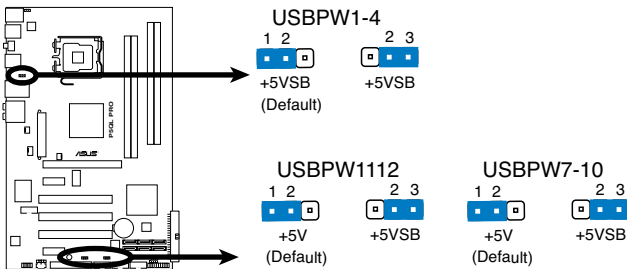

P5QL PRO USB Device Wake Up



- The USB device wake-up feature requires a power supply that can provide 500mA on the +5VSB lead for each USB port; otherwise, the system would not power up.
- The total current consumed must NOT exceed the power supply capability (+5VSB) whether under normal condition or in sleep mode.

2.7 Connectors

2.7.1 Rear panel connectors

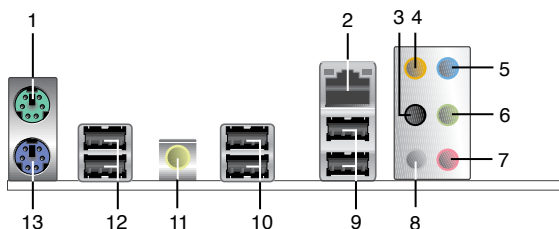

1. **PS/2 mouse port (green).** This port is for a PS/2 mouse.
2. **LAN (RJ-45) port.** Supported by Gigabit LAN controller, this port allows Gigabit connection to a Local Area Network (LAN) through a network hub. Refer to the table below for the LAN port LED indications.

LAN port LED indications

ACT/LINK LED		SPEED LED	
Status	Description	Status	Description
OFF	No link	OFF	10 Mbps connection
YELLOW	Linked	ORANGE	100 Mbps connection
BLINKING	Data activity	GREEN	1 Gbps connection

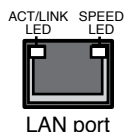

3. **Rear Speaker Out port (black).** This port connects the rear speakers in a 4-channel, 6-channel, or 8-channel audio configuration.
4. **Center/Subwoofer port (orange).** This port connects the center/subwoofer speakers.
5. **Line In port (light blue).** This port connects the tape, CD, DVD player, or other audio sources.
6. **Line Out port (lime).** This port connects a headphone or a speaker. In 4-channel, 6-channel, and 8-channel configuration, the function of this port becomes Front Speaker Out.

7. **Microphone port (pink).** This port connects a microphone.
8. **Side Speaker Out port (gray).** This port connects the side speakers in an 8-channel audio configuration.



Refer to the audio configuration table on the next page for the function of the audio ports in 2, 4, 6, or 8-channel configuration.

Audio 2, 4, 6, or 8-channel configuration

Port	Headset 2-channel	4-channel	6-channel	8-channel
Light Blue	Line In	Line In	Line In	Line In
Lime	Line Out	Front Speaker Out	Front Speaker Out	Front Speaker Out
Pink	Mic In	Mic In	Mic In	Mic In
Orange	–	–	Center/Subwoofer	Center/Subwoofer
Black	–	Rear Speaker Out	Rear Speaker Ou	Rear Speaker Out
Gray	–	–	–	Side Speaker Out

9. **USB 2.0 ports 1 and 2.** These two 4-pin Universal Serial Bus (USB) ports are available for connecting USB 2.0 devices.
10. **USB 2.0 ports 3 and 4.** These two 4-pin Universal Serial Bus (USB) ports are available for connecting USB 2.0 devices.
11. **Coaxial S/PDIF Out port.** This port connects an external audio output device via a coaxial S/PDIF cable.
12. **USB 2.0 ports 5 and 6.** These two 4-pin Universal Serial Bus (USB) ports are available for connecting USB 2.0 devices.
13. **PS/2 keyboard port (purple).** This port is for a PS/2 keyboard.

2.7.2 Internal connectors

1. Floppy disk drive connector (34-1 pin FLOPPY)

This connector is for the provided floppy disk drive (FDD) signal cable. Insert one end of the cable to this connector, then connect the other end to the signal connector at the back of the floppy disk drive.



Pin 5 on the connector is removed to prevent incorrect cable connection when using a FDD cable with a covered Pin 5.

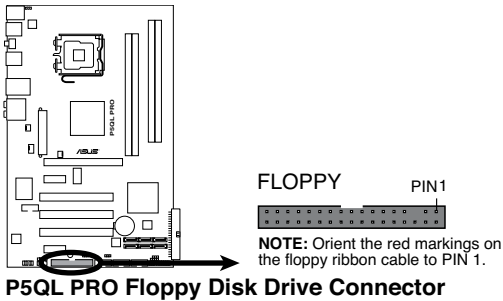

2. Digital audio connector (4-1 pin SPDIF_OUT)

This connector is for an additional Sony/Philips Digital Interface (S/PDIF) port(s). Connect the S/PDIF Out module cable to this connector, then install the module to a slot opening at the back of the system chassis.

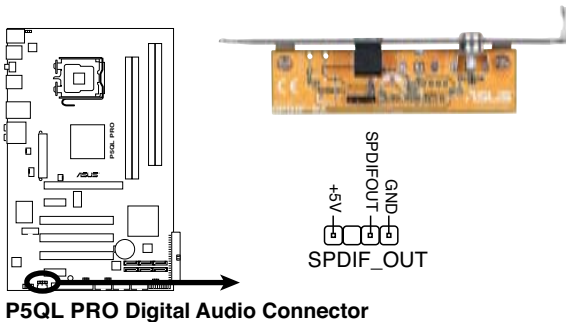

The S/PDIF module is purchased separately.

3. IDE connector (40-1 pin PRL_EIDE)

The onboard IDE connector is for the Ultra DMA 133/100/66 signal cable. There are three connectors on each Ultra DMA 133/100/66 signal cable: blue, black, and gray. Connect the blue connector to the motherboard's IDE connector, then select one of the following modes to configure your device.

	Drive jumper setting	Mode of device(s)	Cable connector
Single device	Cable-Select or Master	-	Black
Two devices	Cable-Select	Master	Black
		Slave	Gray
	Master	Master	Black or gray
	Slave	Slave	



- Pin 20 on the IDE connector is removed to match the covered hole on the Ultra DMA cable connector. This prevents incorrect insertion when you connect the IDE cable.
- Use the 80-conductor IDE cable for Ultra DMA 133/100/66 IDE devices.



If any device jumper is set as "Cable-Select," make sure all other device jumpers have the same setting.

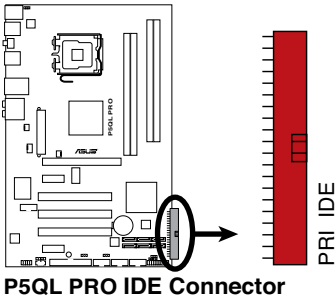

4. Serial ATA connectors (7-pin SATA1-6)

These connectors are for the Serial ATA signal cables for Serial ATA hard disk drives.

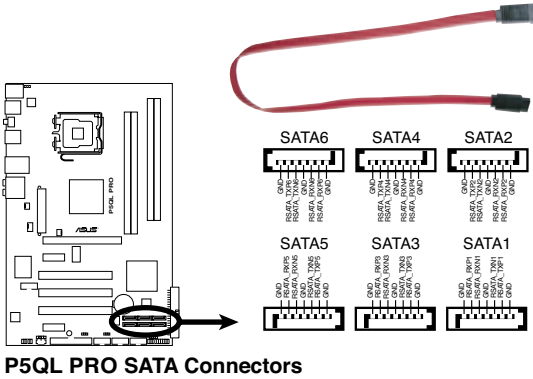

Connect the right-angle side of SATA signal cable to SATA device. Or you may connect the right-angle side of SATA cable to the onboard SATA port to avoid mechanical conflict with huge graphics cards.

right angle side

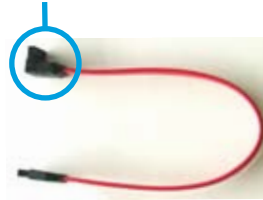

5. USB connectors (10-1 pin USB78, USB910, USB1112)

These connectors are for USB 2.0 ports. Connect the USB module cable to any of these connectors, then install the module to a slot opening at the back of the system chassis. These USB connectors comply with USB 2.0 specification that supports up to 480 Mbps connection speed.

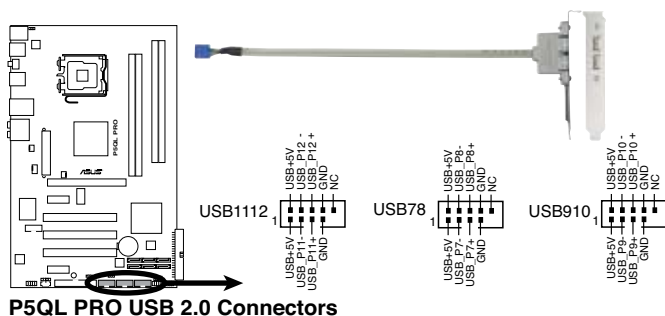

Never connect a 1394 cable to the USB connectors. Doing so will damage the motherboard!



You can connect the front panel USB cable to the ASUS Q-Connector (USB, blue) first, and then install the Q-Connector (USB) to the USB connector onboard if your chassis supports front panel USB ports.



The USB module cable is purchased separately.

6. Optical drive audio connector (4-pin CD)

These connectors allow you to receive stereo audio input from sound sources such as a CD-ROM, TV tuner, or MPEG card.

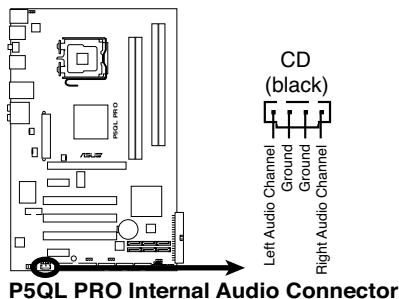

7. CPU, chassis, and power fan connectors (4-pin CPU_FAN, 3-pin CHA_FAN, 3-pin PWR_FAN)

The fan connectors support cooling fans of 350 mA~2000 mA (24 W max.) or a total of 1 A~7 A (84 W max.) at +12V. Connect the fan cables to the fan connectors on the motherboard, making sure that the black wire of each cable matches the ground pin of the connector.



Do not forget to connect the fan cables to the fan connectors. Insufficient air flow inside the system may damage the motherboard components. These are not jumpers! Do not place jumper caps on the fan connectors!

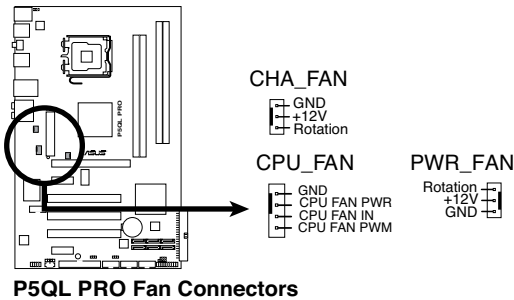

Only the CPU_FAN connector supports the ASUS Q-FAN feature.

8. Serial port connector (10-1 pin COM1)

This connector is for a serial (COM) port. Connect the serial port module cable to this connector, then install the module to a slot opening at the back of the system chassis.

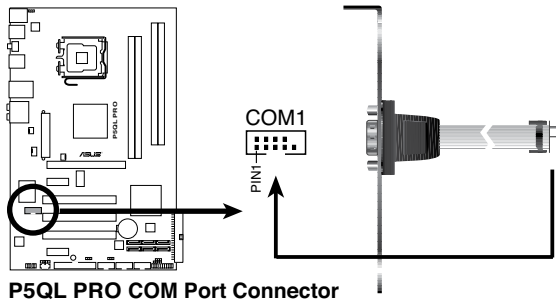

The serial port module is purchased separately.

9. Chassis intrusion connector (4-1 pin CHASSIS)

This connector is for a chassis-mounted intrusion detection sensor or switch. Connect one end of the chassis intrusion sensor or switch cable to this connector. The chassis intrusion sensor or switch sends a high-level signal to this connector when a chassis component is removed or replaced. The signal is then generated as a chassis intrusion event.

By default, the pin labeled “Chassis Signal” and “Ground” are shorted with a jumper cap. Remove the jumper caps only when you intend to use the chassis intrusion detection feature.

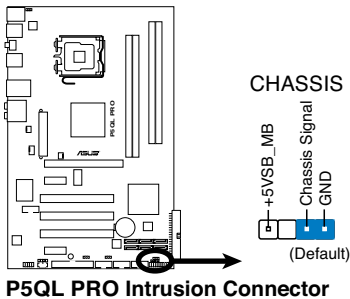

10. Front panel audio connector (10-1 pin AAFP)

This connector is for a chassis-mounted front panel audio I/O module that supports either HD Audio or legacy AC`97 audio standard. Connect one end of the front panel audio I/O module cable to this connector.

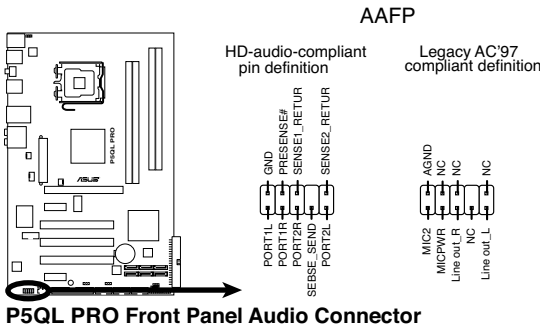

- We recommend that you connect a high-definition front panel audio module to this connector to avail of the motherboard's high-definition audio capability.
- If you want to connect a high-definition front panel audio module to this connector, set the **Front Panel Type** item in the BIOS setup to **[HD Audio]**; if you want to connect an AC'97 front panel audio module to this connector, set the item to **[AC97]**. By default, this connector is set to **[HD Audio]**. See section 4.5.3 **Onboard Devices Configuration** for details.

11. ATX power connectors (24-pin EATXPWR, 4-pin EATX12V)

These connectors are for ATX power supply plugs. The power supply plugs are designed to fit these connectors in only one orientation. Find the proper orientation and push down firmly until the connectors completely fit.

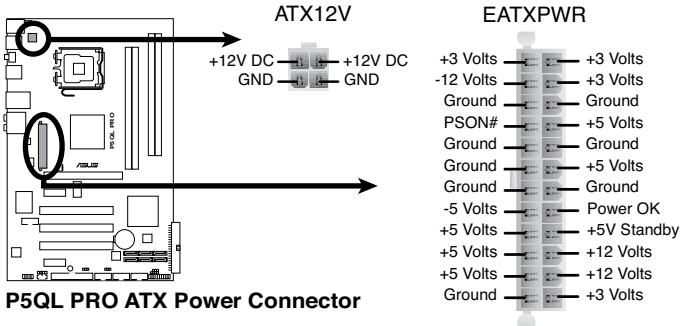

- For a fully configured system, we recommend that you use a power supply unit (PSU) that complies with ATX 12 V Specification 2.0 (or later version) and provides a minimum power of 400 W.
- Do not forget to connect the 4-pin EATX12V power plug; otherwise, the system will not boot.
- Use of a PSU with a higher power output is recommended when configuring a system with more power-consuming devices. The system may become unstable or may not boot up if the power is inadequate.
- The ATX 12 V Specification 2.0-compliant (400W) PSU has been tested to support the motherboard power requirements with the following configuration:
 - CPU: Intel® Pentium® Extreme 3.73GHz
 - Memory: 512 MB DDR2 (x4)
 - Graphics card: ASUS EAX1900XT
 - Parallel ATA device: IDE hard disk drive
 - Serial ATA device: SATA hard disk drive (x2)
 - Optical drive: DVD-RW

12. System panel connector (20-8 pin PANEL)

This connector supports several chassis-mounted functions.

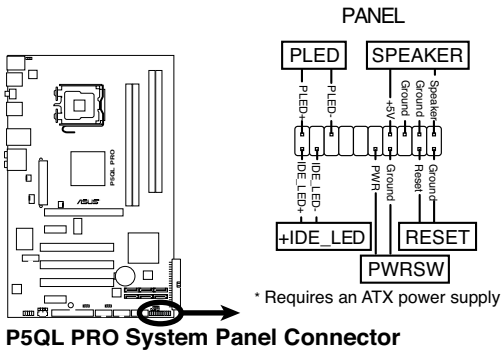

- **System power LED (2-pin PLED)**

This 2-pin connector is for the system power LED. Connect the chassis power LED cable to this connector. The system power LED lights up when you turn on the system power, and blinks when the system is in sleep mode.

- **Hard disk drive activity LED (2-pin IDE_LED)**

This 2-pin connector is for the HDD Activity LED. Connect the HDD Activity LED cable to this connector. The IDE LED lights up or flashes when data is read from or written to the HDD.

- **System warning speaker (4-pin SPEAKER)**

This 4-pin connector is for the chassis-mounted system warning speaker. The speaker allows you to hear system beeps and warnings.

- **ATX power button/soft-off button (2-pin PWRSW)**

This connector is for the system power button. Pressing the power button turns the system on or puts the system in sleep or soft-off mode depending on the BIOS settings. Pressing the power switch for more than four seconds while the system is ON turns the system OFF.

- **Reset button (2-pin RESET)**

This 2-pin connector is for the chassis-mounted reset button for system reboot without turning off the system power.

Q-Connector (system panel)

You can use ASUS Q-Connector to connect / disconnect chassis front panel cables by only a few steps. Directions below shows how to install ASUS Q-Connector.

Step1.

Connect correct front panel to ASUS Q-Connector first. You can refer to the marking on Q-Connector itself to know the detail pin definition.

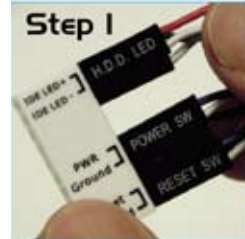

Step2.

Properly install the ASUS Q-Connector to the System panel connector.



Step3.

Front panel functions are enabled.



A series of horizontal lines for writing.

This chapter describes the power up sequence, the vocal POST messages, and ways of shutting down the system.

Powering up **3**

3.1	Starting up for the first time.....	3-1
3.2	Turning off the computer.....	3-2

3.1 Starting up for the first time

1. After making all the connections, replace the system case cover.
2. Ensure that all switches are off.
3. Connect the power cord to the power connector at the back of the system chassis.
4. Connect the power cord to a power outlet that is equipped with a surge protector.
5. Turn on the devices in the following order:
 - a. Monitor
 - b. External SCSI devices (starting with the last device on the chain)
 - c. System power
6. After applying power, the system power LED on the system front panel case lights up. For systems with ATX power supplies, the system LED lights up when you press the ATX power button. If your monitor complies with “green” standards or if it has a “power standby” feature, the monitor LED may light up or switch between orange and green after the system LED turns on.

The system then runs the power-on self tests or POST. While the tests are running, the BIOS beeps (see BIOS beep codes table below) or additional messages appear on the screen. If you do not see anything within 30 seconds from the time you turned on the power, the system may have failed a power-on self test. Check the jumper settings and connections or call your retailer for assistance.

AMI BIOS beep codes

BIOS Beep	Description
One short beep	VGA detected Quick boot set to disabled No keyboard detected
One continuous beep followed by two short beeps then a pause (repeated)	No memory detected
One continuous beep followed by three short beeps	No VGA detected
One continuous beep followed by four short beeps	Hardware component failure

7. At power on, hold down the **<Delete>** key to enter the BIOS Setup. Follow the instructions in Chapter 4.

3.2 Turning off the computer

3.2.1 Using the OS shut down function

If you are using Windows® XP:

1. Click the **Start** button then select **Turn Off Computer**.
2. Click the **Turn Off** button to shut down the computer.
3. The power supply should turn off after Windows® shuts down.

If you are using Windows® Vista:

1. Click the **Start** button then select **ShutDown**.
2. The power supply should turn off after Windows® shuts down.

3.2.2 Using the dual function power switch

While the system is ON, pressing the power switch for less than four seconds puts the system to sleep mode or to soft-off mode, depending on the BIOS setting. Pressing the power switch for more than four seconds lets the system enter the soft-off mode regardless of the BIOS setting. Refer to section “4.5 Power Menu” for details.

This chapter tells how to change the system settings through the BIOS Setup menus. Detailed descriptions of the BIOS parameters are also provided.

BIOS setup 4

4.1	Managing and updating your BIOS	4-1
4.2	BIOS setup program	4-10
4.3	Main menu	4-13
4.4	Ai Tweaker menu	4-17
4.5	Advanced menu	4-22
4.6	Power menu	4-28
4.7	Boot menu	4-31
4.8	Tools menu	4-36
4.9	Exit menu	4-40

4.1 Managing and updating your BIOS

The following utilities allow you to manage and update the motherboard Basic Input/Output System (BIOS) setup.

1. **ASUS Update:** Updates the BIOS in Windows® environment.
2. **ASUS EZ Flash 2:** Updates the BIOS in DOS mode using a floppy disk or a USB flash disk.
3. **ASUS AFUDOS:** Updates the BIOS in DOS mode using a bootable floppy disk.
4. **ASUS CrashFree BIOS 3:** Updates the BIOS using a bootable floppy disk, a USB flash disk or the motherboard support DVD when the BIOS file fails or gets corrupted.

Refer to the corresponding sections for details on these utilities.



Save a copy of the original motherboard BIOS file to a bootable floppy disk or a USB flash disk in case you need to restore the BIOS in the future. Copy the original motherboard BIOS using the ASUS Update or AFUDOS utilities.

4.1.1 ASUS Update utility

The ASUS Update is a utility that allows you to manage, save, and update the motherboard BIOS in Windows® environment. The ASUS Update utility allows you to:

- Save the current BIOS file
- Download the latest BIOS file from the Internet
- Update the BIOS from an updated BIOS file
- Update the BIOS directly from the Internet, and
- View the BIOS version information.

This utility is available in the support DVD that comes with the motherboard package.



ASUS Update requires an Internet connection either through a network or an Internet Service Provider (ISP).

Installing ASUS Update

To install ASUS Update:

1. Place the support DVD in the optical drive. The **Drivers** menu appears.
2. Click the **Utilities** tab, then click **Install ASUS Update**.
3. The ASUS Update utility is copied to your system.



Quit all Windows® applications before you update the BIOS using this utility.

Updating the BIOS through the Internet

To update the BIOS through the Internet:

1. Launch the ASUS Update utility from the Windows® desktop by clicking **Start > Programs > ASUS > ASUSUpdate > ASUSUpdate**. The ASUS Update main window appears.

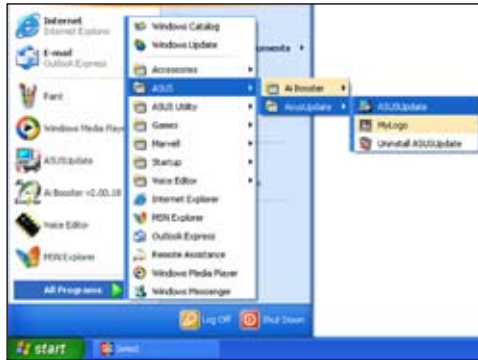

2. Select **Update BIOS from the Internet** option from the drop-down menu, then click **Next**.
3. Select the ASUS FTP site nearest you to avoid network traffic, or click **Auto Select**. Click **Next**.

- From the FTP site, select the BIOS version that you wish to download. Click **Next**.
- Follow the screen instructions to complete the update process.



The ASUS Update utility is capable of updating itself through the Internet. Always update the utility to avail all its features.



Updating the BIOS through a BIOS file

To update the BIOS through a BIOS file:

- Launch the ASUS Update utility from the Windows® desktop by clicking **Start > Programs > ASUS > ASUSUpdate > ASUSUpdate**. The ASUS Update main window appears.
- Select **Update BIOS from a file** option from the drop-down menu, then click **Next**.



- Locate the BIOS file from the **Open** window, then click **Open**.
- Follow the screen instructions to complete the update process.

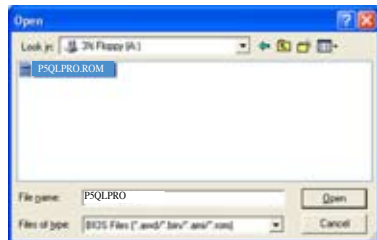

4.1.2 Creating a bootable floppy disk

1. Do any one of the following to create a bootable floppy disk.

DOS environment

- a. Insert a 1.44MB floppy disk into the drive.
- b. At the DOS prompt, type `format A: /s` then press **<Enter>**.

Windows® XP environment

- a. Insert a 1.44 MB floppy disk to the floppy disk drive.
- b. Click **Start** from the Windows® desktop, then select **My Computer**.
- c. Select the 3 1/2 Floppy Drive icon.
- d. Click **File** from the menu, then select **Format**. A **Format 3 1/2 Floppy Disk** window appears.
- e. Select **Create an MS-DOS startup disk** from the format options field, then click **Start**.

Windows® Vista environment

- a. Insert a formatted, high density 1.44 MB floppy disk to the floppy disk drive.
 - b. Click  from the Windows® desktop, then select **Computer**.
 - c. Right-click Floppy Disk Drive then click **Format** to display the Format 3 1/2 Floppy dialog box.
 - d. Select the **Create an MS-DOS startup disk** check box.
 - e. Click **Start**.
2. Copy the original or the latest motherboard BIOS file to the bootable floppy disk.

4.1.3 ASUS EZ Flash 2 utility

The ASUS EZ Flash 2 feature allows you to update the BIOS without having to go through the long process of booting from a floppy disk and using a DOS-based utility. The EZ Flash 2 utility is built-in the BIOS chip so it is accessible by pressing **<Alt> + <F2>** during the Power-On Self Tests (POST).

To update the BIOS using EZ Flash 2:

1. Visit the ASUS website at www.asus.com to download the latest BIOS file for the motherboard.
2. Save the BIOS file to a floppy disk or a USB flash disk, then restart the system.
3. You can launch the EZ Flash 2 in two ways.
 - (1) Insert the floppy disk / USB flash disk that contains the BIOS file to the floppy disk drive or the USB port.

Press **<Alt> + <F2>** during POST to display the following.

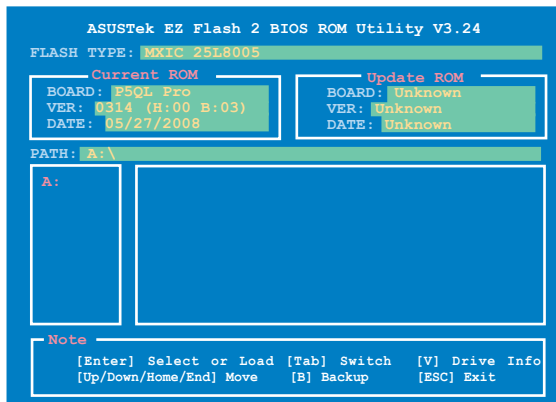

- (2) Enter BIOS setup program. Go to the **Tools** menu to select **EZ Flash 2** and press **<Enter>** to enable it.

You can switch between drives by pressing **<Tab>** before the correct file is found. Then press **<Enter>**.

4. When the correct BIOS file is found, EZ Flash 2 performs the BIOS update process and automatically reboots the system when done.



- This function can support devices such as USB flash disk, or floppy disk with **FAT 32/16** format and single partition only.
- Do not shut down or reset the system while updating the BIOS to prevent system boot failure!

4.1.4 AFUDOS utility

The AFUDOS utility allows you to update the BIOS file in DOS environment using a bootable floppy disk with the updated BIOS file. This utility also allows you to copy the current BIOS file that you can use as backup when the BIOS fails or gets corrupted during the updating process.

Copying the current BIOS

To copy the current BIOS file using the AFUDOS utility:



- Make sure that the floppy disk is not write-protected and has at least 1024KB free space to save the file.
- The succeeding BIOS screens are for reference only. The actual BIOS screen displays may not be the same as shown.

1. Copy the AFUDOS utility (afudos.exe) from the motherboard support DVD to the bootable floppy disk you created earlier.
2. Boot the system in DOS mode, then at the prompt type:

```
afudos /o[filename]
```

where the [filename] is any user-assigned filename not more than eight alphanumeric characters for the main filename and three alphanumeric characters for the extension name.

```
A:\>afudos /oOLDBIOS1.rom
```

Main filename Extension name

3. Press **<Enter>**. The utility copies the current BIOS file to the floppy disk.

```
A:\>afudos /oOLDBIOS1.rom
AMI Firmware Update Utility - Version 1.19 (ASUS V2.07(03.11.24BB))
Copyright (C) 2002 American Megatrends, Inc. All rights reserved.
  Reading flash ..... done
  Write to file..... ok
A:\>
```

The utility returns to the DOS prompt after copying the current BIOS file.

Updating the BIOS file

To update the BIOS file using the AFUDOS utility:

1. Visit the ASUS website (www.asus.com) and download the latest BIOS file for the motherboard. Save the BIOS file to a bootable floppy disk.



Write the BIOS filename on a piece of paper. You need to type the exact BIOS filename at the DOS prompt.

2. Copy the AFUDOS utility (afudos.exe) from the motherboard support DVD to the bootable floppy disk you created earlier.
3. Boot the system in DOS mode, then at the prompt type:

```
afudos /i [filename]
```

where [filename] is the latest or the original BIOS file on the bootable floppy disk.

```
A:\>afudos /iP5QLPRO.ROM
```

4. The utility verifies the file and starts updating the BIOS.

```
A:\>afudos /iP5QLPRO.ROM
AMI Firmware Update Utility - Version 1.19 (ASUS V2.07(03.11.24BB))
Copyright (C) 2002 American Megatrends, Inc. All rights reserved.

WARNING!! Do not turn off power during flash BIOS
Reading file ..... done
Reading flash ..... done

Advance Check .....
Erasing flash ..... done
Writing flash ..... 0x0008CC00 (9%)
```



Do not shut down or reset the system while updating the BIOS to prevent system boot failure!

5. The utility returns to the DOS prompt after the BIOS update process is completed. Reboot the system from the hard disk drive.

```
A:\>afudos /iP5QLPRO.ROM
AMI Firmware Update Utility - Version 1.19 (ASUS V2.07(03.11.24BB))
Copyright (C) 2002 American Megatrends, Inc. All rights reserved.

WARNING!! Do not turn off power during flash BIOS
Reading file ..... done
Reading flash ..... done

Advance Check .....
Erasing flash ..... done
Writing flash ..... done
Verifying flash .... done

Please restart your computer

A:\>
```

4.1.5 ASUS CrashFree BIOS 3 utility

The ASUS CrashFree BIOS 3 is an auto recovery tool that allows you to restore the BIOS file when it fails or gets corrupted during the updating process. You can update a corrupted BIOS file using the motherboard support DVD, a floppy disk or a USB flash disk that contains the updated BIOS file.



- Prepare the motherboard support DVD, the floppy disk or the USB flash disk containing the updated motherboard BIOS before using this utility.
- For the P5QL PRO motherboard, this utility will not function when you use a PATA optical drive.
- Always connect the SATA cable to the SATA1 / SATA 2 connector; otherwise, the utility will not function.

Recovering the BIOS from a floppy disk

To recover the BIOS from a floppy disk:

1. Turn on the system.
2. Insert the floppy disk with the original or updated BIOS file to the floppy disk drive.
3. The utility displays the following message and automatically checks the floppy disk for the original or updated BIOS file.

```
Bad BIOS checksum. Starting BIOS recovery...
Checking for floppy...
```

When found, the utility reads the BIOS file and starts flashing the corrupted BIOS file.

```
Bad BIOS checksum. Starting BIOS recovery...
Checking for floppy...
Floppy found!
Reading file "P5QLPRO.ROM". Completed.
Start flashing...
```



DO NOT shut down or reset the system while updating the BIOS! Doing so can cause system boot failure!

4. Restart the system after the utility completes the updating process.

Recovering the BIOS from the support DVD

To recover the BIOS from the support DVD:

1. Turn on the system.
2. Insert the motherboard support DVD to the optical drive.
3. The utility displays the following message and automatically checks the DVD for the BIOS file.

```
Bad BIOS checksum. Starting BIOS recovery...
Checking for floppy...
```

When no floppy disk is found, the utility automatically checks the optical drive for the original or updated BIOS file. The utility then updates the corrupted BIOS file.

```
Bad BIOS checksum. Starting BIOS recovery...
Checking for floppy...
Floppy not found!
Checking for DVD-ROM...
DVD-ROM found!
Reading file "P5QLPRO.ROM". Completed.
Start flashing...
```

4. Restart the system after the utility completes the updating process.



The recovered BIOS may not be the latest BIOS version for this motherboard. Visit the ASUS website (www.asus.com) to download the latest BIOS file.

Recovering the BIOS from a USB flash disk

To recover the BIOS from a USB flash disk:

1. Insert a USB flash disk that contains BIOS file to the USB port.
2. Turn on the system.
3. The utility will automatically checks the devices for the BIOS file. When found, the utility reads the BIOS file and starts flashing the corrupted BIOS file.
4. Restart the system after the utility completes the updating process.



- Only the USB flash disk with FAT 32/16 format and single partition can support ASUS CrashFree BIOS 3. The device size should be smaller than 8GB.
 - DO NOT shut down or reset the system while updating the BIOS! Doing so can cause system boot failure!
-

4.2 BIOS setup program

This motherboard supports a programmable Serial Peripheral Interface (SPI) chip that you can update using the provided utility described in section “4.1 Managing and updating your BIOS.”

Use the BIOS Setup program when you are installing a motherboard, reconfiguring your system, or prompted to “Run Setup.” This section explains how to configure your system using this utility.

Even if you are not prompted to use the Setup program, you can change the configuration of your computer in the future. For example, you can enable the security password feature or change the power management settings. This requires you to reconfigure your system using the BIOS Setup program so that the computer can recognize these changes and record them in the CMOS RAM of the SPI chip.

The SPI chip on the motherboard stores the Setup utility. When you start up the computer, the system provides you with the opportunity to run this program. Press **** during the Power-On Self-Test (POST) to enter the Setup utility; otherwise, POST continues with its test routines.

If you wish to enter Setup after POST, reboot the system by doing any of the following procedures:

- Restart using the OS standard shut-down procedure.
- Press **<Ctrl>+<Alt>+** simultaneously.
- Press the reset button on the system chassis.
- Press the power button to turn the system off then back on.



Using the **power button**, **reset button**, or the **<Ctrl>+<Alt>+** keys to force reset from a running operating system can cause damage to your data or system. We recommend to always shut-down the system properly from the operating system.

The Setup program is designed to make it as easy to use as possible. Being a menu-driven program, it lets you scroll through the various sub-menus and make your selections from the available options using the navigation keys.



-
- The default BIOS settings for this motherboard apply for most conditions to ensure optimum performance. If the system becomes unstable after changing any BIOS settings, load the default settings to ensure system compatibility and stability. Select the **Load Setups Default** item under the Exit Menu. See section **4.9 Exit Menu**.
 - The BIOS setup screens shown in this section are for reference purposes only, and may not exactly match what you see on your screen.
 - Visit the ASUS website (www.asus.com) to download the latest BIOS file for this motherboard.
-

4.2.1 BIOS menu screen

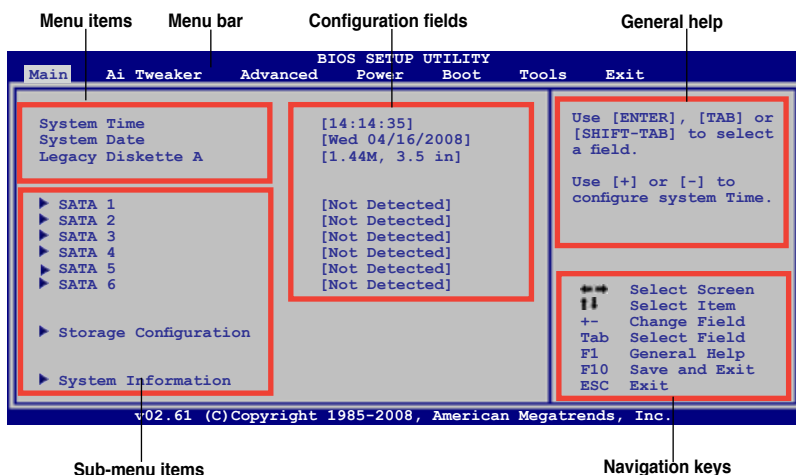

4.2.2 Menu bar

The menu bar on top of the screen has the following main items:

- | | |
|-------------------|--|
| Main | For changing the basic system configuration |
| Ai Tweaker | For configuring system performance settings |
| Advanced | For changing the advanced system settings |
| Power | For changing the advanced power management (APM) configuration |
| Boot | For changing the system boot configuration |
| Tools | For configuring options for special functions |
| Exit | For selecting the exit options and loading default settings. |

To select an item on the menu bar, press the right or left arrow key on the keyboard until the desired item is highlighted.

4.2.3 Navigation keys

At the bottom right corner of a menu screen are the navigation keys for that particular menu. Use the navigation keys to select items in the menu and change the settings.



Some of the navigation keys differ from one screen to another.

4.2.4 Menu items

The highlighted item on the menu bar displays the specific items for that menu. For example, selecting Main shows the Main menu items.

The other items (Ai Tweaker, Advanced, Power, Boot, and Exit) on the menu bar have their respective menu items.

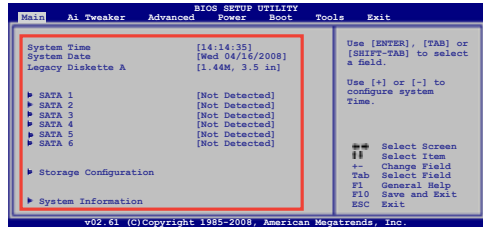

Main menu items

4.2.5 Sub-menu items

A solid triangle before each item on any menu screen means that the item has a sub-menu. To display the sub-menu, select the item and press <Enter>.

4.2.6 Configuration fields

These fields show the values for the menu items. If an item is user-configurable, you can change the value of the field opposite the item. You cannot select an item that is not user-configurable.

A configurable field is enclosed in brackets, and is highlighted when selected. To change the value of a field, select it then press <Enter> to display a list of options. Refer to "4.2.7 Pop-up window."

4.2.7 Pop-up window

Select a menu item then press <Enter> to display a pop-up window with the configuration options for that item.

4.2.8 Scroll bar

A scroll bar appears on the right side of a menu screen when there are items that do not fit on the screen. Press the <Up> / <Down> arrow keys or <Page Up> / <Page Down> keys to display the other items on the screen.

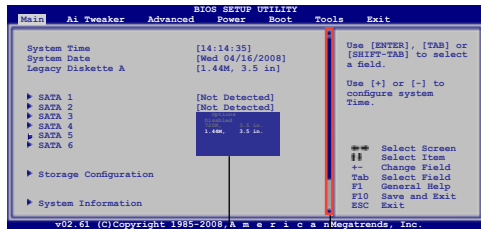

Pop-up window

Scroll bar

4.2.9 General help

At the top right corner of the menu screen is a brief description of the selected item.

4.3 Main menu

When you enter the BIOS Setup program, the Main menu screen appears, giving you an overview of the basic system information.



Refer to section **4.2.1 BIOS menu screen** for information on the menu screen items and how to navigate through them.

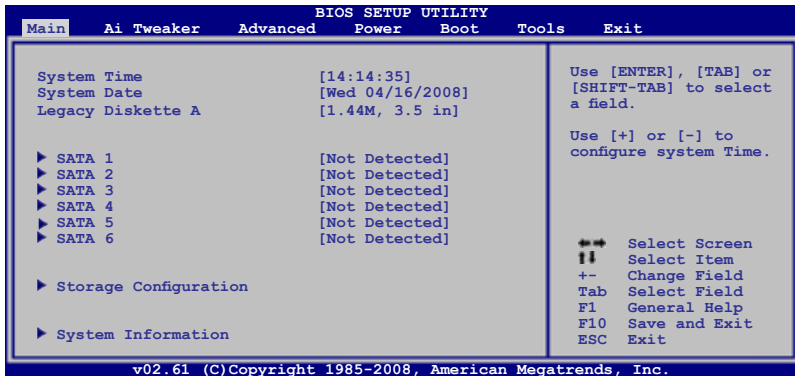

4.3.1 System Time [xx:xx:xx]

Allows you to set the system time.

4.3.2 System Date [Day xx/xx/xxxx]

Allows you to set the system date.

4.3.3 Legacy Diskette A [1.44M, 3.5 in.]

Sets the type of floppy drive installed.

Configuration options: [Disabled] [720K, 3.5 in.] [1.44M, 3.5 in.]

4.3.4 SATA 1~6

While entering Setup, the BIOS automatically detects the presence of IDE devices. There is a separate sub-menu for each IDE device. Select a device item then press <Enter> to display the IDE device information.

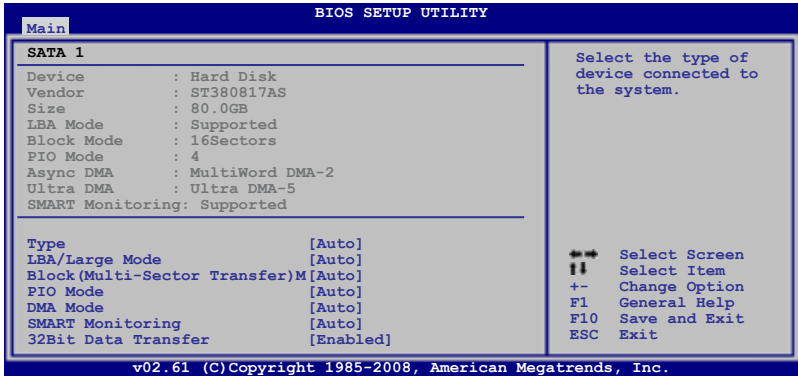

The BIOS automatically detects the values opposite the dimmed items (Device, Vendor, Size, LBA Mode, Block Mode, PIO Mode, Async DMA, Ultra DMA, and SMART Monitoring). These values are not user-configurable. These items show **NA** if no IDE device is installed in the system.

Type [Auto]

Selects the type of IDE drive. Setting to [Auto] allows automatic selection of the appropriate IDE device type. Select [CDROM] if you are specifically configuring a CD-ROM drive. Select [ARMD] (ATAPI Removable Media Device) if your device is either a ZIP, LS-120, or MO drive.

Configuration options: [Not Installed] [Auto] [CDROM] [ARMD]

LBA/Large Mode [Auto]

Enables or disables the LBA mode. Setting to [Auto] enables the LBA mode if the device supports this mode, and if the device was not previously formatted with LBA mode disabled. Configuration options: [Disabled] [Auto]

Block (Multi-sector Transfer) M [Auto]

Enables or disables data multi-sectors transfers. When set to [Auto], the data transfer from and to the device occurs multiple sectors at a time if the device supports multi-sector transfer feature. When set to [Disabled], the data transfer from and to the device occurs one sector at a time.

Configuration options: [Disabled] [Auto]

PIO Mode [Auto]

Selects the PIO mode.

Configuration options: [Auto] [0] [1] [2] [3] [4]

DMA Mode [Auto]

Selects the DMA mode. Configuration options: [Auto]

SMART Monitoring [Auto]

Sets the Smart Monitoring, Analysis, and Reporting Technology.
Configuration options: [Auto] [Disabled] [Enabled]

32Bit Data Transfer [Enabled]

Enables or disables 32-bit data transfer.
Configuration options: [Disabled] [Enabled]

4.3.5 Storage Configuration

The items in this menu allow you to set or change the configurations for the SATA devices installed in the system. Select an item then press <Enter> if you want to configure the item.

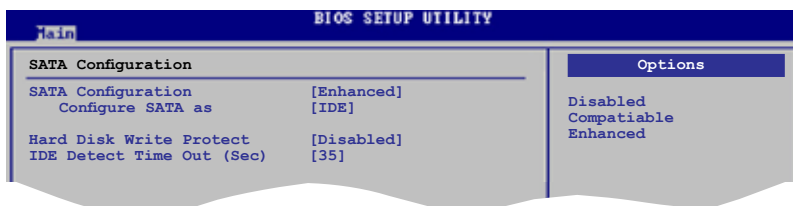

SATA Configuration [Enhanced]

Configuration options: [Disabled] [Compatible] [Enhanced]

Configure SATA as [IDE]

Sets the configuration for the Serial ATA connectors supported by the Southbridge chip. Configuration options: [IDE] [AHCI]



Due to Intel chipset driver support regulation, the AHCI mode is not supported in Windows XP environment. The AHCI mode is only supported by Windows Vista with OS built-in driver.

Hard Disk Write Protect [Disabled]

Disables or enables device write protection. This will be effective only if device is accessed through BIOS. Configuration option: [Disabled] [Enabled]

IDE Detect Time Out (Sec) [35]

Selects the time out value for detecting ATA/ATAPI devices.
Configuration options: [0] [5] [10] [15] [20] [25] [30] [35]

4.3.6 System Information

This menu gives you an overview of the general system specifications. The BIOS automatically detects the items in this menu.

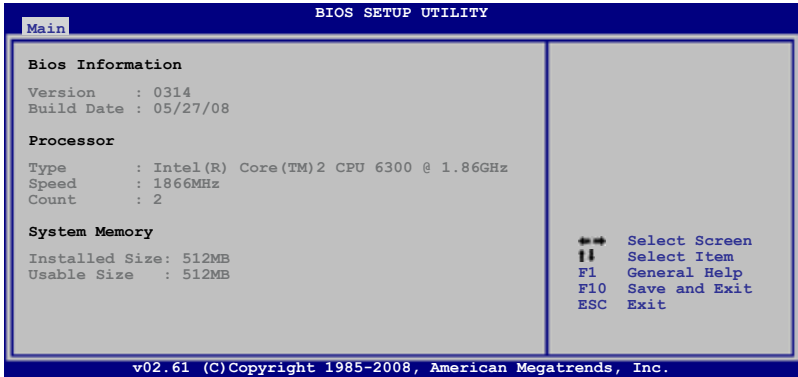

AMI BIOS

Displays the auto-detected BIOS information.

Processor

Displays the auto-detected CPU specification.

System Memory

Displays the auto-detected system memory.

4.4 Ai Tweaker menu

The **Ai Tweaker** menu items allow you to configure system performance settings. Select an item then press **<Enter>** to display the configuration options.



Take caution when changing the settings of the Extreme Tweaker menu items. Incorrect field values can cause the system to malfunction.

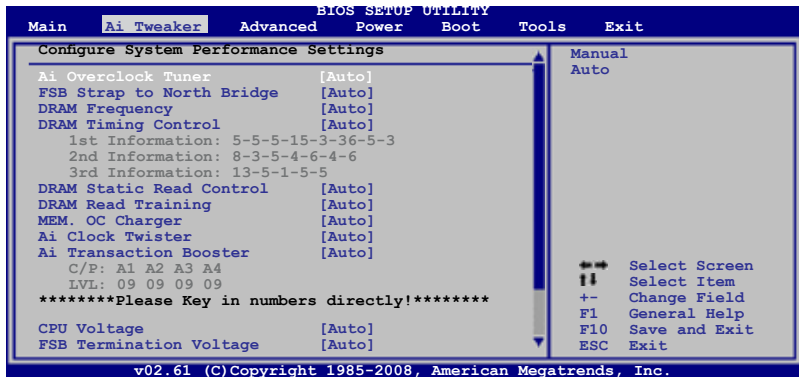

Scroll down to display the following items:

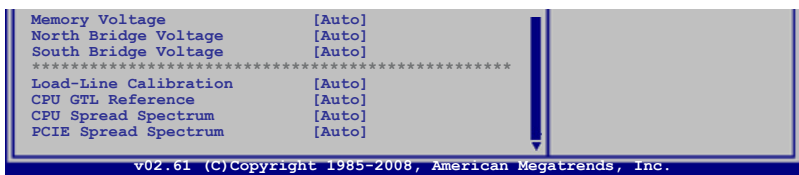

Ai Overclock Tuner [Auto]

Allows selection of CPU overclocking options to achieve desired CPU internal frequency. Select either one of the preset overclocking configuration options:

Manual - allows you to individually set overclocking parameters.

Auto - loads the optimal settings for the system.



The follow items appear only when you set the **[Ai Overclock Tuner]** item to **[Manual]**.

FSB Frequency [xxx]

Displays the frequency sent by the clock generator to the system bus and PCI bus. Use the <+> and <-> keys to adjust the FSB frequency. You can also type the desired FSB frequency using the numeric keypad. The values range from 200 to 800. Refer to the table below for the correct Front Side Bus and CPU External Frequency settings.

FSB / CPU External Frequency Synchronization

Front Side Bus	CPU External Frequency
FSB 1600	400 MHz
FSB 1333	333 MHz
FSB 1066	266 MHz
FSB 800	200 MHz

PCIe Frequency [XXX]

Use the <+> and <-> keys to adjust the PCIe frequency. You can also type the desired PCIe frequency using the numeric keypad. The values range from 100 to 180.

FSB Strap to North Bridge [Auto]

Allows you to adjust the FSB strap. Configuration options: [Auto] [200MHz] [266MHz] [333MHz] [400MHz]

DRAM Frequency [Auto]

Allows you to set the DDR2 operating frequency. Configuration options: [Auto] [DDR2-533MHz] [DDR2-639MHz] [DDR2-667MHz] [DDR2-709MHz] [DDR2-800MHz] [DDR2-852MHz] [DDR2-887MHz] [DDR2-1066MHz]



Selecting a very high DRAM frequency may cause the system to become unstable! If this happens, revert to the default setting.

DRAM Timing Control [Auto]

Allows selection of the DRAM timing configuration. Configuration options: [Auto] [Manual]



- The following items appear only when you set the **[DRAM Timing Control]** item to **[Manual]**.
 - The configuration options for some of the following items vary depending on the DIMMs you install on the motherboard.
-

1st Information: 5-5-5-15-3-36-5-3

CAS# Latency [5 DRAM Clocks]

Configuration options: [3 DRAM Clocks] ~ [11 DRAM Clocks]

DRAM RAS# to CAS# Delay [5 DRAM Clocks]

Configuration options: [3 DRAM Clocks] ~ [18 DRAM Clocks]

DRAM RAS# Precharge [5 DRAM Clocks]

Configuration options: [3 DRAM Clocks] ~ [18 DRAM Clocks]

DRAM RAS# Activate to Precha [15 DRAM Clocks]

Configuration options: [3 DRAM Clocks] ~ [18 DRAM Clocks]

RAS# to RAS# Delay [Auto]

Configuration options: [Auto] [1 DRAM Clocks] ~ [15 DRAM Clocks]

Row Refresh Cycle Time [Auto]

Configuration options: [Auto] [20 DRAM Clocks] [25 DRAM Clocks]
[30 DRAM Clocks] [35 DRAM Clocks] [42 DRAM Clocks]

Write Recovery Time [Auto]

Configuration options: [Auto] [1 DRAM Clocks] ~ [15 DRAM Clocks]

Read to Precharge Time [Auto]

Configuration options: [Auto] [1 DRAM Clocks] ~ [15 DRAM Clocks]

2nd Information: 8-3-5-4-6-4-6

READ to WRITE Delay (S/D) [Auto]

Configuration options: [Auto] [1 DRAM Clocks] ~ [15 DRAM Clocks]

WRITE to READ Delay (S) [Auto]

Configuration options: [Auto] [1 DRAM Clocks] ~ [15 DRAM Clocks]

WRITE to READ Delay (D) [Auto]

Configuration options: [Auto] [1 DRAM Clocks] ~ [15 DRAM Clocks]

READ to READ Delay (S) [Auto]

Configuration options: [Auto] [1 DRAM Clocks] ~ [15 DRAM Clocks]

READ to READ Delay (D) [Auto]

Configuration options: [Auto] [1 DRAM Clocks] ~ [15 DRAM Clocks]

WRITE to WRITE Delay (S) [Auto]

Configuration options: [Auto] [1 DRAM Clocks] ~ [15 DRAM Clocks]

WRITE to WRITE Delay (D) [Auto]

Configuration options: [Auto] [1 DRAM Clocks] ~ [15 DRAM Clocks]

3rd Information: 13-5-1-5-5

WRITE to PRE Delay [Auto]

Configuration options: [Auto] [1 DRAM Clocks] ~ [15 DRAM Clocks]

READ to PRE Delay [Auto]

Configuration options: [Auto] [1 DRAM Clocks] ~ [15 DRAM Clocks]

PRE to PRE Delay [Auto]

Configuration options: [Auto] [1 DRAM Clocks] ~ [3 DRAM Clocks]

ALL PRE to ACT Delay [Auto]

Configuration options: [Auto] [1 DRAM Clocks] ~ [15 DRAM Clocks]

ALL PRE to REF Delay [Auto]

Configuration options: [Auto] [1 DRAM Clocks] ~ [15 DRAM Clocks]

DRAM Static Read Control [Auto]

Adjusting this item might enhance DRAM overclocking ability.

Configuration options: [Auto] [Disabled] [Enabled]

DRAM Read Training [Auto]

Adjusting this item might enhance DRAM overclocking ability.

Configuration options: [Auto] [Disabled] [Enabled]

MEM. OC Charger [Auto]

Adjusting this item might enhance DRAM overclocking ability.

Configuration options: [Auto] [Disabled] [Enabled]

Ai Clock Twister [Auto]

Allows you to set the DRAM performance. Set this item to **[Light]** or **[Lighter]** to enhance DRAM compatibility, or **[Strong]** or **[Stronger]** to accelerate DRAM performance.

Configuration options: [Auto] [Lighter] [Light] [Moderate] [Strong] [Stronger]

Ai Transaction Booster [Auto]

Allows you to set the system performance.

Configuration options: [Auto] [Manual]



The following two sub-items appear only when you set the **Ai Transaction Booster** item to **[Manual]**.

C/P: B1 b2 B3 B4

LVL: 09 09 09 09

Common Performance Level [05]

Set this item to a higher level for better compatibility or a lower level for better performance. Use the <+> and <-> keys to adjust the value.

Pull-In of CHA/B PH1/2/3/4 [Disabled]

Set this item to **[Enabled]** to apply enhancement on DRAM Channel A and B, Phase 1 to 4. The number of phases is determined by DRAM frequency and FSB strap. Configuration options: [Disabled] [Enabled]

CPU Voltage [Auto]

Allows you to set the CPU VCore voltage. The values range from 0.8500V to 1.6000V with a 0.00625V interval. Configuration options: [Auto]



Refer to the CPU documentation before setting the CPU Vcore voltage. Setting a high VCore voltage may damage the CPU permanently, and setting a low VCore voltage may make the system unstable.

FSB Termination Voltage [Auto]

Allows you to set the front side bus termination voltage. The values range from 1.20V* to 1.50V with a 0.10V interval.



The minimum and standard values become 1.10V when 45nm CPU is detected.

Memory Voltage [Auto]

Allows you to set the memory voltage manually or **Auto**. Use the <+> and <-> keys to adjust the value. Configuration options: [Auto]

North Bridge Voltage [Auto]

Allows you to set the NB voltage manually or **Auto**. Use the <+> and <-> keys to adjust the value. Configuration options: [Auto]



Setting a very high voltage may damage the component permanently, and setting a very low voltage may cause the system to become unstable.

South Bridge Voltage [Auto]

Allows you to set the SB voltage. The values range from 1.50V to 1.70V with a 0.20V interval. Configuration options: [Auto]

Load-Line Calibration [Auto]

Allows you to select the CPU Load-Line mode. Set to **[Disabled]** to follow Intel specifications, or to **[Enabled]** to improve CPU VDrop directly. Configuration options: [Auto] [Disabled] [Enabled]

CPU GTL Reference [Auto]

Allows you to set the CPU GTL voltage reference. Configuration options: [Auto] [0.667x] [0.65x] [0.63x] [0.615x]

CPU Spread Spectrum [Auto]

Allows you to set the CPU spread spectrum. Configuration options: [Auto]
[Disabled]

PCIe Spread Spectrum [Auto]

Allows you to set the PCIe spread spectrum. Configuration options: [Auto]
[Disabled]

4.5 Advanced menu

The **Advanced** menu items allow you to change the settings for the CPU and other system devices.



Take caution when changing the settings of the Advanced menu items. Incorrect field values can cause the system to malfunction.

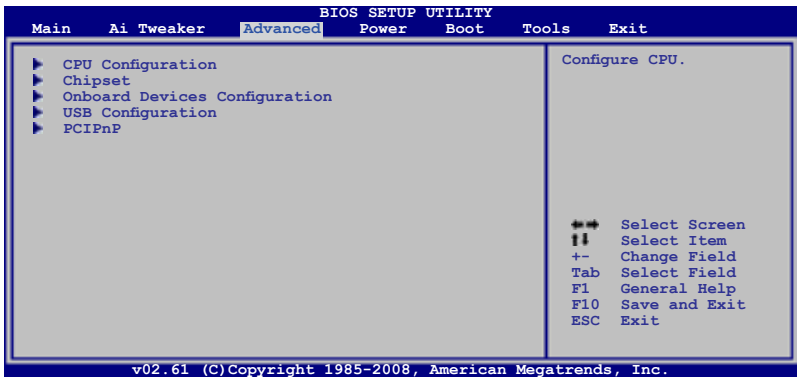

4.5.1 CPU Configuration

The items in this menu show the CPU-related information that the BIOS automatically detects.

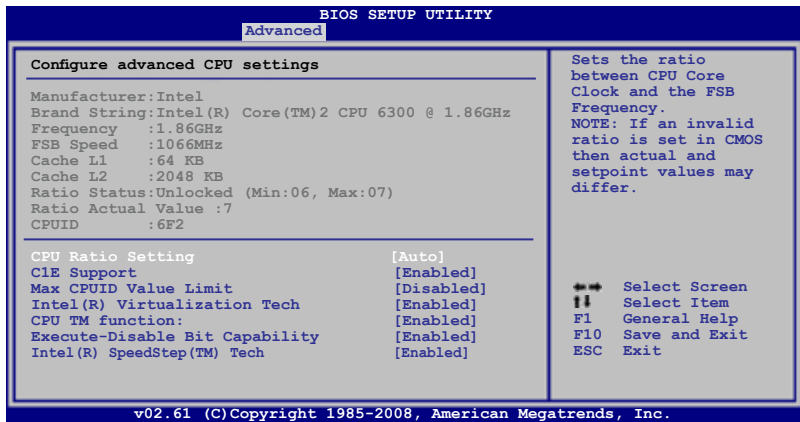

CPU Ratio Setting [Auto]

Sets the ration between CPU core clock and the FSB frequency.

Configuration options: [Auto]



If an invalid ratio is set in CMOS then actual and setpoint values my differ.



Key in ratio numbers directly.

C1E Support [Enabled]

Allows you to enable or disable C1E Support.

Configuration options: [Disabled] [Enabled]

Max CPUID Value Limit [Disabled]

Setting this item to [Enabled] allows legacy operating systems to boot even without support for CPUs with extended CPUID functions.

Configuration options: [Disabled] [Enabled]

Intel® Virtualization Technology [Enabled]

Enables or disables Intel® Virtualization Technology. Virtualization enhanced by Intel® Virtualization Technology allows a platform to run multiple operating systems and applications in independent partitons. With virtualization, one computer system can function as multiple virtual systems. Configuration options: [Enabled] [Disabled]

CPU TM function [Enabled]

Enables or disables Intel® CPU Thermal Monitor (TM) function, a CPU overheating protection function. When enabled, the CPU core frequency and voltage are reduced when the CPU overheats. Configuration options: [Disabled] [Enabled]

Execute-Disable Bit Capability [Enabled]

Allows you to enable or disable the No-Execution Page Protection Technology. Setting this item to [Disabled] forces the XD feature flag to always return to zero (0). Configuration options: [Disabled] [Enabled]



The following item appears only when you installed an Intel® Pentium® 4 or later CPU that supports the Enhanced Intel SpeedStep® Technology (EIST).

Intel® SpeedStep™ Technology [Enabled]

Allows you to use the Enhanced Intel® SpeedStep® Technology. When set to [Enabled], you can adjust the system power settings in the operating system to use the EIST feature. Set this item to [Disabled] if you do not want to use the EIST. Configuration options: [Enabled] [Disabled]

4.5.2 Chipset

The Chipset menu allows you to change the advanced chipset settings. Select an item then press <Enter> to display the sub-menu.

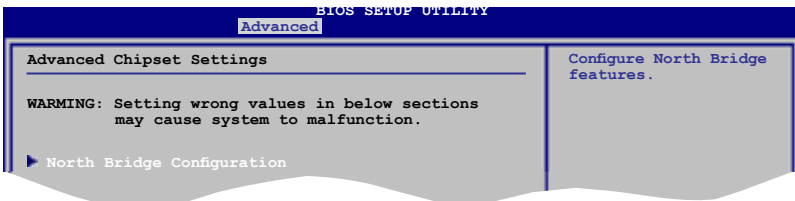

North Bridge Configuration

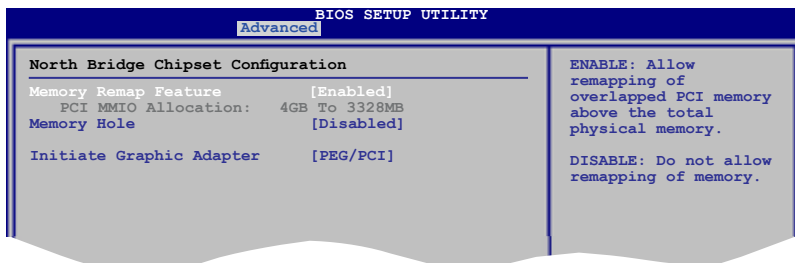

Memory Remap Feature [Enabled]

Allows you to enable or disable the remapping of the overlapped PCI memory above the total physical memory. Enable this option only when you install 64-bit operating system. Configuration options: [Disabled] [Enabled]

Memory Hole [Disabled]

Allows you to configure the memory hole. Configuration options: [Disabled] [15MB-16MB]

Initiate Graphic Adapter [PEG/PCI]

Allows you to decide which graphics controller to use as the primary boot device. Configuration options: [PCI/PEG] [PEG/PCI]

4.5.3 Onboard Devices Configuration

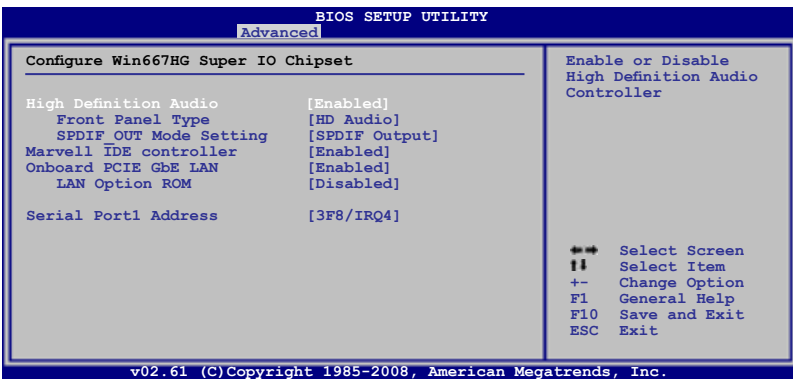

High Definition Audio [Enabled]

Allows you to enable or disable the High Definition Audio. The following item appears only when you enable this item.

Configuration options: [Enabled] [Disabled]

Front Panel Type [HD Audio]

Allows you to set the front panel audio connector (AAFP) mode to legacy AC'97 or high-definition audio depending on the audio standard that the front panel audio module supports. Configuration options: [AC97] [HD Audio]

SPDIF_OUT Mode Setting [SPDIF Output]

Allows you to set the SPDIF_OUT mode. Configuration options: [HDMI Output] [SPDIF Output]

Marvell IDE controller [Enabled]

Allows you to disable or enable the onboard Marvell® IDE controller.

Configuration options: [Enabled] [Disabled]

Onboard PCIE GbE LAN [Enabled]

Configuration options: [Enabled] [Disabled]

LAN Option ROM [Disabled]

This item appears only when you enable the previous item.

Configuration options: [Disabled] [Enabled]

Serial Port1 Address [3F8/IRQ4]

Allows you to select the Serial Port1 base address.

Configuration options: [Disabled] [3F8/IRQ4] [2F8/IRQ3] [3E8/IRQ4] [2E8/IRQ3]

4.5.4 USB Configuration

The items in this menu allows you to change the USB-related features. Select an item then press **<Enter>** to display the configuration options.

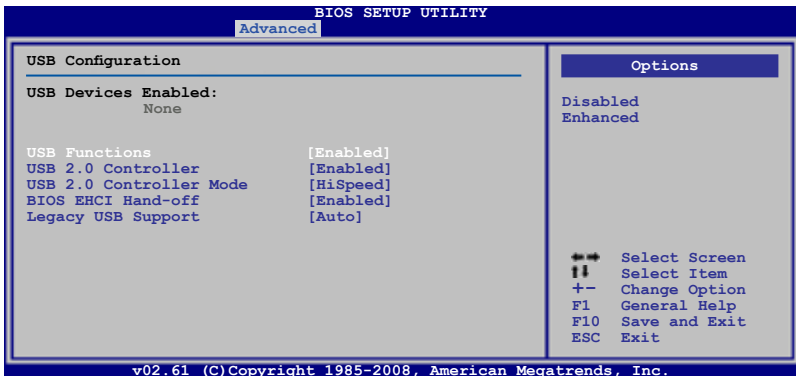

The **USB Devices Enabled** item shows auto-detected values. If no USB device is detected, the item shows **None**.

USB Functions [Enabled]

Allows you to enable or disable the USB functions.

Configuration options: [Disabled] [Enabled]

USB 2.0 Controller [Enabled]

Allows you to enable or disable the USB 2.0 controller.

Configuration options: [Enabled] [Disabled]

USB 2.0 Controller Mode [HiSpeed]

Allows you to set the USB 2.0 controller mode to HiSpeed (480 Mbps) or FullSpeed (12 Mbps). This item appears only when you enable the USB 2.0 Controller item. Configuration options: [FullSpeed] [HiSpeed]

BIOS EHCI Hand-off [Enabled]

Allows you to enable support for operating systems without an EHCI hand-off feature. Configuration options: [Disabled] [Enabled]

Legacy USB Support [Auto]

Allows you to enable or disable support for legacy USB devices. Setting to **[Auto]** allows the system to detect the presence of USB devices at startup. If detected, the USB controller legacy mode is enabled. If no USB device is detected, the legacy USB support is disabled. Configuration options: [Disabled] [Enabled] [Auto]

4.5.5 PCI PnP

The **PCI PnP** menu items allow you to change the advanced settings for PCI/PnP devices.



Take caution when changing the settings of the PCI PnP menu items. Incorrect field values can cause the system to malfunction.

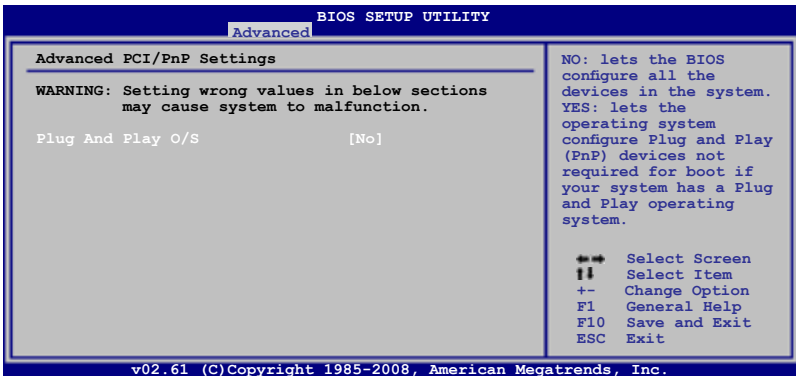

Plug And Play O/S [No]

When set to **[No]**, BIOS configures all the devices in the system. When set to **[Yes]** and if you install a Plug and Play operating system, the operating system configures the Plug and Play devices not required for boot.

Configuration options: [No] [Yes]

4.6 Power menu

The Power menu items allow you to change the settings for the Advanced Power Management (APM). Select an item then press <Enter> to display the configuration options.

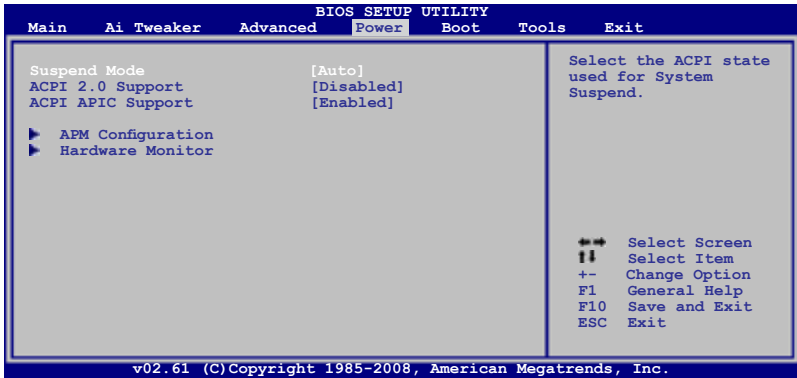

4.6.1 Suspend Mode [Auto]

Allows you to select the Advanced Configuration and Power Interface (ACPI) state to be used for system suspend. Configuration options: [S1 (POS) Only] [S3 Only] [Auto]

[S1(POS) Only] - Enables the system to enter the ACPI S1 (Power on Suspend) sleep state. In S1 sleep state, the system appears suspended and stays in a low power mode. The system can be resumed at any time.

[S3 Only] - Enables the system to enter the ACPI S3 (Suspend to RAM) sleep state (default). In S3 sleep state, the system appears to be off and consumes less power than in the S1 state. When signaled by a wake-up device or event, the system resumes to its working state exactly where it was left off.

[Auto] - Detected by OS.

4.6.2 ACPI 2.0 Support [Disabled]

Allows you to add more tables for Advanced Configuration and Power Interface (ACPI) 2.0 specifications. Configuration options: [Disabled] [Enabled]

4.6.3 ACPI APIC Support [Enabled]

Allows you to enable or disable the Advanced Configuration and Power Interface (ACPI) support in the Advanced Programmable Interrupt Controller (APIC). When set to **Enabled**, the ACPI APIC table pointer is included in the RSDT pointer list. Configuration options: [Disabled] [Enabled]

4.6.4 APM Configuration

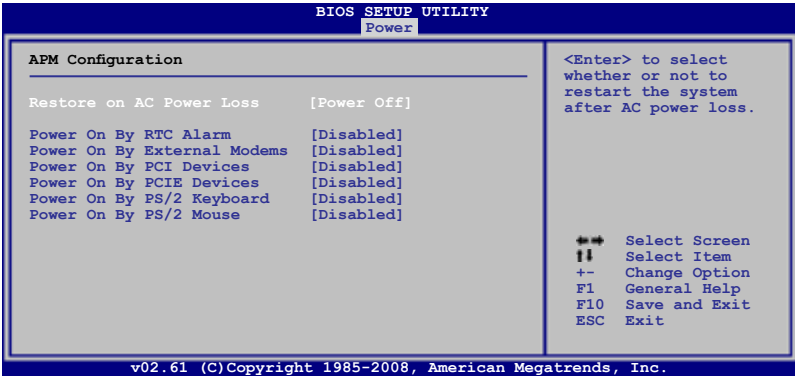

Restore On AC Power Loss [Power Off]

When set to **Power Off**, the system goes into off state after an AC power loss. When set to **Power On**, the system goes on after an AC power loss. When set to **Last State**, the system goes into either off or on state, whatever the system state was before the AC power loss.

Configuration options: [Power Off] [Power On] [Last State]

Power On By RTC Alarm [Disabled]

Allows you to enable or disable RTC to generate a wake event. When this item is set to **Enabled**, the items RTC Alarm Date/ RTC Alarm Hour/ RTC Alarm Minute/ RTC Alarm Second will become user-configurable with set values.

Configuration options: [Disabled] [Enabled]

Power On By External Modems [Disabled]

This allows either settings of **[Enabled]** or **[Disabled]** for powering up the computer when the external modem receives a call while the computer is in Soft-off mode. Configuration options: [Disabled] [Enabled]



The computer cannot receive or transmit data until the computer and applications are fully running. Thus, connection cannot be made on the first try. Turning an external modem off and then back on while the computer is off causes an initialization string that turns the system power on.

Power On By PCI Devices [Disabled]

Allows you to enable or disable the PME to wake up from S5 by PCI devices. Configuration options: [Disabled] [Enabled]

Power On By PCIE Devices [Disabled]

Allows you to enable or disable the PCIE devices to generate a wake event. Configuration options: [Disabled] [Enabled]

Power On By PS/2 Keyboard [Disabled]

Allows you to disable the Power On by PS/2 keyboard function or set specific keys on the PS/2 keyboard to turn on the system. This feature requires an ATX power supply that provides at least 1A on the +5VSB lead.

Configuration options: [Disabled] [Space Bar] [Ctrl-Esc] [Power Key]

Power On By PS/2 Mouse [Disabled]

When set to [Enabled], this parameter allows you to use the PS/2 mouse to turn on the system. This feature requires an ATX power supply that provides at least 1A on the +5VSB lead. Configuration options: [Disabled] [Enabled]

4.6.5 Hardware Monitor

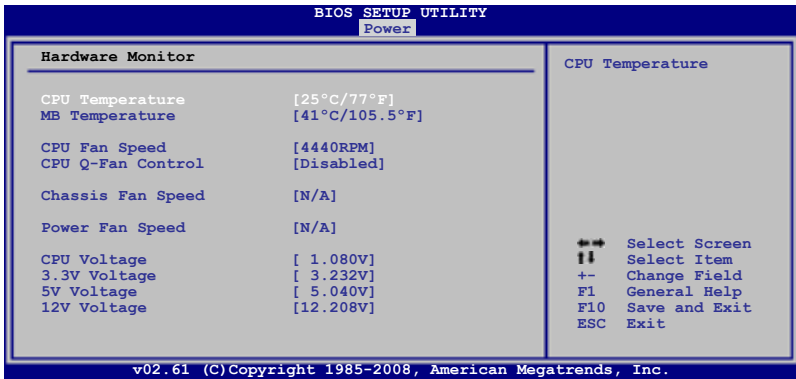

CPU Temperature [xxx°C/xxx°F]

MB Temperature [xxx°C/xxx°F]

The onboard hardware monitor automatically detects and displays the motherboard and CPU temperatures. Select [Ignored] if you do not wish to display the detected temperatures.

CPU Fan Speed [xxxxRPM] or [Ignored]

The onboard hardware monitor automatically detects and displays the CPU fan speed in rotations per minute (RPM). If the fan is not connected to the motherboard, the field shows *N/A*.

CPU Q-Fan Control [Disabled]

Allows you to enable or disable the CPU Q-Fan controller.

Configuration options: [Disabled] [Enabled]



The **CPU Fan Profile** item appears when you enable the CPU Q-Fan Control feature.

CPU Fan Profile [Standard]

Allows you to set the appropriate performance level of the CPU Q-Fan.
Configuration options: [Standard] [Silent] [Turbo]

Chassis Fan Speed [xxxxRPM] or [Ignored] / [N/A]

The onboard hardware monitor automatically detects and displays the chassis fan speed in rotations per minute (RPM). If the fan is not connected to the motherboard, the field shows **N/A**.

Power Fan Speed [xxxxRPM] or [Ignored] / [N/A]

The onboard hardware monitor automatically detects and displays the power fan speed in rotations per minute (RPM). If the fan is not connected to the motherboard, the field shows **N/A**.

CPU Voltage, 3.3V Voltage, 5V Voltage, 12V Voltage [xxxxV] or [Ignored]

The onboard hardware monitor automatically detects the voltage output through the onboard voltage regulators. Select **[Ignored]** if you do not want to detect this item.

4.7 Boot menu

The **Boot** menu items allow you to change the system boot options. Select an item then press **<Enter>** to display the sub-menu.

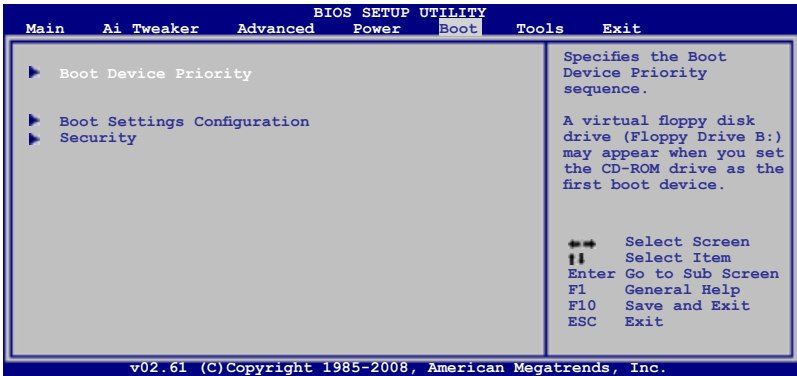

4.7.1 Boot Device Priority

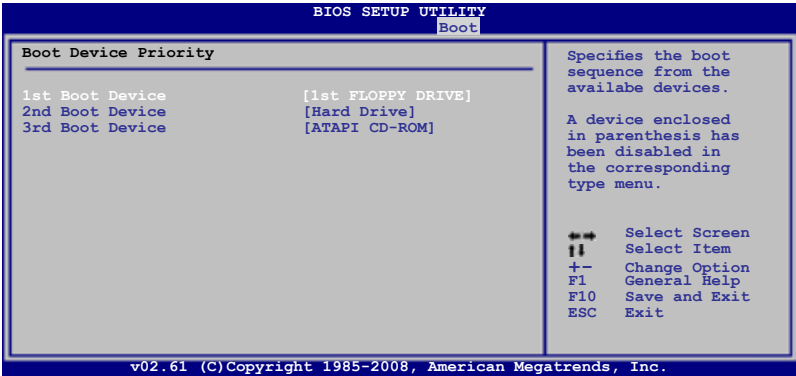

1st ~ xxth Boot Device

These items specify the boot device priority sequence from the available devices. The number of device items that appears on the screen depends on the number of devices installed in the system.

Configuration options: [1st FLOPPY DRIVE] [Hard Drive]
[ATAPI CD-ROM] [Disabled]

4.7.2 Boot Settings Configuration

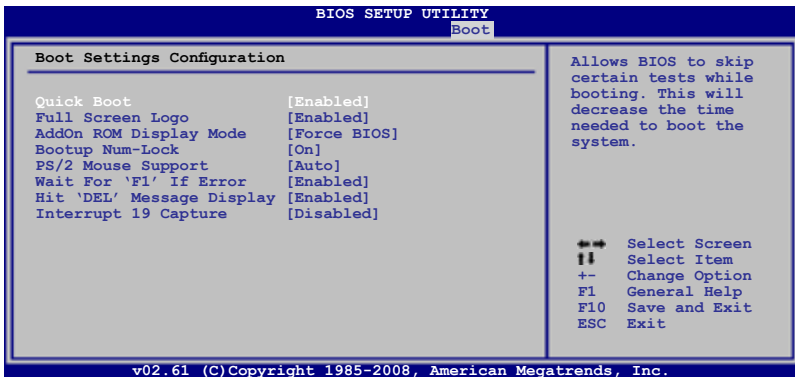

Quick Boot [Enabled]

Enabling this item allows the BIOS to skip some power on self tests (POST) while booting to decrease the time needed to boot the system. When set to [Disabled], BIOS performs all the POST items.

Configuration options: [Disabled] [Enabled]

Full Screen Logo [Enabled]

This allows you to enable or disable the full screen logo display feature.

Configuration options: [Disabled] [Enabled]



Set this item to **[Enabled]** to use the ASUS MyLogo2™ feature.

AddOn ROM Display Mode [Force BIOS]

Sets the display mode for option ROM.

Configuration options: [Force BIOS] [Keep Current]

Bootup Num-Lock [On]

Allows you to select the power-on state for the NumLock.

Configuration options: [Off] [On]

PS/2 Mouse Support [Auto]

Allows you to enable or disable support for PS/2 mouse.

Configuration options: [Disabled] [Enabled] [Auto]

Wait For 'F1' If Error [Enabled]

When set to **Enabled**, the system waits for the F1 key to be pressed when error occurs. Configuration options: [Disabled] [Enabled]

Hit 'DEL' Message Display [Enabled]

When set to **Enabled**, the system displays the message **Press DEL to run Setup** during POST. Configuration options: [Disabled] [Enabled]

Interrupt 19 Capture [Disabled]

When set to **[Enabled]**, this function allows the option ROMs to trap Interrupt 19. Configuration options: [Disabled] [Enabled]

4.7.3 Security

The Security menu items allow you to change the system security settings. Select an item then press **<Enter>** to display the configuration options.

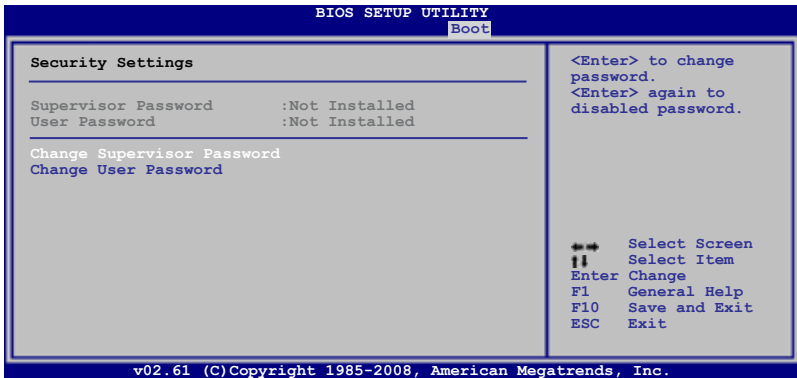

Change Supervisor Password

Select this item to set or change the supervisor password. The **Supervisor Password** item on top of the screen shows the default **Not Installed**. After you set a password, this item shows **Installed**.

To set a Supervisor Password:

1. Select the **Change Supervisor Password** item and press **<Enter>**.
2. From the password box, type a password composed of at least six letters and/or numbers, then press **<Enter>**.
3. Confirm the password when prompted.

The message **"Password Installed"** appears after you successfully set your password.

To change the supervisor password, follow the same steps as in setting a supervisor password.

To clear the supervisor password, select the **Change Supervisor Password** then press **<Enter>**. The message **"Password uninstalled"** appears.



If you forget your BIOS password, you can clear it by erasing the CMOS Real Time Clock (RTC) RAM. See section “1.9 Jumpers” for information on how to erase the RTC RAM.

After you have set a supervisor password, the other items appear to allow you to change other security settings.

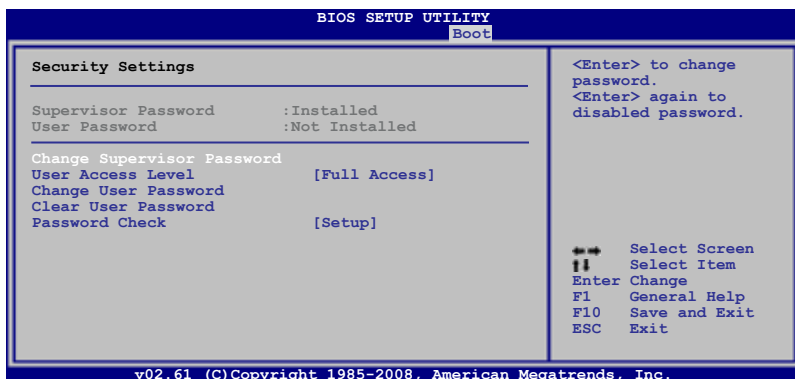

User Access Level [Full Access]

This item allows you to select the access restriction to the Setup items. Configuration options: [No Access] [View Only] [Limited] [Full Access]

No Access prevents user access to the Setup utility.

View Only allows access but does not allow change to any field.

Limited allows changes only to selected fields, such as Date and Time.

Full Access allows viewing and changing all the fields in the Setup utility.

Change User Password

Select this item to set or change the user password. The **User Password** item on top of the screen shows the default **Not Installed**. After you set a password, this item shows **Installed**.

To set a User Password:

1. Select the **Change User Password** item and press **<Enter>**.
2. On the password box that appears, type a password composed of at least six letters and/or numbers, then press **<Enter>**.
3. Confirm the password when prompted.

The message “**Password Installed**” appears after you set your password successfully.

To change the user password, follow the same steps as in setting a user password.

Clear User Password

Select this item to clear the user password.

Password Check [Setup]

When set to **[Setup]**, BIOS checks for user password when accessing the Setup utility. When set to **[Always]**, BIOS checks for user password both when accessing Setup and booting the system. Configuration options: [Setup] [Always]

4.8 Tools menu

The Tools menu items allow you to configure options for special functions. Select an item then press **<Enter>** to display the sub-menu.

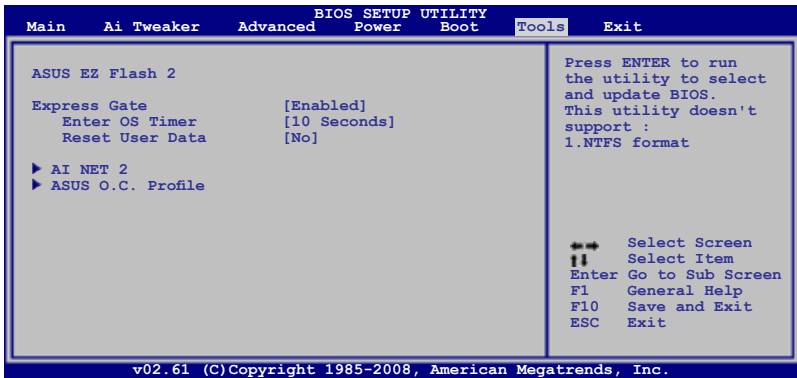

4.8.1 ASUS EZ Flash 2

Allows you to run ASUS EZ Flash 2. When you press **<Enter>**, a confirmation message appears. Use the left/right arrow key to select between **[Yes]** or **[No]**, then press **<Enter>** to confirm your choice. Please see section 4.1.3 for details.

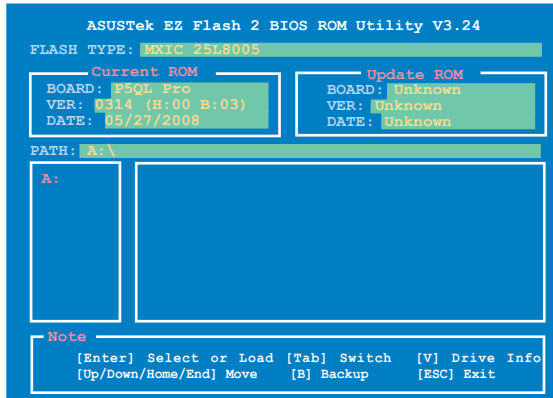

4.8.2 Express Gate [Enabled]

Allows you to enable or disable the ASUS Express Gate feature. The ASUS Express Gate feature is a unique instant-on environment that provides quick access to the Internet browser and Skype. Configuration options: [Enabled] [Disabled]

Enter OS Timer [10 Seconds]

Sets countdown duration that the system waits at the Express Gate's first screen before starting Windows or other installed OS. Choose **[Prompt User]** to stay at the first screen of Express Gate for user action.

Configuration options: [Prompt User] [1 second] [3 seconds] [5 seconds] [10 seconds] [15 seconds] [20 seconds] [30 seconds]

Reset User Data [No]

Allows you to clear Express Gate's user data.

Configuration options: [No] [Reset]

When setting this item to **[Reset]**, make sure to save the setting to the BIOS so that the user data will be cleared the next time you enter the Express Gate. User data includes the Express Gate's settings as well as any personal information stored by the web browser (bookmarks, cookies, browsing history, etc.). This is useful in the rare case where corrupt settings prevent the Express Gate environment from launching properly.



The first time wizard will run again when you enter the Express Gate environment after clearing its settings.

4.8.3 AI NET 2

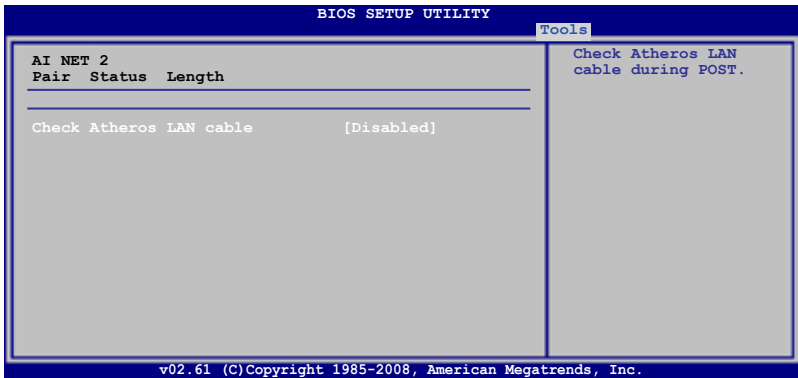

Check Atheros LAN cable [Disabled]

Enables or disables checking of the Atheros LAN cable during the Power-On Self-Test (POST).

Configuration options: [Disabled] [Enabled]

4.8.4 ASUS O.C. Profile

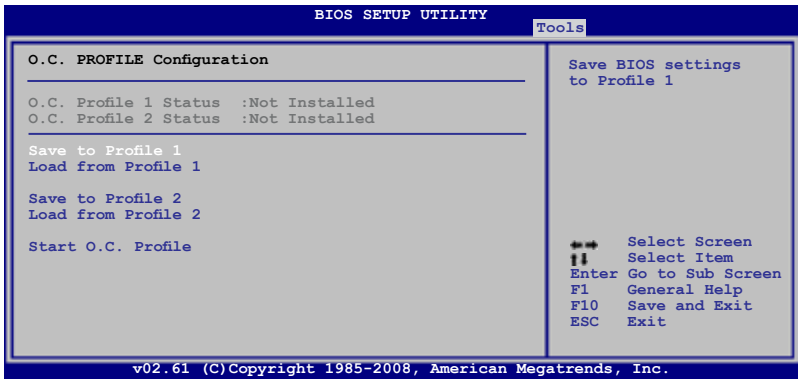

Save to Profile 1/2

Allows you to save the current BIOS file to the BIOS Flash. Press **<Enter>** to save the file.

Load from Profile 1/2

Allows you to load the previous BIOS settings saved in the BIOS Flash. Press **<Enter>** to load the file.

Start O.C. Profile

Allows you to run the utility to save and load CMOS. Press **<Enter>** to run the utility.

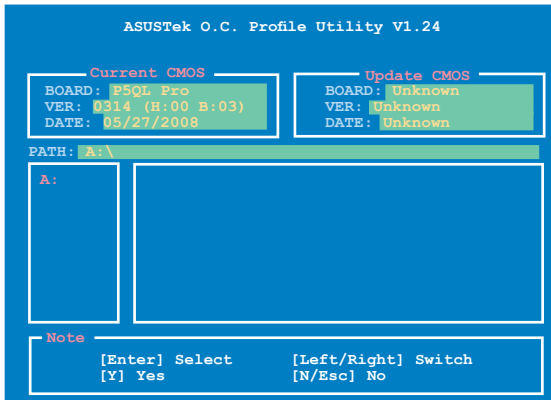

- This function can support devices such as USB flash disk or floppy disk with FAT 32/16 format and single partition only.
- DO NOT shut down or reset the system while updating the BIOS to prevent the system boot failure!

4.9 Exit menu

The Exit menu items allow you to load the optimal or failsafe default values for the BIOS items, and save or discard your changes to the BIOS items.

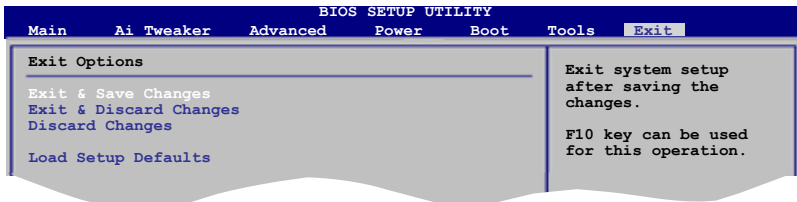

Pressing **<Esc>** does not immediately exit this menu. Select one of the options from this menu or **<F10>** from the legend bar to exit.

Exit & Save Changes

Once you are finished making your selections, choose this option from the Exit menu to ensure the values you selected are saved to the CMOS RAM. An onboard backup battery sustains the CMOS RAM so it stays on even when the PC is turned off. When you select this option, a confirmation window appears. Select **OK** to save changes and exit.



If you attempt to exit the Setup program without saving your changes, the program prompts you with a message asking if you want to save your changes before exiting. Press **<Enter>** to save the changes while exiting.

Exit & Discard Changes

Select this option only if you do not want to save the changes that you made to the Setup program. If you made changes to fields other than System Date, System Time, and Password, the BIOS asks for a confirmation before exiting.

Discard Changes

This option allows you to discard the selections you made and restore the previously saved values. After selecting this option, a confirmation appears. Select **OK** to discard any changes and load the previously saved values.

Load Setup Defaults

This option allows you to load the default values for each of the parameters on the Setup menus. When you select this option or if you press **<F5>**, a confirmation window appears. Select **OK** to load default values. Select **Exit & Save Changes** or make other changes before saving the values to the non-volatile RAM.

This chapter describes the contents of the support CD that comes with the motherboard package.

5 Software support

5.1	Installing an operating system	5-1
5.2	Support DVD information	5-1
5.3	Software information	5-10

5.1 Installing an operating system

This motherboard supports Windows® XP/Vista operating systems (OS). Always install the latest OS version and corresponding updates to maximize the features of your hardware.



- Motherboard settings and hardware options vary. Use the setup procedures presented in this chapter for reference only. Refer to your OS documentation for detailed information.
- Ensure that you install the Windows® XP Service Pack2 or later versions before installing the drivers for better compatibility and system stability.

5.2 Support DVD information

The support DVD that came with the motherboard package contains the drivers, software applications, and utilities that you can install to avail all motherboard features.



The contents of the support DVD are subject to change at any time without notice. Visit the ASUS website at www.asus.com for updates.

5.2.1 Running the support DVD

Place the support DVD to the optical drive. The DVD automatically displays the **Drivers** menu if Autorun is enabled in your computer.



Click an icon to display support DVD/motherboard information

Click an item to install



If Autorun is NOT enabled in your computer, browse the contents of the support DVD to locate the file ASSETUP.EXE from the BIN folder. Double-click the ASSETUP.EXE to run the DVD.

5.2.2 Drivers menu

The **Drivers** menu shows the available device drivers if the system detects installed devices. Install the necessary drivers to activate the devices.



ASUS InstAll - Installation Wizard for Drivers

Installs the ASUS InstAll - Installation wizard for drivers.

Intel Chipset Inf Update Program

Installs the Intel® chipset Inf update program.

Atheros AR8121/AR8113/AR8114 PCI-E Ethernet Controller

Installs the Atheros AR8121/AR8113/AR8114 PCI-E Ethernet controller.

Realtek Audio Driver

Installs the Realtek® ALC1200 audio driver and application.

ASUS EPU-4 Engine

Installs the ASUS EPU-4 Engine.

5.2.3 Utilities menu

The **Utilities** menu shows the applications and other software that the motherboard supports.



ASUS InstAll - Installation Wizard for Utilities

Installs all of the utilities through the Installation Wizard.

ASUS Update

The ASUS Update utility allows you to update the motherboard BIOS in a Windows® environment. This utility requires an Internet connection either through a network or an Internet Service Provider (ISP).

ASUS PC Probe II

This smart utility monitors the fan speed, CPU temperature, and system voltages, and alerts you of any detected problems. This utility helps you keep your computer in healthy operating condition.

ASUS AI Suite

Installs the ASUS AI Suite.

Adobe Acrobat Reader 8

Installs the Adobe® Acrobat® Reader that allows you to open, view, and print documents in Portable Document Format (PDF).

Microsoft DirectX 9.0c

Installs the Microsoft® DirectX 9.0c driver. The Microsoft DirectX® 9.0c is a multimedia technology that enhances computer graphics and sound. DirectX® improves the multimedia features of your computer so you can enjoy watching TV and movies, capturing videos, or playing games in your computer. Visit the Microsoft website at <http://www.microsoft.com> for updates.

Corel MediaOne Starter

Installs the Corel MediaOne Starter.

CyberLink PowerBackup

Install the CyberLink PowerBackup.

ASUS Express Gate Installer

Launches the ASUS Express Gate application.

Atheros Ethernet Utility

Installs the Atheros Ethernet utility.



Click  to show the rest of the utilities under the **Utilities** menu.



WinZip 11

Installs the WinZip 11 application.

Ulead Burn.Now

Installs the Ulead Burn.Now application.

Ulead PhotoImpact 12 SE

Installs the Ulead PhotoImpact 12 SE application.

Anti-Virus Utility

Installs the anti-virus application that detects and protects your computer from viruses that destroy data.

Anti-Virus Utility Download

Installs the anti-virus utility download application.

5.2.4 Manual menu

The **Manual** menu contains a list of supplementary user manuals. Click an item to open the folder of the user manual.



Most user manual files are in Portable Document Format (PDF). Install the Adobe® Acrobat® Reader from the **Utilities** menu before opening a user manual file.



Realtek HD Audio User's Manual

Allows you to open the Realtek HD Audio User Manual.

ASUS Motherboard Installation Guide

Allows you to open the ASUS Motherboard Installation Guide.

5.2.5 ASUS Contact information

Click the **Contact** tab to display the ASUS contact information. You can also find this information on the inside front cover of this user guide.

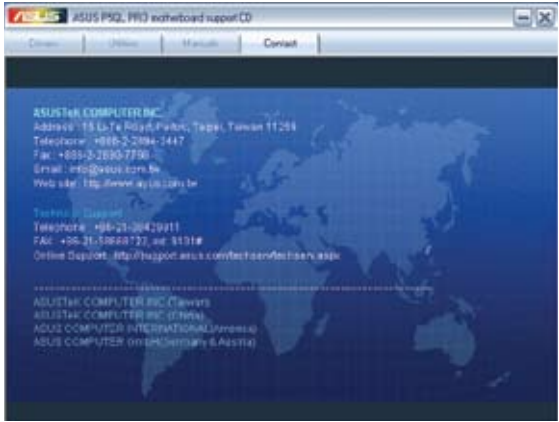

5.2.6 Other information

The icons on the top right corner of the screen give additional information on the motherboard and the contents of the support DVD. Click an icon to display the specified information.

Motherboard Info

Displays the general specifications of the motherboard.

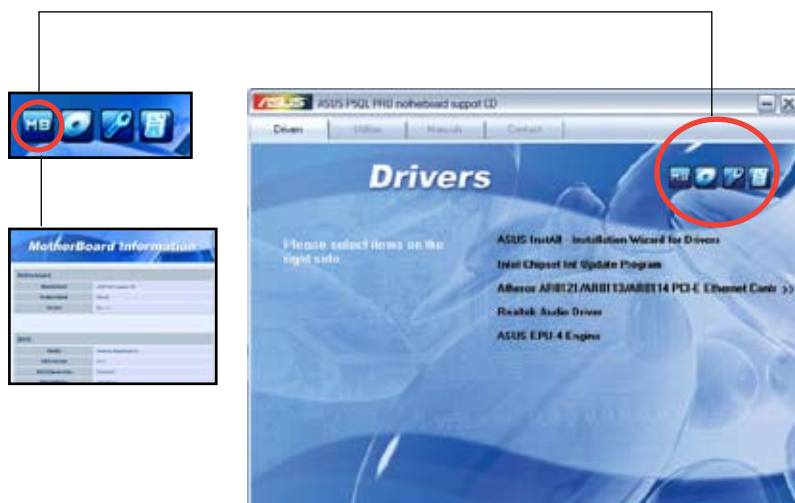

Browse this DVD

Displays the support DVD contents in graphical format.

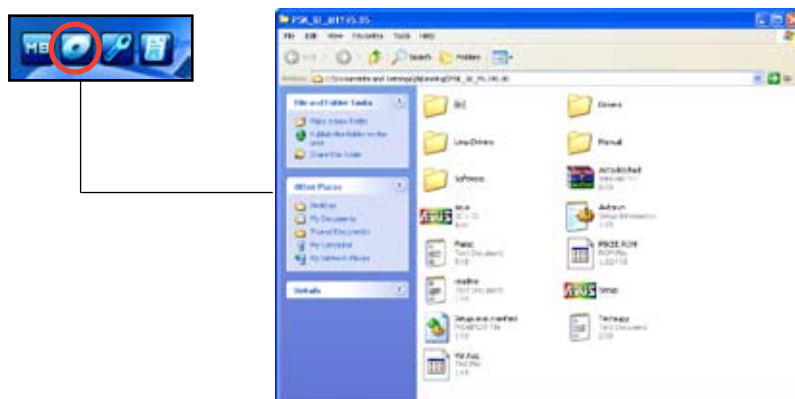

Technical support Form

Displays the ASUS Technical Support Request Form that you have to fill out when requesting technical support.



Filelist

Displays the contents of the support DVD and a brief description of each in text format.

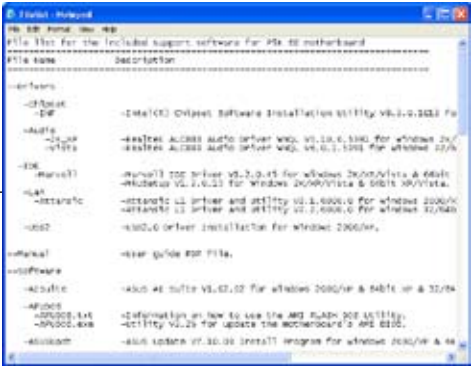

5.3 Software information

Most of the applications in the Support DVD have wizards that will conveniently guide you through the installation. View the online help or readme file that came with the software application for more information.

5.3.1 ASUS MyLogo2™

The ASUS MyLogo2™ utility lets you customize the boot logo. The boot logo is the image that appears on screen during the Power-On Self-Tests (POST). The ASUS MyLogo2™ is automatically installed when you install the ASUS Update utility from the Support DVD. See section “5.2.3 Utilities menu” for details.



- Before using the ASUS MyLogo2™, use the AFUDOS utility to make a copy of your original BIOS file, or obtain the latest BIOS version from the ASUS website. See section “4.1.4 AFUDOS utility”.
- Ensure that the BIOS item **Full Screen Logo** is set to **[Enabled]** if you want to use ASUS MyLogo2. See section 4.7.2 **Boot Settings Configuration**.
- You can create your own boot logo image in GIF, or BMP file formats.
- The file size should be smaller than 150 K.

To launch the ASUS MyLogo2™:

1. Launch the ASUS Update utility. Refer to section “4.1.1 ASUS Update utility” for details.
2. Select **Options** from the drop down menu, then click **Next**.
3. Check the option **Launch MyLogo** to replace system boot logo before flashing BIOS, then click **Next**.
4. Select **Update BIOS** from a file from the drop down menu, then click **Next**.
5. When prompted, locate the new BIOS file, then click **Next**. The ASUS MyLogo window appears.
6. From the left window pane, select the folder that contains the image you intend to use as your boot logo.

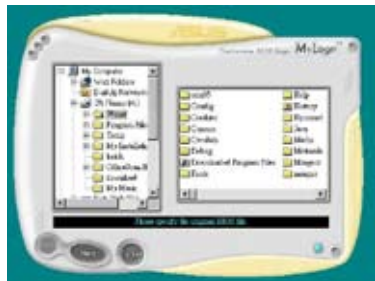

7. When the logo images appear on the right window pane, select an image to enlarge by clicking on it.

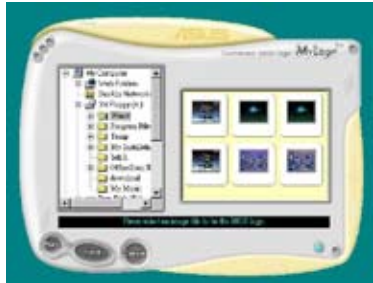

8. Adjust the boot image to your desired size by selecting a value on the Ratio box.



9. When the screen returns to the ASUS Update utility, flash the original BIOS to load the new boot logo.
10. After flashing the BIOS, restart the computer to display the new boot logo during POST.

5.3.2 Audio configurations

The Realtek® ALC1200 audio CODEC provides 8-channel audio capability to deliver the ultimate audio experience on your computer. The software provides Jack-Sensing function, S/PDIF Out support, and interrupt capability. The ALC1200 also includes the Realtek® proprietary UAJ® (Universal Audio Jack) technology for all audio ports, eliminating cable connection errors and giving users plug and play convenience.

Follow the installation wizard to install the Realtek® Audio Driver from the Support DVD that came with the motherboard package.

If the Realtek audio software is correctly installed, you will find the Realtek HD Audio Manager icon on the taskbar.

From the taskbar, double-click on the SoundEffect icon to display the Realtek HD Audio Manager.



Realtek HD Audio Manager

Realtek HD Audio Manager



Information

Click the information button () to display information about the audio driver version, DirectX version, audio controller, audio codec, and language setting.



Minimize

Click the minimize button () to minimize the window.

Exit

Click the exit button () to exit the Realtek HD Audio Manager.

Configuration options

Click any of the tabs in this area to configure your audio settings.

Sound Effect

The Realtek® ALC1200 Audio CODEC allows you to set your listening environment, adjust the equalizer, set the karaoke, or select pre-programmed equalizer settings for your listening pleasure.

To set the sound effect options:

1. From the Realtek HD Audio Manager, click the Sound Effect tab.
2. Click the shortcut buttons or the drop-down menus for options on changing the acoustic environment, adjust the equalizer, or set the karaoke to your desired settings.
3. Click  to effect the Sound Effect settings and exit.



Mixer

The Mixer option allows you to configure audio output (playback) volume and audio input (record) volume.

To set the mixer options:

1. From the Realtek HD Audio Manager, click the Mixer tab.
2. Turn the volume buttons to adjust the Playback and/or Record volume.



The Mixer option activates voice input from all channels by default. Make sure to set all channels to mute (M) if you do not want voice input.

3. Make adjustments to Wave, SW Synth, Front, Rear, CD volume, Mic volume, Line Volume, and Stereo mix, etc. by clicking the control tabs and dragging them up and down until you get the desired levels.



Click the next button (Next) to display more menu options.

4. Click **OK** to effect the Mixer settings and exit.



Audio I/O

The Audio I/O option allows you configure your input/output settings.

To set the Audio I/O options:

1. From the Realtek HD Audio Manager, click the Audio I/O tab.
2. Click the drop-down menu to select the channel configuration.
3. The control settings window displays the status of connected devices.
Click  for analog and digital options.
4. Click <OK> to effect the Audio I/O settings and exit



Microphone

The Microphone option allows you configure your input/output settings and to check if your audio devices are connected properly.

To set the Microphone options:



1. From the Realtek HD Audio Manager, click the Microphone tab.
2. Click the Noise Suppression option button to reduce the static background noise when recording.
3. Click the Acoustic Echo Cancellation option button to reduce the echo from the front speakers when recording.
4. Click  to effect the Microphone settings and exit.



3D Audio Demo

The 3D Audio Demo option gives you a demonstration of the 3D audio feature.

To start the 3D Audio Demo:

1. From the Realtek HD Audio Manager, click the 3D Audio Demo tab.
2. Click the option buttons to change the sound, moving path, or environment settings.
3. Click  to test your settings.
4. Click  to effect the 3D Audio Demo settings and exit.



5.3.3 ASUS PC Probe II

PC Probe II is a utility that monitors the computer's vital components, and detects and alerts you of any problem with these components. PC Probe II senses fan rotations, CPU temperature, and system voltages, among others. Because PC Probe II is software-based, you can start monitoring your computer the moment you turn it on. With this utility, you are assured that your computer is always at a healthy operating condition.

Installing PC Probe II

To install PC Probe II on your computer:

1. Place the Support DVD to the optical drive. The Drivers installation tab appears if your computer has an enabled Autorun feature.



If Autorun is not enabled in your computer, browse the contents of the Support DVD to locate the setup.exe file from the ASUS PC Probe II folder. Double-click the **setup.exe** file to start installation.

2. Click the **Utilities** tab, then click **ASUS PC Probe II**.
3. Follow the screen instructions to complete installation.

Launching PC Probe II

You can launch the PC Probe II right after installation or anytime from the Windows® desktop.

To launch the PC Probe II from the Windows® desktop, click **Start > All Programs > ASUS > PC Probe II > PC Probe II v1.xx.xx**. The PC Probe II main window appears.

After launching the application, the PC Probe II icon appears in the Windows® taskbar. Click this icon to close or restore the application.









Using PC Probe II

Main window

The PC Probe II main window allows you to view the current status of your system and change the utility configuration. By default, the main window displays the Preference section. You can close or restore the Preference section by clicking on the triangle on the main window right handle.



Click to close the Preference panel

Button	Function
	Opens the Configuration window
	Opens the Report window
	Opens the Desktop Management Interface window
	Opens the Peripheral Component Interconnect window
	Opens the Windows Management Instrumentation window
	Opens the hard disk drive, memory, CPU usage window
	Shows/Hides the Preference section
	Minimizes the application
	Closes the application

Sensor alert

When a system sensor detects a problem, the main window right handle turns red, as the illustrations below show.



When displayed, the monitor panel for that sensor also turns red. Refer to the Monitor panels section for details.

Hardware monitor panels

The hardware monitor panels display the current value of a system sensor such as fan rotation, CPU temperature, and voltages.

The hardware monitor panels come in two display modes: hexagonal (large) and rectangular (small). When you check the Enable Monitoring Panel option from the Preference section, the monitor panels appear on your computer's desktop.



Large display



Small display

Changing the monitor panels position

To change the position of the monitor panels in the desktop, click the arrow down button of the Scheme options, then select another position from the list box. Click OK when finished.



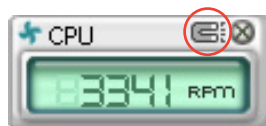

Moving the monitor panels

All monitor panels move together using a magnetic effect. If you want to detach a monitor panel from the group, click the horseshoe magnet icon. You can now move or reposition the panel independently.



Adjusting the sensor threshold value

You can adjust the sensor threshold value in the monitor panel by clicking the  or  buttons. You can also adjust the threshold values using the Config window.

You cannot adjust the sensor threshold values in a small monitoring panel.

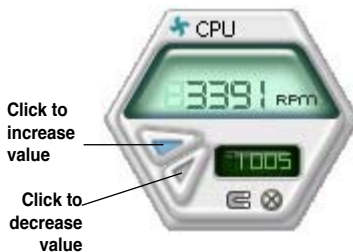

Monitoring sensor alert

The monitor panel turns red when a component value exceeds or is lower than the threshold value. Refer to the illustrations below.



Large display



Small display

WMI browser

Click **WMI** to display the WMI (Windows Management Instrumentation) browser. This browser displays various Windows® management information. Click an item from the left panel to display on the right panel. Click the plus sign (+) before WMI Information to display the available information.



You can enlarge or reduce the browser size by dragging the bottom right corner of the browser.

DMI browser

Click **DMI** to display the DMI (Desktop Management Interface) browser. This browser displays various desktop and system information. Click the plus sign (+) before DMI Information to display the available information.



PCI browser

Click **PCI** to display the PCI (Peripheral Component Interconnect) browser. This browser provides information on the PCI devices installed on your system. Click the plus sign (+) before the PCI Information item to display available information.



Usage

The Usage browser displays real-time information on the CPU, hard disk drive space, and memory usage. Click **USAGE** to display the Usage browser.

CPU usage

The CPU tab displays real-time CPU usage in line graph representation. If the CPU has an enabled Hyper-Threading, two separate line graphs display the operation of the two logical processors.

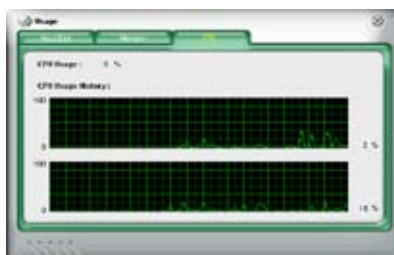

Hard disk drive space usage

The Hard Disk tab displays the used and available hard disk drive space. The left panel of the tab lists all logical drives. Click a hard disk drive to display the information on the right panel. The pie chart at the bottom of the window represents the used (blue) and the available HDD space.



Memory usage

The Memory tab shows both used and available physical memory. The pie chart at the bottom of the window represents the used (blue) and the available



Configuring PC Probe II

Click  to view and adjust the sensor threshold values.

The Config window has two tabs: Sensor/Threshold and Preference. The Sensor/Threshold tab enables you to activate the sensors or to adjust the sensor threshold values. The Preference tab allows you to customize sensor alerts, or change the temperature scale.

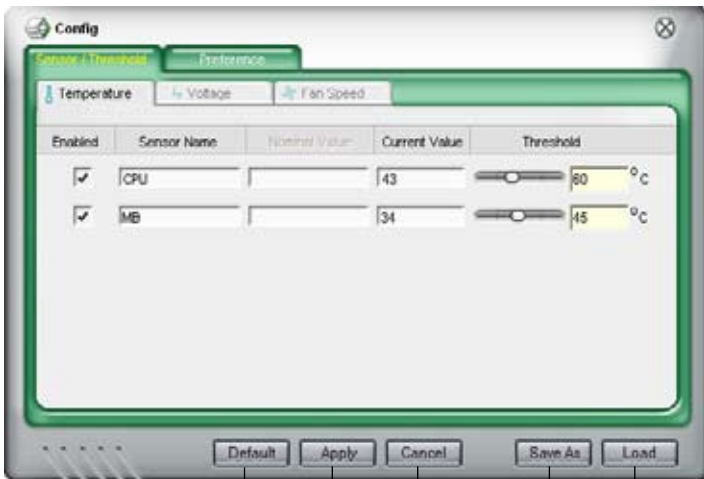

Loads the default threshold values for each sensor

Applies your changes

Cancels or ignores your changes

Loads your saved configuration
Saves your configuration

5.3.4 ASUS AI Suite

ASUS AI Suite allows you to launch AI Booster, AI Nap, and Fan Xpert utilities easily.

Installing AI Suite

To install AI Suite on your computer:

1. Place the support DVD to the optical drive. The Drivers installation tab appears if your computer has an enabled Autorun feature.
2. Click the Utilities tab, then click **AI Suite**.
3. Follow the screen instructions to complete installation.

Launching AI Suite

You can launch AI Suite right after installation or anytime from the Windows® desktop.

To launch AI Suite from the Windows® desktop, click **Start > All Programs > ASUS > AI Suite > AI Suite v1.xx.xx**. The AI Suite main window appears.

After launching the application, the AI Suite icon appears in the Windows® taskbar. Click this icon to close or restore the application.

Using AI Suite

Click the AI Nap, AI Booster, or Fan Xpert icon to launch the utility, or click the Normal icon to restore the system to normal state.

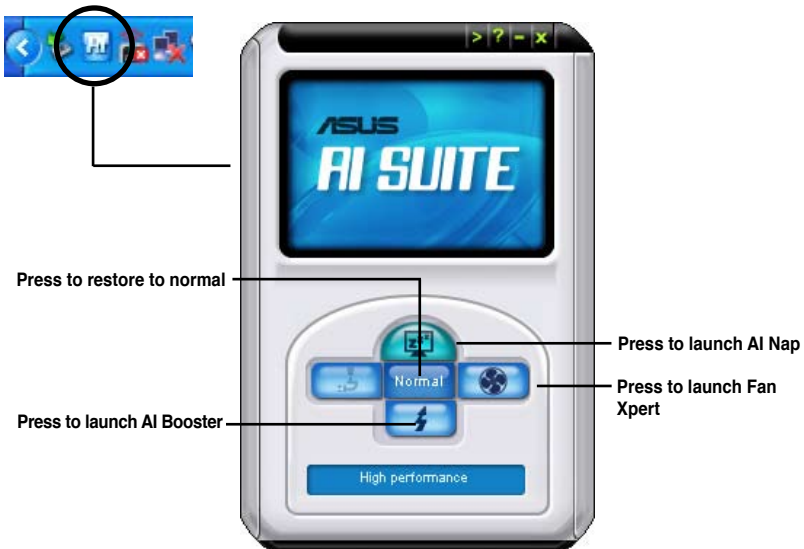

Other feature buttons

Click  on right corner of the main window to open the monitor window.

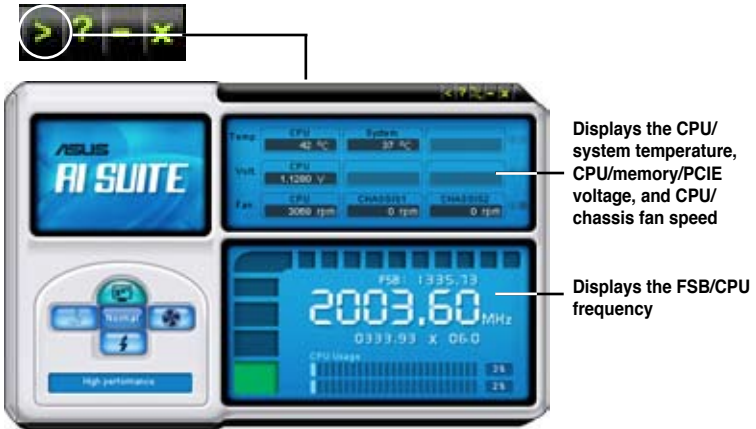

Click  on right corner of the expanded window to switch the temperature from degrees Centigrade to degrees Fahrenheit.



5.3.5 ASUS AI Booster

The ASUS AI Booster application allows you to overclock the CPU speed in Windows® environment without the hassle of booting the BIOS.

After installing AI Suite from the bundled support DVD, you can launch the utility by double-clicking the AI Suite icon on the Windows® OS taskbar and click the AI Booster button on the AI Suite main window.

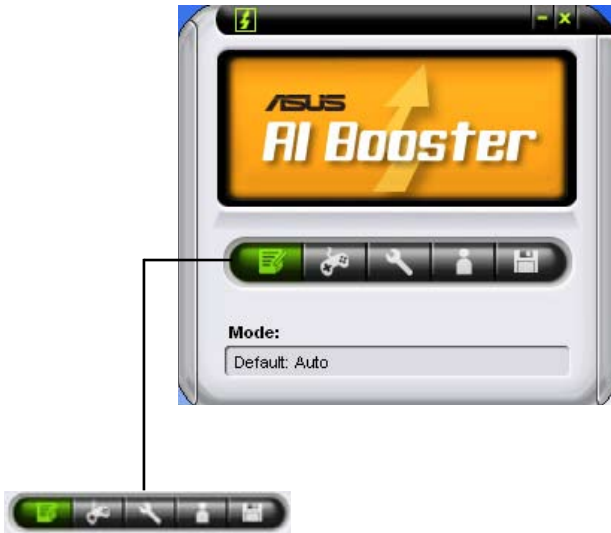

The options on the taskbar allow you to use the default settings, adjust CPU/ Memory/PCI-E frequency manually, or create and apply your personal overclocking configurations.

5.3.6 ASUS AI Nap

This feature allows you to minimize the power consumption of your computer whenever you are away. Enable this feature for minimum power consumption and a more quiet system operation.

After installing AI Suite from the bundled support DVD, you can launch the utility by double-clicking the AI Suite icon on the Windows OS taskbar and click the AI Nap button on the AI Suite main window.

Click **Yes** on the confirmation screen.

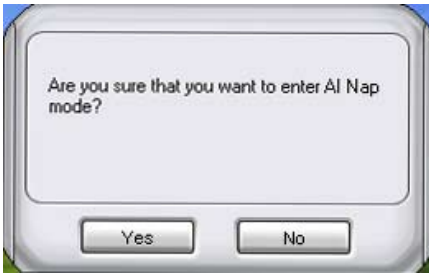

To exit AI Nap mode, press the system power or mouse button then click **Yes** on the confirmation screen.

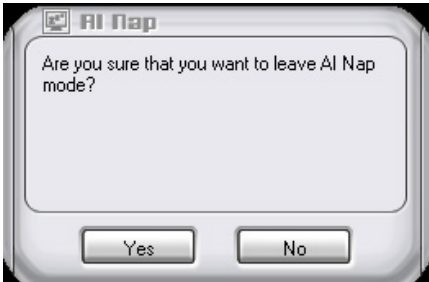

To switch the power button functions from AI Nap to shutting down, just right click the **AI Suite** icon on the OS taskbar, select **AI Nap** and click **Use power button**. Uncheck the item to switch the function back.

5.3.7 ASUS Fan Xpert

ASUS Fan Xpert intelligently allows you to adjust the CPU fan speed according to different ambient temperatures caused by different climate conditions in different geographic regions and your PC's system loading. The built-in variety of useful profiles offer flexible controls of fan speed to achieve a quiet and cool environment.

Install AI Suite from the bundled support DVD. To launch the ASUS Fan Xpert utility, double-click the **AI Suite** icon on the Windows® notification bar and click the **Fan Xpert** button on the AI Suite main window.



5.3.8 ASUS EPU-4 Engine

ASUS EPU-4 Engine is an energy-efficient tool that satisfies different computing needs. This utility provides three modes that you can select to enhance system performance or save power. Selecting Auto mode will have the system shift modes automatically according to current system status. You can also customize each mode by configuring settings like CPU Loadline, vCore Voltage Downgrade, and Fan Control.

Installing 4 Engine

To install 4 Engine on your computer:

1. Place the support DVD to the optical drive. The **Drivers** menu appears if Autorun is enabled on your computer.
2. Click **ASUS EPU-4 Engine**.
3. Follow the screen instructions to complete installation.

Launching 4 Engine

Launch 4 Engine by double-clicking the 4 Engine icon on the Windows® notification area.



The first time you launch 4 Engine, the following message will appear, asking you to run Calibration first. Running calibration allows the system to detect CPU properties to optimize power management.



Click **Run Calibration** and wait for a few seconds. Then, the 4 Engine main menu appears.

4 Engine main menu

The screenshot shows the ASUS 4 Engine main menu. At the top, there are two smaller windows: the first displays CPU Power and Total CPU Energy Saving; the second displays a message about VGA power saving engine detection. The main window has a header 'EPU-4 Engine the complete system power saving solution' and four icons for CPU, VGA, HDD, and Fan. Below these is a 'Reduced CO2 Emission' bar with a 'Current' button. The bottom section is divided into 'Mode Setting' (Auto, High Performance, Max. Power Saving) and 'Current Status' (Tranquility, Performance, Reliability, Convenience, Energy Saving). Callouts provide detailed descriptions for each element.

Displays CPU Power and Total CPU Energy Saving

Displays the following message if no VGA power saving engine is detected.

Lights up when power saving engine is activated

Displays the amount of CO2 reduced

*Shifts between the display of Total and Current CO2 reduced

Displays current mode

Auto Mode

High Performance Mode

Runs calibration



Max. Power Saving Mode

Displays the system properties of each mode

Exits the utility

Settings for each mode (refer to the next page for further information)

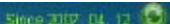

- * Click **Current**  to show the CO2 that has been reduced since you click the **Renew** button .
- * Click **Total**  to show the total CO2 that has been reduced since you launched 4 Engine.

Setting menu

Click Setting () from the 4 Engine main menu to display configuration options in each mode. Some options in certain modes are dimmed, meaning that they are not available.

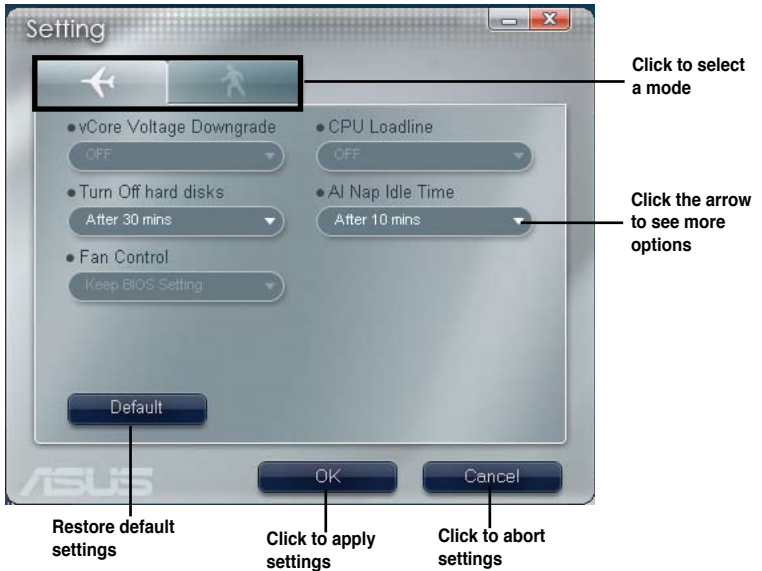

Configuration options in Setting menu

The following lists the configuration options and their definitions in Setting menu.

- **vCore Voltage Downgrade:** Lowers CPU vCore voltage.
 - **High:** Downgrades voltage to the highest level for CPU power saving.
 - **Medium:** Downgrades voltage to the medium level.
 - **Small:** Downgrades voltage to the minimum level.
- **Turn Off hard disks:** Turns off hard disk drives when they are not accessed after a certain time.
- **CPU Loadline:** Sets up the CPU loadline to manage CPU power saving.
 - **Light:** Saves CPU power to the minimum level.
 - **Medium:** Saves CPU power to the medium level.
 - **Heavy:** Saves CPU power to the highest level.

- **Fan Control:** Adjusts fan speeds to reduce noise and save system power.
 - **Quiet:** Lowers CPU fan speed and shuts off two chassis fans.
 - **Slow:** Lowers CPU fan and two chassis fan speeds.
- **AI Nap Idle Time:** Enters AI Nap mode after a certain time during system idle process.

Refer to the following table for the configuration options in each mode.

Configuration options	Turbo Mode	High Performance Mode	Medium Power Saving Mode	Maximum Power Saving Mode
vCore Voltage Downgrade	N/A	N/A	Small/Medium/High	Small/Medium/High
Turn Off hard disks	Never/After 3 mins–After 5 hours	Never/After 3 mins–After 5 hours	Never/After 3 mins–After 5 hours	Never/After 3 mins–After 5 hours
CPU Loadline	N/A	N/A	Light/Medium/Heavy	Light/Medium/Heavy
Fan Control	N/A	N/A	Keep Bios Setting/Slow	Keep Bios Setting/Quiet
AI Nap Idle Time	Never/After 3 mins–After 5 hours	Never/After 3 mins–After 5 hours	Never/After 3 mins–After 5 hours	Never/After 3 mins–After 5 hours

5.3.9 ASUS Express Gate

ASUS Express Gate is an instant-on environment that gives you quick access to the Internet. Within a few seconds of powering on your computer, you will be at the Express Gate menu where you can start the web browser, Skype, or other Express Gate softwares.

Installing ASUS Express Gate



- ASUS Express Gate supports installation on SATA HDDs in **IDE mode** only.
- ASUS Express Gate supports HDDs connected to **motherboard chipset-controlled onboard SATA ports** only. All onboard extended SATA ports and external SATA ports are NOT supported. See chapter 2 for the exact location of onboard SATA ports.
- ASUS Express Gate supports installation on USB HDDs and Flash drives, but the software performance may be slower than installed on SATA HDDs.

To install Express Gate on your computer

1. Place the Support DVD/DVD to the optical drive. The **Drivers** installation tab appears if your computer has enabled Autorun feature.
2. Click the **Utilities** tab, then click **ASUS Express Gate Installer**.

3. Select the language for installation and click **OK**.

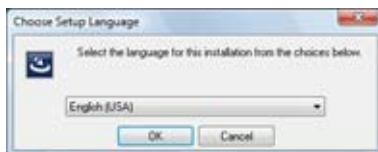

4. The InstallShield Wizard for Express Gate appears. Click **Next** to continue.

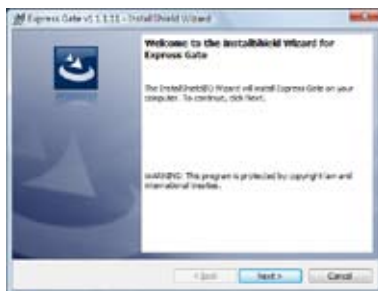

5. Select the target disk volume for you to install Express Gate. If you have multiple volumes and OS installed in your hard drive, it is recommended to install Express Gate in **Volume C**. Click **Next** to continue.
6. Follow the screen instructions to complete installation.



The First Screen

Express Gate's first screen appears within a few seconds after you power on the computer. From here, you can immediately start the web browser or Skype.

You can also choose to continue booting normally (e.g. to your installed OS such as Windows), enter BIOS setup, or power off.



If you don't make any selection, Express Gate will automatically exit and boot to your normal OS after a certain amount of time. The timer countdown is shown on-screen inside the "boot to OS" button. As you move the mouse or type a key, the countdown stops and the timer disappears, so you can take your time to make a selection.

The Express Gate Environment

The very first time you enter the Express Gate environment (by launching either web or Skype from the first screen), a first time wizard will guide you through basic Express Gate configurations. Basic configurations include language, date and time and screen resolution.



Once inside the Express Gate environment, click on the icons on the LaunchBar, by default at bottom of the screen, to launch or switch between softwares. You can re-arrange, re-size and move windows. Bring a window to the foreground by clicking within it or by clicking on its corresponding software icon. Re-size a window by dragging any of its four corners. Move a window by dragging its title bar.

Besides using the LaunchBar, you can also switch between softwares by pressing <Alt> +<Tab> on the keyboard. You can also right-click anywhere on the desktop to bring up a menu of softwares.

The red triangle on an software icon in the LaunchBar denotes that the software is already running. This means that you can switch to it without any delay. In the rare case where an software stops responding, right-click on its icon to force close it.

Knowing the Express Gate hot-keys

Here is a list of common-used hot-keys for Express Gate.

In the First Screen:

Key	Function
PAUSE/BREAK	Power-off
ESC	Continue to boot OS
DEL	Enter BIOS setup
F8	Enter Boot selection pop-up

In the Express Gate Environment:

Key	Function
<Alt> + <Tab>	Switch between softwares
<Ctrl> + <Alt> + 	Bring up Power-Off dialog box
<Ctrl> + <Alt> + <Print Screen>	Save screen snapshot as picture to file

Using the Configuration Panel

Use the configuration panel to change various Express Gate settings.



Click on an icon to open a particular configuration tool. The following tools are available:

- **Date and Time:** set current date and time as well as time zone.
- **Input Method:** choose your preferred input language and method.
- **Language and Keyboard:** choose your language and keyboard preferences.
- **LaunchBar Settings:** customize your LaunchBar (where it docks, whether it auto-hides, etc.)
- **Network:** Specify how your computer connects to the Internet. Enable all the network ports that you may use (LAN1, LAN2, and/or wireless [optional]). LAN1 and LAN2 refer to the two RJ-45 network ports on your computer.



- The number of the LAN ports may differ from motherboards.
- You can connect the LAN cable to either port, and Express Gate will automatically use the connected port.

Also specify whether each port uses DHCP (most common) or static IP. For PPPoE and wireless (optional), set the login credentials (user name, password, SSID, etc.) as well.

- **Environment Settings:** This function allows you to clear the Express Gate settings, as well as any personal information stored by the web browser (Bookmarks, Cookies, History, etc.). The user data will be reset to the original default configuration.

After you click **Restore System**, a confirmation dialog box will open. If you click "Yes" in the confirmation dialog box, your system will immediately restart and then re-enter Express Gate to finish clearing the settings. This is also useful in the rare case where settings might become corrupted.



The first-time Wizard will run again when you enter the Express Gate environment after clearing its settings.

- **Screen Settings:** Choose the most optimal screen resolution for your display.
- **Volume Control:** Control the volume for your speaker output, microphone input, etc.

Using the LaunchBar

The LaunchBar has several system icons that show you various system statuses and let you configure individual Express Gate settings. The LaunchBar can be configured to auto-hide, if you want more screen space for the softwares. It can also be configured to dock on any of the four sides of the screen.



Starts the **Web Browser** for quick access to the World Wide Web.



Starts the **Photo Manager** album / organizer tool.



Starts the **Chat** instant messaging tool.



Start the **Skype** software, which lets you call other people on Skype for free, as well as offering affordable, high quality voice communications to phones all over the world.



Opens **Configuration Panel**, which lets you specify network settings and other preferences.

In the rare case that one of the above softwares stops responding, you can right-click on its icon and then select **Close** to force it to close.

The smaller icons on the right side of the LaunchBar are:



Click on this icon to open the **File Manager** window, which lets you conveniently access the files on a USB drive. If a USB device is detected, the icon contains a green arrow.



ASUS Express Gate supports file uploading from SATA HDDs, ODDs and USB drive and downloading to USB drives only.



Shows network status; click to configure network.



Shows mute status; click to change volume.



Click to choose input language and method as well as keyboard shortcuts (Ctrl-Space by default).



Click to change LaunchBar options (auto-hide, docking position, etc).



Click to show the “ASUS Utility” panel.



Click to show “About Express Gate ”.



Click to open Express Gate Help.



Click to bring up power options window to boot to OS, restart or power down. This window is also shown when you press **Ctrl-Alt-Del** on the keyboard.

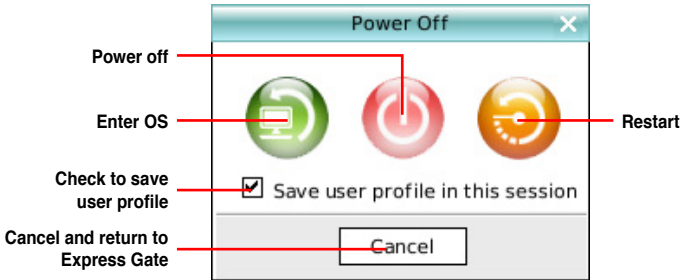

How Do I Get on to the Internet

If Internet doesn't seem to be working in the Express Gate environment, check the following:

1. **Open the Configuration Panel.**



Open Configuration Panel

2. Open Network.



3. Make the proper network configurations.

Each network interface is enabled immediately when you check the box next to it.

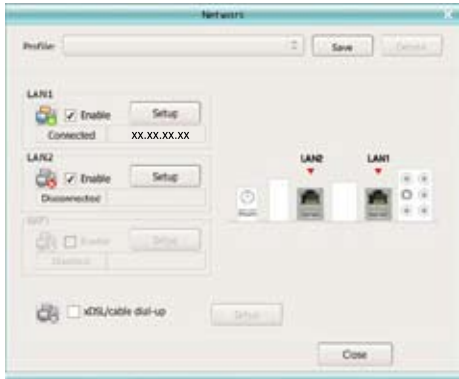

- If you use a network cable connected to a home router (which is then connected to your DSL/cable modem), enable both LAN1 and LAN2. Express Gate will automatically use whichever port (LAN1 or LAN2) is connected.



If you plug the network cable into a different port while Express Gate is running (e.g. move the cable from LAN1 to LAN2), you may need to press the "Refresh" button to detect the change.

- The most common scenario is for your computer to automatically obtain network settings (i.e. DHCP). If this is the case, you don't need to click **Setup** for any LAN port. If this is not the case, click **Setup** to configure the static IP settings manually.

- If you have wireless network, click **Setup** for the WiFi option. In the **WiFi** tab of the **Advanced Network Settings** box, enter the name of your wireless access point in the **SSID** field. If your wireless access point has security enabled, select the corresponding security algorithm from the drop-down list (e.g. WEPAUTO) in the **Encryption Type** field, and enter the password.
Click **OK** to enable WiFi and establish the wireless connection.
- If you use a network cable connected directly to your DSL/cable modem (no router in between), click **Setup** for xDSL/cable dial-up. This method is also referred to as PPPoE. Choose whether the DSL/cable modem is connected to your computer's LAN port. Then enter the username and password for your dial-up account.
Click **OK** to enable xDSL/cable dial-up and establish the PPPoE connection. When PPPoE is enabled, the port it uses will automatically be unchecked and grayed out.

Using the Photo Manager

Express Gate provides a easy-to-use **Photo Manager** that allows you to view pictures stored in your hard drive or external storage devices (such as USB dongles, card readers, or optical disks). You can view pictures in thumbnail view; in an enlarged view individually; in a filename/data list view; or play them in a slideshow with background music and fancy transition effects. JPEG, GIF, BMP, and PNG formats are supported. Refer to the on-line Help for detailed software operation.

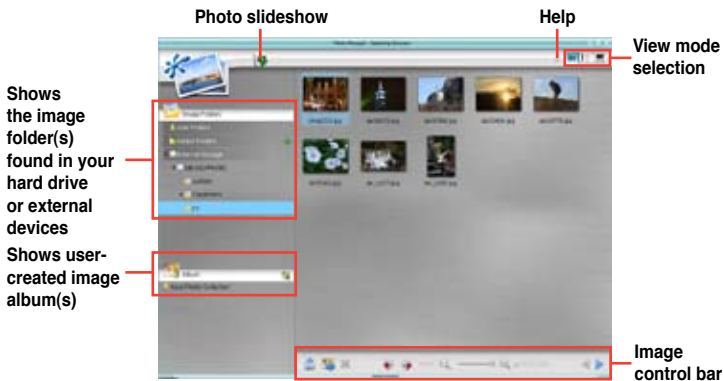

ASUS Express Gate supports HDDs connected to **motherboard chipset-controlled onboard SATA ports** only. All onboard extended SATA ports and external SATA ports are NOT supported.

Configuring Express Gate in BIOS Setup

Enter BIOS setup by pressing DEL key after powering on or by clicking on the BIOS setup icon on Express Gate's first screen. Express Gate configuration options are under the **Tools** menu. Refer to section 3.8.2 **Express Gate** for details.

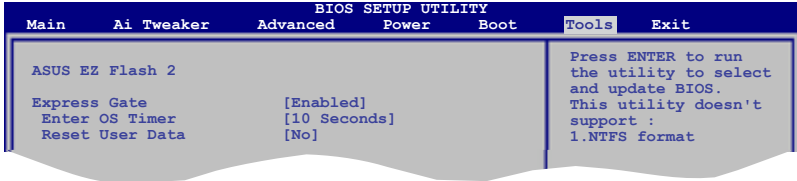

Updating Express Gate

You may update your existing Express Gate software to new versions. New versions of the Express Gate software will be released regularly, adding refinements or new applications. You can find original version of the software on the support DVD or download new versions from the ASUS support website.

To update Express Gate

1. Double-click the Express Gate setup file to start software update.
2. A software update confirmation dialog box appears. Click **Yes** to continue.
3. The InstallShield Wizard for Express Gate appears. Click **Next** to continue.
4. Follow the screen instructions to complete installation.

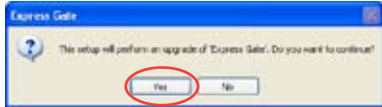

Repairing Express Gate

In case Express Gate cannot start normally, you can repair Express Gate by reinstalling the software or using the repairing utility.

To repair Express Gate

- Click **Start > All Programs > Express Gate > Express Gate Installer > Repair this software**.
- OR
- Double click the Express Gate setup file, choose **Repair**, and click **Next** to continue.



The Appendix describes the CPU features and technologies that the motherboard supports.

CPU features



Chapter summary



A.1	Intel® EM64T.....	A-1
A.2	Enhanced Intel SpeedStep® Technology (EIST).....	A-1
A.3	Intel® Hyper-Threading Technology	A-3

A.1 Intel® EM64T



- The motherboard is fully compatible with Intel® LGA775 processors running on 32-bit operating systems.
- The motherboard comes with a BIOS file that supports EM64T. You can download the latest BIOS file from the ASUS website (www.asus.com/support/download/) if you need to update the BIOS file. See Chapter 4 for details.
- Visit www.intel.com for more information on the EM64T feature.
- Visit www.microsoft.com for more information on Windows® 64-bit OS.

Using the Intel® EM64T feature

To use the Intel® EM64T feature:

1. Install an Intel® CPU that supports the Intel® EM64T.
2. Install a 64-bit operating system (Windows® Vista 64-bit Edition or Windows® XP Professional x64 Edition).
3. Install the 64-bit drivers for the motherboard components and devices from the support CD.
4. Install the 64-bit drivers for expansion cards or add-on devices, if any.



Refer to the expansion card or add-on device(s) documentation, or visit the related website, to verify if the card/device supports a 64-bit system.

A.2 Enhanced Intel SpeedStep® Technology (EIST)



- The motherboard comes with a BIOS file that supports EIST. You can download the latest BIOS file from the ASUS website (www.asus.com/support/download/) if you need to update the BIOS. See Chapter 4 for details.
- Visit www.intel.com for more information on the EIST feature.

A.2.1 System requirements

Before using EIST, check your system if it meets the following requirements:

- Intel® processor with EIST support
- BIOS file with EIST support
- Operating system with EIST support (Windows® Vista, Windows® XP SP2/ Linux 2.6 kernel or later versions)

A.2.2 Using the EIST

To use the EIST feature:

1. Turn on the computer, then enter the BIOS Setup.
2. Go to the Advanced Menu, highlight CPU Configuration, then press <Enter>.
3. Set the Intel(R) SpeedStep Technology item to [Automatic], then press <Enter>. See page 4-22 for details.
4. Press <F10> to save your changes and exit the BIOS setup.
5. After the computer restarts, right click on a blank space on the desktop, then select Properties from the pop-up menu.
6. When the Display Properties window appears, click the Screen Saver tab.
7. Click the Power button on the Monitor power section to open the Power Options Properties window.

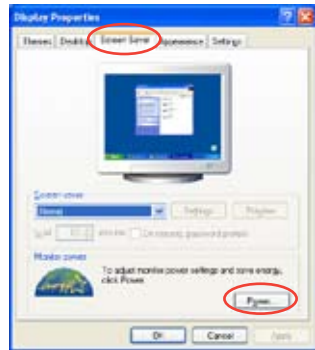

8. On the Power schemes section, click , then select any option except Home/Office Desktop or Always On.
9. Click Apply, then click OK.
10. Close the Display Properties window.

After you adjust the power scheme, the CPU internal frequency slightly decreases when the CPU loading is low.

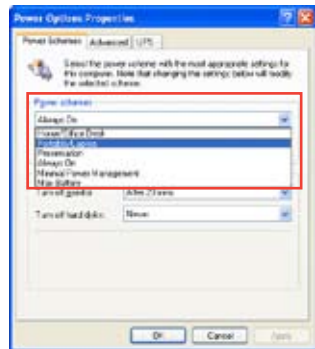

The screen displays and procedures may vary depending on the operating system.

A.3 Intel® Hyper-Threading Technology



- The motherboard supports Intel® Pentium® 4 LGA775 processors with Hyper-Threading Technology.
 - Hyper-Threading Technology is supported under Windows® Vista/XP/Linux 2.4.x (kernel) and later versions only. Under Linux, use the Hyper-Threading compiler to compile the code. If you are using any other operating systems, disable the Hyper-Threading Technology item in the BIOS to ensure system stability and performance.
 - Installing Windows® XP Service Pack 1 or later version is recommended.
 - Make sure to enable the Hyper-Threading Technology item in BIOS before installing a supported operating system.
 - For more information on Hyper-Threading Technology, visit www.intel.com/info/hyperthreading.
-

Using the Hyper-Threading Technology

To use the Hyper-Threading Technology:

1. Install an Intel® Pentium® 4 CPU that supports Hyper-Threading Technology.
2. Power up the system and enter the BIOS Setup. Under the Advanced Menu, make sure that the item **Hyper-Threading Technology** is set to [Enabled].
The BIOS item appears only if you installed a CPU that supports Hyper-Threading Technology.
3. Restart the computer.

