

P5KPL-AM SE

ASUS[®]

Motherboard

E4323

Second Edition V2

November 2008

Copyright © 2008 ASUSTeK Computer Inc. All Rights Reserved.

No part of this manual, including the products and software described in it, may be reproduced, transmitted, transcribed, stored in a retrieval system, or translated into any language in any form or by any means, except documentation kept by the purchaser for backup purposes, without the express written permission of ASUSTeK Computer Inc. ("ASUS").

Product warranty or service will not be extended if: (1) the product is repaired, modified or altered, unless such repair, modification of alteration is authorized in writing by ASUS; or (2) the serial number of the product is defaced or missing.

ASUS PROVIDES THIS MANUAL "AS IS" WITHOUT WARRANTY OF ANY KIND, EITHER EXPRESS OR IMPLIED, INCLUDING BUT NOT LIMITED TO THE IMPLIED WARRANTIES OR CONDITIONS OF MERCHANTABILITY OR FITNESS FOR A PARTICULAR PURPOSE. IN NO EVENT SHALL ASUS, ITS DIRECTORS, OFFICERS, EMPLOYEES OR AGENTS BE LIABLE FOR ANY INDIRECT, SPECIAL, INCIDENTAL, OR CONSEQUENTIAL DAMAGES (INCLUDING DAMAGES FOR LOSS OF PROFITS, LOSS OF BUSINESS, LOSS OF USE OR DATA, INTERRUPTION OF BUSINESS AND THE LIKE), EVEN IF ASUS HAS BEEN ADVISED OF THE POSSIBILITY OF SUCH DAMAGES ARISING FROM ANY DEFECT OR ERROR IN THIS MANUAL OR PRODUCT.

SPECIFICATIONS AND INFORMATION CONTAINED IN THIS MANUAL ARE FURNISHED FOR INFORMATIONAL USE ONLY, AND ARE SUBJECT TO CHANGE AT ANY TIME WITHOUT NOTICE, AND SHOULD NOT BE CONSTRUED AS A COMMITMENT BY ASUS. ASUS ASSUMES NO RESPONSIBILITY OR LIABILITY FOR ANY ERRORS OR INACCURACIES THAT MAY APPEAR IN THIS MANUAL, INCLUDING THE PRODUCTS AND SOFTWARE DESCRIBED IN IT.

Products and corporate names appearing in this manual may or may not be registered trademarks or copyrights of their respective companies, and are used only for identification or explanation and to the owners' benefit, without intent to infringe.

Contents

Notices.....	v
Safety information	vi
About this guide	vi
P5KPL-AM SE specifications summary.....	viii

Chapter 1: Product information

1.1	Before you proceed	1-1
1.2	Motherboard overview.....	1-2
	1.2.1 Motherboard layout.....	1-2
	1.2.2 Layout contents.....	1-2
1.3	Central Processing Unit (CPU)	1-3
1.4	System memory	1-3
	1.4.1 Overview	1-3
	1.4.2 Memory configurations.....	1-3
1.5	Expansion slots.....	1-7
	1.5.1 PCI slot	1-7
	1.5.2 PCI Express x1 slot.....	1-7
	1.5.3 PCI Express x16 slot.....	1-7
1.6	Jumpers	1-7
1.7	Connectors	1-9
	1.7.1 Rear panel ports	1-9
	1.7.2 Internal connectors	1-10
1.8	Software support.....	1-15
	1.8.1 Installing an operating system	1-15
	1.8.2 Support DVD information	1-15

Chapter 2: BIOS information

2.1	Managing and updating your BIOS	2-1
	2.1.1 ASUS Update utility	2-1
	2.1.2 ASUS EZ Flash 2 utility.....	2-2
	2.1.3 ASUS CrashFree BIOS 3 utility	2-3
2.2	BIOS setup program	2-4
2.3	Main menu	2-4
	2.3.1 System Time	2-4
	2.3.2 System Date	2-4

Contents

- 2.3.3 Primary IDE/SATA..... 2-5
- 2.3.4 Storage Configuration 2-5
- 2.3.5 System Information 2-6
- 2.4 Advanced menu 2-6**
 - 2.4.1 JumperFree Configuration 2-6
 - 2.4.2 USB Configuration 2-8
 - 2.4.3 CPU Configuration 2-8
 - 2.4.4 Chipset 2-9
 - 2.4.5 Onboard Devices Configuration 2-10
 - 2.4.6 PCI PnP 2-10
- 2.5 Power menu 2-11**
 - 2.5.1 Suspend Mode 2-11
 - 2.5.2 ACPI 2.0 Support 2-11
 - 2.5.3 ACPI APIC Support 2-11
 - 2.5.4 APM Configuration 2-11
 - 2.5.5 Hardware Monitor 2-12
- 2.6 Boot menu 2-13**
 - 2.6.1 Boot Device Priority 2-13
 - 2.6.2 Boot Settings Configuration 2-13
 - 2.6.3 Security 2-14
- 2.7 Tools menu 2-15**
 - 2.7.1 ASUS EZ Flash 2 2-15
 - 2.7.2 AI NET 2 2-15
- 2.8 Exit menu 2-16**

Notices

Federal Communications Commission Statement

This device complies with Part 15 of the FCC Rules. Operation is subject to the following two conditions:

- This device may not cause harmful interference, and
- This device must accept any interference received including interference that may cause undesired operation.

This equipment has been tested and found to comply with the limits for a Class B digital device, pursuant to Part 15 of the FCC Rules. These limits are designed to provide reasonable protection against harmful interference in a residential installation. This equipment generates, uses and can radiate radio frequency energy and, if not installed and used in accordance with manufacturer's instructions, may cause harmful interference to radio communications. However, there is no guarantee that interference will not occur in a particular installation. If this equipment does cause harmful interference to radio or television reception, which can be determined by turning the equipment off and on, the user is encouraged to try to correct the interference by one or more of the following measures:

- Reorient or relocate the receiving antenna.
- Increase the separation between the equipment and receiver.
- Connect the equipment to an outlet on a circuit different from that to which the receiver is connected.
- Consult the dealer or an experienced radio/TV technician for help.



The use of shielded cables for connection of the monitor to the graphics card is required to assure compliance with FCC regulations. Changes or modifications to this unit not expressly approved by the party responsible for compliance could void the user's authority to operate this equipment.

Canadian Department of Communications Statement

This digital apparatus does not exceed the Class B limits for radio noise emissions from digital apparatus set out in the Radio Interference Regulations of the Canadian Department of Communications.

This class B digital apparatus complies with Canadian ICES-003.



DO NOT throw the motherboard in municipal waste. This product has been designed to enable proper reuse of parts and recycling. This symbol of the crossed out wheeled bin indicates that the product (electrical and electronic equipment) should not be placed in municipal waste. Check local regulations for disposal of electronic products.



DO NOT throw the mercury-containing button cell battery in municipal waste. This symbol of the crossed out wheeled bin indicates that the battery should not be placed in municipal waste.

Safety information

Electrical safety

- To prevent electric shock hazard, disconnect the power cable from the electric outlet before relocating the system.
- When adding or removing devices to or from the system, ensure that the power cables for the devices are unplugged before the signal cables are connected. If possible, disconnect all power cables from the existing system before you add a device.
- Before connecting or removing signal cables from the motherboard, ensure that all power cables are unplugged.
- Seek professional assistance before using an adapter or extension cord. These devices could interrupt the grounding circuit.
- Ensure that your power supply is set to the correct voltage in your area. If you are not sure about the voltage of the electrical outlet you are using, contact your local power company.
- If the power supply is broken, do not try to fix it by yourself. Contact a qualified service technician or your retailer.

Operation safety

- Before installing the motherboard and adding devices on it, carefully read all the manuals that came with the package.
- Before using the product, ensure that all cables are correctly connected and the power cables are not damaged. If you detect any damage, contact your dealer immediately.
- To avoid short circuits, keep paper clips, screws, and staples away from connectors, slots, sockets, and circuitry.
- Avoid dust, humidity, and temperature extremes. Do not place the product in any area where it may become wet.
- Place the product on a flat and stable surface.
- If you encounter technical problems with the product, contact a qualified service technician or your retailer.

About this guide

This user guide contains the information you need when installing and configuring the motherboard.

How this guide is organized

This guide contains the following parts:

- **Chapter 1: Product introduction**
This chapter describes the features of the motherboard and the new technology it supports.
- **Chapter 2: BIOS setup**
This chapter tells how to change system settings through the BIOS setup menus. Detailed descriptions of the BIOS parameters are also provided.

Conventions used in this guide

To ensure that you perform certain tasks properly, take note of the following symbols used throughout this manual.



DANGER/WARNING: Information to prevent injury to yourself when trying to complete a task.



CAUTION: Information to prevent damage to the components when trying to complete a task.



IMPORTANT: Instructions that you **MUST** follow to complete a task.



NOTE: Tips and additional information to help you complete a task.

Where to find more information

Refer to the following sources for additional information and for product and software updates.

1. ASUS websites

The ASUS website provides updated information on ASUS hardware and software products.

2. Optional documentation

Your product package may include optional documentation, such as warranty flyers, that may have been added by your dealer. These documents are not part of the standard package.

Typography

Bold text

Indicates a menu or an item to select.

Italics

Used to emphasize a word or a phrase.

<Key>

Keys enclosed in the less-than and greater-than sign means that you must press the enclosed key.

Example: <Enter> means that you must press the Enter or Return key.

<Key1>+<Key2>+<Key3>

If you must press two or more keys simultaneously, the key names are linked with a plus sign (+).

Example: <Ctrl>+<Alt>+<D>

Command

Means that you must type the command exactly as shown, then supply the required item or value enclosed in brackets. Example: At the DOS prompt, type the command line:

```
afudos /i [filename]
```

```
afudos /i P5KPLAMS.ROM
```

P5KPL-AM SE specifications summary

CPU	LGA775 socket for Intel® Core™2 Quad/ Core™2 Extreme / Core™2 Duo / Pentium® D / Pentium® 4 / Celeron® E 1000 Series and Celeron 400 Series Processors Compatible with Intel® 05B / 05A / 06 processors Intel® Hyper-Threading Technology ready (Refer to www.asus.com for Intel CPU support list)
Chipset	Northbridge: Intel® G31 Southbridge: Intel® ICH7
Front Side Bus	1600(O.C.) / 1333 / 1066 / 800 / 533MHz
Memory	Dual channel memory architecture 2 x 240-pin DIMM sockets supports unbuffered non-ECC 4GB 1066(O.C.)/800/667 MHz DDR2 memory modules
Expansion Slots	1 x PCI Express x16 slot 1 x PCI Express x1 slot 1 x PCI slot
VGA	Integrated Gfx (Intel GMA3100) in North bridge supports <ul style="list-style-type: none"> - Maximum resolution: 2048 x 1536 x 32 bpp, - Maximum shared memory of 256 MB - Horizontal: 127.5 KHz, Vertical: 85Hz
Storage	Southbridge Intel® ICH7 supports: <ul style="list-style-type: none"> - 1 x UltraDMA 100 / 66 / 33 hard disk drives - 2 x SATA 3 Gb/s ports
LAN	Realtek® RTL8102EL, 10/100
Audio	6-CH ALC662 high-Definition Audio CODEC Anti-Pop function Jack-detect & Multi-Streaming
USB	Max. 8 x USB2.0 ports (4 ports at mid-board, 4 ports at back panel)
ASUS Features	ASUS CrashFree BIOS 3 ASUS Q-Fan ASUS EZ Flash 2 ASUS MyLogo 2
Rear panel	1 x PS/2 keyboard port 1 x PS/2 mouse port 1 x VGA port 1 x COM 1 x LAN (RJ-45) port 4 x USB 2.0 ports 6-channel audio I/O port

(continued on the next page)

P5KPL-AM SE specifications summary

Internal connectors	<p>2 x USB 2.0 connectors supports additional 4 USB ports 1 x internal speaker connector 2 x Serial ATA connectors 1 x CPU fan connector 1 x Chassis fan connector 1 x CD audio in connector 1 x 24-pin EATXPWR 12 V power connector 1 x 4-pin ATX 12 V power connector 1 x Front panel High Definition audio connector 1 x System Panel connector</p>
ASUS Exclusive Overclocking Features	<p>SFS (Stepless Frequency Selection) - FSB turning from 133MHz up to 600MHz at 1MHz increment. Overclocking Protection: - ASUS C.P.R. (CPU Parameter Recall)</p>
BIOS features	<p>8 Mb Flash ROM, AMI BIOS, PnP, DMI2.0, WfM2.0, ACPI V2.0a, SM BIOS 2.5</p>
Manageability	<p>WOL, PXE,RPL, WOR BY Ring, PME Wake Up</p>
Support DVD contents	<p>Drivers ASUS PC Probe II ASUS Update utility Anti-virus software (OEM)</p>
Accessories	<p>1 x Serial ATA cable 1 x Ultra ATA66 cable I/O shield User manual</p>
Form factor	<p>uATX form factor: 9.6 in x 7.2 in (24.5 cm x 18.3cm)</p>

**Specifications are subject to change without notice.*

Chapter 1

Product introduction

Thank you for buying an ASUS® P5KPL-AM SE motherboard!

Before you start installing the motherboard, and hardware devices on it, check the items in your motherboard package. Refer to page ix for the list of accessories.



If any of the items is damaged or missing, contact your retailer.

1.1 Before you proceed

Take note of the following precautions before you install motherboard components or change any motherboard settings.



- Unplug the power cord from the wall socket before touching any component.
 - Use a grounded wrist strap or touch a safely grounded object or a metal object, such as the power supply case, before handling components to avoid damaging them due to static electricity
 - Hold components by the edges to avoid touching the ICs on them.
 - Whenever you uninstall any component, place it on a grounded antistatic pad or in the bag that came with the component.
 - Before you install or remove any component, ensure that the ATX power supply is switched off or the power cord is detached from the power supply. Failure to do so may cause severe damage to the motherboard, peripherals, or components.
-

Onboard LED

This motherboard comes with a standby power LED that lights up to indicate that the system is ON, in sleep mode, or in soft-off mode. This is a reminder that you must shut down the system and unplug the power cable before removing or plugging in any motherboard component. The illustration below shows the location of the onboard LED.

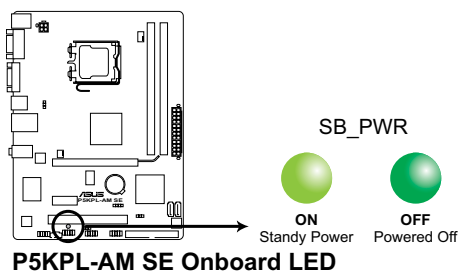

1.2 Motherboard overview

1.2.1 Motherboard layout



Ensure that you install the motherboard into the chassis in the correct orientation. The edge with external ports goes to the rear part of the chassis.

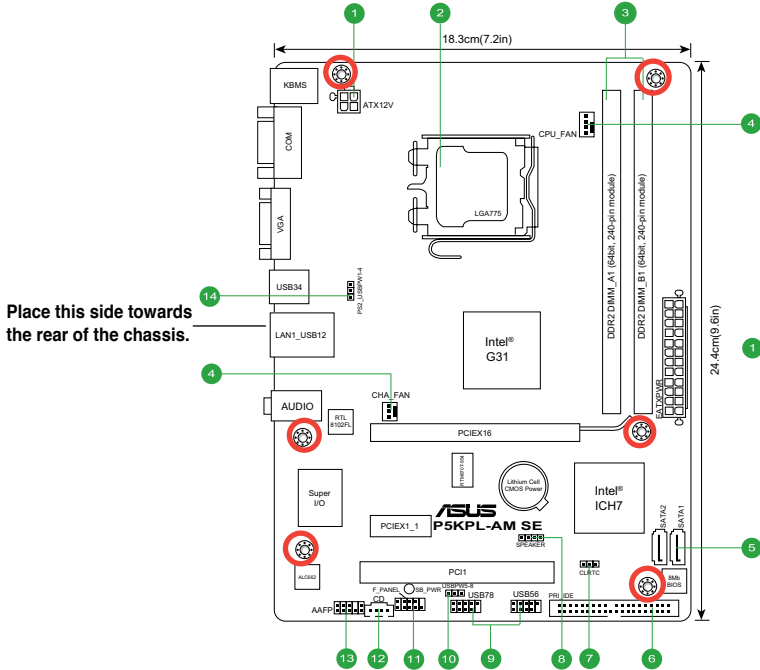

Place six screws into the holes indicated by circles to secure the motherboard to the chassis. **DO NOT** overtighten the screws! Doing so can damage the motherboard.

1.2.2 Layout contents

Connectors/Jumpers/Slots	Page	Connectors/Jumpers/Slots	Page
1. ATX power connectors (24-pin EATXPWR, 4-pin ATX12V)	1-13	9. USB connectors (10-1 pin USB56, USB 78)	1-11
2. LGA775 socket	1-3	10. USB device wake-up (3-pin USBPW 5-8)	1-7
3. DDR2 DIMM slots	1-3	11. System panel connector (10-1 pin F_PANEL)	1-14
4. CPU, CHA fan connectors (4-pin CPU_FAN, 3-pin CHA_FAN)	1-12	12. Optical drive audio connector (4-pin CD)	1-14
5. Serial ATA connectors (7-pin SATA1, SATA2)	1-10	13. Front panel audio connector (10-1 pin AAFF)	1-12
6. IDE connector (40-1 pin PRI_IDE)	1-11	14. Keyboard/mouse power (3-pin PS2_USBPW1-4)	1-9
7. Clear RTC RAM (3-pin CLRTC)	1-8		
8. Internal speaker connector (4-pin SPEAKER)	1-13		

1.3 Central Processing Unit (CPU)

The motherboard comes with a surface mount LGA775 socket designed for the Intel® Core™2 Quad / Core™2 Extreme / Core™2 Duo / Pentium® D / Pentium® 4 and Celeron® E1000 Series and Celeron 400 Series processors.



- Ensure that all power cables are unplugged before installing the CPU.



- Upon purchase of the motherboard, make sure that the PnP cap is on the socket and the socket contacts are not bent. Contact your retailer immediately if the PnP cap is missing, or if you see any damage to the PnP cap/socket contacts/motherboard components. ASUS will shoulder the cost of repair only if the damage is shipment/transit-related.
- Keep the cap after installing the motherboard. ASUS will process Return Merchandise Authorization (RMA) requests only if the motherboard comes with the cap on the LGA775 socket.
- The product warranty does not cover damage to the socket contacts resulting from incorrect CPU installation/removal, or misplacement/loss/incorrect removal of the PnP cap.

1.4 System memory

1.4.1 Overview

The motherboard comes with two Double Data Rate 2 (DDR2) Dual Inline Memory Modules (DIMM) sockets.

The figure illustrates the location of the DDR2 DIMM sockets:

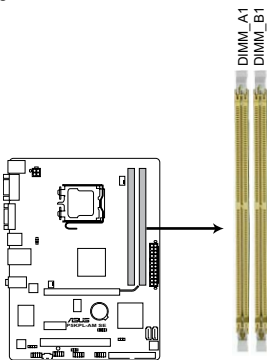

P5KPL-AM SE 240-pin DDR2 DIMM sockets

Channel	Sockets
Channel A	DIMM_A1
Channel B	DIMM_B1

1.4.2 Memory configurations

You may install 256MB, 512MB, 1GB, 2GB, and 4GB unbuffered ECC/non-ECC DDR2 DIMMs into the DIMM sockets.



- You may install varying memory sizes in Channel A and Channel B. The system maps the total size of the lower-sized channel for the dual-channel configuration. Any excess memory from the higher-sized channel is then mapped for single-channel operation.
- Always install DIMMs with the same CAS latency. For optimum compatibility, we recommend that you obtain memory modules from the same vendor.
- Due to the memory address limitation on 32-bit Windows OS, when you install 4GB or more memory on the motherboard, the actual usable memory for the OS can be about 3GB or less. For effective use of memory, we recommend that you install a 64-bit Windows OS when having 4GB or more memory installed on the motherboard.



- The default memory operation frequency depends on its SPD. Under the default state, some memory modules for overclocking may operate at a lower frequency than the vendor-marked value.
- For system stability, use a more efficient cooling system to support a full memory load (2 DIMMs) or overclocking conditions.

Qualified Vendors Lists (QVL)

DDR2 667 Qualified Vendors List

Size	Vendor	Model	CL	Brand	S / S / DS	Component	DIMM support	
							A*	B*
256MB	Kingston	KVR667D2N5/256	N/A	Elpida	SS	E2508AB-6E-E	•	•
256MB	Kingston	KVR667D2N5/256	N/A	Kingston	SS	D3216TL5AKL3U	•	•
256MB	Kingston	KVR667D2N5/256	N/A	Infineon	SS	HYB18T256800AF3SW65 33154	•	•
512MB	Kingston	KVR667D2N5/512	N/A	Kingston	SS	D6408TE8WL-27	•	•
512MB	Kingston	KVR667D2N5/512	N/A	Elpida	SS	E5108AGBG-6E-E	•	•
1G	Kingston	KVR667D2N5/1G	N/A	Kingston	DS	D6408TE8WL-3	•	•
1G	Kingston	KVR667D2N5/1G	N/A	Kingston	DS	D6408TEBGG13U	•	•
1G	Kingston	KVR667D2N5/1G	N/A	Elpida	DS	E5108AGBG-6E-E	•	•
512MB	Samsung	KR M378T6553CZ0-CE6	N/A	Samsung	SS	K4T51083QC	•	•
512MB	Samsung	KR M378T6453FZ0-CE6	N/A	Samsung	DS	K4T56083QF-ZCE6	•	•
512MB	Samsung	M378T6553CZ3-CE6	N/A	Samsung	SS	K4T51083QC-ZCE6	•	•
1G	Samsung	M378T2953CZ3-CE6	N/A	Samsung	DS	K4T51083QC-ZCE6	•	•
1G	Samsung	KR M378T2953CZ0-CE6	N/A	Samsung	DS	K4T51083QC-ZCE6	•	•
256MB	Qimonda	HY564T32000HU-3S-AA	N/A	Qimonda	SS	HYB18T512160AF-3SSSS17310	•	•
512MB	Qimonda	HY564T32000HU-3S-A	N/A	Qimonda	SS	HYB18T512800AF-3SSSS27416	•	•
512MB	Qimonda	HY564T64000HU-3S-A	N/A	Qimonda	SS	HYB18T512800AF3SFSS05346	•	•
1G	Qimonda	HY564T128020HU-3S-A	N/A	Qimonda	DS	HYB18T512800AF3SSSS28104	•	•
512MB	Corsair	VS512MB667D2	N/A	Corsair	SS	64M8CFEGPS0900647	•	•
512MB	Corsair	VS512MB667D2	N/A	Corsair	DS	MII10052532M8CEC	•	•
1G	Corsair	VS1GB667D2	N/A	Corsair	DS	MID095062864M8CEC	•	•
1G	Corsair	XMS2-5400	4	Corsair	DS	Heat-Sink Package	•	•
256MB	HY	HYMP532U64CP6-Y5 AB	5	Hynix	SS	HY5PS121621CFP-Y5	•	•
512MB	HY	HYMP564U64AP8-Y4 AA	N/A	Hynix	SS	HY5PS12821AFP-Y4	•	•
512MB	HY	HYMP564U64AP8-Y5 AA	N/A	Hynix	SS	HY5PS12821AFP-Y5	•	•
1G	HY	HYMP512U64AP8-Y5 AB	N/A	Hynix	DS	HY5PS12821AFP-Y5	•	•
1G	HY	HYMP512U64CP8-Y5 AB	5	Hynix	DS	HY5PS12521CFP-Y5	•	•
512MB	Kingmax	KLCC28F-A8EB5	N/A	Elpida	SS	E5108AE-6E-E	•	•
512MB	Kingmax	KLCC28F-A8KB5	N/A	Kingmax	SS	KKEA88B4LAUG-29DX	•	•
1G	Kingmax	KLCD48F-A8KB5	N/A	Kingmax	DS	KKEA88B4LAUG-29DX	•	•
512MB	Apacer	78.91092.420	N/A	Elpida	SS	E5108AE-6E-E	•	•
512MB	Apacer	AU512E667C5KBGC	5	Apacer	SS	AM4B5708MUJS7E0627F	•	•
512MB	Apacer	AU512E667C5KBGC	5	Apacer	SS	AM4B5708GQJS7E06332F	•	•
1G	Apacer	AU01GE667C5KBGC	N/A	Apacer	DS	AM4B5708GQJS7E0636B	•	•

(continued on the next page)

Size	Vendor	Model	CL	Brand	S S / DS	Component	DIMM support	
							A*	B*
1G	Apacer	78.01092.420	5	Elpida	DS	E5108AE-6E-E	*	*
1G	Apacer	AU01GE667C5KBGC	5	Apacer	DS	AM4B5708MJS7E0627B	*	*
512MB	ADATA	M20EL5G3H3160B1C0Z	N/A	Elpida	SS	E5108AE-6E-E	*	*
512MB	ADATA	M20AD5G3H3166H1C52	N/A	ADATA	SS	AD29608A8A-3EG20648	*	*
512MB	ADATA	M20AD5G3H3166H1C52	N/A	ADATA	SS	AD29608A8A-3EG20718	*	*
1G	ADATA	M20AD5G3I41761C52	N/A	ADATA	DS	AD29608A8A-3EG20645	*	*
512MB	VDATA	M2GVDSG3H31A411C52	N/A	VDATA	SS	VD29608A8A-3EG20615	*	*
512MB	VDATA	M2YVD5G3H31P411C52	N/A	VDATA	SS	VD29608A8A-3EG20627	*	*
512MB	VDATA	M2GVDSG3H166H1C52	N/A	VDATA	SS	VD29608A8A-3EG20637	*	*
1G	VDATA	M2GVDSG3I41P611C52	N/A	VDATA	DS	VD29608A8A-3EG20627	*	*
1G	VDATA	M2GVDSG3I41C411C52	N/A	VDATA	DS	VD29608A8A-3EG20620	*	*
1G	VDATA	M2GVDSG3I41761C52	N/A	VDATA	DS	VD29608A8A-3EG20641	*	*
512MB	PSC	AL6E8E63B-6E1K	5	PSC	SS	A3R12E3GEF637BLC5N	*	*
1G	PSC	AL7E8E63B-6E1K	5	PSC	DS	A3R12E3GEF637BLC5N	*	*
256MB	Nanya	NT256T64UH4A1FY-3C	N/A	Nanya	SS	NT5TU32M16AG-3C	*	*
512MB	Nanya	NT512T64U88A1BY-3C	N/A	Nanya	SS	NT5TU64M8AE-3C	*	*
512MB	MDT	MDT 512MB	4	MDT	SS	18D51280D-30648	*	*
1G	MDT	MDT 1024MB	4	MDT	DS	18D51200D-30646	*	*
1G	MDT	MDT 1024MB	4	MDT	DS	18D51280D-30646E	*	*
1G	PQI	DDR2-667U 1G	N/A	Hynix	DS	HY5PS12821BFP-E3 A	*	*
512MB	AENEON	AET660UD00-30DA98Z	N/A	AENEON	SS	AET93F30DA 0552	*	*
512MB	AENEON	AET660UD00-30DB97X	5	AENEON	SS	AET93R300B 0634	*	*
1G	AENEON	AET760UD00-30DA98Z	N/A	AENEON	DS	AET93F30DA8EE47414G 0540	*	*
1G	AENEON	AET760UD00-30DA98Z	N/A	AENEON	DS	AET93F30DA 0604	*	*
1G	AENEON	AET760UD00-30DB97X	5	AENEON	DS	AET93R300B 0639	*	*
512MB	TAKEMS	TMS51B264C081-665QI	5	takeMS	SS	MS18T51280-3	*	*
512MB	TAKEMS	TMS51B264C081-665AP	5	takeMS	SS	MS18T51280-3S0627D	*	*
1G	TAKEMS	TMS1GB264C081-665QI	5	takeMS	DS	MS18T51280-3	*	*
1G	TAKEMS	TMS1GB264C081-665AE	5	takeMS	DS	MS18T51280-3SEA07100	*	*
1G	TAKEMS	TMS1GB264C081-665AP	5	takeMS	DS	MS18T51280-3SP0717A	*	*
512MB	VERITECH	GTP512HLTM45EG	N/A	VERITECH	SS	VTD264M8PC6G01A164129621	*	*
1G	VERITECH	GTP01GHLTM55EG	N/A	VERITECH	DS	VTD264M8PC6G01A164129621	*	*
512MB	GEIL	GX21GB5300DC	4	GEIT	SS	Heat-Sink Package	*	*
512MB	TEAM	TVDD512M667C5	N/A	TEAM	SS	T2D648MT-6	*	*
1G	TEAM	TVDD1.02M667C4	N/A	TEAM	DS	T2D648PT-6	*	*
512MB	Century	CENTURY 512MB	N/A	Nanya	SS	NT5TU64M8AE-3C	*	*
512MB	Century	CENTURY 512MB	N/A	Hynix	SS	HY5PS12821AFP-Y5	*	*
1G	Century	CENTURY 1G	N/A	Hynix	DS	HY5PS12821AFP-Y5	*	*
1G	Century	CENTURY 1G	N/A	Nanya	DS	NT5TU64M8AE-3C	*	*
512MB	KINGBOX	512MB 667MHz	N/A	KINGBOX	SS	EPD264082200-4	*	*
1G	KINGBOX	DDRII 1G 667MHz	N/A	KINGBOX	DS	EPD264082200-4	*	*

DDR2 800 Qualified Vendors List

Size	Vendor	Model	CL	Brand	S S / DS	Component	DIMM support	
							A*	B*
2G	Apacer	78.A1GA0.9K4	5	Apacer	DS	AM4B5808CQJS8E0740E	*	*
2G	PSC	AL8E8F79C-8E1	5	PSC	DS	A3R1GE3CF7F34MAA0E	*	*
2G	AENEON	AET860UD00-25DC08X	5	AENEON	DS	AET03R250C 0732	*	*
2G	G.SKILL	F2-6400CL5D-4GBPO	5	G.SKILL	DS	Heat-Sink Package	*	*
512MB	Kingston	KVR800D2N5/512	N/A	Samsung	SS	K4T51083QC-ZCE7	*	*
512MB	Kingston	KVR800D2N5/512	N/A	Promos	SS	V59C1512804QBF25S0054707PEBPA	*	*
1G	Kingston	KVR800D2N5/1G	N/A	Samsung	DS	K4T51083QC-ZCE7	*	*
1G	Kingston	KHX6400D2LL/1G	N/A	Kingston	DS	Heat-Sink Package	*	*
1G	Kingston	KVR800D2N5/1G	N/A	Nanya	DS	NT5TU64M8BE-25C62321800CP	*	*
1G	Kingston	KHX6400D2LK2/1GN	N/A	Kingston	DS	Heat-Sink Package	*	*
2G	Kingston	KHX6400D2K2/2G	N/A	Kingston	DS	Heat-Sink Package	*	*
512MB	Samsung	KR M378T6553CZ3-CE7	N/A	Samsung	SS	K4T51083QC-ZCE7	*	*

(continued on the next page)

Size	Vendor	Model	CL	Brand	SS/ DS	Component	DIMM support	
							A*	B*
1G	Samsung	KR M378T2953CZ3-CE7	N/A	Samsung	DS	K4T51083QC-ZCE7	*	*
256MB	Qimonda	HYS64T32001HU-2.5-A	N/A	Qimonda	SS	HYB18T256800AF25SS549313	*	*
512MB	Qimonda	HYS64T64020HU-2.5-A	N/A	Qimonda	DS	HYB18T256800AF25SS525063	*	*
1G	Corsair	CM2X1024-6400	5	Corsair	DS	Heat-Sink Package	*	*
1G	Corsair	XMS2-6400	4	Corsair	DS	Heat-Sink Package	*	*
1G	Corsair	XMS2-6400	5	Corsair	DS	Heat-Sink Package	*	*
512MB	HY	HYMP564U64AP8-S6 AA	N/A	Hynix	SS	HY5PS12821AFP-S6	*	*
512MB	HY	HYMP564U64BP8-S5 AB	N/A	Hynix	SS	HY5PS12821BFP-S5	*	*
512MB	HY	HYMP564U64CP8-S5 AB	5	Hynix	SS	HY5PS12821CFP-S5	*	*
1G	HY	HYMP512U64AP8-S6 AA	N/A	Hynix	DS	HY5PS12821AFP-S6	*	*
1G	HY	HYMP512U64BP8-S5 AB	5	Hynix	DS	HY5PS12821BFP-S5	*	*
1G	HY	HYMP512U64CP8-S5 AB	5	Hynix	DS	HY5PS12821CFP-S5	*	*
2G	Apacer	AHU02GE800CSN1C	5	Apacer	DS	Heat-Sink Package	*	*
512MB	ADATA	M20AD6G3H31601IE58	N/A	ADATA	SS	AD29608A8A-25EG80720	*	*
512MB	VDATA	M2GVD6G3H31601IE53	N/A	VDATA	SS	VD29608A8A-25EG30648	*	*
1G	VDATA	M2GVD6G3I41701IE53	N/A	VDATA	DS	VD29608A8A-25EG30647	*	*
512MB	PSC	AL6E8E63B-8E1K	5	PSC	SS	A3R12E3HEFF641B9A05	*	*
1G	PSC	AL7E8E63B-8E1K	5	PSC	DS	A3R12E3HEFF641B9A05	*	*
512MB	AENEON	AET660UD00-25DB98X	N/A	AENEON	SS	AET93F25DB 0621	*	*
1G	AENEON	AET760UD00-25DB97X	5	AENEON	DS	AET93R25DB 0640	*	*
512MB	SIS	SLY264M8-JGE-3	N/A	SIS	SS	DDR1I6408-8E 7212	*	*
1G	SIS	SLY264M8-JGE-3	N/A	SIS	DS	DDR1I6408-8E 7301	*	*
512MB	TAKEMS	TMS51B264C081-805EP	5	takeMS	SS	MS18T51280-2.5P0710	*	*
1G	TAKEMS	TMS1GB264C081-805EP	5	takeMS	DS	MS18T51280-2.5P0716	*	*
512MB	VERITECH	GTU512HLTXX4EG	N/A	Veritech	SS	VTD264M8PC4G03A169045648	*	*
1G	VERITECH	GTU01GHLTXX4EG	N/A	Veritech	DS	VTD264M8PC4G03A169045648	*	*
1G	UMAX	1GB.DDR2.PC6400	5	UMAX	DS	U2S12D30TP-8E	*	*

DDR2 1066 Qualified Vendors List

Size	Vendor	Model	CL	Brand	SS/DS	Component	DIMM support	
							A*	B*
512MB	Kingston	KHX8500D2/512	N/A	Kingston	SS	Heat-Sink Package	*	*
512MB	Kingston	KHX8500D2K2/1GN	N/A	Kingston	SS	Heat-Sink Package	*	*
1G	Kingston	KHX8500D2K2/2GN	N/A	Kingston	SS	Heat-Sink Package	*	*
512MB	Apacer	78.9AG9S.9L5	5	Apacer	SS	Heat-Sink Package	*	*
1G	Apacer	78.0AG9S.BN4	5	Apacer	DS	Heat-Sink Package	*	*
1G	Corsair	CM2X1024-8500C5	N/A	Corsair	DS	Heat-Sink Package	*	*
1G	Corsair	CM2X1024-8500C5D	5	Corsair	DS	Heat-Sink Package	*	*
512MB	ADATA	M2OMIDG3H3160INC5Z	5	ADATA	SS	Heat-Sink Package	*	*
1G	ADATA	M2OMIDG314720INC5Z	5	ADATA	DS	Heat-Sink Package	*	*
512MB	AENEON	AXT760UD00-19DC97X	5	AENEON	SS	Heat-Sink Package	*	*
1G	AENEON	AXT760UD00-19DC97X	5	AENEON	DS	Heat-Sink Package	*	*
1G	OCZ	OCZ2N1066SR2DK	N/A	OCZ	DS	Heat-Sink Package	*	*
1G	OCZ	OCZ2N10662GK	N/A	OCZ	DS	Heat-Sink Package	*	*
512MB	Kingbox	EP512D21066PS	N/A	Micron	SS	6QD22D9GCT	*	*



Visit the ASUS website at (www.asus.com) for the latest QVL.



SS - Single-sided / DS - Double - sided

DIMM support:

- **A*:** Supports one module inserted into any slot as Single-channel memory configuration.
- **B*:** Supports one pair of modules inserted into the yellow slots as one pair of Dual-channel memory configuration.

1.5 Expansion slots

In the future, you may need to install expansion cards. Refer to the technical documentation that come with your expansion card for installation details.



Ensure to unplug the power cord before adding or removing expansion cards. Failure to do so may cause you physical injury and damage motherboard components.

1.5.1 PCI slot

The PCI slot supports cards such as LAN cards, SCSI cards, USB cards, and other cards that comply with the PCI specifications.

1.5.2 PCI Express x1 slot

This motherboard supports PCI Express x1 network cards, SCSI cards, and other cards that comply with the PCI Express specifications.

1.5.3 PCI Express x16 slot

This motherboard supports PCI Express x16 graphics cards that comply with the PCI Express specifications.

1.6 Jumpers

1. USB device wake-up (3-pin USBPW5-8)

Set this to +5V to wake up the computer from S1 sleep mode (CPU stopped, DRAM refreshed, system running in low power mode) using the connected USB devices. Set to +5VSB to wake up from S3 and S4 sleep modes (no power to CPU, DRAM in slow refresh, power supply in reduced power mode).

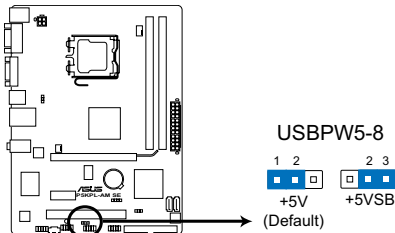

P5KPL-AM SE USB Device Wake Up



- The USB device wake-up feature requires a power supply that can provide 500mA on the +5VSB lead for the USB port. Otherwise, the system would not power up.
- The total current consumed must NOT exceed the power supply capability (+5VSB) whether under normal condition or in sleep mode.

2. Clear RTC RAM (CLRRTC)

This jumper allows you to clear the Real Time Clock (RTC) RAM in CMOS. You can clear the CMOS memory of date, time, and system setup parameters by erasing the CMOS RTC RAM data. The onboard button cell battery powers the RAM data in CMOS, which include system setup information such as system words.

To erase the RTC RAM:

1. Turn OFF the computer and unplug the power cord.
2. Remove the onboard battery.
3. Move the jumper cap from pins 1-2 (default) to pins 2-3. Keep the cap on pins 2-3 for about 5~10 seconds, then move the cap back to pins 1-2.
4. Reinstall the battery.
5. Plug the power cord and turn ON the computer.
6. Hold down the key during the boot process and enter BIOS setup to re-enter data.



Except when clearing the RTC RAM, never remove the cap on CLRRTC jumper default position. Removing the cap will cause system boot failure!



- If the steps above do not help, remove the onboard battery and move the jumper again to clear the CMOS RTC RAM data. After the CMOS clearance, reinstall the battery.
 - You do not need to clear the RTC when the system hangs due to overclocking. For system failure due to overclocking, use the CPU Parameter Recall (C.P.R.) feature. Shut down and reboot the system, then the BIOS automatically resets the parameter settings to default values.
 - Due to the chipset limitation, AC power off is required before you use the C.P.R. function. You must turn off and on the power supply or unplug and plug the power cord before rebooting the system.
-

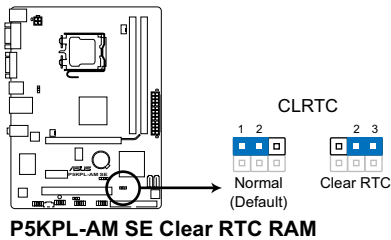

3. Keyboard/mouse power (3-pin PS2_USBPW1-4)

This jumper allows you to enable or disable the keyboard/mouse and USB port 5-6 wake-up feature. When you set this jumper to pins 2-3 (+5VSB), you can wake up the computer by pressing a key on the keyboard (the default is the Space Bar), clicking the mouse, or using a USB device. This feature requires an ATX power supply that can supply at least 1A on the +5VSB lead, and a corresponding setting in the BIOS. The USBPW56 jumper is for the rear USB ports.

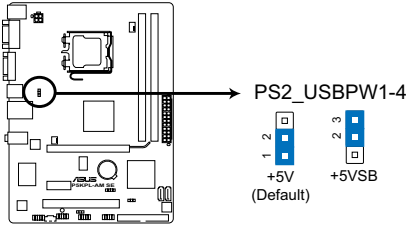

P5KPL-AM SE Keyboard Power Setting

1.7 Connectors

1.7.1 Rear panel ports

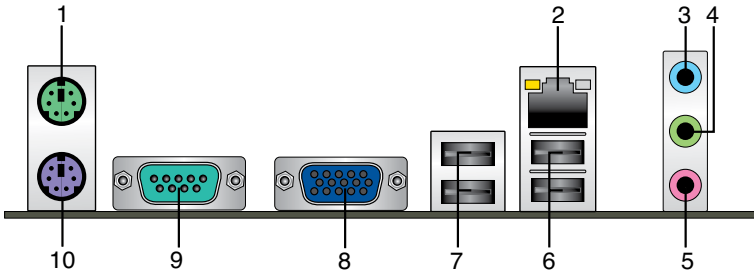

1. **PS/2 mouse port (green).** This port is for a PS/2 mouse.
2. **LAN (RJ-45) port.** Supported by Realtek 10/100 LAN controller, this port allows 10/100 connection to a Local Area Network (LAN) through a network hub. Refer to the table below for the LAN port LED indications.

LAN port LED indications

ACT LED		Speed LED	
Status	Description	Status	Description
OFF	No link	OFF	No link
Blink	Data activity	OFF	10M
Blink	Data activity	Orange	100M

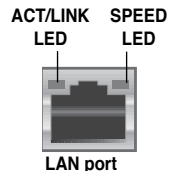

- Line In port (light blue).** This port connects to the tape, CD, DVD player, or other audio sources.
- Line Out port (lime).** This port connects to a headphone or a speaker. In 4-channel and 6-channel configuration, the function of this port becomes Front Speaker Out.
- Microphone port (pink).** This port connects to a microphone.



Refer to the audio configuration table below for the function of the audio ports in 2, 4, or 6-channel configuration.

Audio 2, 4, 6-channel configuration

Port	Headset 2-channel	4-channel	6-channel
Light Blue	Line In	Line In	Line In
Lime	Line Out	Front Speaker Out	Front Speaker Out
Pink	Mic In	Mic In	Mic In

- USB 2.0 ports 1 and 2.** These two 4-pin Universal Serial Bus (USB) ports connect to USB 2.0 devices.
- USB 2.0 ports 3 and 4.** These two 4-pin Universal Serial Bus (USB) ports connect to USB 2.0 devices.
- Video Graphics Adapter (VGA) port.** This 15-pin port is for a VGA monitor or other VGA-compatible devices.
- COM port.** This 9-pin COM1 port is for pointing devices or other serial devices.
- PS/2 Keyboard port.** This port is for a PS/2 keyboard.

1.7.2 Internal connectors

1. ICH7 Serial ATA connectors (7-pin SATA1, SATA2)

These connectors are for the Serial ATA signal cables for Serial ATA hard disk drives.

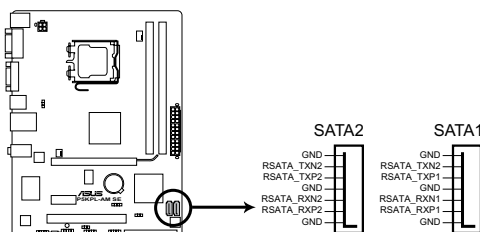

P5KPL-AM SE SATA connectors (ICH7)

right angle side



Connect the right-angle side of SATA signal cable to SATA device. You may also connect the right-angle side of SATA cable to the onboard SATA port to avoid mechanical conflict with huge graphics cards.

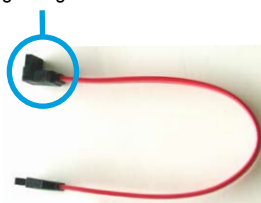

2. IDE connector (40-1 pin PRI_IDE)

The onboard IDE connector is for the Ultra DMA 100/66/33 signal cable. There are three connectors on each Ultra DMA 100/66/33 signal cable: blue, black, and gray. Connect the blue connector to the motherboard's IDE connector, then select one of the following modes to configure your device.

	Driver Jumper setting	Mode of device(s)	Cable connector
Single device	Cable-Selected or Master	-	Black
Two devices	Cable-Select	Master	Black
		Slave	Gray
	Master	Master	Black or gray
	Slave	Slave	



- Pin 20 on the IDE connector is removed to match the covered hole on the Ultra DMA cable connector. This prevents incorrect insertion when you connect the IDE cable.
- Use the 80-conductor IDE cable for Ultra DMA 133/100/66 IDE devices.

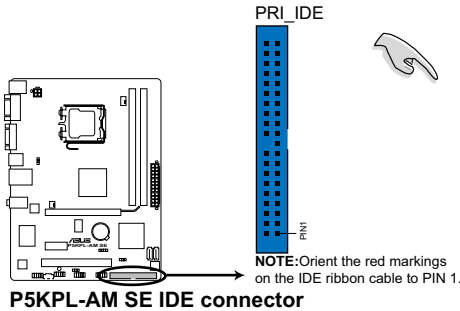

If any device jumper is set as "Cable-Select," ensure that all other device jumpers have the same setting.

3. USB connectors (10-1 pin USB56, USB78)

These connectors are for USB 2.0 ports. Connect the USB module cable to any of these connectors, then install the module to a slot opening at the back of the system chassis. These USB connectors comply with USB 2.0 specification that supports up to 480 Mbps connection speed.

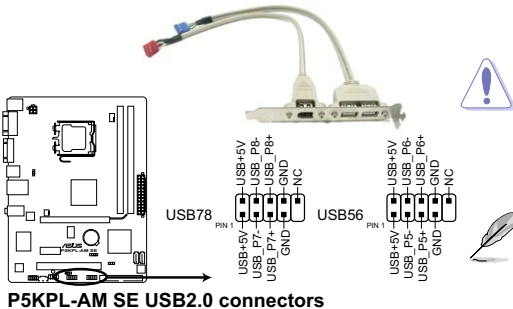

Never connect a 1394 cable to the USB connectors. Doing so will damage the motherboard!

The USB module cable is purchased separately.

4. Front panel audio connector (10-1 pin AAFP)

This connector is for a chassis-mounted front panel audio I/O module that supports either HD Audio or legacy AC'97 audio standard.

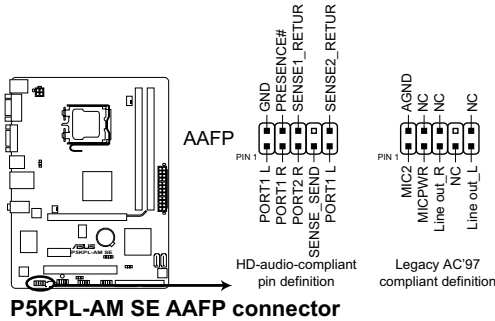

- We recommend that you connect a high-definition front panel audio module to this connector to avail of the motherboard's high-definition audio capability.
- If you want to connect a high-definition front panel audio module to this connector, set the **Front Panel Type** item in the BIOS setup to **[HD Audio]**; if you want to connect an AC'97 front panel audio module to this connector, set the item to **[AC97]**. By default, this connector is set to **[HD Audio]**.

5. CPU, chassis fan connectors (4-pin CPU_FAN, 3-pin CHA_FAN)

The fan connectors support cooling fans of 350 mA ~ 2000 mA (24 W max.) or a total of 1 A ~ 7 A (84 W max.) at +12V. Connect the fan cables to the fan connectors on the motherboard, ensuring that the black wire of each cable matches the ground pin of the connector.



Do not forget to connect the fan cables to the fan connectors. Insufficient air flow inside the system may damage the motherboard components. These are not jumpers! Do not place jumper caps on the fan connectors!

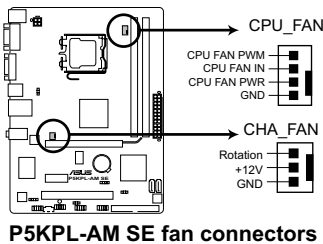

Only the CPU_FAN connector support the ASUS Advanced Q-Fan feature.

6. ATX power connectors (24-pin EATXPWR, 4-pin ATX12V)

These connectors are for ATX power supply plugs. The power supply plugs are designed to fit these connectors in only one orientation. Find the proper orientation and push down firmly until the connectors completely fit.

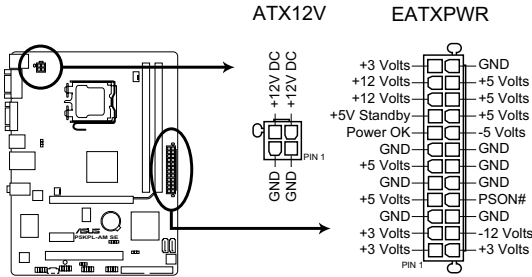

P5KPL-AM SE ATX power connectors



- For a fully configured system, we recommend that you use a power supply unit (PSU) that complies with EATX 12 V Specification 2.0 (or later version) and provides a minimum power of 400 W.
- Do not forget to connect the 4-pin ATX12V power plug. Otherwise, the system will not boot.
- We recommended that you use a PSU with a higher power output when configuring a system with more power-consuming devices. The system may become unstable or may not boot up if the power is inadequate.

7. Speaker connector (4-pin SPEAKER)

This 4-pin connector is for the chassis-mounted system warning speaker. The speaker allows you to hear system beeps and warnings.

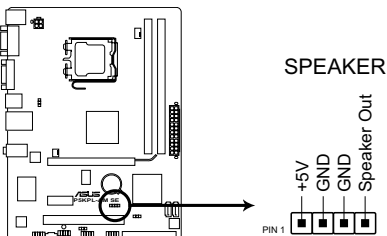

P5KPL-AM SE Speaker Out Connector

8. System panel connector (10-1 pin F_PANEL)

This connector supports several chassis-mounted functions.

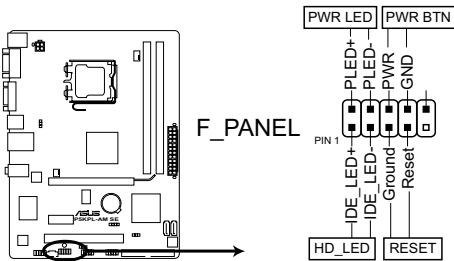

P5KPL-AM SE System panel connector

- **System power LED (2-pin PWRLED)**

This 2-pin connector is for the system power LED. Connect the chassis power LED cable to this connector. The system power LED lights up when you turn on the system power, and blinks when the system is in sleep mode.

- **Hard disk drive activity LED (2-pin +HDLED)**

This 2-pin connector is for the HDD Activity LED. Connect the HDD Activity LED cable to this connector. The IDE LED lights up or flashes when data is read from or written to the HDD.

- **ATX power button/soft-off button (2-pin PWRBTN)**

This connector is for the system power button. Pressing the power button turns the system on or puts the system in sleep or soft-off mode depending on the BIOS settings. Pressing the power switch for more than four seconds while the system is ON turns the system OFF.

- **Reset button (2-pin RESET)**

This 2-pin connector is for the chassis-mounted reset button for system reboot without turning off the system power.

9. Optical drive audio connector (4-pin CD)

These connectors allow you to receive stereo audio input from sound sources such as a CD-ROM, TV tuner, or MPEG card.

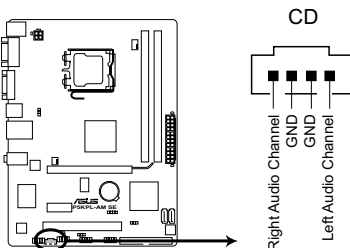

P5KPL-AM SE Internal audio connector

1.8 Software support

1.8.1 Installing an operating system

This motherboard supports Windows® XP/Vista Operating Systems (OS). Always install the latest OS version and corresponding updates to maximize the features of your hardware.



- Motherboard settings and hardware options vary. Use the setup procedures presented in this section for reference only. Refer to your OS documentation for detailed information.
- Ensure that you install Windows® XP Service Pack 1 or later versions before installing the drivers for better compatibility and system stability.

1.8.2 Support DVD information

The Support DVD that comes with the motherboard package contains the drivers, software applications, and utilities that you can install to avail all motherboard features.

To run the Support DVD

Place the Support DVD to the optical drive. The DVD automatically displays the Drivers menu if Autorun is enabled in your computer.

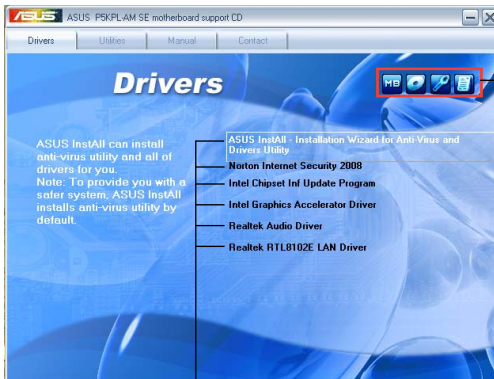

Click an icon to display Support DVD/ motherboard information

Click an item to install



If Autorun is NOT enabled in your computer, browse the contents of the Support DVD to locate the file ASSETUP.EXE from the BIN folder. Double-click the ASSETUP.EXE to run the DVD.

Chapter 2

BIOS information

2.1 Managing and updating your BIOS



Save a copy of the original motherboard BIOS file to a bootable USB flash disk in case you need to restore the BIOS in the future. Copy the original motherboard BIOS using the ASUS Update utility..

2.1.1 ASUS Update utility

The ASUS Update is a utility that allows you to manage, save, and update the motherboard BIOS in Windows® environment.



- ASUS Update requires an Internet connection either through a network or an Internet Service Provider (ISP).
 - This utility is available in the Support DVD that comes with the motherboard package.
-

Installing ASUS Update:

1. Place the Support DVD into the optical drive. The **Drivers** menu appears.
2. Click the **Utilities > Install ASUS Update**. Follow the onscreen instructions.



Quit all Windows® applications before you update the BIOS using this utility.

Updating the BIOS:

1. Click **Start > Programs > ASUS > ASUS Update > ASUS Update**.
2. From the dropdown list, select any of the updating process:

Updating from the Internet

- a. Select Update BIOS from the Internet, then click **Next**.
- b. Select the ASUS FTP site nearest you to avoid network traffic, or click **Auto Select** then click **Next**.
- c. Download the BIOS file from the ftp site, then click **Next**.



The ASUS Update utility is capable of updating itself through the Internet. Always update the utility to avail all its features.

Updating from a BIOS file

- a. Select Update BIOS from a file, then click **Next**.
 - b. Locate the BIOS file from the **Open** windows, then click **Open**.
3. Follow the onscreen instructions to complete the update process.

2.1.2 ASUS EZ Flash 2 utility

ASUS EZ Flash 2 allows you to update the BIOS without having to use a bootable floppy disk and a DOS-based utility.



Download the latest BIOS file for this motherboard from the ASUS website at www.asus.com.

To update the BIOS using EZ Flash 2.

1. Insert the USB flash disk that contains the BIOS file to a USB port, then launch EZ Flash 2 in either of these two ways:

- (1) Press **<Alt> + <F2>** during POST to display the following:

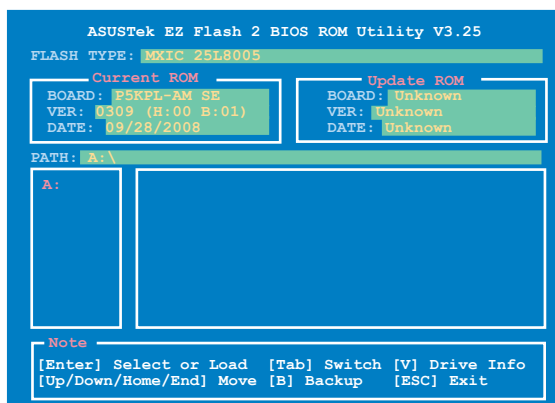

- (2) Enter BIOS setup program. Go to the **Tools** menu to select **EZ Flash 2** and press **<Enter>** to enable it.

Press **<Tab>** to switch between drives until the correct BIOS file is found.

2. Select the correct BIOS file then press **<Enter>**, EZ Flash 2 updates the BIOS and automatically reboots the system when done.



- This function supports USB flash disks with **FAT 32/16** format and single partition only.
 - **DO NOT** shut down or reset the system while updating the BIOS to prevent system boot failure!
-

2.1.3 ASUS CrashFree BIOS 3 utility

The ASUS CrashFree BIOS 3 is an auto recovery tool that allows you to restore the BIOS file when it fails or gets corrupted during the updating process. You can update a corrupted BIOS file using the motherboard Support DVD or a USB flash disk that contains the updated BIOS file.



-
- Prepare the motherboard Support DVD or the USB flash disk containing the updated motherboard BIOS before using this utility.
 - Always connect the SATA cable to the SATA1 / SATA2 connector; otherwise, the utility will not function.
-

Recovering the BIOS from the Support DVD or a USB flash disk:

1. Turn on the system.
2. Insert the Support DVD or a USB flash disk with the BIOS file to your computer.
3. The utility displays the following message and automatically checks the Support DVD and the USB flash disk for the BIOS file.

```
Bad BIOS checksum. Starting BIOS recovery...
Checking for CD-ROM...
```

When found, the utility reads the BIOS file and starts flashing the corrupted BIOS file.

```
Bad BIOS checksum. Starting BIOS recovery...
Checking for CD-ROM...
CD-ROM found!
Reading file "P5KPLAMS.ROM". Completed.
Start Erasing...!
Start Programming...!
```

4. Restart the system after the utility completes the updating process.



-
- Only the USB flash disk with FAT 32/16 format and single partition supports ASUS CrashFree BIOS 3. The device size should be smaller than 8GB.
 - **DO NOT** shut down or reset the system while updating the BIOS! Doing so can cause system boot failure!
-



-
- The utility automatically checks the optical drive first. If no optical drive is found, the utility automatically checks the USB flash disk.
 - The recovered BIOS may not be the latest BIOS version for this motherboard. Visit the ASUS website at www.asus.com to download the latest BIOS file.
-

2.2 BIOS setup program

Use the BIOS Setup program when you are installing a motherboard, reconfiguring your system, or prompted to “Run Setup.” This section explains how to configure your system using this utility.

If you want to enter Setup after POST, reboot the system by doing any of the following procedures:

- Restart using the OS standard shut-down procedure.
- Press <Ctrl>+<Alt>+ simultaneously.
- Press the reset button on the system chassis.
- Press the power button to turn the system off then back on.



Using the **power button**, **reset button**, or the <Ctrl>+<Alt>+ keys to force reset from a running operating system can cause damage to your data or system. We recommend that you always shut down the system properly from the operating system.



- The default BIOS settings for this motherboard apply to most conditions to ensure optimum performance. If the system becomes unstable after changing any BIOS settings, load the default settings to ensure system compatibility and stability. Select the **Load Setup Defaults** item under the **Exit** menu. See section 2.8 **Exit menu**.
- The BIOS setup screens in this section are for reference only. They may not exactly match what you see on your screen.
- Visit the ASUS website at www.asus.com to download the latest BIOS file for this motherboard.

2.3 Main menu

When you enter the BIOS Setup program, the **Main** menu screen appears, giving you an overview of the basic system information.

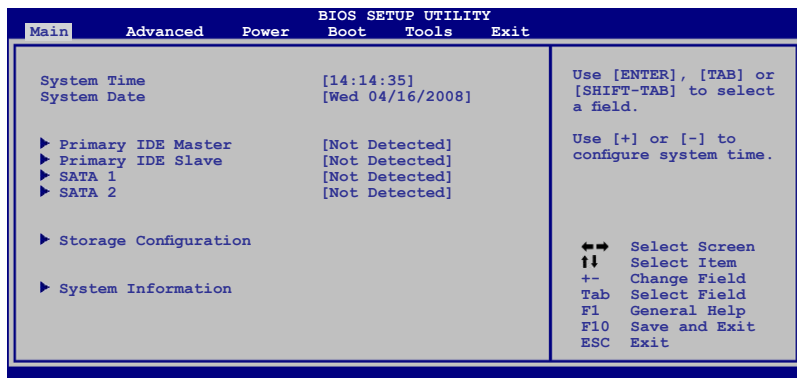

2.3.1 System Time [xx:xx:xx]

Allows you to set the system time.

2.3.2 System Date [Day xx/xx/xxxx]

Allows you to set the system date.

2.3.3 Primary IDE/SATA

While entering Setup, the BIOS automatically detects the presence of IDE/SATA devices. There is a separate sub-menu for each IDE/SATA device. Select a device item then press <Enter> to display the IDE/SATA device information.

The BIOS automatically detects the values opposite the dimmed items (Device, Vendor, Size, LBA Mode, Block Mode, PIO Mode, Async DMA, Ultra DMA, and SMART monitoring). These values are not user-configurable. These items show N/A if no IDE/SATA device is installed in the system.

Type [Auto]

Selects the type of IDE drive. Setting to **[Auto]** allows automatic selection of the appropriate IDE device type. Select **[CDROM]** if you are specifically configuring a CD-ROM drive. Select **[ARMD]** (ATAPI Removable Media Device) if your device is either a ZIP, LS-120, or MO drive. Configuration options: [Not Installed] [Auto] [CDROM] [ARMD]



This option only appears in Primary IDE Master/Slave.

LBA/Large Mode [Auto]

Enables or disables the LBA mode. Setting to Auto enables the LBA mode if the device supports this mode, and if the device was not previously formatted with LBA mode disabled. Configuration options: [Disabled] [Auto]

Block (Multi-sector Transfer) M [Auto]

Enables or disables data multi-sectors transfers. When set to Auto, the data transfer from and to the device occurs multiple sectors at a time if the device supports multi-sector transfer feature. When set to [Disabled], the data transfer from and to the device occurs one sector at a time. Configuration options: [Disabled] [Auto]

PIO Mode [Auto]

Selects the PIO mode.
Configuration options: [Auto] [0] [1] [2] [3] [4]

DMA Mode [Auto]

Selects the DMA mode. Configuration options: [Auto]

SMART Monitoring [Auto]

Sets the Smart Monitoring, Analysis, and Reporting Technology.
Configuration options: [Auto] [Disabled] [Enabled]

32Bit Data Transfer [Enabled]

Enables or disables 32-bit data transfer.
Configuration options: [Disabled] [Enabled]

2.3.4 Storage Configuration

The items in this menu allow you to set or change the configurations for the SATA devices installed in the system. Select an item then press <Enter> if you want to configure the item.

ATA/IDE Configuration [Enhanced]

Configuration options: [Disabled] [Compatible] [Enhanced]

Enhanced Mode Support On [S-ATA]

Configuration options: [S-ATA+P-ATA] [S-ATA] [P-ATA]

IDE Detect Time Out [35]

Selects the time out value for detecting ATA/ATAPI devices.

Configuration options: [0] [5] [10] [15] [20] [25] [30] [35]

2.3.5 System Information

This menu gives you an overview of the general system specifications. The BIOS automatically detects the items in this menu.

Bios Information

Displays the auto-detected BIOS information.

Processor

Displays the auto-detected CPU specification.

System Memory

Displays the auto-detected system memory.

2.4 Advanced menu

The **Advanced** menu items allow you to change the settings for the CPU and other system devices.



Take caution when changing the settings of the Advanced menu items. Incorrect field values can cause the system to malfunction.

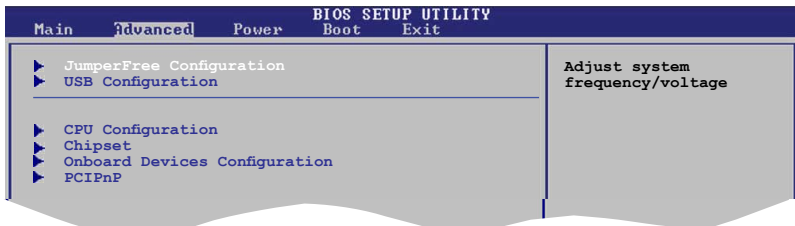

2.4.1 JumperFree Configuration

AI Overclocking [Auto]

Allows selection of CPU overclocking options to achieve desired CPU internal frequency.

Select either one of the preset overclocking configuration options:

Manual - allows you to individually set overclocking parameters.

Auto - loads the optimal settings for the system.

Overclock Profile - loads overclocking profiles with optimal parameters for stability when overclocking.

Test Mode - loads overclock (overclocking 5%) with spread spectrum.



The following item appears only when you set the AI Overclocking item to [Manual].

CPU Frequency [xxx]

Displays the frequency sent by the clock generator to the system bus and PCI bus. The value of this item is auto-detected by the BIOS. Use the <+> and <-> keys to adjust the CPU frequency. You can also type the desired CPU frequency using the numeric keypad. The values range from 133 to 600. Refer to the table below for the correct Front Side Bus and CPU External Frequency settings.



The following item appears only when you set the AI Overclocking item to [Overclock Profile].

Overclock Options [Overclock 5%]

Allows selection of CPU overclocking options to achieve desired CPU internal frequency. Configuration options: [Overclock 5%] [Overclock 10%] [Overclock 15%] [Overclock 20%] [Overclock 30%]

DRAM Frequency [Auto]

Allows you to set the DDR2 operating frequency.

Configuration options (for 1600MHz FSB CPU): [Auto] [800MHz] [960MHz] [1000MHz] [1200MHz]

Configuration options (for 1333MHz FSB CPU): [Auto] [667MHz] [800 MHz] [1000 MHz] [1100MHz]

Configuration options (for 1066MHz FSB CPU): [Auto] [667MHz] [800 MHz] [1066 MHz]

Configuration options (for 800MHz FSB CPU): [Auto] [667MHz] [800 MHz]



Selecting a very high DRAM frequency may cause the system to become unstable! If this happens, revert to the default setting.

1.8V Dual Over Voltage [Auto]

Manually set memory voltage or set to Auto for safe mode.

Configuration options: [Auto] [1.80V] [2.00V] [2.25V]

VTT_CPU Over Voltage [Auto]

Manually set FSB Termination Voltage or set to Auto for safe mode.

Configuration options: [Auto] [1.2V] [1.3V]

1.25V Over Voltage [Auto]

Manually set MCH Chipset Voltage or set to Auto for safe mode.

Configuration options: [Auto] [1.25V] [1.4V]

1.5V Over Voltage [Auto]

Manually set ICH Chipset Voltage or set to Auto for safe mode.

Configuration options: [Auto] [1.5V] [1.6V]

2.4.2 USB Configuration

The items in this menu allows you to change the USB-related features. Select an item then press <Enter> to display the configuration options.



The Module Version and USB Devices Enabled items show the auto-detected values. If no USB device is detected, the item shows None.

USB Functions [Enabled]

Allows you to enable or disable the USB functions. Configuration options: [Disabled] [Enabled]

USB 2.0 Controller [Enabled]

Allows you to enable or disable the USB 2.0 controller.

Configuration options: [Enabled] [Disabled]

Legacy USB Support [Auto]

Allows you to enable or disable support for legacy USB devices. Setting to **[Auto]** allows the system to detect the presence of USB devices at startup. If detected, the USB controller legacy mode is enabled. If no USB device is detected, the legacy USB support is disabled.

Configuration options: [Disabled] [Enabled] [Auto]

USB 2.0 Controller Mode [HiSpeed]

Allows you to set the USB 2.0 controller mode to HiSpeed (480 Mbps) or FullSpeed (12 Mbps). This item appears only when you enable the USB 2.0 Controller item.

Configuration options: [FullSpeed] [HiSpeed]

2.4.3 CPU Configuration

The items in this menu show the CPU-related information that the BIOS automatically detects.

CPU Ratio Setting [Auto]

Sets the ration between CPU core clock and the FSB frequency.



If an invalid ratio is set in CMOS, then the actual and set values may differ.



Key in ratio numbers directly.

C1É Support [Enabled]

Enable this item and users can configure the “Enhanced Halt State” function.

Configuration options: [Disabled] [Enabled]

Max CPUID Value Limit [Disabled]

Enable this item to boot legacy operating systems that cannot support CPUs with extended CPUID functions. Configuration options: [Disabled] [Enabled]

Vanderpool Technology [Enabled]

Enable this item when the processor supports Vanderpool technology. Users need to reset the computer to change the configuration of this item. Configuration options: [Disabled] [Enabled]

CPU TM function [Enabled]

Enables or disables Intel® CPU Thermal Monitor (TM2) function, a CPU overheating protection function. When enabled, the CPU core frequency and voltage is reduced when the CPU is overheats. Configuration options: [Enabled] [Disabled]

Execute Disable Bit [Enabled]

Allows you to Enable/disable Execute Disable Function.
Configuration options: [Disabled] [Enabled]

Intel® SpeedStep® Technology [Enabled]

Allows you to use the Enhanced Intel® SpeedStep® Technology. When set to **[Enabled]**, you can adjust the system power settings in the operating system to use the EIST feature. Set this item to **[Disabled]** if you do not want to use the EIST.
Configuration options: [Enabled] [Disabled]

2.4.4 Chipset

The **Chipset** menu allows you to change the advanced chipset settings. Select an item then press **<Enter>** to display the sub-menu.

North Bridge Configuration

Memory Remap Feature [Enabled]

Allows you to enable or disable the remapping of the overlapped PCI memory above the total physical memory. Enable this option only when you install 64-bit operating system.
Configuration options: [Disabled] [Enabled]

Configure DRAM Timing by SPD [Enabled]

Allows you to enable or disable configuring DRAM Timing by SPD.
Configuration options: [Enabled] [Disabled]

Initiate Graphic Adapter [PEG/PCI]

Allows you to decide which graphics controller to use as the primary boot device.
Configuration options: [IGD] [PCI/IGD] [PCI/PEG] [PEG/IGD] [PEG/PCI]

Internal Graphics Mode Select [Enabled, 8MB]

Allows you to select the amount of system memory used by the Internal graphics device.
Configuration options: [Disabled] [Enabled, 1MB] [Enabled, 8MB]
PEG Port Configuration

PEG Force x1 [Disabled]

Allows you to enable or disable the PEG Force x 1. Configuration options: [Enabled] [Disabled]

Video Function Configuration

DVMT Mode Select [DVMT Mode]

Allows you to select the DVMT Mode. Configuration options: [Fixed Mode] [DVMT Mode]

DVMT/FIXED Memory [256MB]

Allows you to select the amount of the DVMT/FIXED Memory. Configuration options: [128MB] [256MB] [Maximum DVMT]

South Bridge Configuration

Audio Controller [Azalia]

Allows you to set the audio controller. Configuration options: [Azalia] [All Disabled]

Front Panel Support Type [HD Audio]

Allows you to select the front panel support type. If High Definition Audio Front Panel used, please set HD Audio mode. Configuration options: [AC97] [HD Audio]

2.4.5 Onboard Devices Configuration

Onboard PCIE 10/100M LAN [Enabled]

Allows you to enable or disable the onboard LAN controller.

Configuration options: [Enabled] [Disabled]

LAN Option ROM [Disabled]

Allows you to enable or disable the boot ROM in the onboard LAN controller. This item appears only when the Onboard LAN item is set to Enabled. Configuration options: [Disabled] [Enabled]

Serial Port1 Address [3F8/IRQ4]

Allows you to select the Serial Port1 base address.

Configuration options: [Disabled] [3F8/IRQ4] [2F8/IRQ3] [3E8/IRQ4] [2E8/IRQ3]

2.4.6 PCI PnP

The PCI PnP menu items allow you to change the advanced settings for PCI/PnP devices.

The menu includes setting IRQ and DMA channel resources for either PCI/PnP or legacy ISA devices, and setting the memory size block for legacy ISA devices.



Take caution when changing the settings of the PCI PnP menu items. Incorrect field values can cause the system to malfunction.

Plug and Play O/S [No]

When set to [No], BIOS configures all the devices in the system. When set to [Yes] and if you install a Plug and Play operating system, the operating system configures the Plug and Play devices not required for boot.

Configuration options: [No] [Yes]

PCI Latency Timer [64]

Allows you to select the value in units of PCI clocks for the PCI device latency timer register.

Configuration options: [32] [64] [96] [128] [160] [192] [224] [248]

Allocate IRQ to PCI VGA [Yes]

When set to [Yes], BIOS assigns an IRQ to PCI VGA card if the card requests for an IRQ.

When set to [No], BIOS does not assign an IRQ to the PCI VGA card even if requested.

Configuration options: [Yes] [No]

Palette Snooping [Disabled]

When set to [Enabled], the palette snooping feature informs the PCI devices that an ISA graphics device is installed in the system so that the latter can function correctly.

Configuration options: [Disabled] [Enabled]

IRQ-xx assigned to [PCI Device]

When set to [PCI Device], the specific IRQ is free for use of PCI/PnP devices. When set to [Reserved], the IRQ is reserved for legacy ISA devices.

Configuration options: [PCI Device] [Reserved]

2.5 Power menu

The Power menu items allow you to change the settings for the Advanced Power Management (APM). Select an item then press **<Enter>** to display the configuration options.

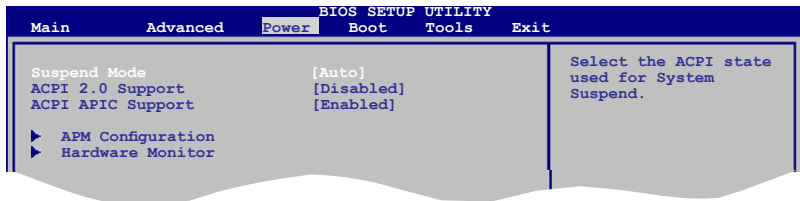

2.5.1 Suspend Mode [Auto]

Allows you to select the Advanced Configuration and Power Interface (ACPI) state to be used for system suspend. Configuration options: [S1 (POS) Only] [S3 Only] [Auto]

[S1(POS) Only] - Enables the system to enter the ACPI S1 (Power on Suspend) sleep state. In S1 sleep state, the system appears suspended and stays in a low power mode. The system can be resumed at any time.

[S3 Only] - Enables the system to enter the ACPI S3 (Suspend to RAM) sleep state (default). In S3 sleep state, the system appears to be off and consumes less power than in the S1 state. When signaled by a wake-up device or event, the system resumes to its working state exactly where it was left off.

[Auto] - Detected by OS.

2.5.2 ACPI 2.0 Support [Disabled]

Allows you to add more tables for Advanced Configuration and Power Interface (ACPI) 2.0 specifications. Configuration options: [Disabled] [Enabled]

2.5.3 ACPI APIC Support [Enabled]

Allows you to enable or disable the Advanced Configuration and Power Interface (ACPI) support in the Advanced Programmable Interrupt Controller (APIC). When set to **Enabled**, the ACPI APIC table pointer is included in the RSDT pointer list.

Configuration options: [Disabled] [Enabled]

2.5.4 APM Configuration

Restore on AC Power Loss [Power Off]

When set to Power Off, the system goes into off state after an AC power loss. When set to Power On, the system goes on after an AC power loss. When set to Last State, the system goes into either off or on state, whatever the system state was before the AC power loss.

Configuration options: [Power Off] [Power On] [Last State]

Power On By RTC Alarm [Disabled]

Disable/Enable RTC to generate a wake event. Configuration options: [Disabled] [Enabled]



The computer cannot receive or transmit data until the computer and applications are fully running. Thus, connection cannot be made on the first try. Turning an external modem off and then back on while the computer is off causes an initialization string that turns the system power on.

Power On By External Modems [Disabled]

Disable/Enable RI to generate a wake event. Configuration options: [Disabled] [Enabled]

Power On By PCI Devices [Disabled]

Disable/Enable PME to generate a wake event. Configuration options: [Disabled] [Enabled]

Power On By PCIE Devices [Disabled]

Configuration options: [Disabled] [Enabled]

Power On By PS/2 Keyboard [Disabled]

Allows you to use specific keys on the keyboard to turn on the system. This feature requires an ATX power supply that provides at least 1A on the +5VSB lead. Configuration options: [Disabled] [Space Bar] [Ctrl-Esc] [Power Key]

Power On By PS/2 Mouse [Disabled]

When set to [Enabled], this parameter allows you to use the PS/2 mouse to turn on the system. This feature requires an ATX power supply that provides at least 1A on the +5VSB lead. Configuration options: [Disabled] [Enabled]

2.5.5 Hardware Monitor

CPU Temperature [xxx°C/xxx°F]

The onboard hardware monitor automatically detects and displays the CPU temperatures. Select **Ignored** if you do not wish to display the detected temperatures.

MB Temperature [xxx°C/xxx°F]

The onboard hardware monitor automatically detects and displays the motherboard temperatures. Select **Ignored** if you do not wish to display the detected temperatures.

CPU Fan Speed (RPM) [xxxxRPM] or [N/A] or [Ignored]

The onboard hardware monitor automatically detects and displays the CPU fan speed in rotations per minute (RPM). If the fan is not connected to the motherboard, the field shows N/A. Select **Ignored** if you do not wish to display the detected speed.

CPU Q-Fan Control [Disabled]

Allows you to enable or disable the Q-Fan control. Configuration options: [Disabled] [Enabled]

Chassis Fan Speed [xxxxRPM] or [N/A] or [Ignored]

The onboard hardware monitor automatically detects and displays the chassis fan speed in rotations per minute (RPM). If the fan is not connected to the chassis, the specific field shows N/A. Select **Ignored** if you do not wish to display the detected speed.

VCORE Voltage, 3.3V Voltage, 5V Voltage, 12V Voltage

The onboard hardware monitor automatically detects the voltage output through the onboard voltage regulators.

2.6 Boot menu

The Boot menu items allow you to change the system boot options. Select an item then press <Enter> to display the sub-menu.



2.6.1 Boot Device Priority

1st ~ xxth Boot Device

These items specify the boot device priority sequence from the available devices. The number of device items that appears on the screen depends on the number of devices installed in the system. Configuration options: [Hard Drive] [Removable Dev.] [ATAPI CD-ROM] [Disabled]

2.6.2 Boot Settings Configuration

Quick Boot [Enabled]

Enabling this item allows the BIOS to skip some power on self tests (POST) while booting to decrease the time needed to boot the system. When set to **[Disabled]**, BIOS performs all the POST items. Configuration options: [Disabled] [Enabled]

Full Screen Logo [Enabled]

This allows you to enable or disable the full screen logo display feature. Configuration options: [Disabled] [Enabled]



Set this item to **[Enabled]** to use the ASUS MyLogo2™ feature.

AddOn ROM Display Mode [Force BIOS]

Sets the display mode for option ROM. Configuration options: [Force BIOS] [Keep Current]

Bootup Num-Lock [On]

Allows you to select the power-on state for the NumLock. Configuration options: [Off] [On]

PS/2 Mouse Support [Auto]

Allows you to enable or disable support for PS/2 mouse. Configuration options: [Disabled] [Enabled] [Auto]

Wait For 'F1' If Error [Enabled]

When set to **Enabled**, the system waits for the F1 key to be pressed when error occurs.
Configuration options: [Disabled] [Enabled]

Hit 'DEL' Message Display [Enabled]

When set to **[Enabled]**, the system displays the message **Press DEL to run Setup** during POST. Configuration options: [Disabled] [Enabled]

Interrupt 19 Capture [Disabled]

When set to **[Enabled]**, this function allows the option ROMs to trap Interrupt 19.
Configuration options: [Disabled] [Enabled]

2.6.3 Security

The **Security** menu items allow you to change the system security settings. Select an item then press **<Enter>** to display the configuration options.

Change Supervisor Password

Select this item to set or change the supervisor password. The **Supervisor Password** item on top of the screen shows the default **Not Installed**. After you set a password, this item shows **Installed**.

To set a Supervisor Password:

1. Select the **Change Supervisor Password** item and press **<Enter>**.
2. From the password box, type a password composed of at least six letters or numbers, then press **<Enter>**.
3. Confirm the password when prompted.

The message **Password Installed** appears after you successfully set your password.

To change the supervisor password, follow the same steps in setting a supervisor password.

To clear the supervisor password, select the **Change Supervisor Password** then press **<Enter>**. The message **Password uninstalled** appears.



If you forget your BIOS password, you can clear it by erasing the CMOS Real Time Clock (RTC) RAM. See section **1.9 Jumpers** for information on how to erase the RTC RAM.

After you have set a supervisor password, the other items appear to allow you to change other security settings.

User Access Level [Full Access]

This item allows you to select the access restriction to the Setup items.

Configuration options: [No Access] [View Only] [Limited] [Full Access]

[No Access] - prevents user access to the Setup utility.

[View Only] - allows access but does not allow change to any field.

[Limited] - allows changes only to selected fields, such as Date and Time.

[Full Access] - allows viewing and changing all the fields in the Setup utility.

Change User Password

Select this item to set or change the user password. The **User Password** item on top of the screen shows the default **Not Installed**. After you set a password, this item shows **Installed**. To set a User Password:

1. Select the **Change User Password** item and press **<Enter>**.
2. From the password box, type a password composed of at least six letters and/or numbers, then press **<Enter>**.
3. Confirm the password when prompted.

The message **Password Installed** appears after you set your password successfully. To change the user password, follow the same steps in setting a user password.

Clear User Password

Select this item to clear the user password.

Password Check [Setup]

When set to **[Setup]**, BIOS checks for user password when accessing the Setup utility. When set to **[Always]**, BIOS checks for user password both when accessing Setup and booting the system. Configuration options: [Setup] [Always]

2.7 Tools menu

The Tools menu items allow you to configure options for special functions. Select an item then press **<Enter>** to display the sub-menu.



2.7.1 ASUS EZ Flash 2

Allows you to run ASUS EZ Flash 2. When you press **<Enter>**, a confirmation message appears. Use the left/right arrow key to select between **[Yes]** or **[No]**, then press **<Enter>** to confirm your choice. Please see section 2.1.3 for details.

2.7.2 AI NET 2

Check Realtek LAN cable [Disabled]

Enables or disables checking of the Realtek LAN cable during the Power-On Self-Test (POST). Configuration options: [Disabled] [Enabled]

2.8 Exit menu

The Exit menu items allow you to load the optimal or failsafe default values for the BIOS items, and save or discard your changes to the BIOS items.

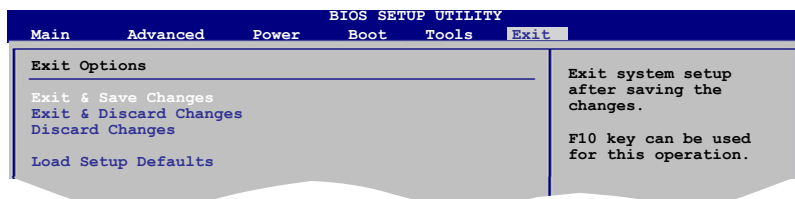

Pressing **<Esc>** does not immediately exit this menu. Select one of the options from this menu or **<F10>** from the legend bar to exit.

Exit & Save Changes

Once you are finished making your selections, choose this option from the Exit menu to ensure the values you selected are saved to the CMOS RAM. An onboard backup battery sustains the CMOS RAM so it stays on even when the PC is turned off. When you select this option, a confirmation window appears. Select **OK** to save changes and exit.

Exit & Discard Changes

Select this option only if you do not want to save the changes that you made to the Setup program. If you made changes to fields other than System Date, System Time, and Password, the BIOS asks for a confirmation before exiting.

Discard Changes

This option allows you to discard the selections you made and restore the previously saved values. After selecting this option, a confirmation appears. Select **OK** to discard any changes and load the previously saved values.

Load Setup Defaults

This option allows you to load the default values for each of the parameters on the Setup menu. When you select this option or if you press **<F5>**, a confirmation window appears. Select **OK** to load default values. Select **Exit & Save Changes** or make other changes before saving the values to the non-volatile RAM.