

P5QPL-VM

ASUS[®]

Motherboard

E4130

First Edition
September 2008

Copyright © 2008 ASUSTeK Computer Inc. All Rights Reserved.

No part of this manual, including the products and software described in it, may be reproduced, transmitted, transcribed, stored in a retrieval system, or translated into any language in any form or by any means, except documentation kept by the purchaser for backup purposes, without the express written permission of ASUSTeK Computer Inc. ("ASUS").

Product warranty or service will not be extended if: (1) the product is repaired, modified or altered, unless such repair, modification or alteration is authorized in writing by ASUS; or (2) the serial number of the product is defaced or missing.

ASUS PROVIDES THIS MANUAL "AS IS" WITHOUT WARRANTY OF ANY KIND, EITHER EXPRESS OR IMPLIED, INCLUDING BUT NOT LIMITED TO THE IMPLIED WARRANTIES OR CONDITIONS OF MERCHANTABILITY OR FITNESS FOR A PARTICULAR PURPOSE. IN NO EVENT SHALL ASUS, ITS DIRECTORS, OFFICERS, EMPLOYEES OR AGENTS BE LIABLE FOR ANY INDIRECT, SPECIAL, INCIDENTAL, OR CONSEQUENTIAL DAMAGES (INCLUDING DAMAGES FOR LOSS OF PROFITS, LOSS OF BUSINESS, LOSS OF USE OR DATA, INTERRUPTION OF BUSINESS AND THE LIKE), EVEN IF ASUS HAS BEEN ADVISED OF THE POSSIBILITY OF SUCH DAMAGES ARISING FROM ANY DEFECT OR ERROR IN THIS MANUAL OR PRODUCT.

SPECIFICATIONS AND INFORMATION CONTAINED IN THIS MANUAL ARE FURNISHED FOR INFORMATIONAL USE ONLY, AND ARE SUBJECT TO CHANGE AT ANY TIME WITHOUT NOTICE, AND SHOULD NOT BE CONSTRUED AS A COMMITMENT BY ASUS. ASUS ASSUMES NO RESPONSIBILITY OR LIABILITY FOR ANY ERRORS OR INACCURACIES THAT MAY APPEAR IN THIS MANUAL, INCLUDING THE PRODUCTS AND SOFTWARE DESCRIBED IN IT.

Products and corporate names appearing in this manual may or may not be registered trademarks or copyrights of their respective companies, and are used only for identification or explanation and to the owners' benefit, without intent to infringe.

Contents

Notices.....	vi
Safety information	vii
About this guide	viii
P5QPL-VM specifications summary	x

Chapter 1: Product introduction

1.1	Welcome!	1-2
1.2	Package contents.....	1-2
1.3	Special features.....	1-2
1.3.1	Product highlights	1-2
1.3.2	ASUS Special features	1-4
1.3.3	ASUS Overclocking feature	1-5
1.4	Before you proceed	1-6
1.5	Motherboard overview.....	1-7
1.5.1	Placement direction	1-7
1.5.2	Screw holes	1-7
1.5.3	Motherboard layout.....	1-8
1.6	Central Processing Unit (CPU)	1-9
1.6.1	Installing the CPU	1-10
1.6.2	Installing the CPU heatsink and fan.....	1-13
1.6.3	Uninstalling the CPU heatsink and fan	1-14
1.7	System memory	1-15
1.7.1	Overview	1-15
1.7.2	Memory configurations.....	1-16
1.7.3	Installing a DIMM	1-21
1.7.4	Removing a DIMM	1-21
1.8	Expansion slots.....	1-22
1.8.1	Installing an expansion card	1-22
1.8.2	Configuring an expansion card	1-22
1.8.3	Interrupt assignments	1-23
1.8.4	PCI slots.....	1-24
1.8.5	PCI Express x1 slot.....	1-24
1.8.6	PCI Express x16 slot.....	1-24
1.9	Jumper	1-25
1.10	Connectors	1-26

Contents

1.10.1	Rear panel connectors	1-26
1.10.2	Internal connectors	1-28
Chapter 2: BIOS setup		
2.1	Managing and updating your BIOS	2-2
2.1.1	ASUS Update utility	2-2
2.1.2	Creating a bootable floppy disk	2-5
2.1.3	ASUS EZ Flash 2 utility	2-6
2.1.4	AFUDOS utility	2-7
2.1.5	ASUS CrashFree BIOS 3 utility	2-9
2.2	BIOS setup program	2-11
2.2.1	BIOS menu screen	2-12
2.2.2	Menu bar	2-12
2.2.3	Navigation keys	2-12
2.2.4	Menu items	2-13
2.2.5	Sub-menu items	2-13
2.2.6	Configuration fields	2-13
2.2.7	Pop-up window	2-13
2.2.8	Scroll bar	2-13
2.2.9	General help	2-13
2.3	Main menu	2-14
2.3.1	System Time	2-14
2.3.2	System Date	2-14
2.3.3	Legacy Diskette A	2-14
2.3.4	Primary IDE Master/Slave, SATA1~4	2-15
2.3.5	Storage Configuration	2-16
2.3.6	System Information	2-17
2.4	Advanced menu	2-18
2.4.1	JumperFree Configuration	2-18
2.4.2	CPU Configuration	2-21
2.4.3	Chipset	2-22
2.4.4	Onboard Devices Configuration	2-25
2.4.5	USB Configuration	2-26
2.4.6	PCI PnP	2-27

Contents

2.5	Power menu	2-28
2.5.1	Suspend Mode	2-28
2.5.2	ACPI 2.0 Support	2-28
2.5.3	ACPI APIC Support	2-28
2.5.4	APM Configuration.....	2-29
2.5.5	Hardware Monitor	2-30
2.6	Boot menu	2-31
2.6.1	Boot Device Priority	2-31
2.6.2	Boot Settings Configuration	2-32
2.6.3	Security	2-33
2.7	Tools menu	2-35
2.7.1	ASUS EZ Flash 2.....	2-35
2.7.2	Express Gate	2-36
2.7.3	AI NET 2.....	2-36
2.8	Exit menu	2-37
 Chapter 3: Software support		
3.1	Installing an operating system	3-2
3.2	Support DVD information	3-2
3.2.1	Running the support DVD	3-2
3.2.2	Drivers menu	3-3
3.2.3	Utilities menu	3-4
3.2.4	Manual menu	3-6
3.2.5	ASUS Contact information	3-6
3.3	Software information	3-7
	ASUS Express Gate.....	3-7

Notices

Federal Communications Commission Statement

This device complies with Part 15 of the FCC Rules. Operation is subject to the following two conditions:

- This device may not cause harmful interference, and
- This device must accept any interference received including interference that may cause undesired operation.

This equipment has been tested and found to comply with the limits for a Class B digital device, pursuant to Part 15 of the FCC Rules. These limits are designed to provide reasonable protection against harmful interference in a residential installation. This equipment generates, uses and can radiate radio frequency energy and, if not installed and used in accordance with manufacturer's instructions, may cause harmful interference to radio communications. However, there is no guarantee that interference will not occur in a particular installation. If this equipment does cause harmful interference to radio or television reception, which can be determined by turning the equipment off and on, the user is encouraged to try to correct the interference by one or more of the following measures:

- Reorient or relocate the receiving antenna.
- Increase the separation between the equipment and receiver.
- Connect the equipment to an outlet on a circuit different from that to which the receiver is connected.
- Consult the dealer or an experienced radio/TV technician for help.



The use of shielded cables for connection of the monitor to the graphics card is required to assure compliance with FCC regulations. Changes or modifications to this unit not expressly approved by the party responsible for compliance could void the user's authority to operate this equipment.

Canadian Department of Communications Statement

This digital apparatus does not exceed the Class B limits for radio noise emissions from digital apparatus set out in the Radio Interference Regulations of the Canadian Department of Communications.

This class B digital apparatus complies with Canadian ICES-003.

Safety information

Electrical safety

- To prevent electrical shock hazard, disconnect the power cable from the electrical outlet before relocating the system.
- When adding or removing devices to or from the system, ensure that the power cables for the devices are unplugged before the signal cables are connected. If possible, disconnect all power cables from the existing system before you add a device.
- Before connecting or removing signal cables from the motherboard, ensure that all power cables are unplugged.
- Seek professional assistance before using an adapter or extension cord. These devices could interrupt the grounding circuit.
- Ensure that your power supply is set to the correct voltage in your area. If you are not sure about the voltage of the electrical outlet you are using, contact your local power company.
- If the power supply is broken, do not try to fix it by yourself. Contact a qualified service technician or your retailer.

Operation safety

- Before installing the motherboard and adding devices on it, carefully read all the manuals that came with the package.
- Before using the product, ensure that all cables are correctly connected and the power cables are not damaged. If you detect any damage, contact your dealer immediately.
- To avoid short circuits, keep paper clips, screws, and staples away from connectors, slots, sockets and circuitry.
- Avoid dust, humidity, and temperature extremes. Do not place the product in any area where it may become wet.
- Place the product on a stable surface.
- If you encounter technical problems with the product, contact a qualified service technician or your retailer.



This symbol of the crossed out wheeled bin indicates that the product (electrical and electronic equipment, Mercury-containing button cell battery) should not be placed in municipal waste. Check local regulations for disposal of electronic products.

About this guide

This user guide contains the information you need when installing and configuring the motherboard.

How this guide is organized

This manual contains the following parts:

- **Chapter 1: Product introduction**
This chapter describes the features of the motherboard and the new technology it supports. It also lists the hardware setup procedures that you have to perform when installing system components. It includes description of the jumpers and connectors on the motherboard.
- **Chapter 2: BIOS setup**
This chapter tells how to change system settings through the BIOS Setup menus. Detailed descriptions of the BIOS parameters are also provided.
- **Chapter 3: Software support**
This chapter describes the contents of the support DVD that comes with the motherboard package.

Where to find more information

Refer to the following sources for additional information and for product and software updates.

1. **ASUS websites**
The ASUS website provides updated information on ASUS hardware and software products. Refer to the ASUS contact information.
2. **Optional documentation**
Your product package may include optional documentation, such as warranty flyers, that may have been added by your dealer. These documents are not part of the standard package.

Conventions used in this guide

To ensure that you perform certain tasks properly, take note of the following symbols used throughout this manual.



DANGER/WARNING: Information to prevent injury to yourself when trying to complete a task.



CAUTION: Information to prevent damage to the components when trying to complete a task.



IMPORTANT: Instructions that you **MUST** follow to complete a task.



NOTE: Tips and additional information to help you complete a task.

Typography

Bold text

Indicates a menu or an item to select.

Italics

Used to emphasize a word or a phrase.

<Key>

Keys enclosed in the less-than and greater-than sign means that you must press the enclosed key.

Example: <Enter> means that you must press the Enter or Return key.

<Key1>+<Key2>+<Key3>

If you must press two or more keys simultaneously, the key names are connected with a plus sign (+).

Example: <Ctrl>+<Alt>+<D>

Command

Means that you must type the command exactly as shown.

Example: At the DOS prompt, type the command line:

```
afudos /i [filename]
```

```
afudos /iP5QPL-VM.ROM
```

P5QPL-VM specifications summary

CPU	<p>LGA775 socket for Intel® Core™2 Quad/Core™2 Extreme/Core™2 Duo/Pentium® dual-core/Celeron® dual-core/Celeron® Processors</p> <p>Compatible with Intel® 05B/05A/06 processors</p> <p>Supports 45nm multi-core CPU</p> <p>(Refer to www.asus.com for Intel CPU support list)</p>
Chipset	<p>Northbridge: Intel® G41</p> <p>Southbridge: Intel® ICH7</p>
Front Side Bus	1333/1066/800 MHz
Memory	<p>Dual channel memory architecture</p> <p>4 x 240-pin DIMM sockets supports unbuffered non-ECC 8GB 1066(overclocking)/800/667 MHz DDR2 memory modules</p> <ul style="list-style-type: none"> • When installing total memory of 4GB capacity or more, Windows® 32-bit operation system may only recognize less than 3GB. Hence, a total installed memory of less than 3GB is recommended. • Refer to www.asus.com or this user manual for the Memory QVL (Qualified Vendors Lists).
Graphics	<p>Intel® Graphics Media Accelerator (Intel® GMA 4500) integrated</p> <p>Multi-VGA output support DisplayPort & RGB, or DVI & RGB</p> <p>Supports DVI with max. resolution of 1900 x 1200 @ 60Hz (1080P)</p> <p>Supports RGB with max. resolution of 2048 x 1536 @ 75Hz</p> <p>Supports DisplayPort with max. resolution of 2560 x 1600 @ 60Hz</p> <p>Maximum shared memory of 1849MB</p>
Expansion Slots	<p>Supports PCIe 1.1 Architecture</p> <p>1 x PCI Express x16 slot</p> <p>1 x PCI Express x1 slot</p> <p>2 x PCI slots</p>
Storage	<p>Southbridge Intel® ICH7 supports:</p> <ul style="list-style-type: none"> - 1 x Ultra DMA 100/66 hard disk drive - 4 x Serial ATA 300/150 ports
LAN	PCIe Gigabit LAN
Audio	<p>8-channel High Definition Audio CODEC</p> <p>Supports Jack-detect and Multi-Streaming technologies</p> <p>Supports S/PDIF out interface</p>
ASUS Overclocking Features	<p>SFS (Stepless Frequency Selection):</p> <ul style="list-style-type: none"> - FSB tuning from 200 MHz up to 400 MHz at 1MHz increment <p>Overclocking Protection:</p> <ul style="list-style-type: none"> - ASUS C.P.R. (CPU Parameter Recall)

(continued on the next page)

P5QPL-VM specifications summary

ASUS Special Features	<p>ASUS CrashFree BIOS 3 ASUS Q-Fan ASUS EZ Flash 2 ASUS MyLogo 2 AI NET 2 Express Gate*</p> <p>*The actual boot time depends on the hardware configuration and product model.</p>
Back Panel I/O Ports	<p>1 x PS/2 keyboard port 1 x PS/2 mouse port 1 x DVI port 1 x DisplayPort 1 x optical S/PDIF out port 1 x VGA port 1 x RJ-45 port 4 x USB 2.0/1.1 ports 8-channel audio I/O ports</p>
Internal I/O Connectors	<p>2 x USB 2.0 connectors supports additional 4 USB 2.0 ports 1 x Floppy disk drive connector 1 x IDE connector 1 x COM connector 4 x Serial ATA connectors 1 x CPU fan connector 1 x Chassis fan connector 1 x Power fan connector 1 x S/PDIF Out connector 1 x LPT connector 1 x Chassis intrusion connector 1 x High definition front panel audio connector 1 x CD audio in connector 1 x 24-pin EPS 12 V power connector 1 x 4-pin ATX 12 V power connector 1 x System panel connector</p>
USB	<p>Max. 8 x USB 2.0/1.1 ports (4 ports at mid-board, 4 ports at back panel)</p>
BIOS features	<p>8 Mb Flash ROM, AMI BIOS, PnP, DMI v2.0, WfM2.0, SM BIOS v2.5</p>
Support DVD Contents	<p>Drivers ASUS PC Probe II ASUS LiveUpdate Utility Anti-virus software (OEM version)</p>

(continued on the next page)

P5QPL-VM specifications summary

Accessories	1 x Serial ATA cable 1 x Serial ATA power cable 1 x Ultra DMA 133/100/66 cable 1 x I/O shield User guide
Form factor	MicroATX form factor: 9.6 in x 9.6 in (24.4 cm x 24.4 cm)

*Specifications are subject to change without notice.

This chapter describes the motherboard features and the new technologies it supports.

1 Product introduction

1.1 Welcome!

Thank you for buying an ASUS® P5QPL-VM motherboard!

The motherboard delivers a host of new features and latest technologies, making it another standout in the long line of ASUS quality motherboards!

Before you start installing the motherboard, and hardware devices on it, check the items in your package with the list below.

1.2 Package contents

Check your motherboard package for the following items.

Motherboard	ASUS P5QPL-VM
Cables	1 x Ultra DMA 133/100/66 cable 1 x SATA cable 1 x SATA power cable
Accessories	I/O shield
Application DVD	ASUS motherboard support DVD
Documentation	User guide



If any of the above items is damaged or missing, contact your retailer.

1.3 Special features

1.3.1 Product highlights

Green ASUS



This motherboard and its packaging comply with the European Union's Restriction on the use of Hazardous Substances (RoHS). This is in line with the ASUS vision of creating environment-friendly and recyclable products/packaging to safeguard consumers' health while minimizing the impact on the environment.

Intel® Core™2 Processor Ready



This motherboard supports the latest Intel® Core™2 processor in the LGA775 package. It also supports Intel® 45nm Multi-Core CPU. With the new Intel® Core™2 microarchitecture technology and 1333/1066/800 MHz FSB, Intel® Core™2 processor is designed to provide powerful and energy efficient performance.

Intel® G41 Chipset



The Intel® G41 Express Chipset is the latest chipset designed to support dual-channel DDR2 1066(overclocking)/800/667 architecture, 1333/1066/800 Front Side Bus (FSB), PCIe 1.1, and multi-core CPUs. It provides digital home entertainment of full 1080p high-definition video playback, including Blu-ray disc movies, with the next-generation Intel® Graphics Media Accelerator X4500. The Intel® G41 Express Chipset delivers optimized 3D graphics performance and support for Microsoft DirectX10. Shader Model 4.0 and OpenGL 2.1. It especially includes Intel® Fast Memory Access technology the significantly optimized the use of available memory bandwidth and reduces the latency of the memory accesses.

High Definition Audio



Enjoy high-end sound quality on your PC! The onboard 8-channel HD audio (High Definition Audio, previously codenamed Azalia) CODEC enables high-quality 192KHz/24-bit audio output, jack-detect feature.

Gigabit LAN solution



PCI Express Gb LAN controller delivers transfer speeds up to ten times faster than conventional 10/100/1000 Ethernet connections. Gigabit LAN is the networking standard for the early future and is ideal for handling large amounts of data such as video, audio, and voice. See page 1-26 for details.

DVI Interface



DVI (Digital Visual Interface) provides high visual quality of digital display devices such as LCD monitor. The interface of this motherboard is HDCP compliant, allowing playback of HD DVD, Blu-ray Disc and other protected content.

DisplayPort



This motherboard introduces the new digital display interface standard - DisplayPort. This new design features a small and user-friendly connector. It delivers higher performances of resolution, refresh rate, and color depth and improves digital display connectivity. See page 1-27 for details.



Due to chipset limitation, DisplayPort on this motherboard only supports video signals.

1.3.2 ASUS Special features

ASUS Q-Fan technology



The ASUS Q-Fan technology smartly adjusts the fan speeds according to the system loading to ensure quiet, cool, and efficient operation. See page 2-30 for details.

ASUS MyLogo2™



This feature allows you to convert your favorite photo into a 256-color boot logo for a more colorful and vivid image on your screen. See page 2-32 for details.

ASUS EZ Flash 2



EZ Flash 2 is a user-friendly BIOS update utility. Simply press the predefined hotkey to launch the utility and update the BIOS without entering the OS. Update your BIOS easily without preparing a bootable diskette or using an OS-based flash utility. See page 2-6 for details.

ASUS CrashFree BIOS 3



The ASUS CrashFree BIOS 3 allows users to restore corrupted BIOS data from a USB flash disk containing the BIOS file. See page 2-9 for details.

Express Gate



Taking only 5 seconds to go online from bootup, Express Gate is the one-stop gateway to instant fun! It's a unique motherboard built-in OS. You can utilize the most popular Instant Messengers (IM) like MSN, Skype, Google talk, QQ, and Yahoo! Messenger to keep in touch with friends, or quickly check on the weather and e-mails just before leaving your house. What's more, the user-friendly picture manager lets you view your pictures without entering Windows at anytime! See pages 2-36, and 3-7 to 3-15 for details.



- The actual boot time depends on the system configuration, hardware configurations, and product model.
- ASUS Express Gate supports file uploading from SATA HDDs, ODDs and USB drive and downloading to USB drives only.



AI NET 2

AI NET 2 is a BIOS-based diagnostic tool that detects and reports Ethernet cable faults and shorts. With this utility, you can easily monitor the condition of the Ethernet cable(s) connected to the Marvell® LAN (RJ-45) port. During the bootup process, AI NET 2 immediately diagnoses the LAN cable and reports shorts and faults up to 100 meters at 1 meter accuracy. See page 2-36 for details.

1.3.3 ASUS Overclocking feature

C.P.R. (CPU Parameter Recall)

The C.P.R. feature of the motherboard BIOS allows automatic re-setting to the BIOS default settings in case the system hangs due to overclocking. When the system hangs due to overclocking, C.P.R. eliminates the need to open the system chassis and clear the RTC data. Simply shut down the system, and the BIOS automatically restores the CPU default setting for each parameter.

1.4 Before you proceed

Take note of the following precautions before you install motherboard components or change any motherboard settings.



- Unplug the power cord from the wall socket before touching any component.
- Use a grounded wrist strap or touch a safely grounded object or a metal object, such as the power supply case, before handling components to avoid damaging them due to static electricity.
- Hold components by the edges to avoid touching the ICs on them.
- Whenever you uninstall any component, place it on a grounded antistatic pad or in the bag that came with the component.
- Before you install or remove any component, ensure that the ATX power supply is switched off or the power cord is detached from the power supply. Failure to do so may cause severe damage to the motherboard, peripherals, and/or components.

Onboard LED

The motherboard comes with a standby power LED that lights up to indicate that the system is ON, in sleep mode, or in soft-off mode. This is a reminder that you should shut down the system and unplug the power cable before removing or plugging in any motherboard component. The illustration below shows the location of the onboard LED.

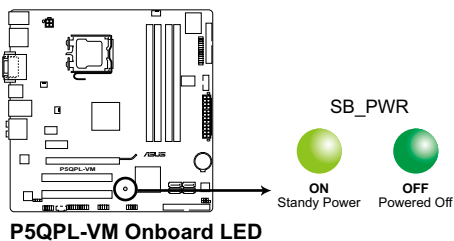

1.5 Motherboard overview

Before you install the motherboard, study the configuration of your chassis to ensure that the motherboard fits into it.



Ensure to unplug the power cord before installing or removing the motherboard. Failure to do so can cause you physical injury and damage motherboard components.

1.5.1 Placement direction

When installing the motherboard, ensure that you place it into the chassis in the correct orientation. The edge with external ports goes to the rear part of the chassis as indicated in the image below.

1.5.2 Screw holes

Place eight (8) screws into the holes indicated by circles to secure the motherboard to the chassis.



DO NOT overtighten the screws! Doing so can damage the motherboard.

Place this side towards
the rear of the chassis

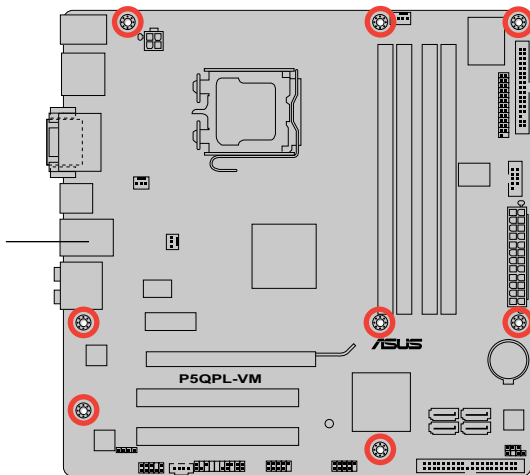

1.5.3 Motherboard layout

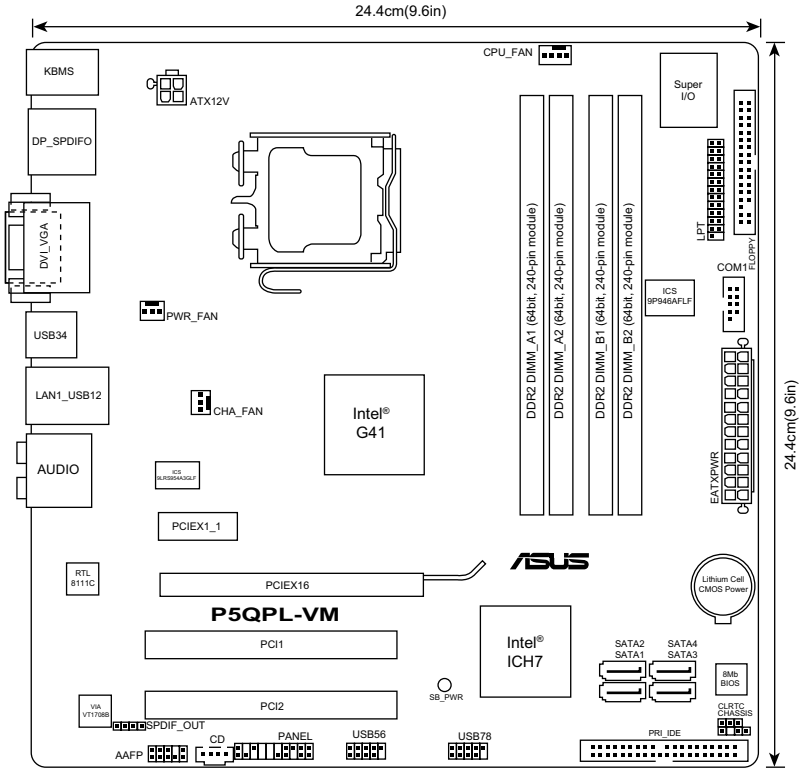

Refer to section 1.10 Connectors for more information about rear panel connectors and internal connectors.

1.6 Central Processing Unit (CPU)

The motherboard comes with a surface mount LGA775 socket designed for the Intel® Core™2 Quad/Core™2 Extreme/Core™2 Duo/Pentium® dual-core/Celeron® dual-core/Celeron® Processors.



-
- Ensure that the AC power is off before you install the CPU.
 - If installing a dual-core CPU, connect the chassis fan cable to the chassis fan connector to ensure system stability.
-



-
- Upon purchase of the motherboard, ensure that the PnP cap is on the socket and the socket contacts are not bent. Contact your retailer immediately if the PnP cap is missing, or if you see any damage to the PnP cap/socket contacts/motherboard components. ASUS will shoulder the cost of repair only if the damage is shipment/transit-related.
 - Keep the cap after installing the motherboard. ASUS will process Return Merchandise Authorization (RMA) requests only if the motherboard comes with the cap on the LGA775 socket.
 - The product warranty does not cover damage to the socket contacts resulting from incorrect CPU installation/removal, or misplacement/loss/incorrect removal of the PnP cap.
-

1.6.1 Installing the CPU

To install a CPU:

1. Locate the CPU socket on the motherboard.

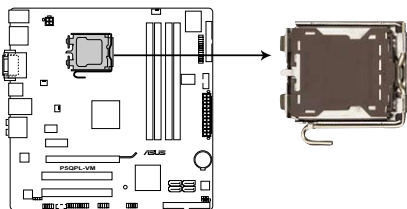

P5QPL-VM CPU socket 775



Before installing the CPU, ensure that the socket box is facing towards you and the load lever is on your left.

2. Press the load lever with your thumb (A), then move it to the left (B) until it is released from the retention tab.



To prevent damage to the socket pins, do not remove the PnP cap unless you are installing a CPU.

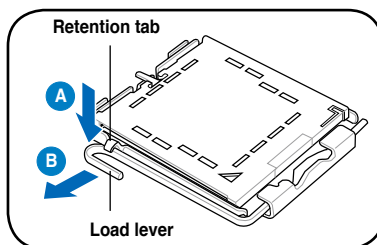

3. Lift the load lever in the direction of the arrow to a 135° angle.

4. Lift the load plate with your thumb and forefinger to a 100° angle (4A), then push the PnP cap from the load plate window to remove (4B).

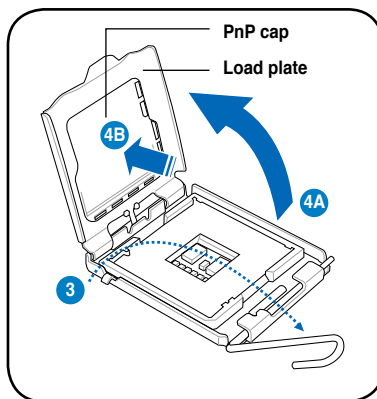

5. Position the CPU over the socket, ensuring that the gold triangle is on the bottom-left corner of the socket then fit the socket alignment key into the CPU notch.



The CPU fits in only one correct orientation. **DO NOT** force the CPU into the socket to prevent bending the connectors on the socket and damaging the CPU!

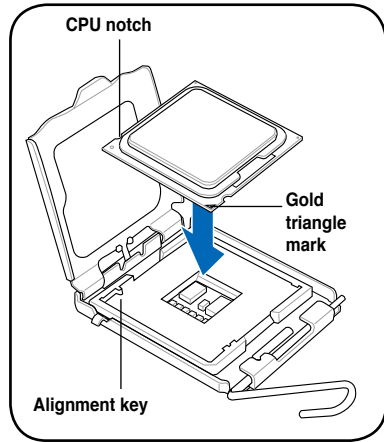

6. Apply several drops of Thermal Interface Material to the exposed area of the CPU that the heatsink will be in contact with, ensuring that it is spread in an even thin layer.



Some heatsinks come with pre-applied thermal paste. If so, skip this step.

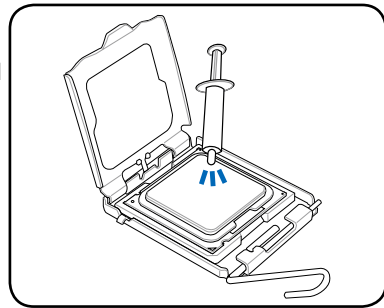

DO NOT eat the Thermal Interface Material. If it gets into your eyes or touches your skin, ensure that you wash it off immediately, and seek professional medical help.



To prevent contaminating the paste, **DO NOT** spread the paste with your finger directly.

7. Close the load plate (A), then push the load lever (B) until it snaps into the retention tab.

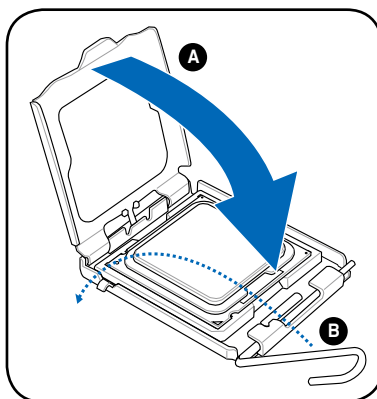

1.6.2 Installing the CPU heatsink and fan

The Intel® LGA775 processor requires a specially designed heatsink and fan assembly to ensure optimum thermal condition and performance.



- When you buy a boxed Intel® processor, the package includes the CPU fan and heatsink assembly. If you buy a CPU separately, ensure that you use only Intel®-certified multi-directional heatsink and fan.
- Your Intel® LGA775 heatsink and fan assembly comes in a push-pin design and requires no tool to install.
- If you purchased a separate CPU heatsink and fan assembly, ensure that you have properly applied Thermal Interface Material to the CPU heatsink or CPU before you install the heatsink and fan assembly.



Ensure that you have installed the motherboard to the chassis before you install the CPU fan and heatsink assembly.



If you purchased a separate CPU heatsink and fan assembly, ensure that that Thermal Interface Material is properly applied to the CPU heatsink or CPU before you install the heatsink and fan assembly.

To install the CPU heatsink and fan:

1. Place the heatsink on top of the installed CPU, ensuring that the four fasteners match the holes on the motherboard.
2. Push down two fasteners at a time in a diagonal sequence to secure the heatsink and fan assembly in place.

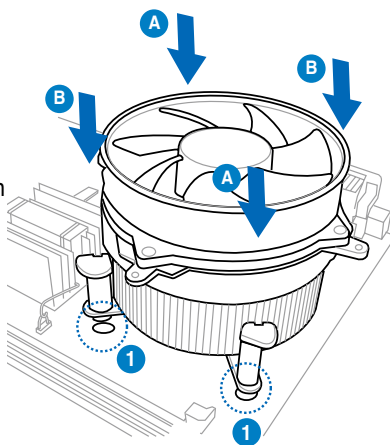
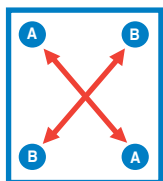

The type of CPU heatsink and fan assembly may differ, but the installation steps and functions should remain the same. The illustration above is for reference only.

3. Connect the CPU fan cable to the connector on the motherboard labeled CPU_FAN.

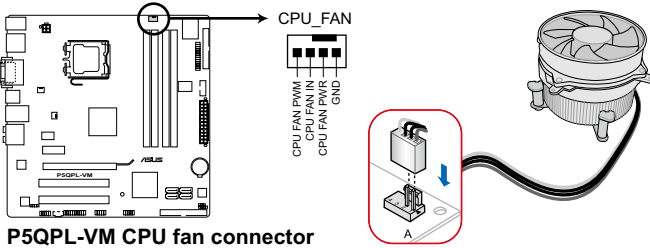

DO NOT forget to connect the CPU fan connector! Hardware monitoring errors can occur if you fail to plug this connector.

1.6.3 Uninstalling the CPU heatsink and fan

To uninstall the CPU heatsink and fan

1. Disconnect the CPU fan cable from the connector on the motherboard.
2. Rotate each fastener counterclockwise.
3. Pull up two fasteners at a time in a diagonal sequence to disengage the heatsink and fan assembly from the motherboard.

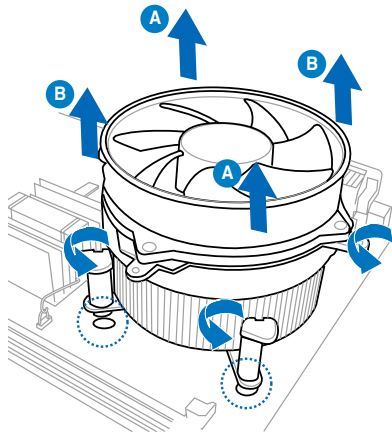
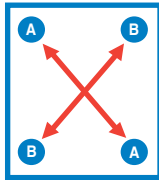

4. Carefully remove the heatsink and fan assembly from the motherboard.

1.7 System memory

1.7.1 Overview

The motherboard comes with two Double Data Rate 2 (DDR2) Dual Inline Memory Modules (DIMM) sockets.

A DDR2 module has the same physical dimensions as a DDR DIMM but has a 240-pin footprint compared to the 184-pin DDR DIMM. DDR2 DIMMs are notched differently to prevent installation on a DDR DIMM socket.

The figure illustrates the location of the DDR2 DIMM sockets:

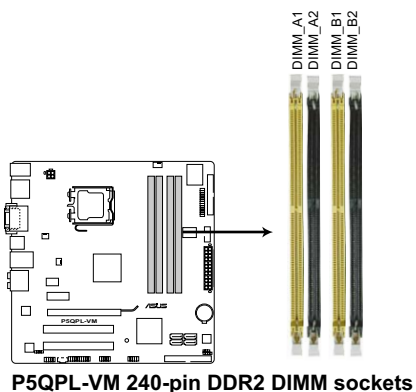

Channel	Sockets
Channel A	DIMM_A1 and DIMM_A2
Channel B	DIMM_B1 and DIMM_B2

1.7.2 Memory configurations

You may install 256 MB, 512 MB, 1 GB and 2 GB unbuffered non-ECC DDR2 DIMMs into the DIMM sockets.



- You may install varying memory sizes in Channel A and Channel B. The system maps the total size of the lower-sized channel for the dual-channel configuration. Any excess memory from the higher-sized channel is then mapped for single-channel operation.
- Always install DIMMs with the same CAS latency. For optimum compatibility, it is recommended that you obtain memory modules from the same vendor.
- For single-channel configuration, you may:
 - install one double-sided DIMM in any of the four sockets OR
 - install two single-sided DIMMs in DIMM_A1 and DIMM_A2, or in DIMM_B1 and DIMM_B2.
- For dual-channel configuration, you may:
 - install two double-sided DIMMs OR
 - install four single-sided DIMMs.
- Only DIMM_A1 and DIMM_B1 support 1066 memory modules.
- When installing total memory of 4GB capacity or more, Windows® 32-bit operation system may only recognize less than 3GB. Hence, a total installed memory of less than 3GB is recommended.
- This motherboard does not support memory modules made up of 128 or 256 chips.



- Due to chipset limitation, this motherboard can only support up to 4 GB on the operating systems listed below. You may install a maximum of 1 GB DIMMs on each slot, but only DDR2-800 and DDR2-667 1 GB density modules are available for this configuration.

32-bit	64-bit
Windows® XP	Windows® XP x64 Edition
Windows® Vista	Windows® Vista x64 Edition

- Some old-version DDR2-800 DIMMs may not match Intel® On-Die-Termination (ODT) requirement and will automatically downgrade to run at DDR-667. If this happens, contact your memory vendor to check to ODT value.

Qualified Vendors Lists (QVL)

DDR2 667

Size	Vendor	Part No.	CL	Chip Brand	SS/DS	Chip No.	DIMM support		
							A*	B*	C*
2G	Kingston	KVR667D2N5/2G	N/A	Micron	DS	7RE22 D9HNL		*	*
512MB	Kingston	KVR667D2N5/512	N/A	Kingston	SS	SO1237650821 SBP D6408TR4CG L25ULS074905PECNB		*	*
2G	Kingston	KVR667D2N5/2G	N/A	Elpida	DS	E1108ACBG-8E-E 0813A90CC		*	*
1G	Kingston	KVR667D2N5/1G	N/A	Kingston	DS	SO1280420822 SOP D6408TR4CG L25ULS156304PECCA		*	*
512MB	Qimonda	HYS64T64000EU-3S-B2	5	Qimonda	SS	HYB18T512B00B2F3SFSS28171	*	*	*
1G	Qimonda	HYS64T128020EU-3S-B2	5	Qimonda	DS	HYB18T512B00B2F3SFSS28171	*	*	*
1G	Corsair	VS1GB667D2	N/A	Corsair	DS	MID095D62864M8CEC	*	*	*
512MB	Corsair	V5S12MB667D2	N/A	Corsair	DS	MIII0052532M8CEC	*	*	*
1G	Corsair	XMS2-5400	4	Corsair	DS	Heat-Sink Package	*	*	*
1G	HY	HYMP512U64CP8-Y5 AB	5	Hynix	DS	HY5P512521CFP-Y5	*	*	*
512MB	Kingmax	KLCC28F-A8KB5	N/A	Kingmax	SS	KKEA88B4LAUG-29DX	*	*	*
1G	Kingmax	KLCD48F-A8KB5	N/A	Kingmax	DS	KKEA88B4LAUG-29DX	*	*	*
512MB	Apacer	AU512E667C5KBGC	5	Apacer	SS	AM4B5708MJS7E0627B	*	*	*
512MB	Apacer	AU512E667C5KBGC	5	Apacer	SS	AM4B5708QJ57E06332F	*	*	*
512MB	Apacer	78.91G92.9K5	5	Apacer	SS	AM4B5708JQJ57E0751C	*	*	*
1G	Apacer	78.01G90.9K5	5	Apacer	SS	AM4B5808CQJ57E0751C	*	*	*
1G	Apacer	AU01GE667C5KBGC	N/A	Apacer	DS	AM4B5708QJ57E0636B	*	*	*
1G	Apacer	AU01GE667C5KBGC	5	Apacer	DS	AM4B5708MJS7E0627B	*	*	*
2G	Apacer	78.A1G90.9K4	5	Apacer	DS	AM4B5808CQJ57E0749B	*	*	*
1G	Transcend	506010-4894	5	Elpida	DS	E5108AJBG-6E-E	*	*	*
512MB	ADATA	M2OAD5G3H3160Q1C52	N/A	ADATA	SS	AD29608A8A-3EG20813	*	*	*
1G	ADATA	M2OAD5G314170Q1C58	N/A	ADATA	DS	AD29608A8A-3EG80814	*	*	*
2G	ADATA	M2OAD5H3J41701C53	N/A	ADATA	DS	AD20908A8A-3EG 30724	*	*	*
512MB	PSC	AL6E8E63J-6E1	5	PSC	SS	A3R12E3JFF717B9A00	*	*	*
1G	PSC	AL7E8E63J-6E1	5	PSC	DS	A3R12E3JFF717B9A01	*	*	*
1G	PSC	AL7E8F73C-6E1	5	PSC	SS	A3R1GE3CFF734MAA0J	*	*	*
512MB	Nanya	NT512T64U88A1B1Y-3C	N/A	Nanya	SS	NT5TU64M8AE-3C	*	*	*
1G	Nanya	NT1GT64U8H80B1Y-3C	5	Nanya	DS	NT5TU64M8BE-3C72155700CP	*	*	*
1G	GEIL	GX21GB5300SX	3	GEIL	DS	Heat-Sink Package	*	*	*
2G	GEIL	GX22GB5300LX	5	GEIL	DS	Heat-Sink Package	*	*	*
2G	GEIL	GX24GB5300LDC	5	GEIL	DS	Heat-Sink Package	*	*	*
2G(kit of 2)	G.SKILL	F2-5400PHU2-2GBNT	5-5-5-15	G.SKILL	DS	D2 64M8CCF 0815 C7173S	*	*	*
4G(kit of 2)	G.SKILL	F2-5300CL5D-4GBMQ	5-5-5-15	G.SKILL	DS	Heat-Sink Package	*	*	*
1G	Super Talent	T667UB1GV	5	Super Talent	DS	PG 64M8-800 0750	*	*	*
512MB	Twinmos	8D-A3JK5MPETP	5	PSC	SS	A3R12E3GEF633ACA0Y	*	*	*
4G	Samsung	M378T5263AZ3-CE6	N/A	Samsung	DS	K4T2G084QA-HCE6	*	*	*
1G	ELIXIR	M2Y1G64TUBH8A2B-3C	5	ELIXIR	DS	M2TU51280AE-3C717095R28F	*	*	*
1G	ELIXIR	M2Y1G64TUBH80B-3C	5	ELIXIR	DS	N2TU51280BE-3C63909W1CF	*	*	*
1G	Leadmax	LRMP512U64A8-Y5	N/A	Hynix	DS	HY5P512821CFP-Y5 C 702AA	*	*	*
512MB	MDT	DDRII 512 PC667	4	MDT	DS	18D51201D-30726E	*	*	*
512MB	AENEON	AET660UD00-30DB97X	5	AENEON	SS	AET93R300B 0634	*	*	*
1G	AENEON	AET760UD00-30DB97X	5	AENEON	DS	AET93R300B 0639	*	*	*
2G	AENEON	AET860UD00-30DB08X	5	AENEON	DS	AET93F30DB 0730	*	*	*
512MB	TAKEMS	TMS51B264C081-665QI	5	takeMS	SS	MS18T51280-3	*	*	*
512MB	TAKEMS	TMS51B264C081-665AP	5	takeMS	SS	MS18T51280-3S0627D	*	*	*
1G	TAKEMS	TMS1GB264C081-665QI	5	takeMS	DS	MS18T51280-3	*	*	*
1G	TAKEMS	TMS1GB264C081-665AE	5	takeMS	DS	MS18T51280-3SEA07100	*	*	*
512MB	ASINT	SLX264M8-J6E	N/A	ASINT	SS	DDRII6408-6E	*	*	*
1G	ASINT	SLY2128M8-J6E	N/A	ASINT	SS	DDRII1208-6E 8115	*	*	*
512MB	Century	CENTURY 512MB	N/A	Nanya	SS	NT5TU64M8AE-3C	*	*	*
1G	Century	CENTURY 1G	N/A	Hynix	DS	HY5P512821AFP-Y5	*	*	*
1G	Century	CENTURY 1G	N/A	Nanya	DS	NT5TU64M8AE-3C	*	*	*
1G	UMAX	D46701GP3-63BJU	N/A	UMAX	DS	U2S12D30YP-6E	*	*	*
2G	UMAX	D46702GP0-73BCU	5	UMAX	DS	U2S24D30TP-6E	*	*	*
512MB	KINGBOX	512MB 667MHz	N/A	KINGBOX	SS	EPD264082200-4	*	*	*

(continued on the next page)

DDR2 800

Size	Vendor	Part No.	CL	Chip Brand	SS/ DS	Chip No.	DIMM support		
							A*	B*	C*
1G	Kingston	KHX6400D2LL1/G	N/A	Kingston	DS	Heat-Sink Package	.	.	
1G	Kingston	KVR800D2N5/1G	N/A	Promos	DS	V59C1512804QCF25S0061904PECJA	.	.	
512MB	Kingston	KHX6400D2LLK2/1GN	N/A	Kingston	SS	Heat-Sink Package	.	.	.
1G(Kit of 2)	Kingston	KHX6400D2K2/2G	N/A	Kingston	DS	Heat-Sink Package	.	.	
512MB	Kingston	KVR800D2N6/512	N/A	Elpida	SS	E5108AJBG-8E-E	.	.	.
1G	Kingston	KVR800D2N5/1G	N/A	Elpida	DS	E5108AJBG-8E-E	.	.	
1G	Kingston	KVR800D2N6/1G	N/A	Elpida	DS	E5108AJBG-8E-E	.	.	
2G	Kingston	KVR800D2N5/2G	N/A	Elpida	DS	E1108ACBG-8E-E	.	.	
2G	Kingston	KHX6400D2/2G	N/A	Kingston	DS	Heat-Sink Package	.	.	
4G	Kingston	KVR800D2N6/4G	N/A	Elpida	DS	E2108ABSE-8G-E	.	.	
512MB	Kingston	KVR800D2N5/512	N/A	Kingston	SS	E5108AJBG-8E-E 0803A9082	.	.	
512MB	Samsung	M378T6553GZS-CF7	6	Samsung	SS	K4T51083QG-HCF7	.	.	.
1G	Samsung	M378T2863QZS-CF7	6	Samsung	SS	K4T1G084QQ-HCF7	.	.	.
1G	Samsung	M378T2953GZ3-CF7	6	Samsung	DS	K4T51083QG-HCF7	.	.	
2G	Samsung	M37875663QZ3-CF7	6	Samsung	DS	K4T1G084QQ-HCF7	.	.	
4G	Samsung	M378T5263AZ3-CF7	N/A	Samsung	DS	K4T2G084QA-HCF7	.	.	
1G	Qimonda	HY564T128020EU-2.5-B2	6	Qimonda	DS	HYB18T512800B2F25FSS28380	.	.	
1G	Corsair	XMS2-6400	4	Corsair	DS	Heat-Sink Package	.	.	
1G	Corsair	XMS2-6400	5	Corsair	DS	Heat-Sink Package	.	.	
2G(Kit of 2)	Corsair	CM2X2048-6400C5DHX	5	Corsair	DS	Heat-Sink Package	.	.	
1G	Corsair	CM2X1024-6400	N/A	Corsair	DS	Heat-Sink Package	.	.	
2G(Kit of 2)	Corsair	CM2X2048-6400C5	5	Corsair	DS	Heat-Sink Package	.	.	
2G(Kit of 2)(EPP)	Crucial	BL12864AL804.8FE5	4	N/A	SS	Heat-Sink Package	.	.	
512MB	HY	HYMP564U64CP8-S5 AB	5	Hynix	SS	HY5PS12821CFP-S5	.	.	.
1G	HY	HYMP512U64CP8-S5 AB	5	Hynix	DS	HY5PS12821CFP-S5	.	.	
512MB	Kingmax	KLDC28F-A8K15	N/A	Kingmax	SS	KA8FF1XF-JFS-25A	.	.	.
2G	Kingmax	GE24GB800C5DC	N/A	Kingmax	DS	KA8FF1XF-HFS-25U	.	.	
512MB	Apacer	78.91G91.9K5	5	Apacer	SS	AM4B5708JQS8E0751C	.	.	.
1G	Apacer	78.01GA0.9K5	5	Apacer	SS	AM4B5808CQS8E0749D	.	.	
2G	Apacer	78.A1GA0.9K4	5	Apacer	DS	AM4B5808CQS8E0740E	.	.	
2G	Apacer	78.A1GA0.9K4	5	Apacer	DS	AM4B5808CQS8E0747D	.	.	
1G	Transcend	505649-1993	5	Mircon	DS	7HD22D9GMH	.	.	
512MB	Transcend	TS64MLQ64V8J512MB	5	Micron	SS	7HD22 D9GMH	.	.	.
1G	Transcend	503499-7280	N/A	Micron	DS	7NB32 D9DCL	.	.	
1G	Transcend	TS128MLQ64V8J	5	Transcend	DS	TQ123PJF8F0801	.	.	
512MB	ADATA	M20AD6G3H3160Q1E58	N/A	ADATA	SS	AD29608A8A-25EG80812	.	.	.
1G	ADATA	M20AD6G314170Q1E58	N/A	ADATA	DS	AD29608A8A-25EG80810	.	.	
1G	VDATA	M2GV6DG314170Q1E58	N/A	VDATA	DS	VD29608A8A-25EG80813	.	.	
1G	PSC	AL7E8F73C-8E1	5	PSC	SS	A3R1GE3CFF734MAA0E	.	.	.
2G	PSC	AL8E8F73C-8E1	5	PSC	DS	A3R1GE3CFF734MAA0E	.	.	
2G	PSC	PL8E8F73C-8E1	5	PSC	DS	SHG772-AA3G	.	.	
2G	PSC	PL8E8G73E-8E1	5	PSC	DS	XCP271A3G-A	.	.	
1G	GEIL	GB22GB6400C4DC	4	GEIL	DS	GL2L64M088BA30EB	.	.	
1G	GEIL	GB24GB6400C4QC	4	GEIL	DS	GL2L64M088BA30EB	.	.	
1G	GEIL	GB22GB6400C5DC	5	GEIL	DS	GL2L64M088BA30EB	.	.	
1G	GEIL	GB24GB6400C5QC	5	GEIL	DS	GL2L64M088BA30EB	.	.	
1G	GEIL	GX22GB6400DC	5	GEIL	DS	Heat-Sink Package	.	.	
1G	GEIL	GE22GB800C4DC	4	GEIL	DS	Heat-Sink Package	.	.	
1G	GEIL	GE24GB800C4QC	4	GEIL	DS	Heat-Sink Package	.	.	
1G	GEIL	GX22GB6400UDC	4	GEIL	DS	Heat-Sink Package	.	.	
1G	GEIL	GE22GB800C5DC	5	GEIL	DS	Heat-Sink Package	.	.	
1G	GEIL	GE24GB800C5QC	5	GEIL	DS	Heat-Sink Package	.	.	
2G	GEIL	GB24GB6400C4DC	4	GEIL	DS	GL2L128M88BA25AB	.	.	
2G	GEIL	GB24GB6400C5DC	5	GEIL	DS	GL2L128M88BA25AB	.	.	
2G	GEIL	GB28GB6400C5QC	5	GEIL	DS	GL2L128M88BA25AB	.	.	
2G	GEIL	GB28GB6400C4QC	4	GEIL	DS	GL2L128M88BA25AB	.	.	
2G	GEIL	GX22GB6400LX	5	GEIL	DS	Heat-Sink Package	.	.	

(continued on the next page)

DDR2 800

Size	Vendor	Part No.	CL	Chip Brand	SS/DS	Chip No.	DIMM support		
							A*	B*	C*
2G	GEIL	GX24GB6400DC	5	GEIL	DS	Heat-Sink Package	*	*	
2G	GEIL	GE28GB800C50C	5	GEIL	DS	Heat-Sink Package	*	*	
2G	GEIL	GE28GB800C40C	4	GEIL	DS	Heat-Sink Package	*	*	
2G	GEIL	GX22GB6400C0CSC	4	GEIL	DS	Heat-Sink Package	*	*	
2G	GEIL	GE24GB800C4DC	4	GEIL	DS	Heat-Sink Package	*	*	
2G	GEIL	GE24GB800C5DC	5	GEIL	DS	Heat-Sink Package	*	*	
1G	Super Talent	T800UB1GC4	4	Super Talent	DS	Heat-Sink Package	*	*	
1G	G.SKILL	F2-6400CL5D-2GBNQ	5	G.SKILL	DS	Heat-Sink Package	*	*	
1G	G.SKILL	F2-6400CL4D-2GBPK	4	G.SKILL	DS	Heat-Sink Package	*	*	
1G	G.SKILL	F2-6400CL4D-2GBHK	4	G.SKILL	DS	Heat-Sink Package	*	*	
2G	G.SKILL	F2-6400CL5D-4GBPQ	5	G.SKILL	DS	Heat-Sink Package	*	*	
2G	G.SKILL	F2-6400CL4D-4GBPK	4	G.SKILL	DS	Heat-Sink Package	*	*	
512MB	G.SKILL	F2-6400CL5D-1GBNQ	5	G.SKILL	DS	Heat-Sink Package SN:8151030036642	*	*	
4G	G.SKILL	F2-6400CL5Q-16GNQ	5	G.SKILL	DS	Heat-Sink Package	*	*	
1G	OCZ	OCZ2RPR8002GK	4	OCZ	DS	Heat-Sink Package	*	*	
1G	OCZ	OCZ2G800R22GK	5	OCZ	DS	Heat-Sink Package	*	*	
1G	OCZ	OCZ2P800R22GK	4	OCZ	DS	Heat-Sink Package	*	*	
1G	OCZ	OCZ2VU8004GK	6	OCZ	DS	Heat-Sink Package	*	*	
2G	OCZ	OCZ2P8004GK	5	OCZ	DS	Heat-Sink Package	*	*	
1G	Elixir	M2Y1G64TU8HB0B-25C	5	Elixir	DS	N2TU51280BE-25C802006Z1DV	*	*	
512MB	AENEON	AET660UD00-25DB98X	N/A	AENEON	SS	AET93F25DB 0621	*	*	
1G	AENEON	AET760UD00-25DB97X	5	AENEON	DS	AET93R25DB 0640	*	*	
1G	AENEON	AET760UD00-25DC08X	5	AENEON	SS	AET03R25OC 0732	*	*	*
512MB	MDT	MDT 512MB	5	MDT	SS	18D51280D-2.50726F	*	*	*
512MB	TAKEMS	TMS51B264C081-805EP	5	takeMS	SS	MS18T51280-2.5P0710	*	*	
1G	TAKEMS	TMS1GB264C081-805AE	5	takeMS	DS	MS18T51280-25FEA0709A	*	*	
1G	TAKEMS	TMS1GB264C081-805EP	5	takeMS	DS	MS18T51280-2.5P0716	*	*	
1G	ASINT	SLY2128M8-JGE	N/A	ASINT	SS	DDR11208-GE 8115	*	*	
2G	ASINT	SLZ2128M8-JGE	N/A	ASINT	DS	DDR11208-GE 8115	*	*	
1G	UMAX	D48001GP3-63BJU	N/A	UMAX	DS	U2S12D30TP-8E	*	*	
2G	UMAX	D48002GP0-73BCU	5	UMAX	DS	U2S24D30TP-8E	*	*	

(continued on the next page)

DDR2 1066

Size	Vendor	Part No.	CL	Chip Brand	SS/ DS	Chip No.	DIMM support		
							A*	B*	C*
512MB	Kingston	KHX8500D2/512	N/A	Kingston	SS	Heat-Sink Package	.	.	.
512MB	Kingston	KVR1066D2N7/512	N/A	Elpida	SS	E5108AJBG-1J-E	.	.	.
512MB	Kingston	KHX8500D2K2/1GN	N/A	Kingston	SS	Heat-Sink Package	.	.	.
1G	Kingston	KHX8500D2K2/2GN	N/A	Kingston	DS	Heat-Sink Package	.	.	.
1G	Kingston	KVR1066D2N7/1G	N/A	Elpida	DS	E5108AJBG-1J-E	.	.	.
1G	Kingston	KHX8500D2/1G	N/A	Kingston	DS	Heat-Sink Package	.	.	.
1G	Qimonda	HYS64T128020EU-19F-C	6	Qimonda	DS	HYB18T512800CF19FFSS24313	.	.	.
1G	Kingmax	KLED48F-A8K15	N/A	Kingmax	DS	KKA8FFIXF-JFS-18A	.	.	.
1G	Corsair	CM2X1024-8500C5	N/A	Corsair	DS	Heat-Sink Package	.	.	.
1G	Corsair	CM2X1024-8500C5D	5-5-5-15	Corsair	SS	Heat-Sink Package	.	.	.
1G	Transcend	TX1066QLJ-2GK1GB	5	Transced	DS	Heat-Sink Package	.	.	.
2G(kit of 2)	Transcend	TX1066QLJ-2GK	5	Transced	SS	Heat-Sink Package	.	.	.
2G(kit of 2)	OCZ	OCZ2N1066SR2DK	5-5-5-15	OCZ	DS	Heat-Sink Package(EPP) SN:00482080600160-1	.	.	.
1G	GEIL	GB24GB88500C5QC	5	GEIL	SS	GL2L128M88BA25AB	.	.	.
1G	GEIL	GE22GB1066C5DC	5	GEIL	SS	Heat-Sink Package	.	.	.
1G	GEIL	GE24GB1066C5QC	5	GEIL	DS	Heat-Sink Package	.	.	.
2G	GEIL	GB24GB88500C5DC	5	GEIL	DS	GL2L128M88BA25AB	.	.	.
2G	GEIL	GE24GB1066C5DC	5	GEIL	DS	Heat-Sink Package	.	.	.
4G(kit of 2)	GEIL	GX24GB88500C5UDC	5	N/A	DS	Heat-Sink Package	.	.	.
2G(kit of 2)	G.SKILL	F2-8500CL5D-2GBPK	5-5-5-15	N/A	DS	Heat-Sink Package	.	.	.
4G(kit of 2)	G.SKILL	F2-8500CL5D-4GBPK	5-5-5-15	N/A	DS	Heat-Sink Package	.	.	.
1G	G.SKILL	F2-8500CL5S-1GBPK	5-5-5-15	G.SKILL	DS	Heat-Sink Package	.	.	.
512MB	Kingbox	EP512D21066PS	N/A	Micron	SS	6QD22D9GCT	.	.	.
4G(kit of 2)	AENEON	AXT860UD20-19E	N/A	AENEON	DS	Heat-Sink Package	.	.	.
1G	AENEON	AXT760UD00-19DC97X	5	AENEON	DS	Heat-Sink Package	.	.	.
1G(kit of 2)	Crucial	BL12864AA106A.8FE5	5-5-5-15	Crucial	SS	Heat-Sink Package	.	.	.
1G(kit of 2)	Crucial	BL12864AA106A.8FE5 (EPP)	5-5-5-15	Crucial	SS	Heat-Sink Package	.	.	.



SS - Single-sided / DS - Double - sided

DIMM support:

- **A*:** Supports one module inserted in any slot as Single-channel memory configuration.
- **B*:** Supports one pair of modules inserted into either the yellow slots or the black slots as one pair of Dual-channel memory configuration.
- **C*:** Supports four modules inserted into both the yellow and black slots as two pairs of Dual-channel memory configuration.



Visit the ASUS website for the latest DDR2-1066/800/667 MHz QVL.

1.7.3 Installing a DIMM



Unplug the power supply before adding or removing DIMMs or other system components. Failure to do so can cause severe damage to both the motherboard and the components.

1. Unlock a DDR2 DIMM socket by pressing the retaining clips outward.
2. Align a DIMM on the socket such that the notch on the DIMM matches the break on the socket.

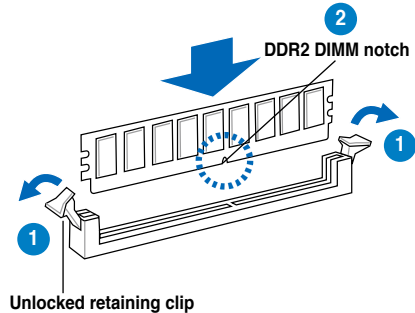

A DDR2 DIMM is keyed with a notch so that it fits in only one direction. DO NOT force a DIMM into a socket to avoid damaging the DIMM.

3. Firmly insert the DIMM into the socket until the retaining clips snap back in place and the DIMM is properly seated.

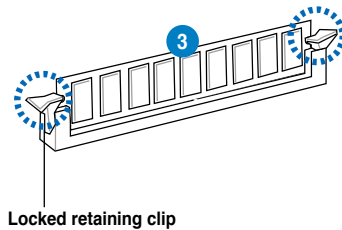

1.7.4 Removing a DIMM

To remove a DIMM:

1. Simultaneously press the retaining clips outward to unlock the DIMM.



Support the DIMM lightly with your fingers when pressing the retaining clips. The DIMM might get damaged when it flips out with extra force.

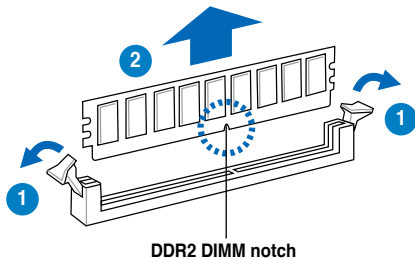

2. Remove the DIMM from the socket.

1.8 Expansion slots

In the future, you may need to install expansion cards. The following sub-sections describe the slots and the expansion cards that they support.



Ensure to unplug the power cord before adding or removing expansion cards. Failure to do so may cause you physical injury and damage motherboard components.

1.8.1 Installing an expansion card

To install an expansion card:

1. Before installing the expansion card, read the documentation that came with it and make the necessary hardware settings for the card.
2. Remove the system unit cover (if your motherboard is already installed in a chassis).
3. Remove the bracket opposite the slot that you intend to use. Keep the screw for later use.
4. Align the card connector with the slot and press firmly until the card is completely seated on the slot.
5. Secure the card to the chassis with the screw you removed earlier.
6. Replace the system cover.

1.8.2 Configuring an expansion card

After installing the expansion card, configure it by adjusting the software settings.

1. Turn on the system and change the necessary BIOS settings, if any. See Chapter 2 for information on BIOS setup.
2. Assign an IRQ to the card. Refer to the tables on the next page.
3. Install the software drivers for the expansion card.



When using PCI cards on shared slots, ensure that the drivers support “Share IRQ” or that the cards do not need IRQ assignments. Otherwise, conflicts will arise between the two PCI groups, making the system unstable and the card inoperable. Refer to the table on the next page for details.

1.8.3 Interrupt assignments

Standard interrupt assignments

IRQ	Priority	Standard Function
0	1	System Timer
1	2	Keyboard Controller
2	—	—
3	11	IRQ holder for PCI steering*
4	12	Communications Port (COM1)
5	13	Standard IRQ holder for PCI steering
6	14	Floppy Disk Controller
7	15	Printer Port (LPT1)
8	3	System CMOS/Real Time Clock
9	4	Microsoft ACPI-Compliant System
10	5	IRQ holder for PCI steering*
11	6	IRQ holder for PCI steering*
12	7	PS/2 Compatible Mouse Port
13	8	Numeric Data Processor
14	9	Primary IDE Channel

* These IRQs are usually available for PCI devices.

IRQ assignments for this motherboard

	A	B	C	D	E	F	G	H
PCI1	shared	shared	shared	shared	—	—	—	—
PCI2	shared	shared	shared	shared	—	shared	—	—
LAN(8111C)	—	shared	—	—	—	—	—	—
PCIEX16	shared	shared	shared	shared	—	—	—	—
PCIEX1	shared	shared	shared	shared	—	—	—	—
USB controller 1	—	—	—	—	—	—	—	shared
USB controller 2	—	—	—	shared	—	—	—	—
USB controller 3	—	—	shared	—	—	—	—	—
USB controller 4	shared	—	—	—	—	—	—	—
USB 2.0 controller	—	—	—	—	—	—	—	shared
SATA controller	—	—	—	shared	—	—	—	—
Azalia audio	—	—	—	—	—	shared	—	—

1.8.4 PCI slots

The PCI slots support cards such as a LAN card, SCSI card, USB card, and other cards that comply with PCI specifications. The figure shows a LAN card installed on a PCI slot.

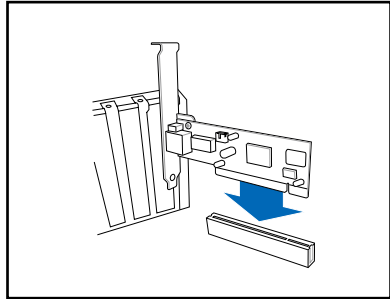

1.8.5 PCI Express x1 slot

This motherboard supports PCI Express x1 network cards, SCSI cards and other cards that comply with the PCI Express specifications. The following figure shows a network card installed on the PCI Express x1 slot.

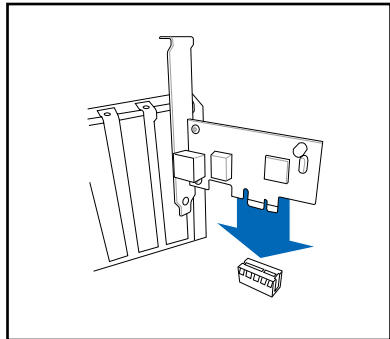

1.8.6 PCI Express x16 slot

This motherboard supports PCI Express x16 graphic cards that comply with the PCI Express specifications. The figure shows a graphics card installed on the PCI Express x16 slot.

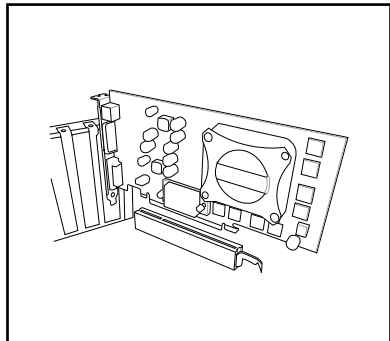

1.9 Jumper

1. Clear RTC RAM (3-pin CLRRTC)

This jumper allows you to clear the Real Time Clock (RTC) RAM in CMOS. You can clear the CMOS memory of date, time, and system setup parameters by erasing the CMOS RTC RAM data. The onboard button cell battery powers the RAM data in CMOS, which include system setup information such as system passwords.

To erase the RTC RAM:

1. Turn OFF the computer and unplug the power cord.
2. Move the jumper cap from pins 1-2 (default) to pins 2-3. Keep the cap on pins 2-3 for about 5~10 seconds, then move the cap back to pins 1-2.
3. Plug the power cord and turn ON the computer.
4. Hold down the key during the boot process and enter BIOS setup to re-enter data.



Except when clearing the RTC RAM, never remove the cap on CLRRTC jumper default position. Removing the cap will cause system boot failure!

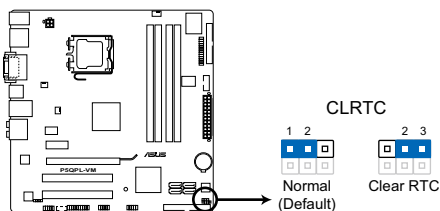

P5QPL-VM Clear RTC RAM



- If the steps above do not help, remove the onboard battery and move the jumper again to clear the CMOS RTC RAM data. After the CMOS clearance, reinstall the battery.
- You do not need to clear the RTC when the system hangs due to overclocking. For system failure due to overclocking, use the C.P.R. (CPU Parameter Recall) feature. Shut down and reboot the system so the BIOS can automatically reset parameter settings to default values.
- Due to the chipset limitation, AC power off is required prior using C.P.R. function. You must turn off and on the power supply or unplug and plug the power cord before reboot the system.

1.10 Connectors

1.10.1 Rear panel connectors

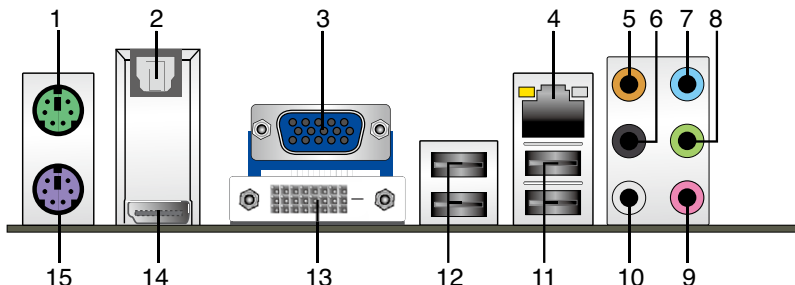

1. **PS/2 mouse port (green).** This port is for a PS/2 mouse.
2. **Optical S/PDIF Out port.** This port connects an external audio output device via an optical S/PDIF cable.
3. **Video Graphics Adapter (VGA) port.** This 15-pin port is for a VGA monitor or other VGA-compatible devices.
4. **LAN (RJ-45) port.** Supported by PCIe Gigabit LAN controller, this port allows Gigabit connection to a Local Area Network (LAN) through a network hub. Refer to the table below for the LAN port LED indications.

LAN port LED indications

Activity/Link LED		Speed LED	
Status	Description	Status	Description
OFF	No link	OFF	10 Mbps connection
ORANGE	Linked	ORANGE	100 Mbps connection
BLINKING	Data activity	GREEN	1 Gbps connection

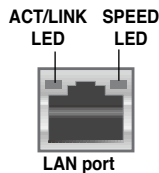

5. **Center/Subwoofer port (orange).** This port connects the center/subwoofer speakers.
6. **Rear Speaker Out port (black).** This port connects the rear speakers in a 4-channel, 6-channel, or 8-channel audio configuration.
7. **Line In port (light blue).** This port connects the tape, CD, DVD player, or other audio sources.
8. **Line Out port (lime).** This port connects a headphone or a speaker. In 4-channel, 6-channel, and 8-channel configuration, the function of this port becomes Front Speaker Out.
9. **Microphone port (pink).** This port connects a microphone.
10. **Side Speaker Out port (gray).** This port connects the side speakers in an 8-channel audio configuration.



Refer to the audio configuration table below for the function of the audio ports in 2, 4, 6 or 8-channel configuration.

Audio 2, 4, 6, or 8-channel configuration

Port	Headset 2-channel	4-channel	6-channel	8-channel
Light Blue	Line In	Line In	Line In	Line In
Lime	Line Out	Front Speaker Out	Front Speaker Out	Front Speaker Out
Pink	Mic In	Mic In	Mic In	Mic In
Orange	–	–	Center/Subwoofer	Center/Subwoofer
Black	–	Rear Speaker Out	Rear Speaker Out	Rear Speaker Out
Gray	–	–	–	Side Speaker Out

- USB 2.0 ports 1 and 2.** These two 4-pin Universal Serial Bus (USB) ports are available for connecting USB 2.0 devices.
- USB 2.0 ports 3 and 4.** These two 4-pin Universal Serial Bus (USB) ports are available for connecting USB 2.0 devices.
- DVI port.** This port is for any DVI-D compatible device. DVI-D can't be converted to output RGB Signal to CRT and isn't compatible with DVI-I.
- DisplayPort.** This port connects a display monitor or a home-theater system.



- Due to chipset limitation, DisplayPort on this motherboard only supports video signals.
- DisplayPort does not support DVI on this motherboard.

- PS/2 keyboard port (purple).** This port is for a PS/2 keyboard.

1.10.2 Internal connectors

1. Floppy disk drive connector (34-1 pin FLOPPY)

This connector is for the floppy disk drive (FDD) signal cable. Insert one end of the cable to this connector, then connect the other end to the signal connector at the back of the floppy disk drive.



- Pin 5 on the connector is removed to prevent incorrect cable connection when using an FDD cable with a covered Pin 5.
- The floppy disk drive cable is purchased separately.

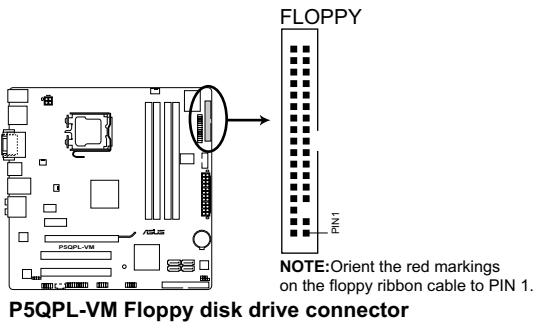

2. Serial port connectors (10-1 pin COM1)

The connector is for a serial (COM) port. Connect the serial port module cable to the connector, then install the module to a slot opening at the back of the system chassis.



The serial port bracket (COM1) is purchased separately.

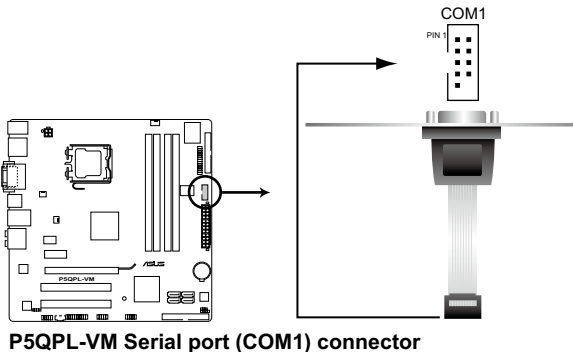

3. IDE connector (40-1 pin PRI_IDE)

The onboard IDE connector is for the Ultra DMA 100/66 signal cable. There are three connectors on each Ultra DMA 100/66 signal cable: blue, black, and gray. Connect the blue connector to the motherboard's IDE connector, then select one of the following modes to configure your device.

	Drive jumper setting	Mode of device(s)	Cable connector
Single device	Cable-Select or Master	-	Black
Two devices	Cable-Select	Master	Black
		Slave	Gray
	Master	Master	Black or gray
		Slave	



- Pin 20 on the IDE connector is removed to match the covered hole on the Ultra DMA cable connector. This prevents incorrect insertion when you connect the IDE cable.
- Use the 80-conductor IDE cable for Ultra DMA 100/66 IDE devices.



If any device jumper is set as "Cable-Select," ensure that all other device jumpers have the same setting.

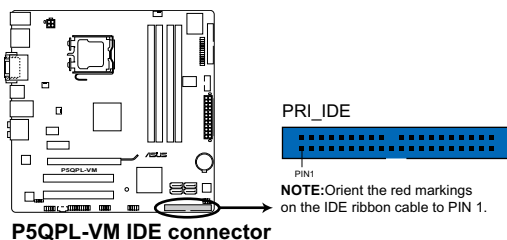

4. ICH7 Serial ATA connectors (7-pin SATA1, SATA2, SATA3, SATA4)

These connectors are for the Serial ATA signal cables for Serial ATA hard disk drives.

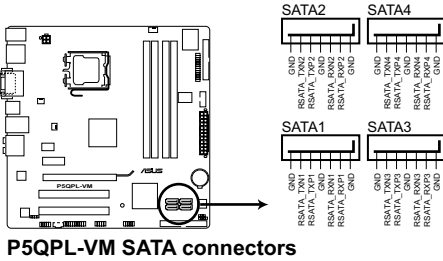

P5QPL-VM SATA connectors



Connect the right-angle side of SATA signal cable to SATA device. Or you may connect the right-angle side of SATA cable to the onboard SATA port to avoid mechanical conflict with huge graphics cards.

right angle side

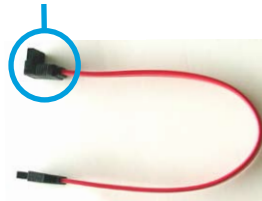

5. LPT connector (26-1 pin LPT)

The LPT (Line Printing Terminal) connector supports devices such as a printer. LPT standardizes as IEEE 1394, which is the parallel port interface on IBM PC-compatible computers.

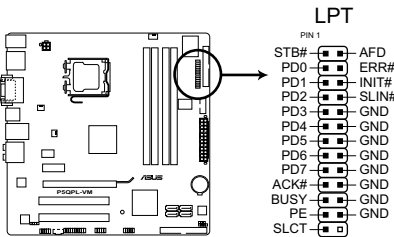

P5QPL-VM Parallel Port Connector

6. USB connectors (10-1 pin USB56, USB78)

These connectors are for USB 2.0 ports. Connect the USB module cable to any of these connectors, then install the module to a slot opening at the back of the system chassis. These USB connectors comply with USB 2.0 specification that supports up to 480 Mbps connection speed.

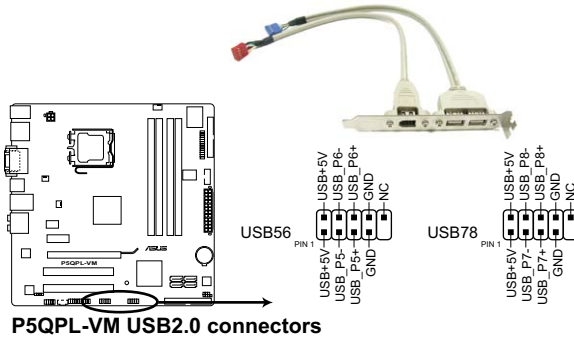

Never connect a 1394 cable to the USB connectors. Doing so will damage the motherboard!



The USB module is purchased separately.

7. Optical drive audio connector (4-pin CD)

These connectors allow you to receive stereo audio input from sound sources such as a CD-ROM, TV tuner, or MPEG card.

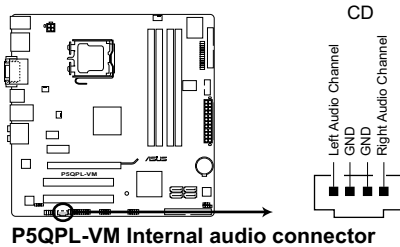

8. CPU, chassis and power fan connectors (4-pin CPU_FAN, 3-pin CHA_FAN, 3-pin PWR_FAN)

The fan connectors support cooling fans of 350 mA ~ 2000 mA (24 W max.) or a total of 1 A ~ 7 A (84 W max.) at +12V. Connect the fan cables to the fan connectors on the motherboard, ensuring that the black wire of each cable matches the ground pin of the connector.



DO NOT forget to connect the fan cables to the fan connectors. Insufficient air flow inside the system may damage the motherboard components. These are not jumpers! **DO NOT** place jumper caps on the fan connectors!

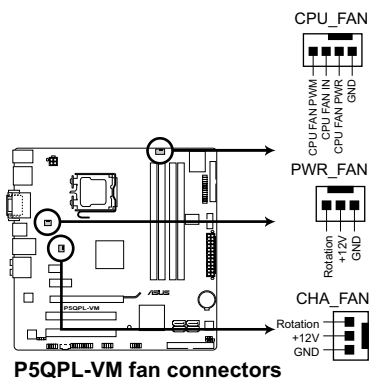

The CPU fan and chassis connectors support the ASUS Q-Fan feature.

9. Chassis intrusion connector (4-1 pin CHASSIS)

This connector is for a chassis-mounted intrusion detection sensor or switch. Connect one end of the chassis intrusion sensor or switch cable to this connector. The chassis intrusion sensor or switch sends a high-level signal to this connector when a chassis component is removed or replaced. The signal is then generated as a chassis intrusion event.

By default, the pin labeled “Chassis Signal” and “Ground” are shorted with a jumper cap. Remove the jumper caps only when you intend to use the chassis intrusion detection feature.

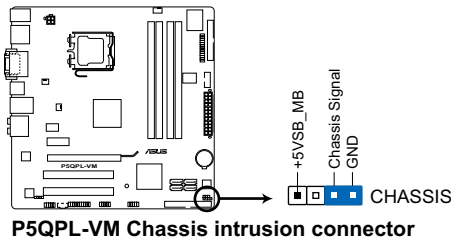

10. Front panel audio connector (10-1 pin AAFP)

This connector is for a chassis-mounted front panel audio I/O module that supports either HD Audio or legacy AC'97 audio standard.

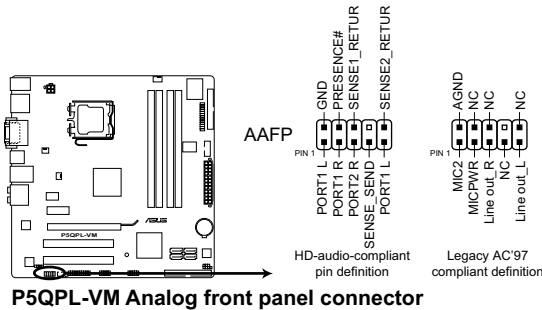

- We recommend that you connect a high-definition front panel audio module to this connector to avail of the motherboard's high-definition audio capability.
- By default, this connector is set to HD Audio. If you want to connect a High Definition front panel audio module to this connector, set the **Front Panel Type** item in the BIOS to [HD Audio]. See section “2.4.3 Chipset” for details.

11. Digital Audio connector (4-1 pin SPDIF_OUT)

This connector is for the S/PDIF audio module to allow digital sound output. Connect one end of the S/PDIF audio cable to this connector and the other end to the S/PDIF module.

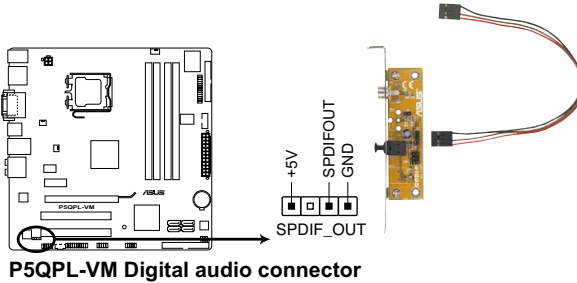

P5QPL-VM Digital audio connector



The S/PDIF out module is purchased separately.

12. ATX power connectors (24-pin EATXPWR, 4-pin ATX12V)

These connectors are for ATX power supply plugs. The power supply plugs are designed to fit these connectors in only one orientation. Find the proper orientation and push down firmly until the connectors completely fit.

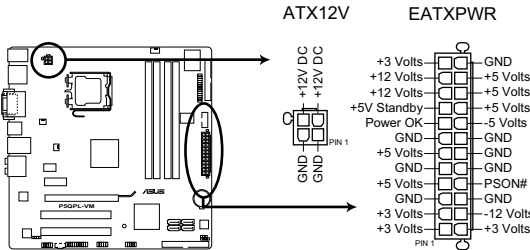

P5QPL-VM ATX power connectors



- For a fully configured system, we recommend that you use a power supply unit (PSU) that complies with ATX 12 V Specification 2.0 (or later version) and provides a minimum power of 400 W.
- **DO NOT** forget to connect the 4-pin ATX12V power plug; otherwise, the system will not boot.
- Use of a PSU with a higher power output is recommended when configuring a system with more power-consuming devices. The system may become unstable or may not boot up if the power is inadequate.
- The ATX 12 V Specification 2.0-compliant (400W) PSU has been tested to support the motherboard power requirements.

13. System panel connector (20-8 pin PANEL)

This connector supports several chassis-mounted functions.

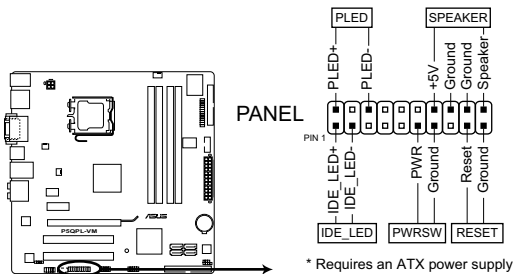

P5QPL-VM System panel connector

- **System power LED (2-pin PLED)**

This 2-pin connector is for the system power LED. Connect the chassis power LED cable to this connector. The system power LED lights up when you turn on the system power, and blinks when the system is in sleep mode.

- **Hard disk drive activity LED (2-pin +IDE_LED)**

This 2-pin connector is for the HDD Activity LED. Connect the HDD Activity LED cable to this connector. The IDE LED lights up or flashes when data is read from or written to the HDD.

- **System warning speaker (4-pin SPEAKER)**

This 4-pin connector is for the chassis-mounted system warning speaker. The speaker allows you to hear system beeps and warnings.

- **ATX power button/soft-off button (2-pin PWRSW)**

This connector is for the system power button. Pressing the power button turns the system on or puts the system in sleep or soft-off mode depending on the BIOS settings. Pressing the power switch for more than four seconds while the system is ON turns the system OFF.

- **Reset button (2-pin RESET)**

This 2-pin connector is for the chassis-mounted reset button for system reboot without turning off the system power.

This chapter tells how to change the system settings through the BIOS Setup menus. Detailed descriptions of the BIOS parameters are also provided.

BIOS setup **2**

2.1 Managing and updating your BIOS

The following utilities allow you to manage and update the motherboard Basic Input/Output System (BIOS) setup.

1. **ASUS Update:** Updates the BIOS in Windows® environment.
2. **ASUS EZ Flash 2:** Updates the BIOS using a floppy disk or USB flash disk.
3. **ASUS AFUDOS:** Updates the BIOS using a bootable floppy disk or USB flash disk.
4. **ASUS CrashFree BIOS 3:** Updates the BIOS using a bootable floppy disk, USB flash disk or the motherboard support DVD when the BIOS file fails or gets corrupted.

Refer to the corresponding sections for details on these utilities.



Save a copy of the original motherboard BIOS file to a bootable floppy disk or USB flash disk in case you need to restore the BIOS in the future. Copy the original motherboard BIOS using the ASUS Update or AFUDOS utilities.

2.1.1 ASUS Update utility

The ASUS Update is a utility that allows you to manage, save, and update the motherboard BIOS in Windows® environment. The ASUS Update utility allows you to:

- Save the current BIOS file
- Download the latest BIOS file from the Internet
- Update the BIOS from an updated BIOS file
- Update the BIOS directly from the Internet, and
- View the BIOS version information.

This utility is available in the support DVD that comes with the motherboard package.



ASUS Update requires an Internet connection either through a network or an Internet Service Provider (ISP).

Installing ASUS Update

To install ASUS Update:

1. Place the support DVD in the optical drive. The Drivers menu appears.
2. Click the **Utilities** tab, then click **Install ASUS Update**.
3. The ASUS Update utility is copied to your system.



Quit all Windows® applications before you update the BIOS using this utility.

Updating the BIOS through the Internet

To update the BIOS through the Internet:

1. Launch the ASUS Update utility from the Windows® desktop by clicking **Start > Programs > ASUS > ASUSUpdate > ASUSUpdate**. The ASUS Update main window appears.

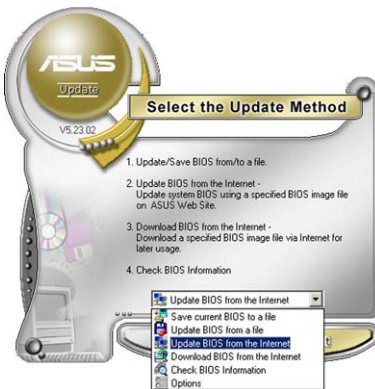
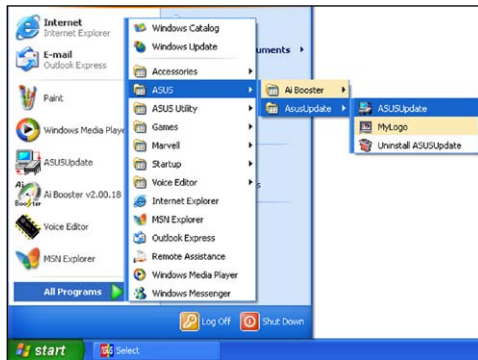

2. Select **Update BIOS** from the Internet option from the drop-down menu, then click **Next**.



3. Select the ASUS FTP site nearest you to avoid network traffic, or click **Auto Select**. Click **Next**.

- From the FTP site, select the BIOS version that you wish to download. Click **Next**.
- Follow the screen instructions to complete the update process.



The ASUS Update utility is capable of updating itself through the Internet. Always update the utility to avail all its features.

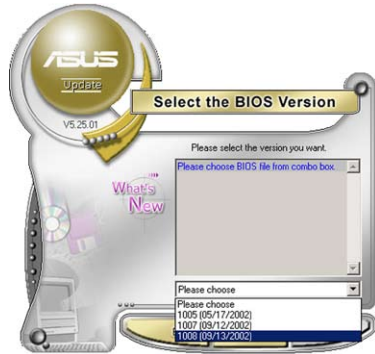

Updating the BIOS through a BIOS file

To update the BIOS through a BIOS file:

- Launch the ASUS Update utility from the Windows® desktop by clicking **Start > Programs > ASUS > ASUSUpdate > ASUSUpdate**. The ASUS Update main window appears.
- Select Update BIOS from a file option from the drop-down menu, then click **Next**.

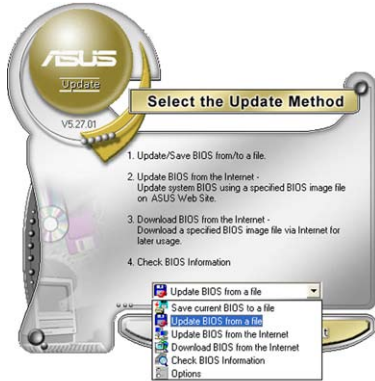

- Locate the BIOS file from the Open window, then click **Open**.
- Follow the screen instructions to complete the update process.

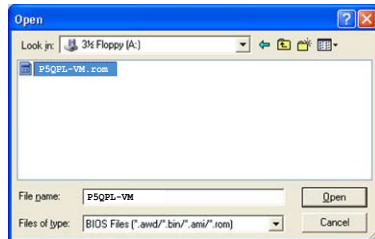

2.1.2 Creating a bootable floppy disk

1. Do either one of the following to create a bootable floppy disk.

DOS environment

- a. Insert a 1.44MB floppy disk into the drive.
- b. At the DOS prompt, type *format a: /s* then press <Enter>.

Windows® XP environment

- a. Insert a 1.44 MB floppy disk to the floppy disk drive.
- b. Click **Start** from the Windows® desktop, then select **My Computer**.
- c. Select the 3 1/2 Floppy Drive icon.
- d. Click File from the menu, then select **Format**. A **Format 3 1/2 Floppy Disk** window appears.
- e. Select **Create an MS-DOS startup disk** from the format options field, then click **Start**.

Windows® Vista environment

- a. Insert a formatted, high density 1.44 MB floppy disk to the floppy disk drive.
 - b. Click  from the Windows® desktop, then select **Computer**.
 - c. Right-click **Floppy Disk Drive** then click **Format** to display the **Format 3 1/2 Floppy** dialog box.
 - d. Select the **Create an MS-DOS startup disk** check box.
 - e. Click **Start**.
2. Copy the original or the latest motherboard BIOS file to the bootable floppy disk.

2.1.3 ASUS EZ Flash 2 utility

The ASUS EZ Flash 2 feature allows you to update the BIOS without having to go through the long process of booting from a floppy disk and using a DOS-based utility. The EZ Flash 2 utility is built-in the BIOS chip so it is accessible by pressing <Alt> + <F2> during the Power-On Self Tests (POST).

To update the BIOS using EZ Flash 2:

1. Visit the ASUS website (www.asus.com) to download the latest BIOS file for the motherboard.
2. Save the BIOS file to a floppy disk or a USB flash disk, then restart the system.
3. You can launch the EZ Flash 2 by two methods.

- (1) Insert the floppy disk / USB flash disk that contains the BIOS file to the floppy disk drive or the USB port.

Press <Alt> + <F2> during POST to display the following.

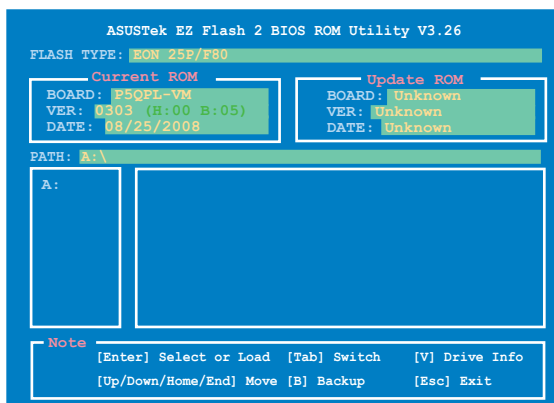

- (2) Enter BIOS setup program. Go to the **Tools** menu to select **EZ Flash2** and press <Enter> to enable it.

You can switch between drives by pressing <Tab> before the correct file is found. Then press <Enter>.

4. When the correct BIOS file is found, EZ Flash 2 performs the BIOS update process and automatically reboots the system when done.



- This function can support devices such as USB flash disk, or floppy disk with **FAT 32/16** format and single partition only.
- Do not shut down or reset the system while updating the BIOS to prevent system boot failure!

2.1.4 AFUDOS utility

The AFUDOS utility allows you to update the BIOS file in DOS environment using a bootable floppy disk or USB flash disk with the updated BIOS file. This utility also allows you to copy the current BIOS file that you can use as backup when the BIOS fails or gets corrupted during the updating process.

Copying the current BIOS

To copy the current BIOS file using the AFUDOS utility:



- Ensure that the floppy disk/USB flash disk is not write-protected and has at least 1024KB free space to save the file.
- The succeeding BIOS screens are for reference only. The actual BIOS screen displays may not be same as shown.

1. Copy the AFUDOS utility (afudos.exe) from the motherboard support DVD to the bootable floppy disk/USB flash disk you created earlier.
2. Boot the system in DOS mode, then at the prompt type:

```
afudos /o[filename]
```

where the [filename] is any user-assigned filename not more than eight alphanumeric characters for the main filename and three alphanumeric characters for the extension name.

```
A:\>afudos /oOLDBIOS1.rom
```

Main filename Extension name

3. Press <Enter>. The utility copies the current BIOS file to the floppy disk/USB flash disk.

```
A:\>afudos /oOLDBIOS1.rom
AMI Firmware Update Utility - Version 1.19(ASUS V2.07(03.11.24BB))
Copyright (C) 2002 American Megatrends, Inc. All rights reserved.
Reading flash ..... done
Write to file..... ok
A:\>
```

The utility returns to the DOS prompt after copying the current BIOS file.

Updating the BIOS file

To update the BIOS file using the AFUDOS utility:

1. Visit the ASUS website (www.asus.com) and download the latest BIOS file for the motherboard. Save the BIOS file to a bootable floppy disk/USB flash disk.



Write the BIOS filename on a piece of paper. You need to type the exact BIOS filename at the DOS prompt.

2. Copy the AFUDOS utility (afudos.exe) from the motherboard support DVD to the bootable floppy disk/USB flash disk you created earlier.
3. Boot the system in DOS mode, then at the prompt type:
afudos /i [filename]

where [filename] is the latest or the original BIOS file on the bootable floppy disk/USB flash disk.

```
A:\>afudos /iP5QPL-VM.ROM
```

4. The utility verifies the file and starts updating the BIOS.

```
A:\>afudos /iP5QPL-VM.ROM
AMI Firmware Update Utility - Version 1.19 (ASUS V2.07(03.11.24BB))
Copyright (C) 2002 American Megatrends, Inc. All rights reserved.

WARNING!! Do not turn off power during flash BIOS
Reading file ..... done
Reading flash ..... done

Advance Check .....
Erasing flash ..... done
Writing flash ..... 0x0008CC00 (9%)
```



Do not shut down or reset the system while updating the BIOS to prevent system boot failure!

5. The utility returns to the DOS prompt after the BIOS update process is completed. Reboot the system from the hard disk drive.

```
A:\>afudos /iP5QPL-VM.ROM
AMI Firmware Update Utility - Version 1.19 (ASUS V2.07(03.11.24BB))
Copyright (C) 2002 American Megatrends, Inc. All rights reserved.

WARNING!! Do not turn off power during flash BIOS
Reading file ..... done
Reading flash ..... done

Advance Check .....
Erasing flash ..... done
Writing flash ..... done
Verifying flash .... done

Please restart your computer

A:\>
```

2.1.5 ASUS CrashFree BIOS 3 utility

The ASUS CrashFree BIOS 3 is an auto recovery tool that allows you to restore the BIOS file when it fails or gets corrupted during the updating process. You can update a corrupted BIOS file using the motherboard support DVD, the floppy disk or the USB flash disk that contains the updated BIOS file.



- Prepare the motherboard support DVD, the floppy disk or the USB flash disk containing the updated motherboard BIOS before using this utility.
- Ensure that you rename the original or updated BIOS file in the floppy disk or the USB flash disk to **P5QPL-VM.ROM**.

Recovering the BIOS from a floppy disk

To recover the BIOS from a floppy disk:

1. Turn on the system.
2. Insert the floppy disk with the original or updated BIOS file to the floppy disk drive.
3. The utility displays the following message and automatically checks the floppy disk for the original or updated BIOS file.

```
Bad BIOS checksum. Starting BIOS recovery...  
Checking for floppy...
```

When found, the utility reads the BIOS file and starts flashing the corrupted BIOS file.

```
Bad BIOS checksum. Starting BIOS recovery...  
Checking for floppy...  
Floppy found!  
Reading file "P5QPL-VM.ROM". Completed.  
Start flashing...
```



DO NOT shut down or reset the system while updating the BIOS! Doing so can cause system boot failure!

4. Restart the system after the utility completes the updating process.



Install memory module in DIMM_A1 or DIMM_B1 slots.

Recovering the BIOS from the support DVD

To recover the BIOS from the support DVD:

1. Remove any floppy disk from the floppy disk drive, then turn on the system.
2. Insert the support DVD to the optical drive.
3. The utility displays the following message and automatically checks the floppy disk for the original or updated BIOS file.

```
Bad BIOS checksum. Starting BIOS recovery...
Checking for floppy...
```

When no floppy disk is found, the utility automatically checks the optical drive for the original or updated BIOS file. The utility then updates the corrupted BIOS file.

```
Bad BIOS checksum. Starting BIOS recovery...
Checking for floppy...
Floppy not found!
Checking for DVD-ROM...
DVD-ROM found!
Reading file "P5QPL-VM.ROM". Completed.
Start flashing...
```

4. Restart the system after the utility completes the updating process.



The recovered BIOS may not be the latest BIOS version for this motherboard. Visit the ASUS website (www.asus.com) to download the latest BIOS file.

Recovering the BIOS from the USB flash disk

To recover the BIOS from the USB flash disk:

1. Insert the USB flash disk that contains BIOS file to the USB port.
2. Turn on the system.
3. The utility will automatically checks the devices for the BIOS file. When found, the utility reads the BIOS file and starts flashing the corrupted BIOS file.
4. Restart the system after the utility completes the updating process.



- Only the USB flash disk with FAT 32/16 format and single partition can support ASUS CrashFree BIOS 3. The device size should be smaller than 8GB.
 - DO NOT shut down or reset the system while updating the BIOS! Doing so can cause system boot failure!
-

2.2 BIOS setup program

This motherboard supports a programmable Serial Peripheral Interface (SPI) chip that you can update using the provided utility described in section “2.1 Managing and updating your BIOS”.

Use the BIOS Setup program when you are installing a motherboard, reconfiguring your system, or prompted to “Run Setup”. This section explains how to configure your system using this utility.

Even if you are not prompted to use the Setup program, you can change the configuration of your computer in the future. For example, you can enable the security password feature or change the power management settings. This requires you to reconfigure your system using the BIOS Setup program so that the computer can recognize these changes and record them in the CMOS RAM of the SPI chip.

The SPI chip on the motherboard stores the Setup utility. When you start up the computer, the system provides you with the opportunity to run this program. Press during the Power-On Self-Test (POST) to enter the Setup utility. Otherwise, POST continues with its test routines.

If you wish to enter Setup after POST, reboot the system by doing any of the following procedures:

- Restart using the OS standard shut-down procedure.
- Press <Ctrl>+<Alt>+ simultaneously.
- Press the reset button on the system chassis.
- Press the power button to turn the system off then back on.



Using the **power button**, **reset button**, or the <Ctrl>+<Alt>+ keys to force reset from a running operating system can cause damage to your data or system. We recommend to always shut-down the system properly from the operating system.

The Setup program is designed to make it as easy to use as possible. Being a menu-driven program, it lets you scroll through the various sub-menus and make your selections from the available options using the navigation keys.



-
- The default BIOS settings for this motherboard apply for most conditions to ensure optimum performance. If the system becomes unstable after changing any BIOS settings, load the default settings to ensure system compatibility and stability. Select the **Load Default Settings** item under the Exit Menu. See section “2.8 Exit Menu.”
 - The BIOS setup screens shown in this section are for reference purposes only, and may not exactly match what you see on your screen.
 - Visit the ASUS website (www.asus.com) to download the latest BIOS file for this motherboard.
-

2.2.1 BIOS menu screen

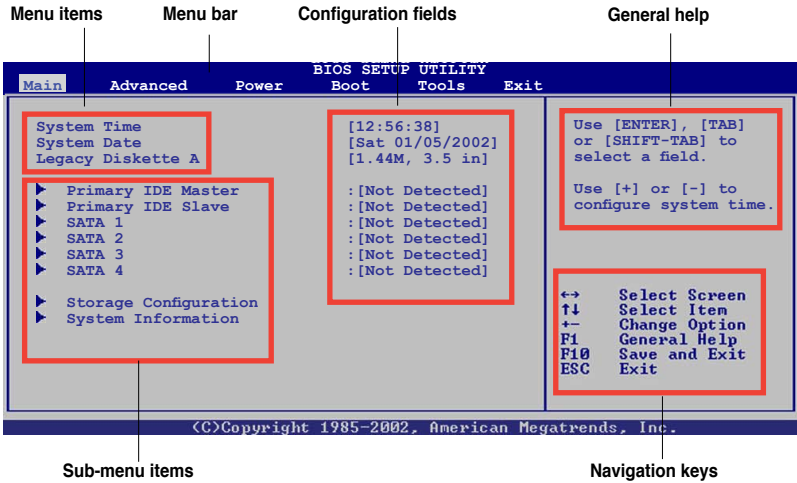

2.2.2 Menu bar

The menu bar on top of the screen has the following main items:

- Main** For changing the basic system configuration
- Advanced** For changing the advanced system settings
- Power** For changing the advanced power management (APM) configuration
- Boot** For changing the system boot configuration
- Tools** For configuring options for special functions
- Exit** For selecting the exit options and loading default settings

To select an item on the menu bar, press the right or left arrow key on the keyboard until the desired item is highlighted.

2.2.3 Navigation keys

At the bottom right corner of a menu screen are the navigation keys for that particular menu. Use the navigation keys to select items in the menu and change the settings.



Some of the navigation keys differ from one screen to another.

2.2.4 Menu items

The highlighted item on the menu bar displays the specific items for that menu. For example, selecting Main shows the Main menu items.

The other items (Advanced, Power, Boot, Tool, and Exit) on the menu bar have their respective menu items.



Main menu items

2.2.5 Sub-menu items

A solid triangle before each item on any menu screen means that the item has a sub-menu. To display the sub-menu, select the item and press <Enter>.

2.2.6 Configuration fields

These fields show the values for the menu items. If an item is user-configurable, you can change the value of the field opposite the item. You cannot select an item that is not user-configurable.

A configurable field is enclosed in brackets, and is highlighted when selected. To change the value of a field, select it then press <Enter> to display a list of options. Refer to “2.2.7 Pop-up window.”

2.2.7 Pop-up window

Select a menu item then press <Enter> to display a pop-up window with the configuration options for that item.

2.2.8 Scroll bar

A scroll bar appears on the right side of a menu screen when there are items that do not fit on the screen. Press the Up/Down arrow keys or <Page Up> /<Page Down> keys to display the other items on the screen.

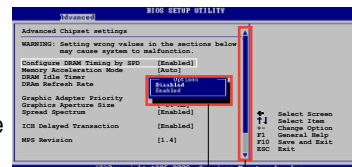

Pop-up window

Scroll bar

2.2.9 General help

At the top right corner of the menu screen is a brief description of the selected item.

2.3 Main menu

When you enter the BIOS Setup program, the Main menu screen appears, giving you an overview of the basic system information.



Refer to section "2.2.1 BIOS menu screen" for information on the menu screen items and how to navigate through them.

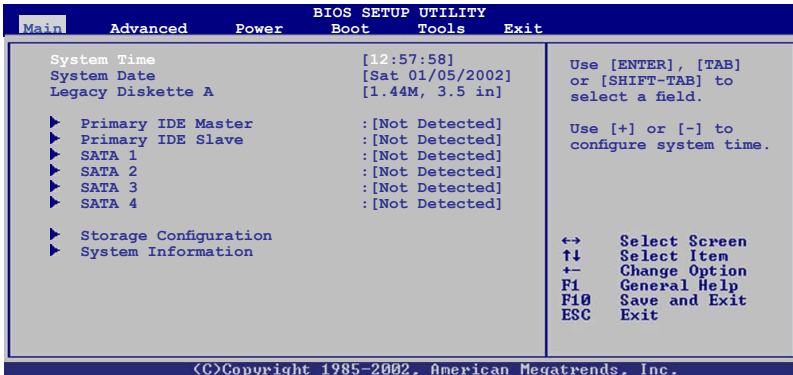

2.3.1 System Time [xx:xx:xx]

Allows you to set the system time.

2.3.2 System Date [Day xx/xx/xxxx]

Allows you to set the system date.

2.3.3 Legacy Diskette A [1.44M, 3.5 in.]

Sets the type of floppy drive installed. Configuration options: [Disabled] [360K, 5.25 in.] [1.2M, 5.25 in.] [720K, 3.5 in.] [1.44M, 3.5 in.] [2.88M, 3.5 in.]

2.3.4 Primary IDE Master/Slave, SATA1~4

While entering Setup, the BIOS automatically detects the presence of IDE devices. There is a separate sub-menu for each IDE device. Select a device item then press <Enter> to display the IDE device information.

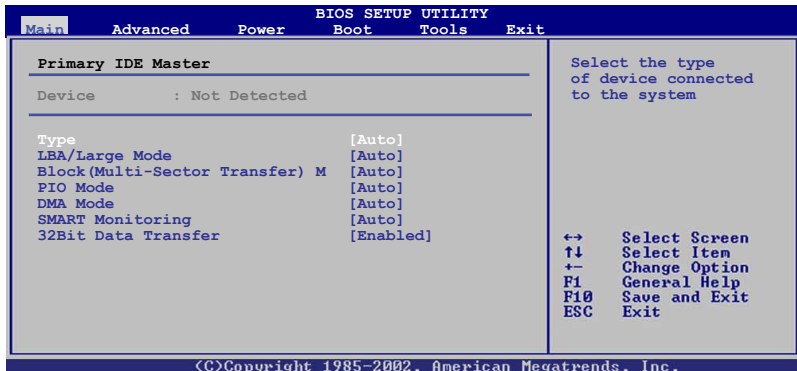

The BIOS automatically detects the values opposite the dimmed items (Device, Vendor, Size, LBA Mode, Block Mode, PIO Mode, Async DMA, Ultra DMA, and SMART monitoring). These values are not user-configurable. These items show N/A if no IDE device is installed in the system.

Type [Auto]

Selects the type of IDE drive. Setting to Auto allows automatic selection of the appropriate IDE device type. Select CDROM if you are specifically configuring a CD-ROM drive. Select ARMD (ATAPI Removable Media Device) if your device is either a ZIP, LS-120, or MO drive. Configuration options: [Not Installed] [Auto] [CDROM] [ARMD]



This item does appear when you select the **SATA 1/2/3/4** devices.

LBA/Large Mode [Auto]

Enables or disables the LBA mode. Setting to Auto enables the LBA mode if the device supports this mode, and if the device was not previously formatted with LBA mode disabled. Configuration options: [Disabled] [Auto]

Block (Multi-sector Transfer) M [Auto]

Enables or disables data multi-sectors transfers. When set to Auto, the data transfer from and to the device occurs multiple sectors at a time if the device supports multi-sector transfer feature. When set to [Disabled], the data transfer from and to the device occurs one sector at a time.

Configuration options: [Disabled] [Auto]

PIO Mode [Auto]

Selects the PIO mode. Configuration options: [Auto] [0] [1] [2] [3] [4]

DMA Mode [Auto]

Selects the DMA mode. Configuration options: [Auto]

SMART Monitoring [Auto]

Sets the Smart Monitoring, Analysis, and Reporting Technology. Configuration options: [Auto] [Disabled] [Enabled]

32Bit Data Transfer [Enabled]

Enables or disables 32-bit data transfer. Configuration options: [Disabled] [Enabled]

2.3.5 Storage Configuration

The items in this menu allow you to set or change the configurations for the IDE devices installed in the system. Select an item then press <Enter> if you wish to configure the item.

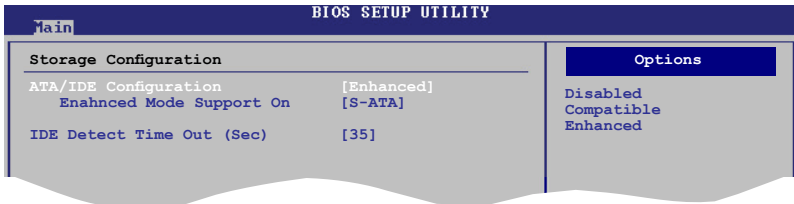

ATA/IDE Configuration [Enhanced]

Allows you to configure ATA/IDE. Configuration options: [Disabled] [Compatible] [Enhanced]

Enhanced Mode Support On [S-ATA]

Allows you to set Serial ATA, Parallel ATA or both as native mode.

Configuration options: [S-ATA+P-ATA] [S-ATA] [P-ATA]

IDE Detect Time Out [35]

Selects the time out value for detecting ATA/ATAPI devices.

Configuration options: [0] [5] [10] [15] [20] [25] [30] [35]

2.3.6 System Information

This menu gives you an overview of the general system specifications. The BIOS automatically detects the items in this menu.

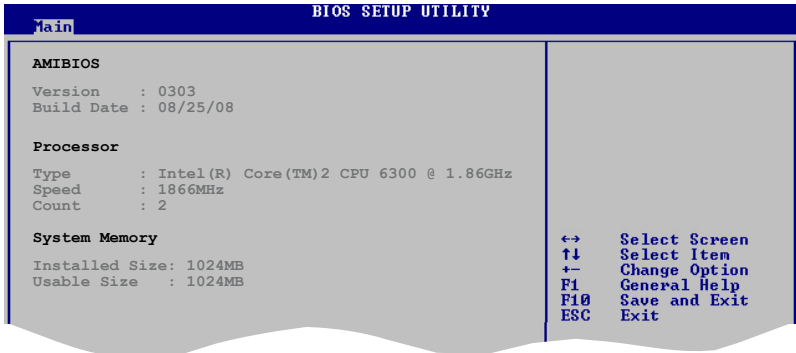

AMI BIOS

Displays the auto-detected BIOS information.

Processor

Displays the auto-detected CPU specification.

System Memory

Displays the auto-detected system memory.

2.4 Advanced menu

The Advanced menu items allow you to change the settings for the CPU and other system devices.



Take caution when changing the settings of the Advanced menu items. Incorrect field values can cause the system to malfunction.

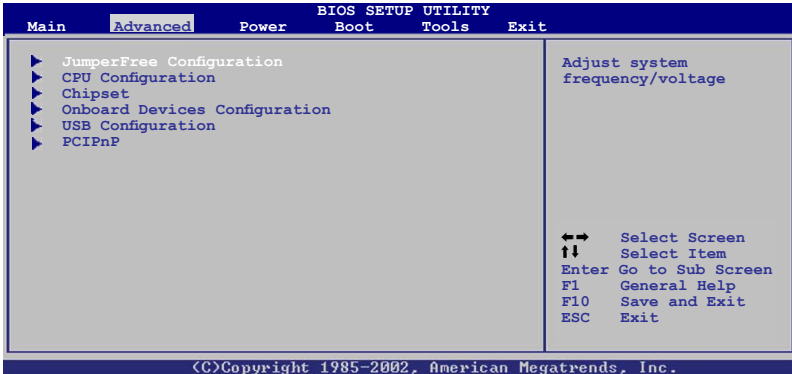

2.4.1 JumperFree Configuration

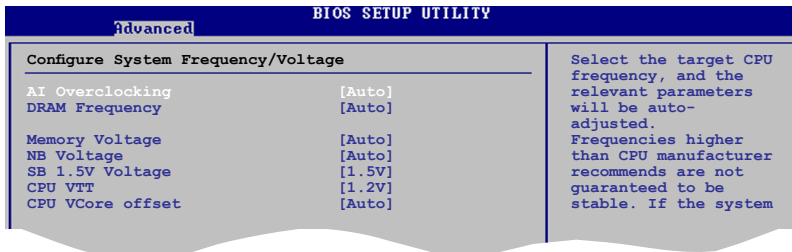

AI Overclocking [Auto]

Allows selection of CPU overclocking options to achieve desired CPU internal frequency. Select either one of the preset overclocking.

Configuration options: [MANUAL] [Auto] [Overclock Profile]



The following two items appear only when you set the AI Overclocking item to [MANUAL].

CPU Frequency [XXX]

Displays the frequency sent by the clock generator to the system bus and PCI bus. The value of this item is auto-detected by the BIOS. Use the <+> and <-> keys to adjust the CPU frequency. You can also type the desired CPU frequency using the numeric keypad. The values range from 133 to 500. Refer to the table below for the correct Front Side Bus and CPU External Frequency settings.

FSB / CPU External Frequency Synchronization

Front Side Bus	CPU External Frequency
FSB 1333	333 MHz
FSB 1066	266 MHz
FSB 800	200 MHz

PCI Express Frequency [Auto]

Allows you to select the PCI Express frequency. Configuration options: [Auto] [90] [91] [92]~[150]



The following item appears only when you set the AI Overclocking item to [Overclock Profile].

Overclock Options [Overclock 5%]

Allows you to select the overclock options. Configuration options: [Overclock 5%] [Overclock 10%] [Overclock 15%] [Overclock 20%] [Overclock 30%] [Test Mode]

DRAM Frequency [Auto]

Allows you to set the DDR2 operating frequency. Configuration options: [Auto] [667 MHz] [800 MHz] [1067 MHz]



The DRAM Frequency options vary with different FSB value. Refer to the following table for the DRAM Frequency options when the FSB value is 1333, 1066, and 800.

FSB	DRAM Frequency							
	Auto	667MHz	800MHz	960MHz	1000MHz	1067MHz	1100MHz	1200MHz
1333	•	•	•		•		•	
1066	•	•	•			•		
800	•	•	•					



Selecting a very high DRAM frequency may cause the system to become unstable! If this happens, revert to the default setting.

Memory Voltage

Allows you to set the Memory Voltage. Key in the value directly. Use +/- to adjust the voltage. The increment is 0.00625V. The standard value is 1.85000V.

Configuration options: [Auto] [Min = 1.850000V] [Max = 2.24375V]

NB Voltage [Auto]

Allows you to select the North Bridge voltage or set it to [Auto] mode.

Configuration options: [Auto] [1.125V] [1.175V] [1.225V] [1.275V]

SB 1.5 Voltage [1.5V]

Allows you to select the South Bridge voltage.

Configuration options: [1.5V] [1.6V]

CPU VTT [1.2V]

Allows you to select FSB termination voltage. Configuration options: [1.2V] [1.3V]

CPU Vcore offset [Auto]

Allows you to select CPU Vcore Voltage or set to [Auto] mode.

Configuration options: [Auto] [0mv] [50mv] [100mv] [150mv]

2.4.2 CPU Configuration

The items in this menu show the CPU-related information that the BIOS automatically detects.

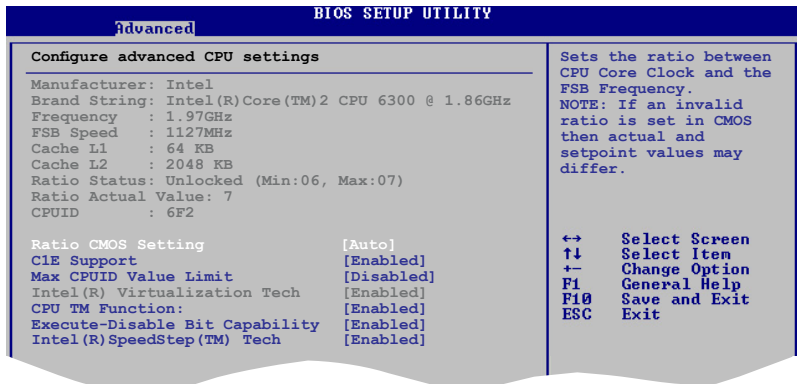

Ratio CMOS Setting [Auto]

Allows you to set the ratio between CPU Core Clock and the FSB frequency. Configuration option: [Auto]



- If an invalid ratio is set in CMOS then actual and set values may differ.
- Key in ratio numbers directly.

C1E Support [Enabled]

Allows you to enable or disable Inter CPU Enhanced Halt (C1E) function, a CPU power-saving function in system halt state. When enable, the CPU core frequency and voltage will be reduced during the system halt state to decrease power consumption. Configuration options: [Disabled] [Enabled]

Max CPUID Value Limit [Disabled]

Allows you to determine whether to limit CPUID maximum value. Set this item to [Disabled] for Windows XP operating system; set this item to [Enabled] for legacy operating system such as Windows NT4.0. (Default: Disabled) Configuration options: [Disabled] [Enabled]

Intel(R) Virtualization Tech [Enabled]

Enables or disables Intel® Virtualization Technology. Virtualization enhanced by Intel® Virtualization Technology allows a platform to run multiple operating systems and applications in independent partitions. With Virtualization, one computer system can function as multiple virtual systems. Configuration options: [Enabled] [Disabled]

CPU TM Function [Enabled]

Enables or disables Intel® CPU Thermal Monitor (TM) function, a CPU overheating protection function. When enabled, the CPU core frequency and voltage are reduced when the CPU overheats. Configuration options: [Disabled] [Enabled]

Execute-Disable Bit Capability [Enabled]

Enables or disables Intel® Execute Disable Bit function. This function enhance protection of your computer, reducing exposure to viruses and malicious buffer overflow attacks when working with its supporting software and system. Configuration options: [Disabled] [Enabled]



The following item appears only when you installed an Intel® Pentium® 4 or later CPU that supports the Enhanced Intel SpeedStep® Technology (EIST).

Intel(R) SpeedStep(TM) Technology [Enabled]

Allows you to use the Enhanced Intel® SpeedStep™ Technology. When set to [Enabled], you can adjust the system power settings in the operating system to use the EIST feature. Set this item to [Disabled] if you do not want to use the EIST. Configuration options: [Enabled] [Disabled]

2.4.3 Chipset

The Chipset menu allows you to change the advanced chipset settings. Select an item then press <Enter> to display the sub-menu.

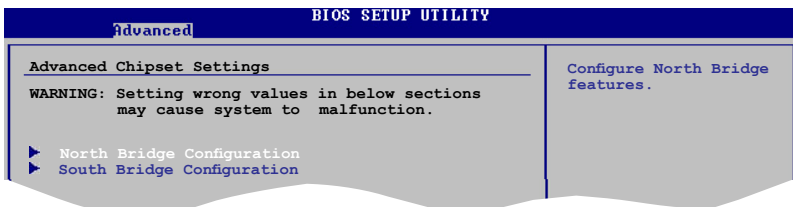

North Bridge Configuration

Advanced		BIOS SETUP UTILITY	
North Bridge chipset Configuration		ENABLE: Allow remapping of overlapped PCI memory above the total physical memory.	
Memory Remap Feature	[Enabled]	DISABLE: Do not allow remapping of memory	
Configure DRAM Timing by SPD	[Enabled]	↔ Select Screen	
Initiate Graphic Adapter	[PEG/PCI]	↑↓ Select Item	
IGD Graphics Mode Select	[Enabled, 32MB]		
GTT Graphics Memory Size	[No VT mode, 2MB]		
DVMT Memory	[256MB]		
Protect Audio Video Path Mode	[Lite]		

Memory Remap Feature [Enabled]

Allows you to enable or disable the remapping of overlapped PCI memory above the total physical memory. Configuration options: [Enabled] [Disabled]

Configure DRAM Timing by SPD [Enabled]

Allows you to enable or disable configuring DRAM Timing by SPD. Configuration options: [Enabled] [Disabled]

Initiate Graphic Adapter [PEG/PCI]

Allows you to select the graphics controller as the primary boot device. Configuration options: [IGD] [PCI/IGD] [PCI/PEG] [PEG/IGD] [PEG/PCI]

IGD Graphics Mode Select [Enabled, 32MB]

Allows you to select the amount of system memory used by the IGD graphics device. Configuration options: [Disabled] [Enabled, 32MB] [Enabled, 64MB] [Enabled, 128MB]

DVMT Memory [256MB]

Allows you to select the DVMT memory. Configuration options: [128MB] [256MB] [Maximum DVMT]



The [Maximum DVMT] option only appears when installing 1GB DDR2 DIMMs into the DIMM sockets.

Protect Audio Video Path Mode [Lite]

Allows you to set the Protected Audio Video Path (PAVP). Configuration options: [Disabled] [Lite] [Paranoid]

To use the High-Bandwidth Digital Content Protection (HDCP) function, set this option to either **[Lite]** or **[Paranoid]**. If you select Paranoid Mode, the system reserves 96MB for playing and storing the decrypted contents. The operation system and other programs cannot use this reserved memory, and Vista Aero (DWM) is disabled.

Feature	PAVP Lite	PAVP Paranoid
Compressed video buffer is encrypted	Yes	Yes
HW 128-bit AES decryption	Yes	Yes
Protected memory (96MB reserved during boot)	No	Yes

South Bridge Configuration

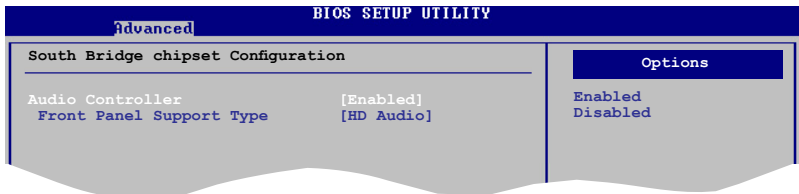

Audio Controller [Enabled]

Allows you to set the audio controller. Configuration options: [Enabled] [Disabled]



The following item does not appear when the **Audio Controller** item is set to [Disabled].

Front Panel Type [HD Audio]

Allows you to select the front panel support type. If High Definition Audio Front Panel is used, set this item to [HD Audio] mode.

Configuration options: [AC97] [HD Audio]

2.4.4 Onboard Devices Configuration

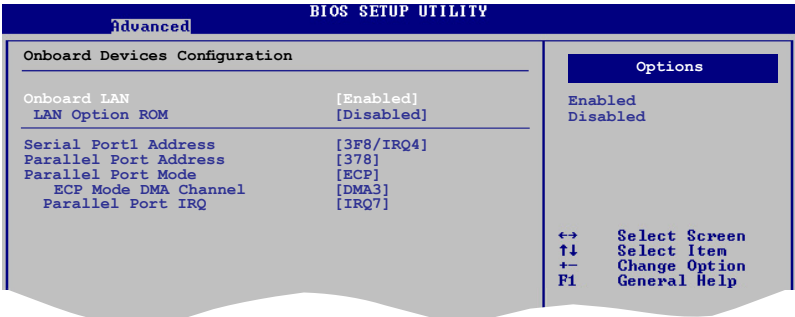

Onboard LAN [Enabled]

Allows you to enable or disable the onboard LAN controller.

Configuration options: [Enabled] [Disabled]

LAN Option ROM [Disabled]

Allows you to enable or disable the boot ROM in the onboard LAN controller.

This item appears only when the Onboard LAN item is set to Enabled.

Configuration options: [Disabled] [Enabled]

Serial Port1 Address [3F8/IRQ4]

Allows you to select the Serial Port1 base address.

Configuration options: [Disabled] [3F8/IRQ4] [2F8/IRQ3] [3E8/IRQ4] [2E8/IRQ3]

Parallel Port Address [378]

Allows you to select the Parallel Port base addresses.

Configuration options: [Disabled] [378] [278] [3BC]

Parallel Port Mode [ECP]

Allows you to select the Parallel Port mode.

Configuration options: [Normal] [Bi-Directional] [EPP] [ECP]

ECP Mode DMA Channel [DMA3]

Appears only when the **Parallel Port Mode** item is set to [ECP]. This item allows you to set the Parallel Port ECP DMA. Configuration options: [DMA0] [DMA1]

[DMA3]

Parallel Port IRQ [IRQ7]

Allows you to select parallel port IRQ. Configuration options: [IRQ5] [IRQ7]

2.4.5 USB Configuration

The items in this menu allows you to change the USB-related features. Select an item then press <Enter> to display the configuration options.

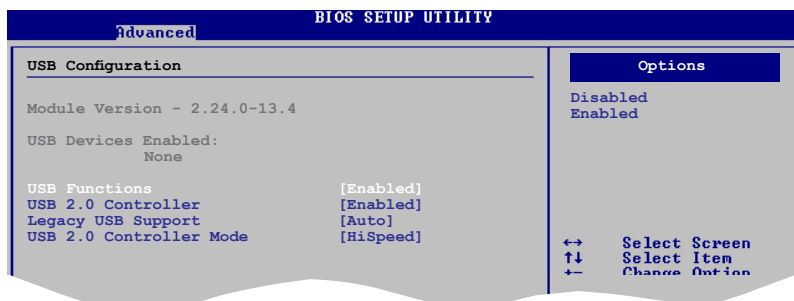

The Module Version and USB Devices Enabled items show the auto-detected values. If no USB device is detected, the item shows None.

USB Functions [Enabled]

Allows you to enable or disable the USB functions.

Configuration options: [Disabled] [Enabled]

USB 2.0 Controller [Enabled]

Allows you to enable or disable USB 2.0 controller.

Configuration options: [Enabled] [Disabled]

Legacy USB Support [Auto]

Allows you to enable or disable support for USB devices on legacy operating systems (OS). Setting to Auto allows the system to detect the presence of USB devices at startup. If detected, the USB controller legacy mode is enabled. If no USB device is detected, the legacy USB support is disabled.

Configuration options: [Disabled] [Enabled] [Auto]

USB 2.0 Controller Mode [HiSpeed]

Allows you to configure the USB 2.0 controller in HiSpeed (480 Mbps) or Full Speed (12 Mbps). Configuration options: [FullSpeed] [HiSpeed]

2.4.6 PCI PnP

The PCI PnP menu items allow you to change the advanced settings for PCI/PnP devices. The menu includes setting IRQ and DMA channel resources for either PCI/PnP or legacy ISA devices, and setting the memory size block for legacy ISA devices.



Take caution when changing the settings of the PCI PnP menu items. Incorrect field values can cause the system to malfunction.

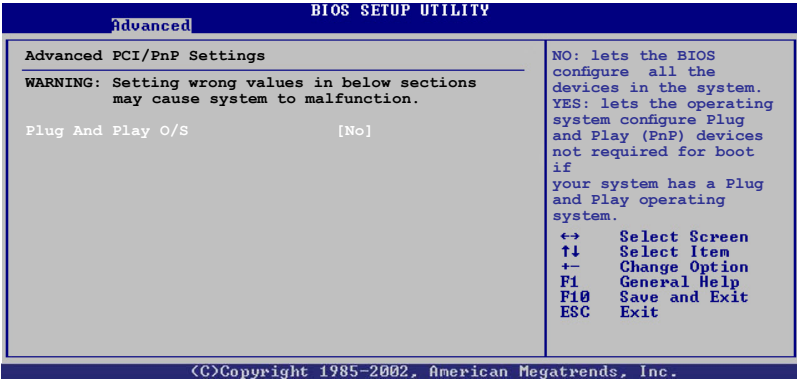

Plug And Play O/S [No]

When set to [No], BIOS configures all the devices in the system. When set to [Yes] and if you install a Plug and Play operating system, the operating system configures the Plug and Play devices not required for boot.

Configuration options: [No] [Yes]

2.5 Power menu

The Power menu items allow you to change the settings for the Advanced Power Management (APM). Select an item then press <Enter> to display the configuration options.

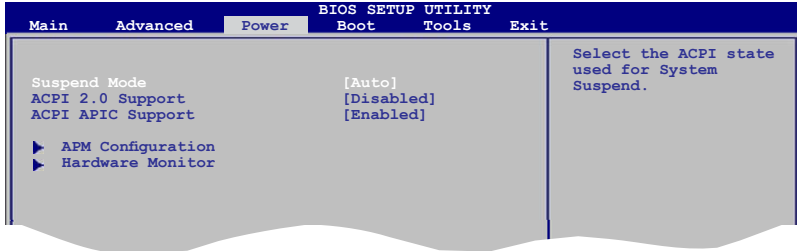

2.5.1 Suspend Mode [Auto]

Allows you to select the Advanced Configuration and Power Interface (ACPI) state to be used for system suspend. Configuration options: [S1 (POS) Only] [S3 Only] [Auto]

2.5.2 ACPI 2.0 Support [Disabled]

Allows you to add more tables for Advanced Configuration and Power Interface (ACPI) 2.0 specifications. Configuration options: [Disabled] [Enabled]

2.5.3 ACPI APIC Support [Enabled]

Allows you to enable or disable the Advanced Configuration and Power Interface (ACPI) support in the Application-Specific Integrated Circuit (ASIC). When set to Enabled, the ACPI APIC table pointer is included in the RSDT pointer list. Configuration options: [Disabled] [Enabled]

2.5.4 APM Configuration

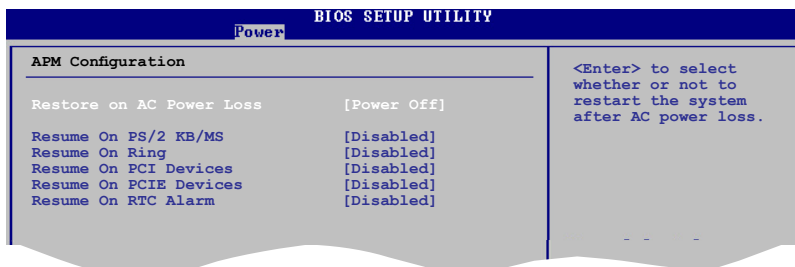

Restore on AC Power Loss [Power Off]

When set to [Power Off], the system goes into off state after an AC power loss. When set to [Power On], the system goes on after an AC power loss. When set to [Last State], the system goes into either off or on state, whatever the system state was before the AC power loss. Configuration options: [Power Off] [Power On] [Last State]

Power On By PS/2 KB/MS [Disabled]

Allows you to enable or disable the PS/2 keyboard/mouse to generate a wake event. This feature requires an ATX power supply that provides at least 1A on the +5VSB lead. Configuration options: [Disabled] [Enabled]

Resume On Ring [Disabled]

Allows you to enable or disable RI to generate a wake event. Configuration options: [Disabled] [Enabled]

Resume On PCI Devices [Disabled]

When set to [Enabled], this parameter allows you to wake the system through a PCI LAN or modem card. This feature requires an ATX power supply that provides at least 1A on the +5VSB lead. Configuration options: [Disabled] [Enabled]

Resume On PCIE Devices [Disabled]

When set to [Enabled], this parameter allows you to wake the system through a PCI Express card. This feature requires an ATX power supply that provides at least 1A on the +5VSB lead. Configuration options: [Disabled] [Enabled]

Resume On RTC Alarm [Disabled]

Allows you to enable or disable RTC to generate a wake event. When this item is set to [Enabled], the items RTC Alarm Date, RTC Alarm Hour, RTC Alarm Minute, and RTC Alarm Second appear with set values. Configuration options: [Disabled] [Enabled]

2.5.5 Hardware Monitor

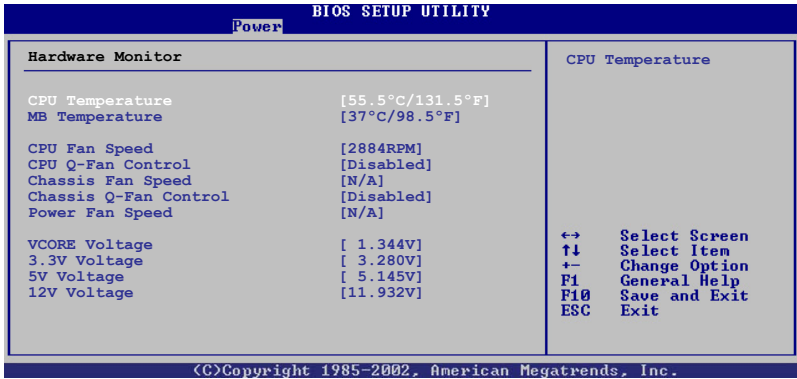

CPU Temperature [xxx°C/xxx°F]

The onboard hardware monitor automatically detects and displays the CPU temperatures. Select Ignored if you do not wish to display the detected temperatures.

MB Temperature [xxx°C/xxx°F]

The onboard hardware monitor automatically detects and displays the MB temperatures. Select Ignored if you do not wish to display the detected temperatures.

CPU Fan Speed (RPM) [xxxxRPM] or [N/A] or [Ignored]

The onboard hardware monitor automatically detects and displays the CPU fan speed in rotations per minute (RPM). If the fan is not connected to the motherboard, the field shows N/A. Select Ignored if you do not wish to display the detected speed.

CPU/Chassis Q-Fan Control [Disabled]

Allows you to enable or disable the CPU/Chassis Q-Fan control.
Configuration options: [Disabled] [Enabled]

Chassis/Power Fan Speed [xxxxRPM] or [N/A] or [Ignored]

The onboard hardware monitor automatically detects and displays the chassis/power fan speed in rotations per minute (RPM). If the fan is not connected to the chassis/power, the specific field shows N/A. Select Ignored if you do not wish to display the detected speed.

VCORE Voltage, 3.3V Voltage, 5V Voltage, 12V Voltage

The onboard hardware monitor automatically detects the voltage output through the onboard voltage regulators.

2.6 Boot menu

The Boot menu items allow you to change the system boot options. Select an item then press <Enter> to display the sub-menu.

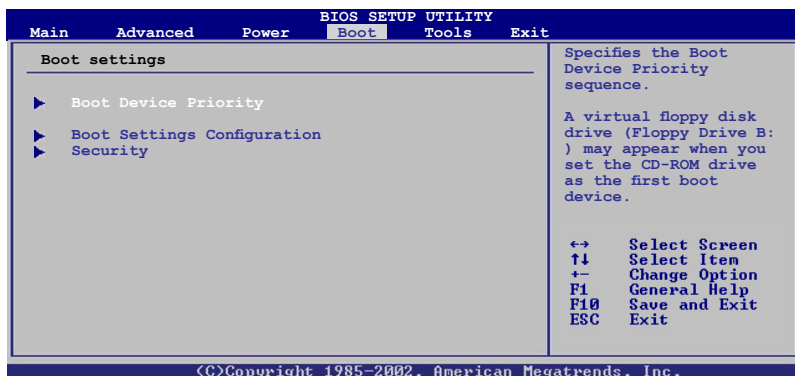

2.6.1 Boot Device Priority

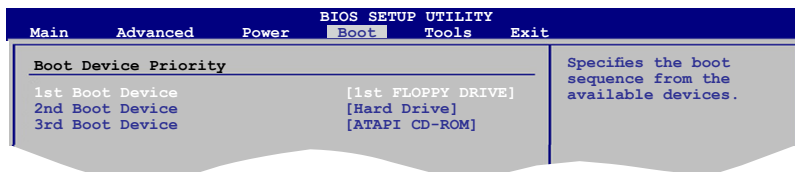

1st ~ xxth Boot Device [1st Floppy Drive]

These items specify the boot device priority sequence from the available devices. The number of device items that appears on the screen depends on the number of devices installed in the system. Configuration options: [xxxxx Drive] [Disabled]

2.6.2 Boot Settings Configuration

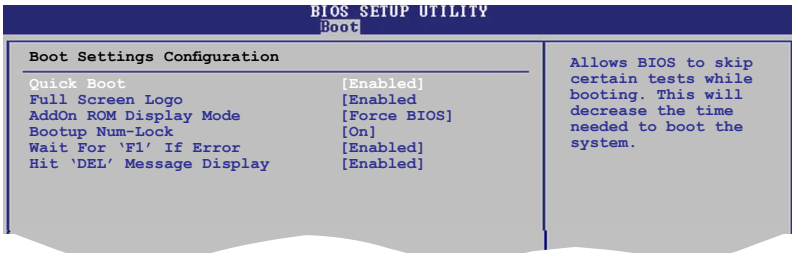

Quick Boot [Enabled]

Enabling this item allows the BIOS to skip some power on self tests (POST) while booting to decrease the time needed to boot the system. When set to [Disabled], BIOS performs all the POST items. Configuration options: [Disabled] [Enabled]

Full Screen Logo [Enabled]

This allows you to enable or disable the full screen logo display feature. Configuration options: [Disabled] [Enabled]



Set this item to [Enabled] to use the ASUS MyLogo2™ feature.

Add On ROM Display Mode [Force BIOS]

Sets the display mode for option ROM. Configuration options: [Force BIOS] [Keep Current]

Bootup Num-Lock [On]

Allows you to select the power-on state for the NumLock. Configuration options: [Off] [On]

Wait for 'F1' If Error [Enabled]

When set to [Enabled], the system waits for the F1 key to be pressed when error occurs. Configuration options: [Disabled] [Enabled]

Hit 'DEL' Message Display [Enabled]

When set to [Enabled], the system displays the message "Press DEL to run Setup" during POST. Configuration options: [Disabled] [Enabled]

2.6.3 Security

The Security menu items allow you to change the system security settings. Select an item then press <Enter> to display the configuration options.

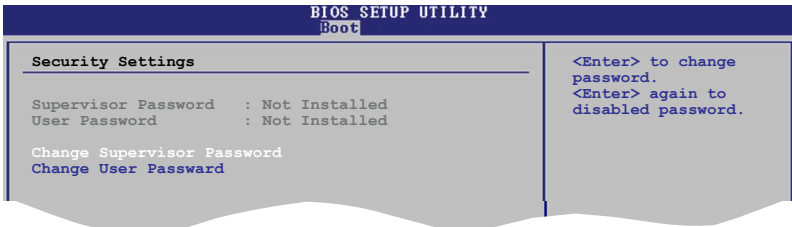

Change Supervisor Password

Select this item to set or change the supervisor password. The Supervisor Password item on top of the screen shows the default Not Installed. After you set a password, this item shows Installed.

To set a Supervisor Password:

1. Select the Change Supervisor Password item and press <Enter>.
2. From the password box, type a password composed of at least six letters and/or numbers, then press <Enter>.
3. Confirm the password when prompted.

The message "Password Installed" appears after you successfully set your password.

To change the supervisor password, follow the same steps as in setting a user password.

To clear the supervisor password, select the Change Supervisor Password then press <Enter>. The message "Password Uninstalled" appears.



If you forget your BIOS password, you can clear it by erasing the CMOS Real Time Clock (RTC) RAM. See section "1.9 Jumper" for information on how to erase the RTC RAM.

After you have set a supervisor password, the other items appear to allow you to change other security settings.

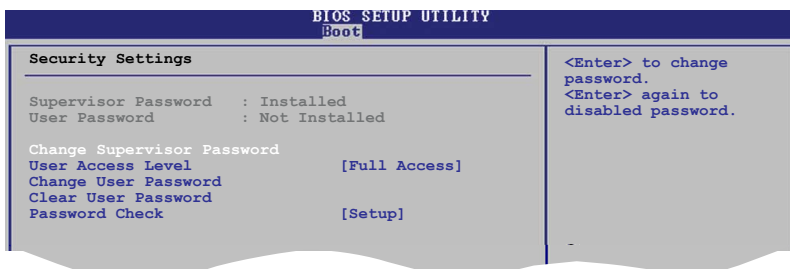

User Access Level [Full Access]

This item allows you to select the access restriction to the Setup items. Configuration options: [No Access] [View Only] [Limited] [Full Access]

No Access prevents user access to the Setup utility.

View Only allows access but does not allow change to any field.

Limited allows changes only to selected fields, such as Date and Time.

Full Access allows viewing and changing all the fields in the Setup utility.

Change User Password

Select this item to set or change the user password. The User Password item on top of the screen shows the default Not Installed. After you set a password, this item shows Installed.

To set a User Password:

1. Select the Change User Password item and press <Enter>.
2. On the password box that appears, type a password composed of at least six letters and/or numbers, then press <Enter>.
3. Confirm the password when prompted.

The message “Password Installed” appears after you set your password successfully.

To change the user password, follow the same steps as in setting a user password.

Clear User Password

Select this item to clear the user password.

Password Check [Setup]

When set to [Setup], BIOS checks for user password when accessing the Setup utility. When set to [Always], BIOS checks for user password both when accessing Setup and booting the system. Configuration options: [Setup] [Always]

2.7 Tools menu

The Tools menu items allow you to launch special functions. Select an item then press <Enter> to display the sub-menu.

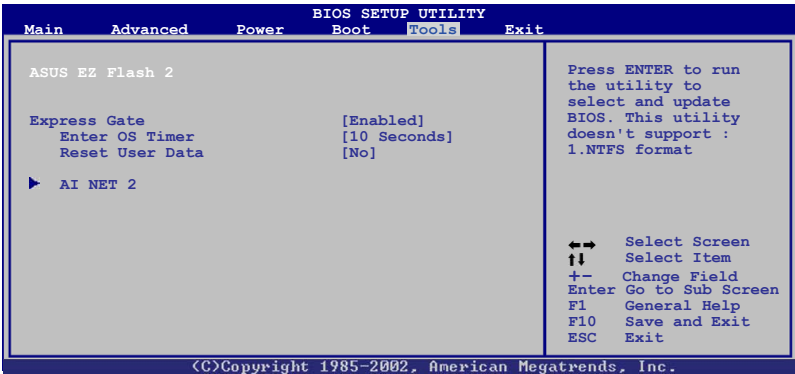

2.7.1 ASUS EZ Flash 2

Allows you to run ASUS EZ Flash 2. When you press <Enter>, a confirmation message appears. Use the left/right arrow key to select between [Yes] or [No], then press <Enter> to confirm your choice.

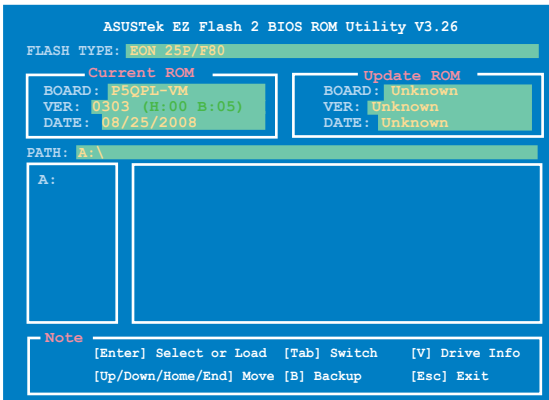

This function only supports FAT 32/16 format.

2.7.2 Express Gate [Enabled]

Allows you to enable or disable the ASUS Express Gate feature. The ASUS Express Gate feature is a unique instant-on environment that provides quick access to the Internet browser and Skype. Configuration options: [Disabled] [Enabled]

Enter OS Timer [10 Seconds]

Allows you to set the countdown duration that the system waits at the Express Gate's first screen before starting Windows or other installed OS. Choose [Prompt User] to stay at the first screen of Express Gate for user action.

Configuration options: [Prompt User] [1 Second] [3 Seconds] [5 Seconds] [10 Seconds] [15 Seconds] [20 Seconds] [30 Seconds]

Reset User Data [No]

Allows you to clear Express Gate's user data. Configuration options: [No] [Reset]

When setting this item to [Reset], the user data is cleared the next time you enter the Express Gate. User data includes the Express Gate's settings as well as any personal information stored by the web browser such as bookmarks, cookies, or browsing history. This is useful in the rare case where corrupt settings prevent the Express Gate environment from launching properly.



- The first time wizard runs again when you enter the Express Gate environment after clearing its settings.
- When changing any of the Express Gate settings, ensure to save the settings to the BIOS.

2.7.3 AI NET 2

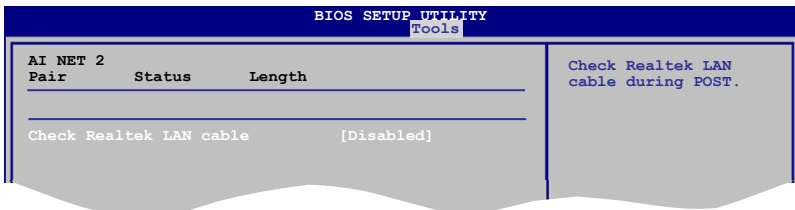

Check Realtek LAN cable [Disabled]

Allows you enable or disable checking Realtek LAN cable during POST.

Configuration options: [Disabled] [Enabled]

2.8 Exit menu

The Exit menu items allow you to load the optimal or failsafe default values for the BIOS items, and save or discard your changes to the BIOS items.

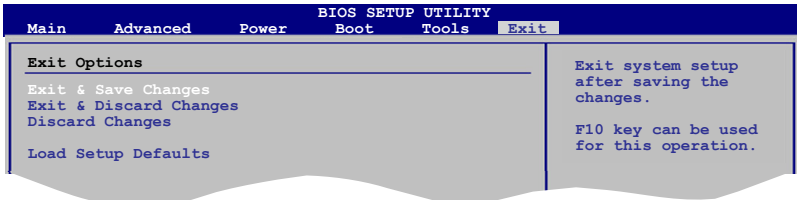

Pressing <Esc> does not immediately exit this menu. Select one of the options from this menu or <F10> from the legend bar to exit.

Exit & Save Changes

Once you are finished making your selections, choose this option from the Exit menu to ensure the values you selected are saved to the CMOS RAM. An onboard backup battery sustains the CMOS RAM so it stays on even when the PC is turned off. When you select this option, a confirmation window appears. Select **OK** to save changes and exit.



If you attempt to exit the Setup program without saving your changes, the program prompts you with a message asking if you want to save your changes before exiting. Press <Enter> to save the changes while exiting.

Exit & Discard Changes

Select this option only if you do not want to save the changes that you made to the Setup program. If you made changes to fields other than System Date, System Time, and Password, the BIOS asks for a confirmation before exiting.

Discard Changes

This option allows you to discard the selections you made and restore the previously saved values. After selecting this option, a confirmation appears. Select **OK** to discard any changes and load the previously saved values.

Load Setup Defaults

This option allows you to load the default values for each of the parameters on the Setup menus. When you select this option or if you press <F5>, a confirmation window appears. Select **OK** to load default values. Select **Exit & Save Changes** or make other changes before saving the values to the non-volatile RAM.

This chapter describes the contents of the support DVD that comes with the motherboard package.

3 Software support

3.1 Installing an operating system

This motherboard supports Windows® 32-bit XP/64-bit XP/32-bit Vista/64-bit Vista operating systems (OS). Always install the latest OS version and corresponding updates to maximize the features of your hardware.



- Motherboard settings and hardware options vary. Use the setup procedures presented in this chapter for reference only. Refer to your OS documentation for detailed information.
- Ensure that you install Windows® XP Service Pack2 or later versions before installing the drivers for better compatibility and system stability.

3.2 Support DVD information

The support DVD that came with the motherboard package contains the drivers, software applications, and utilities that you can install to avail all motherboard features.



The contents of the support DVD are subject to change at any time without notice. Visit the ASUS website(www.asus.com) for updates.

3.2.1 Running the support DVD

Place the support DVD to the optical drive. The DVD automatically displays the Drivers menu if Autorun is enabled in your computer.

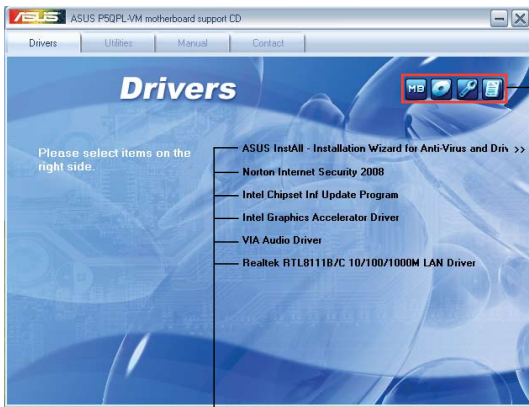

Click an icon to display support DVD/motherboard information

Click an item to install



If Autorun is NOT enabled in your computer, browse the contents of the support DVD to locate the file **ASSETUP.EXE** from the BIN folder. Double-click the **ASSETUP.EXE** to run the DVD.

3.2.2 Drivers menu

The drivers menu shows the available device drivers if the system detects installed devices. Install the necessary drivers to activate the devices.

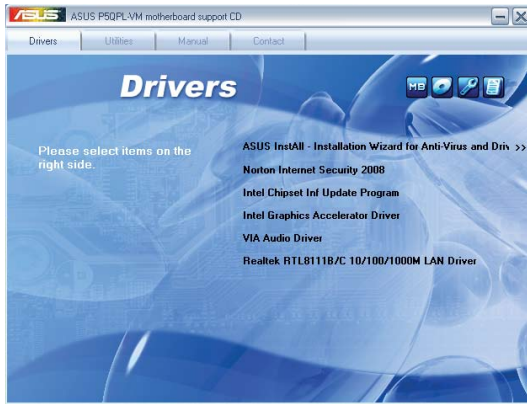

ASUS InstAll - Installation Wizard for Anti-Virus and Drivers Utility

Install anti-virus utility all of the drivers through the Installation Wizard.

Norton Internet Security 2008

Installs the Norton Internet Security 2008 to protect your PC from the latest online threats.

Intel Chipset Inf Update Program

Installs the Intel Chipset Inf Update Program.

Intel Graphics Accelerator Driver

Installs the Intel Graphics Accelerator driver.

VIA Audio Driver

Installs the VIA audio driver.

Realtek RTL8111B/C 10/100/1000M LAN Driver

Installs the Realtek RTL8111B/C 10/1000/1000M LAN driver.

3.2.3 Utilities menu

The Utilities menu shows the applications and other software that the motherboard supports.



Click to display the next page

ASUS InstAll - Installation Wizard for Utilities

Installs all of the utilities through the Installation Wizard.

ASUS PC Probe II

This smart utility monitors the fan speed, CPU temperature, and system voltages, and alerts you of any detected problems. This utility helps you keep your computer in healthy operating condition.

ASUS Update

The ASUS Update utility allows you to update the motherboard BIOS in Windows® environment. This utility requires an Internet connection either through a network or an Internet Service Provider (ISP).

Realtek Diagnostics Utility

Installs the Realtek Diagnostics Utility for cable test.

Adobe Acrobat Reader 8

Installs the Adobe Acrobat Reader that allows you to open, view and print documents in Portable Document Format (PDF).

Microsoft DirectX 9.0c

Installs the Microsoft® DirectX 9.0c driver. The Microsoft DirectX® 9.0c is a multimedia technology that enhances computer graphics and sound. DirectX® improves the multimedia features of your computer so you can enjoy watching TV and movies, capturing videos, or playing games in your computer. Visit the Microsoft website (www.microsoft.com) for updates.

Corel MediaOne Starter

Installs the Corel MediaOne Starter application to easily manage, edit share and protect your multimedia data.

CyberLink PowerBackup

Installs the CyberLink PowerBackup to back up and restore your data easily.

Ulead Burn Now

Installs the Ulead Burn. Now application for audio DVD, CD and data disc creation.

Ulead PhotoImpact 12 SE

Installs the PhotoImpact image editing software.

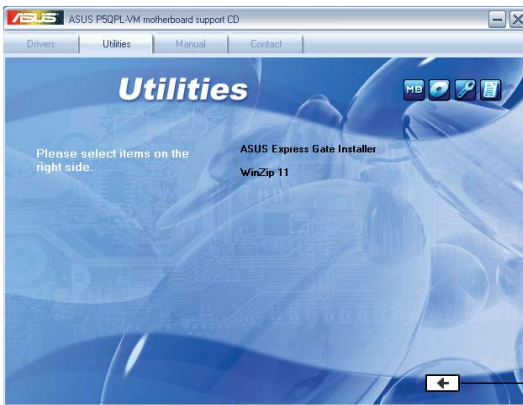

Click to return
to the previous
page

ASUS Express Gate Installer

Installs the ASUS Express Gate update application.

WinZip 11

Installs the Winzip utility for easy file-compression.

3.2.4 Manual menu

The Manuals menu contains a list of supplementary user manuals. Click an item to open the folder of the user manual.



Most user manual files are in Portable Document Format (PDF). Install the Adobe® Acrobat® Reader from the Utilities menu before opening a user manual file.



3.2.5 ASUS Contact information

Click the Contact tab to display the ASUS contact information. You can also find this information on the inside front cover of this user guide.

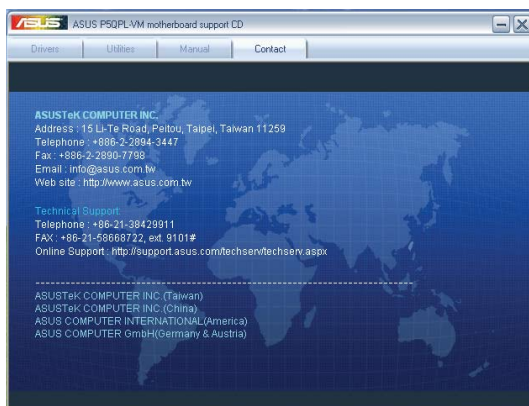

3.3 Software information

Most of the applications in the support DVD have wizards that will conveniently guide you through the installation. View the online help or readme file that comes with the software application for more information.

ASUS Express Gate

ASUS Express Gate is an instant-on environment that gives you quick access to the Internet. Within a few seconds of powering on your computer, you will be at the Express Gate menu where you can start the web browser, Skype, or other Express Gate softwares.

Installing ASUS Express Gate



- ASUS Express Gate supports installation on SATA HDDs in **IDE mode** only.
- ASUS Express Gate supports HDDs connected to **motherboard chipset-controlled onboard SATA ports** only. All onboard extended SATA ports and external SATA ports are NOT supported. See chapter 1 for the exact location of onboard SATA ports.
- ASUS Express Gate supports installation on USB HDDs and Flash drives, but the software performance may be slower than installed on SATA HDDs.

To install Express Gate on your computer

1. Place the support CD/DVD to the optical drive. The **Drivers** installation tab appears if your computer has enabled Autorun feature.
2. Click the **Utilities** tab, then click **ASUS Express Gate Installer**.
3. Select the language for installation and click **OK**.
4. The InstallShield Wizard for Express Gate appears. Click **Next** to continue.

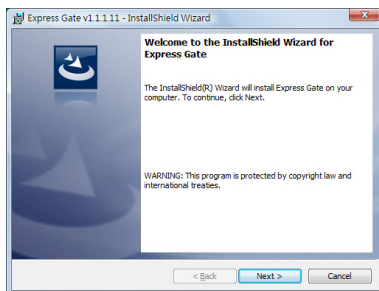
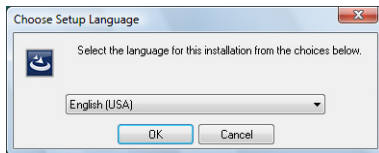

5. Select the target disk volume for you to install Express Gate. If you have multiple volumes and OS installed in your hard drive, it is recommended to install Express Gate in **Volume C**. Click **Next** to continue.
6. Follow the screen instructions to complete installation.

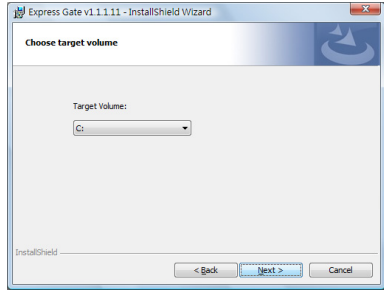

The First Screen

Express Gate’s first screen appears within a few seconds after you power on the computer. From here, you can immediately start the web browser or Skype.

You can also choose to continue booting normally (e.g. to your installed OS such as Windows), enter BIOS setup, or power off.



If you don’t make any selection, Express Gate will automatically exit and boot to your normal OS after a certain amount of time. The timer countdown is shown on-screen inside the “boot to OS” button. As you move the mouse or type a key, the countdown stops and the timer disappears, so you can take your time to make a selection.

The Express Gate Environment

The very first time you enter the Express Gate environment (by launching either web or Skype from the first screen), a first time wizard will guide you through basic Express Gate configurations. Basic configurations include language, date and time and screen resolution.



Once inside the Express Gate environment, click on the icons on the LaunchBar, by default at bottom of the screen, to launch or switch between softwares. You can re-arrange, re-size and move windows. Bring a window to the foreground by clicking within it or by clicking on its corresponding software icon. Re-size a window by dragging any of its four corners. Move a window by dragging its title bar.

Besides using the LaunchBar, you can also switch between softwares by pressing <Alt> +<Tab> on the keyboard. You can also right-click anywhere on the desktop to bring up a menu of softwares.

The red triangle on an software icon in the LaunchBar denotes that the software is already running. This means that you can switch to it without any delay. In the rare case where an software stops responding, right-click on its icon to force close it.

Knowing the Express Gate hot-keys

Here is a list of common-used hot-keys for Express Gate.

In the First Screen:

Key	Function
PAUSE/BREAK	Power-off
ESC	Continue to boot OS
DEL	Enter BIOS setup
F8	Enter Boot selection pop-up

In the Express Gate Environment:

Key	Function
<Alt> + <Tab>	Switch between softwares
<Ctrl> + <Alt> + 	Bring up Power-Off dialog box
<Ctrl> + <Alt> + <Print Screen>	Save screen snapshot as picture to file

Using the Configuration Panel

Use the configuration panel to change various Express Gate settings.

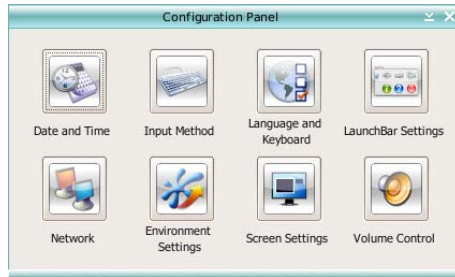

Click on an icon to open a particular configuration tool. The following tools are available:

- **Date and Time:** set current date and time as well as time zone.
- **Input Method:** choose your preferred input language and method.
- **Language and Keyboard:** choose your language and keyboard preferences.
- **LaunchBar Settings:** customize your LaunchBar (where it docks, whether it auto-hides, etc.)
- **Network:** Specify how your computer connects to the Internet. Enable all the network ports that you may use (LAN1, LAN2, and/or wireless [optional]). LAN1 and LAN2 refer to the two RJ-45 network ports on your computer.



-
- The number of the LAN ports may differ from motherboards.
 - You can connect the LAN cable to either port, and Express Gate will automatically use the connected port.
-

Also specify whether each port uses DHCP (most common) or static IP. For PPPoE and wireless (optional), set the login credentials (user name, password, SSID, etc.) as well.

- **Environment Settings:** This function allows you to clear the Express Gate settings, as well as any personal information stored by the web browser (Bookmarks, Cookies, History, etc.). The user data will be reset to the original default configuration.

After you click **Restore System**, a confirmation dialog box will open. If you click "Yes" in the confirmation dialog box, your system will immediately restart and then re-enter Express Gate to finish clearing the settings. This is also useful in the rare case where settings might become corrupted.



The first-time Wizard will run again when you enter the Express Gate environment after clearing its settings.

- **Screen Settings:** Choose the most optimal screen resolution for your display.
- **Volume Control:** Control the volume for your speaker output, microphone input, etc.

Using the LaunchBar

The LaunchBar has several system icons that show you various system statuses and let you configure individual Express Gate settings. The LaunchBar can be configured to auto-hide, if you want more screen space for the softwares. It can also be configured to dock on any of the four sides of the screen.



Starts the **Web Browser** for quick access to the World Wide Web.



Starts the **Photo Manager** album / organizer tool.



Starts the **Chat** instant messaging tool.



Start the **Skype** software, which lets you call other people on Skype for free, as well as offering affordable, high quality voice communications to phones all over the world.



Opens **Configuration Panel**, which lets you specify network settings and other preferences.

In the rare case that one of the above softwares stops responding, you can right-click on its icon and then select **Close** to force it to close.

The smaller icons on the right side of the LaunchBar are:



Click on this icon to open the **File Manager** window, which lets you conveniently access the files on a USB drive. If a USB device is detected, the icon contains a green arrow.



ASUS Express Gate supports file uploading from SATA HDDs, ODDs and USB drive and downloading to USB drives only.



Shows network status; click to configure network.



Shows mute status; click to change volume.



Click to choose input language and method as well as keyboard shortcuts (Ctrl-Space by default).



Click to change LaunchBar options (auto-hide, docking position, etc).



Click to show the “ASUS Utility” panel.



Click to show “About Express Gate ”.



Click to open Express Gate Help.



Click to bring up power options window to boot to OS, restart or power down. This window is also shown when you press Ctrl-Alt-Del on the keyboard.

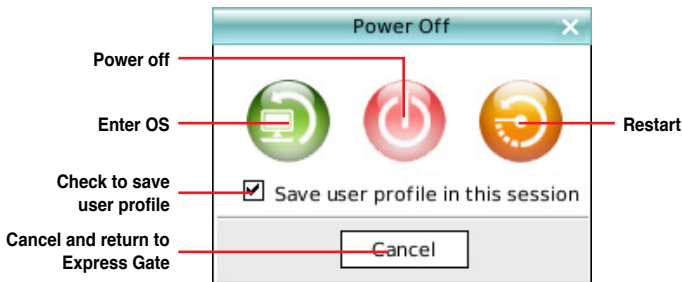

How Do I Get on to the Internet

If Internet doesn't seem to be working in the Express Gate environment, check the following:

1. Open the Configuration Panel.



Open Configuration Panel

2. Open Network.

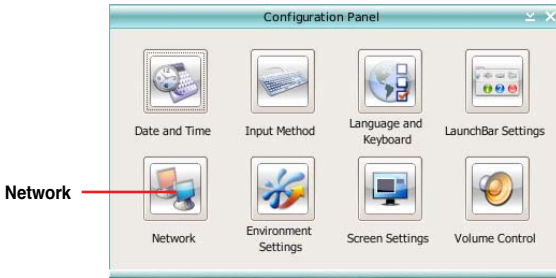

3. Make the proper network configurations.

Each network interface is enabled immediately when you check the box next to it.

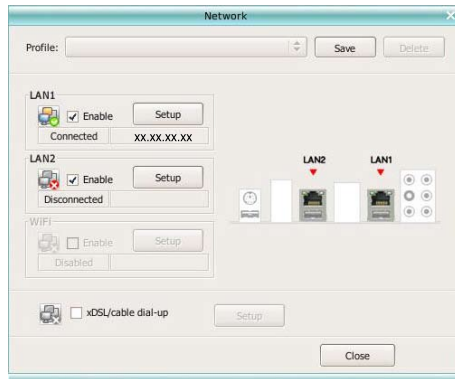

- If you use a network cable connected to a home router (which is then connected to your DSL/cable modem), enable both LAN1 and LAN2. Express Gate will automatically use whichever port (LAN1 or LAN2) is connected.



If you plug the network cable into a different port while Express Gate is running (e.g. move the cable from LAN1 to LAN2), you may need to press the “Refresh” button to detect the change.

- The most common scenario is for your computer to automatically obtain network settings (i.e. DHCP). If this is the case, you don't need to click **Setup** for any LAN port. If this is not the case, click **Setup** to configure the static IP settings manually.

- If you have wireless network, click **Setup** for the WiFi option. In the **WiFi** tab of the **Advanced Network Settings** box, enter the name of your wireless access point in the **SSID** field. If your wireless access point has security enabled, select the corresponding security algorithm from the drop-down list (e.g. WEP/AUTO) in the **Encryption Type** field, and enter the password. Click **OK** to enable WiFi and establish the wireless connection.
- If you use a network cable connected directly to your DSL/cable modem (no router in between), click **Setup** for xDSL/cable dial-up. This method is also referred to as PPPoE. Choose whether the DSL/cable modem is connected to your computer's LAN port. Then enter the username and password for your dial-up account. Click **OK** to enable xDSL/cable dial-up and establish the PPPoE connection. When PPPoE is enabled, the port it uses will automatically be unchecked and grayed out.

Using the Photo Manager

Express Gate provides a easy-to-use **Photo Manager** that allows you to view pictures stored in your hard drive or external storage devices (such as USB dongles, card readers, or optical disks). You can view pictures in thumbnail view; in an enlarged view individually; in a filename/data list view; or play them in a slideshow with background music and fancy transition effects. JPEG, GIF, BMP, and PNG formats are supported. Refer to the on-line Help for detailed software operation.

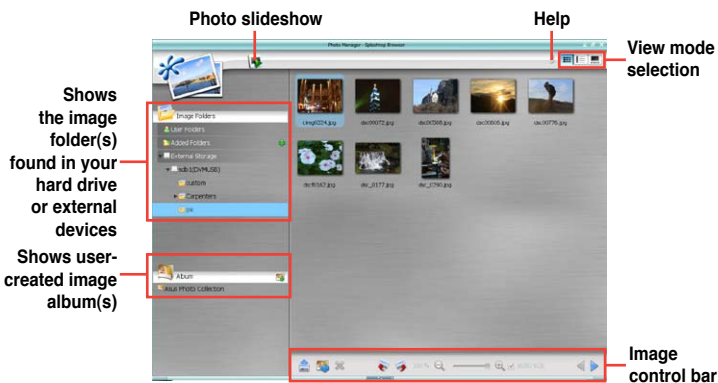

ASUS Express Gate supports HDDs connected to **motherboard chipset-controlled onboard SATA ports** only. All onboard extended SATA ports and external SATA ports are NOT supported.

Configuring Express Gate in BIOS Setup

Enter BIOS setup by pressing DEL key after powering on or by clicking on the BIOS setup icon on Express Gate's first screen. Express Gate configuration options are under the **Tools** menu. Refer to section **4.8.2 Express Gate** for details.

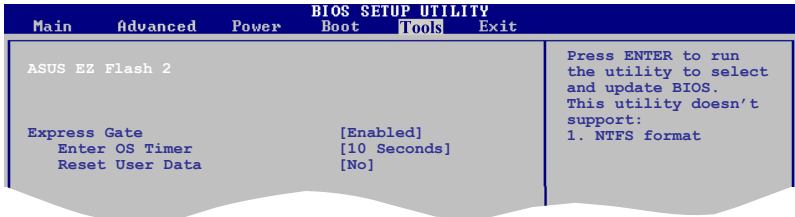

Updating Express Gate

You may update your existing Express Gate software to new versions. New versions of the Express Gate software will be released regularly, adding refinements or new applications. You can find original version of the software on the support DVD or download new versions from the ASUS support website.

To update Express Gate

1. Double-click the Express Gate setup file to start software update.
2. A software update confirmation dialog box appears. Click **Yes** to continue.
3. The InstallShield Wizard for Express Gate appears. Click **Next** to continue.
4. Follow the screen instructions to complete installation.

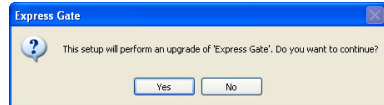

Repairing Express Gate

In case Express Gate cannot start normally, you can repair Express Gate by reinstalling the software or using the repairing utility.

To repair Express Gate

- Click **Start > All Programs > Express Gate > Express Gate Installer > Repair this software.**
OR
- Double click the Express Gate setup file, choose **Repair**, and click **Next** to continue.

