

P5N-EM HDMI

ASUS[®]

Motherboard

E3488

First Edition

March 2008

Copyright © 2008 ASUSTeK COMPUTER INC. All Rights Reserved.

No part of this manual, including the products and software described in it, may be reproduced, transmitted, transcribed, stored in a retrieval system, or translated into any language in any form or by any means, except documentation kept by the purchaser for backup purposes, without the express written permission of ASUSTeK COMPUTER INC. ("ASUS").

Product warranty or service will not be extended if: (1) the product is repaired, modified or altered, unless such repair, modification or alteration is authorized in writing by ASUS; or (2) the serial number of the product is defaced or missing.

ASUS PROVIDES THIS MANUAL "AS IS" WITHOUT WARRANTY OF ANY KIND, EITHER EXPRESS OR IMPLIED, INCLUDING BUT NOT LIMITED TO THE IMPLIED WARRANTIES OR CONDITIONS OF MERCHANTABILITY OR FITNESS FOR A PARTICULAR PURPOSE. IN NO EVENT SHALL ASUS, ITS DIRECTORS, OFFICERS, EMPLOYEES OR AGENTS BE LIABLE FOR ANY INDIRECT, SPECIAL, INCIDENTAL, OR CONSEQUENTIAL DAMAGES (INCLUDING DAMAGES FOR LOSS OF PROFITS, LOSS OF BUSINESS, LOSS OF USE OR DATA, INTERRUPTION OF BUSINESS AND THE LIKE), EVEN IF ASUS HAS BEEN ADVISED OF THE POSSIBILITY OF SUCH DAMAGES ARISING FROM ANY DEFECT OR ERROR IN THIS MANUAL OR PRODUCT.

SPECIFICATIONS AND INFORMATION CONTAINED IN THIS MANUAL ARE FURNISHED FOR INFORMATIONAL USE ONLY, AND ARE SUBJECT TO CHANGE AT ANY TIME WITHOUT NOTICE, AND SHOULD NOT BE CONSTRUED AS A COMMITMENT BY ASUS. ASUS ASSUMES NO RESPONSIBILITY OR LIABILITY FOR ANY ERRORS OR INACCURACIES THAT MAY APPEAR IN THIS MANUAL, INCLUDING THE PRODUCTS AND SOFTWARE DESCRIBED IN IT.

Products and corporate names appearing in this manual may or may not be registered trademarks or copyrights of their respective companies, and are used only for identification or explanation and to the owners' benefit, without intent to infringe.

Contents

Notices.....	vi
Safety information	vii
About this guide	viii
P5N-EM HDMI specifications summary.....	x
Chapter 1: Product introduction	
1.1 Welcome!	1-2
1.2 Package contents	1-2
1.3 Special features	1-2
1.3.1 Product highlights	1-2
1.3.2 ASUS Special features	1-4
1.4 Before you proceed	1-5
1.5 Motherboard overview	1-6
1.5.1 Placement direction	1-6
1.5.2 Screw holes	1-6
1.5.3 Motherboard layout.....	1-7
1.6 Central Processing Unit (CPU)	1-8
1.6.1 Installing the CPU	1-8
1.6.2 Installing the CPU heatsink and fan.....	1-11
1.6.3 Uninstalling the CPU heatsink and fan	1-13
1.7 System memory	1-15
1.7.1 Overview	1-15
1.7.2 Memory configurations.....	1-15
1.7.3 DDR2 Qualified Vendors List	1-16
1.7.4 Installing a DIMM	1-19
1.7.5 Removing a DIMM	1-19
1.8 Expansion slots	1-20
1.8.1 Installing an expansion card	1-20
1.8.2 Configuring an expansion card	1-20
1.8.3 Interrupt assignments	1-21
1.8.4 PCI slots.....	1-23
1.8.5 PCI Express x1 slot.....	1-23
1.8.6 PCI Express x16 Slot	1-23
1.9 Jumpers	1-24
1.10 Connectors	1-26
1.10.1 Rear panel connectors.....	1-26

Contents

1.10.2	Internal connectors	1-28
Chapter 2: BIOS setup		
2.1	Managing and updating your BIOS	2-2
2.1.1	ASUS Update utility	2-2
2.1.2	Creating a bootable floppy disk	2-5
2.1.3	ASUS EZ Flash 2 utility	2-6
2.1.4	Updating the BIOS	2-7
2.1.5	Saving the current BIOS file	2-9
2.1.6	ASUS CrashFree BIOS 2 utility	2-10
2.2	BIOS setup program	2-12
2.2.1	BIOS menu screen	2-13
2.2.2	Menu bar	2-13
2.2.3	Legend bar	2-14
2.2.4	Menu items	2-14
2.2.5	Sub-menu items	2-14
2.2.6	Configuration fields	2-14
2.2.7	Pop-up window	2-15
2.2.8	General help	2-15
2.3	Main menu	2-16
2.3.1	System Time	2-16
2.3.2	System Date	2-16
2.3.3	Legacy Diskette A	2-16
2.3.4	Primary IDE Master/Slave	2-17
2.3.5	SATA 1-4	2-19
2.3.6	HDD SMART Monitoring	2-20
2.3.7	Installed Memory	2-20
2.3.8	Usable Memory	2-20
2.4	Advanced menu	2-21
2.4.1	JumperFree	2-21
2.4.2	CPU Configuration	2-24
2.4.3	Chipset	2-25
2.4.4	PCI/PnP	2-25
2.4.5	Onboard Device Configuration	2-26
2.4.6	USB Configuration	2-29
2.5	Power menu	2-30

Contents

2.5.1	ACPI Suspend Type	2-30
2.5.2	ACPI APIC Support	2-30
2.5.3	APM Configuration.....	2-30
2.5.4	Hardware Monitor	2-33
2.6	Boot menu	2-34
2.6.1	Boot Device Priority	2-34
2.6.2	Removable Drives.....	2-34
2.6.3	Hard Disk Drives	2-35
2.6.4	Boot Settings Configuration	2-35
2.6.5	Security	2-37
2.7	Tools menu	2-38
	ASUS EZ Flash 2.....	2-38
2.8	Exit menu.....	2-39

Chapter 3: Software Support

3.1	Installing an operating system	3-2
3.2	Support CD information	3-2
3.2.1	Running the support CD	3-2
3.2.2	Drivers menu	3-3
3.2.3	Utilities menu	3-4
3.2.4	Make Disk menu	3-5
3.2.5	Manual menu	3-6
3.2.6	ASUS Contact information	3-7
3.2.7	Other information	3-7
3.3	Creating a RAID driver disk.....	3-9

Appendix: CPU features

A.1	Enhanced Intel SpeedStep® Technology (EIST)	A-2
A.1.1	System requirements	A-2
A.1.2	Using the EIST	A-2
A.2	Intel® Hyper-Threading Technology	A-4
	Using the Hyper-Threading Technology	A-4

Notices

Federal Communications Commission Statement

This device complies with Part 15 of the FCC Rules. Operation is subject to the following two conditions:

- This device may not cause harmful interference, and
- This device must accept any interference received including interference that may cause undesired operation.

This equipment has been tested and found to comply with the limits for a Class B digital device, pursuant to Part 15 of the FCC Rules. These limits are designed to provide reasonable protection against harmful interference in a residential installation. This equipment generates, uses and can radiate radio frequency energy and, if not installed and used in accordance with manufacturer's instructions, may cause harmful interference to radio communications. However, there is no guarantee that interference will not occur in a particular installation. If this equipment does cause harmful interference to radio or television reception, which can be determined by turning the equipment off and on, the user is encouraged to try to correct the interference by one or more of the following measures:

- Reorient or relocate the receiving antenna.
- Increase the separation between the equipment and receiver.
- Connect the equipment to an outlet on a circuit different from that to which the receiver is connected.
- Consult the dealer or an experienced radio/TV technician for help.



The use of shielded cables for connection of the monitor to the graphics card is required to assure compliance with FCC regulations. Changes or modifications to this unit not expressly approved by the party responsible for compliance could void the user's authority to operate this equipment.

Canadian Department of Communications Statement

This digital apparatus does not exceed the Class B limits for radio noise emissions from digital apparatus set out in the Radio Interference Regulations of the Canadian Department of Communications.

This class B digital apparatus complies with Canadian ICES-003.

Safety information

Electrical safety

- To prevent electrical shock hazard, disconnect the power cable from the electrical outlet before relocating the system.
- When adding or removing devices to or from the system, ensure that the power cables for the devices are unplugged before the signal cables are connected. If possible, disconnect all power cables from the existing system before you add a device.
- Before connecting or removing signal cables from the motherboard, ensure that all power cables are unplugged.
- Seek professional assistance before using an adapter or extension cord. These devices could interrupt the grounding circuit.
- Make sure that your power supply is set to the correct voltage in your area. If you are not sure about the voltage of the electrical outlet you are using, contact your local power company.
- If the power supply is broken, do not try to fix it by yourself. Contact a qualified service technician or your retailer.

Operation safety

- Before installing the motherboard and adding devices on it, carefully read all the manuals that came with the package.
- Before using the product, make sure all cables are correctly connected and the power cables are not damaged. If you detect any damage, contact your dealer immediately.
- To avoid short circuits, keep paper clips, screws, and staples away from connectors, slots, sockets and circuitry.
- Avoid dust, humidity, and temperature extremes. Do not place the product in any area where it may become wet.
- Place the product on a stable surface.
- If you encounter technical problems with the product, contact a qualified service technician or your retailer.



This symbol of the crossed out wheeled bin indicates that the product (electrical and electronic equipment, Mercury-containing button cell battery) should not be placed in municipal waste. Check local regulations for disposal of electronic products.

About this guide

This user guide contains the information you need when installing and configuring the motherboard.

How this guide is organized

This manual contains the following parts:

- **Chapter 1: Product introduction**
This chapter describes the features of the motherboard and the new technology it supports. It also lists the hardware setup procedures that you have to perform when installing system components. It includes description of the jumpers and connectors on the motherboard.
- **Chapter 2: BIOS setup**
This chapter tells how to change system settings through the BIOS Setup menus. Detailed descriptions of the BIOS parameters are also provided.
- **Chapter 3: Software support**
This chapter describes the contents of the support CD that comes with the motherboard package.
- **Appendix: CPU features**
This Appendix describes the CPU features that the motherboard supports.

Where to find more information

Refer to the following sources for additional information and for product and software updates.

1. **ASUS websites**
The ASUS website provides updated information on ASUS hardware and software products. Refer to the ASUS contact information.
2. **Optional documentation**
Your product package may include optional documentation, such as warranty flyers, that may have been added by your dealer. These documents are not part of the standard package.

Conventions used in this guide

To make sure that you perform certain tasks properly, take note of the following symbols used throughout this manual.



DANGER/WARNING: Information to prevent injury to yourself when trying to complete a task.



CAUTION: Information to prevent damage to the components when trying to complete a task.



IMPORTANT: Instructions that you **MUST** follow to complete a task.



NOTE: Tips and additional information to help you complete a task.

Typography

Bold text

Indicates a menu or an item to select.

Italics

Used to emphasize a word or a phrase.

<Key>

Keys enclosed in the less-than and greater-than sign means that you must press the enclosed key.

Example: <Enter> means that you must press the Enter or Return key.

<Key1>+<Key2>+<Key3>

If you must press two or more keys simultaneously, the key names are linked with a plus sign (+).

Example: <Ctrl>+<Alt>+<D>

Command

Means that you must type the command exactly as shown, then supply the required item or value enclosed in brackets.

Example: At the DOS prompt, type the command line:

```
format A: /S
```

P5N-EM HDMI specifications summary

CPU	LGA775 socket for Intel® Core™ 2 Quad / Core™ 2 Duo / Pentium® D / Pentium® 4 / Celeron® processors Compatible with Intel® 06 / 05B / 05A processors Supports Intel® next generation 45nm CPU Supports Enhanced Intel SpeedStep® Technology (EIST) Supports Intel® Hyper-Threading Technology *Refer to www.asus.com for Intel CPU support list
Chipset	North Bridge: NVIDIA GeForce 7100 / nForce 630i
Front Side Bus	1333 / 1066 / 800 / 533 MHz
Memory	Single-channel memory architecture 3 x 240-pin DIMM sockets support unbuffered non-ECC DDR2-1066 (overclocking) / 800 / 667 / 533 memory modules Supports up to 4 GB system memory
Expansion Slots	1 x PCI Express x16 slot 1 x PCI Express x1 slot 2 x PCI slots
Audio	Realtek ALC883 8-channel CODEC Supports S/PDIF out interface Supports jack-detect and Anti Pop Function Supports VISTA Premium OS
Storage	Southbridge: - 1 x Ultra DMA 133 - 4 x Serial ATA 3Gb/s devices - RAID 0, RAID 1, RAID 0+1, RAID 5, and JBOD configuration
LAN	Gb LAN
USB	Supports up to 10 USB 2.0 ports (6 ports at mid-board, 4 ports at rear panel)
ASUS Special Features	ASUS CrashFree BIOS 2 ASUS Q-Fan ASUS EZ Flash 2 ASUS MyLogo 2
Rear panel	1 x DVI port* 1 x HDMI port* 1 x LAN (RJ-45) port 4 x USB 2.0 / 1.1 ports 1 x VGA port 1 x PS/2 keyboard port (purple) 1 x PS/2 mouse port (green) 8-channel audio I/O ports Note*: Due to the chipset limitation, simultaneous output for DVI and HDMI is not supported.

(continued on the next page)

P5N-EM HDMI specifications summary

Internal connectors	1 x Floppy disk drive connector 1 x CD audio in connector 1 x 24-pin ATX power connector 1 x 4-pin ATX 12 V power connector 3 x USB connectors for additional six USB 2.0 ports 1 x S/PDIF out connector 1 x Chassis intrusion connector 1 x Front panel audio connector 1 x COM connector 1 x LPT connector 1 x CPU Fan connector 1 x Chassis fan connector 1 x Speaker connector System panel connector
VGA	GeForce 7100 GPU supports maximum resolution of 1920 x1440 bpp (@ 75Hz)
BIOS features	8 MB Flash ROM, Award BIOS, PnP, DMI2.0, WfM2.0, ACPI v2.0a, SMBIOS 2.5
Power Requirement	ATX power supply (with 24-pin and 4-pin 12V plugs) ATX 12V 2.0 compliant
Manageability	WOL, PXE, RPL, WOR by Ring, PME Wake UP
Support CD contents	Drivers ASUS PC Probe II ASUS Update Anti-virus software
Form factor	MicroATX Form Factor: 9.6 in x 8.2 in (24.5 cm x 20.8 cm)

*Specifications are subject to change without notice.



This chapter describes the motherboard features and the new technologies it supports.

1 Product introduction

1.1 Welcome!

Thank you for buying an ASUS® P5N-EM HDMI motherboard!

The motherboard delivers a host of new features and latest technologies, making it another standout in the long line of ASUS quality motherboards!

Before you start installing the motherboard, and hardware devices on it, check the items in your package with the list below.

1.2 Package contents

Check your motherboard package for the following items.

Motherboard	ASUS P5N-EM HDMI motherboard
Cables	1 x Serial ATA cable 1 x Serial ATA power cable 1 x Ultra DMA 133 / 100 / 66 / 33 cable 1 x Floppy disk drive cable
Accessories	I/O shield
Application CDs	ASUS motherboard support CD
Documentation	User guide



If any of the above items is damaged or missing, contact your retailer.

1.3 Special features

1.3.1 Product highlights

Green ASUS



This motherboard and its packaging comply with the European Union's Restriction on the use of Hazardous Substances (RoHS). This is in line with the ASUS vision of creating environment-friendly and recyclable products/packaging to safeguard consumers' health while minimizing the impact on the environment.

LGA775 Intel® Quad-core Processor Ready



This motherboard supports the latest powerful and energy efficient processors from Intel. Intel® Quad-core is based on the Intel Core Microarchitecture process technology that allows users to step up to new levels of gaming experience and multi-tasking performance.

Combined with 1333 / 1066 / 800 of front side bus (FSB), this motherboard guarantees enhanced user experience in the digital home and office.

Intel® Core™2 Processor Ready



This motherboard supports the latest Intel® Core™2 processor in the LGA775 package. With the new Intel® Core™ microarchitecture technology and 1333 / 1066 / 800 MHz FSB, Intel® Core™2 processor is designed to provide powerful and energy efficient performance.

DDR2 memory support



The motherboard supports DDR2 memory that features data transfer rates of 533 / 667 / 800 / 1066 (overclocking) MHz to meet the higher bandwidth requirements of the latest 3D graphics, multimedia, and Internet applications.

Serial ATA 3 Gb/s technology



This motherboard supports the next-generation hard drives based on the Serial ATA (SATA) 3 Gb/s storage specification, delivering enhanced scalability and doubling the bus bandwidth for high-speed data retrieval and saves. Easily backup photos, videos and other entertainment contents to external devices. See page 1-28 for details.

S/PDIF digital sound ready

The motherboard supports the SONY-PHILIPS Digital Interface function (S/PDIF-out) through the S/PDIF interface at mid-board. It allows to transfer digital audio without converting to analog format and keeps the best signal quality. See page 1-30 for details.

8-Channel High Definition Audio



Enjoy high-end sound quality on your PC! The onboard 8-channel HD audio (High Definition Audio, previously codenamed Azalia) CODEC enables high-quality 192KHz / 24-bit audio output, jack-detect feature.

HDMI™ Interface



High-Definiton Multimedia Interface (HDMI) is the first and only industry-supported, uncompressed, all digital audio and video interface via a single cable and is HDCP compliant allowing playback of HD DVD, Blu-ray Disc and other protected content.

DVI Interface



DVI (Digital Visual Interface) provides high visual quality of digital display devices such as LCD monitor. The interface of this motherboard is HDCP compliant, allowing playback of HD DVD, Blu-ray Disc and other protected content.

Dual VGA Output



This motherboard supports Dual-VGA output (RGB & HDMI / DVI). HDMI / DVI interface is compliant with HDCP.

1.3.2 ASUS Special features

ASUS Q-Fan technology



The ASUS Q-Fan technology smartly adjusts the fan speeds according to the system loading to ensure quiet, cool, and efficient operation. See page 2-33 for details.

ASUS MyLogo2™



This feature allows you to convert your favorite photo into a 256-color boot logo for a more colorful and vivid image on your screen. See page 2-36 for details.

ASUS EZ Flash 2



EZ Flash 2 is a user-friendly BIOS update utility. Simply press the predefined hotkey to launch the utility and update the BIOS without entering the OS. Update your BIOS easily without preparing a bootable diskette or using an OS-based flash utility. See page 2-6 for details.

ASUS CrashFree BIOS 2



This feature allows you to restore the original BIOS data from the support CD in case when the BIOS codes and data are corrupted. This protection eliminates the need to buy a replacement BIOS chip. See page 2-10 for details.

1.4 Before you proceed

Take note of the following precautions before you install motherboard components or change any motherboard settings.



- Unplug the power cord from the wall socket before touching any component.
- Use a grounded wrist strap or touch a safely grounded object or to a metal object, such as the power supply case, before handling components to avoid damaging them due to static electricity
- Hold components by the edges to avoid touching the ICs on them.
- Whenever you uninstall any component, place it on a grounded antistatic pad or in the bag that came with the component.
- Before you install or remove any component, ensure that the ATX power supply is switched off or the power cord is detached from the power supply. Failure to do so may cause severe damage to the motherboard, peripherals, and/or components.

Onboard LED

The motherboard comes with a standby power LED that lights up to indicate that the system is ON, in sleep mode, or in soft-off mode. This is a reminder that you should shut down the system and unplug the power cable before removing or plugging in any motherboard component. The illustration below shows the location of the onboard LED.

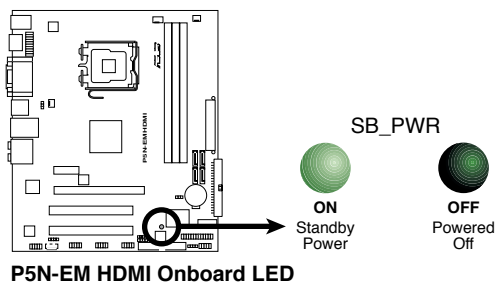

1.5 Motherboard overview

Before you install the motherboard, study the configuration of your chassis to ensure that the motherboard fits into it.



Ensure to unplug the power cord before installing or removing the motherboard. Failure to do so can cause you physical injury and damage motherboard components.

1.5.1 Placement direction

When installing the motherboard, ensure that you place it into the chassis in the correct orientation. The edge with external ports goes to the rear part of the chassis as indicated in the image below.

1.5.2 Screw holes

Place six (6) screws into the holes indicated by circles to secure the motherboard to the chassis.



Do not overtighten the screws! Doing so can damage the motherboard.

Place this side towards
the rear of the chassis

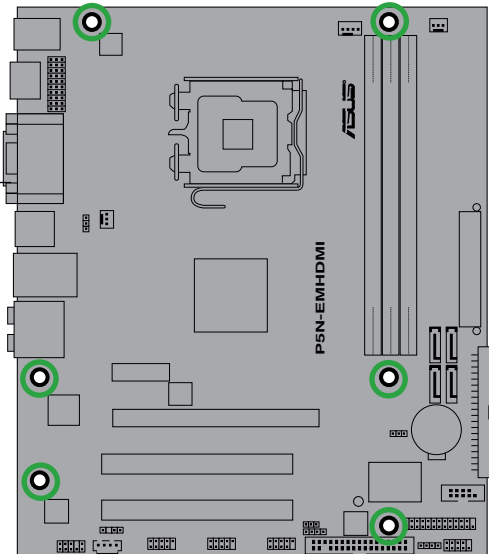

1.5.3 Motherboard layout

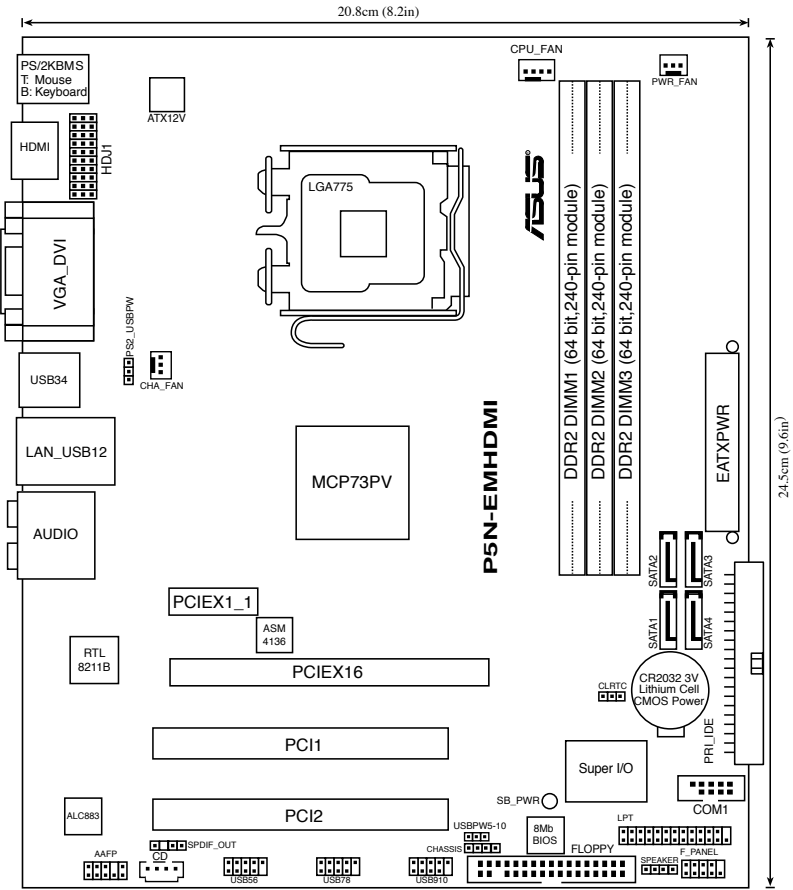

1.6 Central Processing Unit (CPU)

The motherboard comes with a surface mount LGA775 socket designed for the Core™2 Quad / Core™2 Duo / Pentium® D / Pentium® 4 and Celeron® processors.



- Your boxed Intel® Core™2 Quad / Core™2 Duo / Pentium® D / Pentium® 4 or Celeron® LGA775 processor package should come with installation instructions for the CPU, fan and heatsink assembly. If the instructions in this section do not match the CPU documentation, follow the latter.
- Upon purchase of the motherboard, ensure that the PnP cap is on the socket and the socket pins are not bent. Contact your retailer immediately if the PnP cap is missing, or if you see any damage to the PnP cap/socket pins/motherboard components. ASUS will shoulder the cost of repair only if the damage is shipment/transit-related.
- Keep the cap after installing the motherboard. ASUS will process Return Merchandise Authorization (RMA) requests only if the motherboard comes with the cap on the LGA775 socket.
- The product warranty does not cover damage to the socket pins resulting from incorrect CPU installation/removal, or misplacement/loss/incorrect removal of the PnP cap.

1.6.1 Installing the CPU

To install a CPU:

1. Locate the CPU socket on the motherboard.

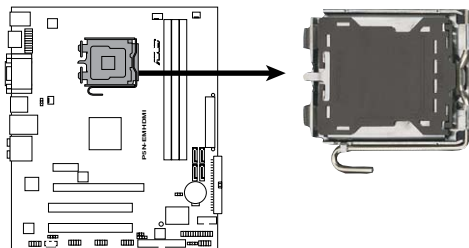

P5N-EM HDMI CPU Socket 775



Before installing the CPU, ensure that the socket box is facing towards you and the load lever is on your left.

2. Press the load lever with your thumb (A) and move it to the left (B) until it is released from the retention tab.

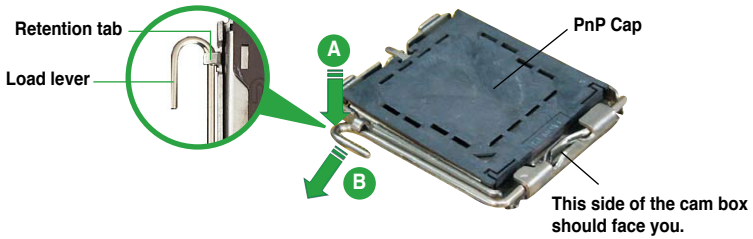

To prevent damage to the socket pins, do not remove the PnP cap unless you are installing a CPU.

3. Lift the load lever in the direction of the arrow to a 135° angle.

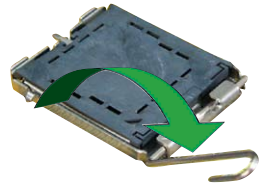

4. Lift the load plate with your thumb and forefinger to a 100° angle (A), then push the PnP cap from the load plate window to remove (B).

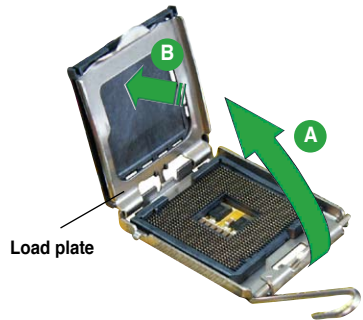

5. Position the CPU over the socket, making sure that the gold triangle is on the bottom-left corner of the socket. The socket alignment key should fit into the CPU notch.

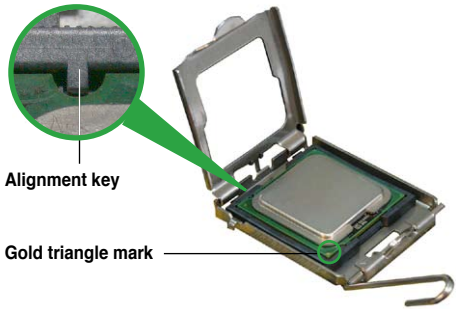

6. Close the load plate (A), then push the load lever (B) until it snaps into the retention tab.

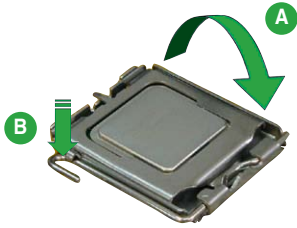

The CPU fits in only one correct orientation. **DO NOT** force the CPU into the socket to prevent bending the connectors on the socket and damaging the CPU!



The motherboard supports Intel® LGA775 processors with the Enhanced Intel SpeedStep® Technology (EIST), and Hyper-Threading Technology.

1.6.2 Installing the CPU heatsink and fan

The Intel® Core™ 2 Quad / Core™ 2 Duo / Pentium D / Pentium® 4 / Celeron® processor require a specially designed heatsink and fan assembly to ensure optimum thermal condition and performance.



- Install the motherboard to the chassis before you install the CPU fan and heatsink assembly
- When you buy a boxed Intel® Core™ 2 Quad / Core™ 2 Duo / Pentium D / Pentium® 4 / Celeron® processor, the package includes the CPU fan and heatsink assembly. If you buy a CPU separately, ensure that you use only Intel®-certified multi-directional heatsink and fan.
- Your Intel® Core™ 2 Quad / Core™ 2 Duo / Pentium D / Pentium® 4 / Celeron® LGA775 heatsink and fan assembly comes in a push-pin design and requires no tool to install.



If you purchased a separate CPU heatsink and fan assembly, ensure that a Thermal Interface Material is properly applied to the CPU heatsink or CPU before you install the heatsink and fan assembly.

To install the CPU heatsink and fan:

1. Place the heatsink on top of the installed CPU, making sure that the four fasteners match the holes on the motherboard.

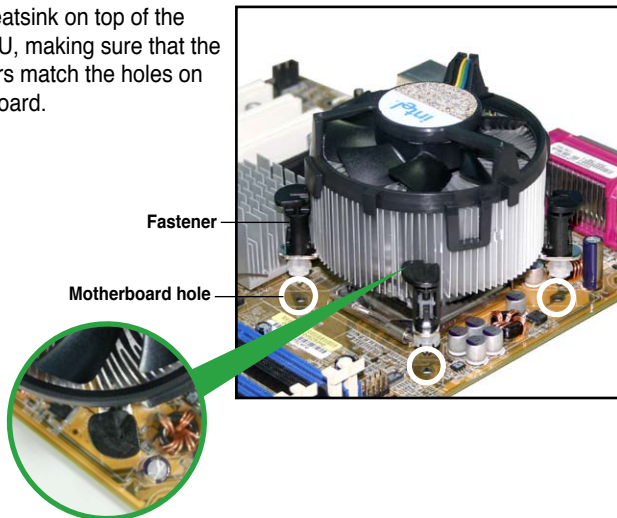

Ensure that each fastener is oriented as shown, with the narrow groove directed outward.

2. Push down two fasteners at a time in a diagonal sequence to secure the heatsink and fan assembly in place.

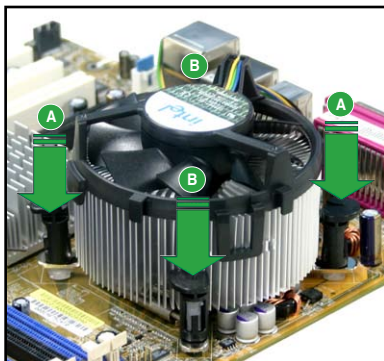
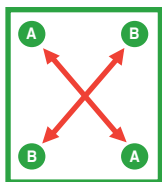

3. When the fan and heatsink assembly is in place, connect the CPU fan cable to the connector on the motherboard labeled CPU_FAN.

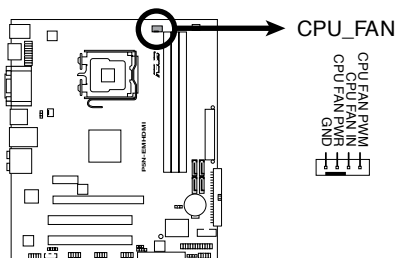

P5N-EM HDMI CPU Fan Connector



- Do not forget to connect the CPU fan connector! Hardware monitoring errors can occur if you fail to plug this connector.
- We recommend you to install the chassis fan for better thermal state.

1.6.3 Uninstalling the CPU heatsink and fan

To uninstall the CPU heatsink and fan:

1. Disconnect the CPU fan cable from the connector on the motherboard.
2. Rotate each fastener counterclockwise.



3. Pull up two fasteners at a time in a diagonal sequence to disengage the heatsink and fan assembly from the motherboard.

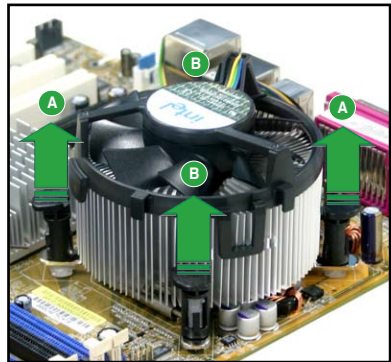
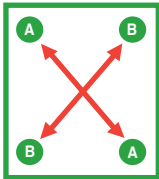

4. Remove the heatsink and fan assembly from the motherboard.

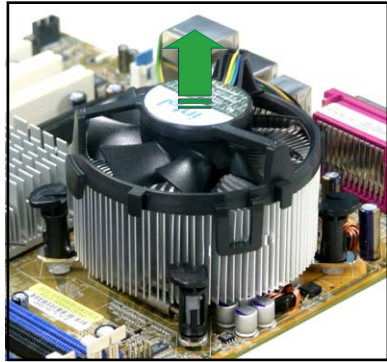

5. Rotate each fastener clockwise to reset the orientation.

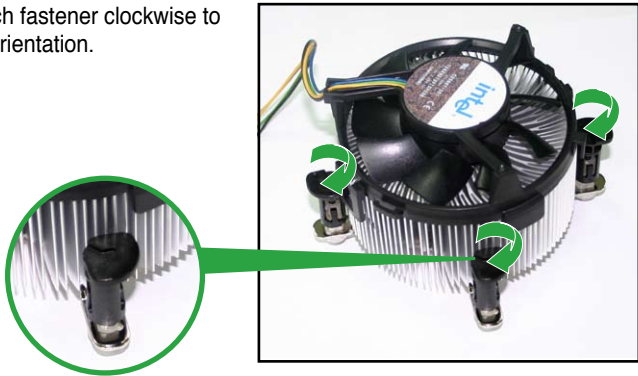

Narrow end of the groove



The narrow end of the groove should point outward after resetting. (The photo shows the groove shaded for emphasis.)



1.7 System memory

1.7.1 Overview

The motherboard comes with three Double Data Rate 2 (DDR2) Dual Inline Memory Modules (DIMM) sockets.

A DDR2 module has the same physical dimensions as a DDR DIMM but has a 240-pin footprint compared to the 184-pin DDR DIMM. DDR2 DIMMs are notched differently to prevent installation on a DDR DIMM socket.

The figure illustrates the location of the DDR2 DIMM sockets:

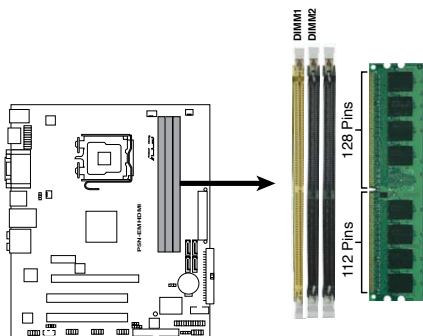

P5N-EM HDMI 240-pin DDR2 DIMM Sockets

Sockets	Color
DIMM1	Yellow
DIMM2, and DIMM3	Black

1.7.2 Memory configurations

You may install 256 MB, 512 MB, 1 GB and 2 GB unbuffered non-ECC DDR2 DIMMs into the DIMM sockets.



- The yellow socket supports maximum 2G memory modules.
- The total size supported by the two black sockets is 2G. You may install one double-sided memory module into either the black socket, or two single-sided memory modules into both black sockets.
- When installing two double-sided memory modules, you can only install them into DIMM1 and DIMM2, or DIMM1 and DIMM3.
- When installing only one single-sided memory module, do not install it into DIMM3; when installing two single-sided memory modules, do not install them into DIMM1 and DIMM3 at the same time.
- Always install DIMMs with the same CAS latency. For optimum compatibility, it is recommended that you obtain memory modules from the same vendor. Refer to the DDR2 Qualified Vendors List at the ASUS website (www.asus.com) for details.

1.7.3 DDR2 Qualified Vendors List

The following table lists the memory modules that have been tested and qualified for use with this motherboard. Visit the ASUS website (www.asus.com) for the latest DDR2 DIMM modules for this motherboard.

DDR2 533 Qualified Vendors List

Size	Vendor	Part No.	CL	Chip Brand	SS/DS	Chip No.	DIMM support		
							A*	B*	C*
256MB	Kingston	KVR533D2N4/256	N/A	Elpida	SS	E5116AF-5C-E	-	-	-
512MB	Kingston	KVR533D2N4/512	N/A	Infineon	SS	HYB18T512800AF3733336550	-	-	-
1G	Kingston	KVR533D2N4/1G	N/A	Hynix	DS	HY5PS12821EFP-Y5	-	-	-
256MB	Samsung	M378T3253FG0-CD5	N/A	Samsung	SS	K4T56083QF-GCD5	-	-	-
512MB	Samsung	M378T6553BG0-CD5	4	Samsung	SS	K4T51083QB-GCD5	-	-	-
256MB	HY	HYMP532U64CP6-C4 AB	4	Hynix	SS	HY5PS121621CFP-C4	-	-	-
512MB	HY	HYMP564U64BP8-C4 AB	4	Hynix	SS	HY5PS12821BFP-C4	-	-	-
1G	HY	HYMP512U64CP8-C4 AB	4	Hynix	DS	HY5PS12821CFP-C4	-	-	-
512MB	Micron	MT 16HTF6464AG-53EB2	4	Micron	DS	D9BOM	-	-	-
1G	Micron	MT 16HTF12864AY-53EA1	4	Micron	DS	D9CRZ	-	-	-
512MB	Corsair	VS512MB533D2	N/A	Corsair	DS	MIII0052532M8CEC	-	-	-
1G	Corsair	VS1GB533D2	N/A	Corsair	DS	64M8CFEGQIB0900718	-	-	-
512MB	Elpida	EBE51UD8ABFA-5C-E	N/A	Elpida	SS	E5108AB-5C-E	-	-	-
512MB	Kingmax	KLBC28F-A8KB4	N/A	Kingmax	SS	KKEA88B4IAK-37	-	-	-
512MB	ADATA	M2OAD2G3H31661B52	N/A	ADATA	SS	AD29608A8A-37DG20719	-	-	-
2G	ADATA	M20AD2H3J41701B53	N/A	ADATA	DS	AD20908A8A-37DG30721	-	-	-

DDR2 667 Qualified Vendors List

Size	Vendor	Part No.	CL	Chip Brand	SS/DS	Chip No.	DIMM support		
							A*	B*	C*
256MB	Kingston	KVR667D2N5/256	N/A	Infineon	SS	HYB18T256800AF3SW65 33154	-	-	-
512MB	Kingston	KVR667D2N5/512	N/A	Hynix	SS	HY5PS12821EFP-Y5	-	-	-
1G	Kingston	KVR667D2N5/1G	N/A	Hynix	DS	HY5PS12821EFP-Y5	-	-	-
2G	Kingston	KVR667D2N5/2G	N/A	Micron	DS	7RE22 D9HNL	-	-	-
512MB	Samsung	KR M378T6553CZ0-CE6	N/A	Samsung	SS	K4T51083QC	-	-	-
512MB	Samsung	KR M378T6453FZ0-CE6	N/A	Samsung	DS	K4T56083QF-ZCE6	-	-	-
512MB	Samsung	M378T6553CZ3-CE6	N/A	Samsung	SS	K4T51083QC-ZCE6	-	-	-
1G	Samsung	M378T2953CZ3-CE6	N/A	Samsung	DS	K4T51083QC-ZCE6	-	-	-
1G	Samsung	KR M378T2953CZ0-CE6	N/A	Samsung	DS	K4T51083QC-ZCE6	-	-	-
512MB	Qimonda	HYS64T64000EU-3S-B2	5	Qimonda	SS	HYB18T512B00B2F3SFSS28171	-	-	-
1G	Qimonda	HYS64T128020EU-3S-B2	5	Qimonda	DS	HYB18T512B00B2F3SFSS28171	-	-	-
2G	Qimonda	HYS64T256020EU-3S-B	5	Qimonda	DS	HTB18T1G800BF-3S3VV10907	-	-	-
512MB	Corsair	VS512MB667D2	N/A	Corsair	SS	64M8CFEGPS0900647	-	-	-
1G	Corsair	VS1GB667D2	N/A	Corsair	DS	MID095D62864M8CEC	-	-	-
1G	Corsair	XMS2-5400	4	Corsair	DS	Heat-Sink Package	-	-	-

DDR2 667 Qualified Vendors List

Size	Vendor	Part No.	CL	Chip Brand	SS/ DS	Chip No.	DIMM support		
							A*	B*	C*
1G	Micron	MT8HTF12864AY-667E1	5	Micron	SS	D9HNL 7ZE17	.	.	.
256MB	HY	HYMP532U64CP6-Y5 AB	5	Hynix	SS	HY5PS121621CFP-Y5	.	.	.
512MB	HY	HYMP564U64AP8-Y4 AA	N/A	Hynix	SS	HY5PS12821AFP-Y4	.	.	.
512MB	HY	HYMP564U64AP8-Y5 AA	N/A	Hynix	SS	HY5PS12821AFP-Y5	.	.	.
1G	HY	HYMP512U64AP8-Y5 AB	N/A	Hynix	DS	HY5PS12821AFP-Y5	.	.	.
1G	HY	HYMP512U64CP8-Y5 AB	5	Hynix	DS	HY5PS12521CFP-Y5	.	.	.
512MB	Kingmax	KLCC28F-A8KB5	N/A	Kingmax	SS	KKEA88B4LAUG-29DX	.	.	.
1G	Kingmax	KLCD48F-A8KB5	N/A	Kingmax	DS	KKEA88B4LAUG-29DX	.	.	.
512MB	Apacer	78.91092.420	N/A	Elpida	SS	E5108AE-6E-E	.	.	.
512MB	Apacer	AU512E667C5KBGC	5	Apacer	SS	AM4B5708MJS7E0627B	.	.	.
512MB	Apacer	AU512E667C5KBGC	5	Apacer	SS	AM4B5708GQS7E06332F	.	.	.
512MB	Apacer	AU512E667C5KBGC	5	Apacer	SS	AM4B5708GQS7E0632C	.	.	.
512MB	Apacer	78.91G92.9K5	5	Apacer	SS	AM4B5708JQS7E0751C	.	.	.
1G	Apacer	AU01GE667C5KBGC	N/A	Apacer	DS	AM4B5708GQS7E0636B	.	.	.
1G	Apacer	AU01GE667C5KBGC	5	Apacer	DS	AM4B5708MJS7E0627B	.	.	.
512MB	ADATA	M20EL5G3H3160B1COZ	N/A	Elpida	SS	E5108AE-6E-E	.	.	.
512MB	ADATA	M20AD5G3H3166H1C52	N/A	ADATA	SS	AD29608A8A-3EG20648	.	.	.
512MB	ADATA	M20AD5G3H3166H1C52	N/A	ADATA	SS	AD29608A8A-3EG20718	.	.	.
1G	ADATA	M20AD5G3H3176H1C52	N/A	ADATA	DS	AD29608A8A-3EG20645	.	.	.
2G	ADATA	M20AD5H3J4170H1C53	N/A	ADATA	DS	AD20908A8A-3EG 30724	.	.	.
512MB	VDATA	M2GVD5G3H31A4H1C52	N/A	VDATA	SS	VD29608A8A-3EC20615	.	.	.
512MB	VDATA	M2GVD5G3H166H1C52	N/A	VDATA	SS	VD29608A8A-3EG20637	.	.	.
1G	VDATA	M2GVD5G3H41P6H1C52	N/A	VDATA	DS	VD29608A8A-3EG20627	.	.	.
1G	VDATA	M2GVD5G3H41C4H1C52	N/A	VDATA	DS	VD29608A8A-3EC20620	.	.	.
1G	VDATA	M2GVD5G3H4176H1C52	N/A	VDATA	DS	VD29608A8A-3EG20641	.	.	.
512MB	PSC	AL6E8E63B-6E1K	5	PSC	SS	A3R12E3GEF637BLC5N	.	.	.
512MB	PSC	AL6E8E63J-6E1	5	PSC	SS	A3R12E3JFF717B9A00	.	.	.
1G	PSC	AL7E8E63B-6E1K	5	PSC	DS	A3R12E3GEF637BLC5N	.	.	.
1G	PSC	AL7E8E63J-6E1	5	PSC	DS	A3R12E3JFF717B9A01	.	.	.
1G	PSC	AL7E8F73C-6E1	5	PSC	SS	A3R1GE3CFF734MAA0J	.	.	.
2G	PSC	AL8E8F73C-6E1	5	PSC	DS	A3R1GE3CFF733MAA00	.	.	.
256MB	Nanya	NT256T64UH4A1FY-3C	N/A	Nanya	SS	NT5TU32M16AG-3C	.	.	.
512MB	Nanya	NT512T64U88A1BY-3C	N/A	Nanya	SS	NT5TU64M8AE-3C	.	.	.
1G	Super Talent	T667UB1GV	5	Super Talent	DS	PG 64M8-800 0750	.	.	.
1G	Kingtiger	E0736001024667	N/A	Kingtiger	DS	KTG667PS6408NST-C6 GDBTX	.	.	.
1G	ELIXIR	M2Y1G64TU8HA2B-3C	5	ELIXIR	DS	M2TU51280AE-3C717095R28F	.	.	.
1G	Leadmax	LRRP512U64A8-Y5	N/A	Hynix	DS	HY5PS12821CFP-Y5 C 702AA	.	.	.

DDR2 800 Qualified Vendors List

Size	Vendor	Part No.	CL	Chip Brand	SS/ DS	Chip No.	DIMM support		
							A*	B*	C*
1G	Kingston	KHX6400D2LL/1G	N/A	Kingston	DS	Heat-Sink Package	•	•	
512MB	Kingston	KHX6400D2LLK2/1GN	N/A	Kingston	SS	Heat-Sink Package	•	•	
512MB	Kingston	KVR800D2N5/512	N/A	Promos	SS	V59C1512804QCF25SY032406PECPA	•	•	
1G	Kingston	KHX6400D2K2/2G	N/A	Kingston	DS	Heat-Sink Package	•	•	
512MB	Samsung	KR M378T6553CZ3-CE7	N/A	Samsung	SS	K4T51083QC-ZCE7	•	•	
1G	Samsung	KR M378T2953CZ3-CE7	N/A	Samsung	DS	K4T51083QC-ZCE7	•	•	
512MB	Qimonda	HYS64T64000EU-2.5-B2	6	Qimonda	SS	HYB18T512800B2F25FSS28380	•	•	
1G	Qimonda	HYS64T128020EU-2.5-B2	6	Qimonda	DS	HYB18T512800B2F25FSS28380	•	•	
1G	Corsair	XMS2-6400	4	Corsair	DS	Heat-Sink Package	•	•	
1G	Corsair	XMS2-6400	5	Corsair	DS	Heat-Sink Package	•	•	
512MB	HY	HYMP564U64AP8-S6 AA	N/A	Hynix	SS	HY5PS12821AFP-S6	•	•	
512MB	HY	HYMP564U64BP8-S5 AB	N/A	Hynix	SS	HY5PS12821BFP-S5	•	•	•
512MB	HY	HYMP564U64CP8-S5 AB	5	Hynix	SS	HY5PS12821CFP-S5	•	•	
1G	HY	HYMP512U64AP8-S6 AA	N/A	Hynix	DS	HY5PS12821AFP-S6	•	•	
1G	HY	HYMP512U64BP8-S5 AB	5	Hynix	DS	HY5PS12821BFP-S5	•	•	
1G	HY	HYMP512U64CP8-S5 AB	5	Hynix	DS	HY5PS12821CFPS5	•	•	
512MB	Kingmax	KLDC28F-A8K15	N/A	Kingmax	SS	KKABFF1XF-JFS-25A	•	•	•
1G	Kingmax	KLDD48F-A8K15	N/A	Kingmax	DS	KKABFF1XF-HFS-25A	•	•	
1G	Apacer	78.01GA0.9K5	5	Apacer	SS	AM4B580CQJS8E0749D	•	•	
2G	Apacer	78.A1GA0.9K4	5	Apacer	DS	AM4B580CQJS8E0740E	•	•	
2G	Apacer	78.A1GA0.9K4	5	Apacer	DS	AM4B580CQJS8E0747D	•	•	
512MB	ADATA	M20AD6G3H3160I1E58	N/A	ADATA	SS	AD29608A8A-25EG80720	•	•	
512MB	VDATA	M2GVD6G3H3160I1E53	N/A	VDATA	SS	VD29608A8A-25EG30648	•	•	
1G	VDATA	M2GVD6G3I4170I1E53	N/A	VDATA	DS	VD29608A8A-25EG30647	•	•	
1G	PSC	AL7E8F73C-8E1	5	PSC	SS	A3R1GE3CFF734MAA0E	•	•	
2G	PSC	AL8E8F73C-8E1	5	PSC	DS	A3R1GE3CFF734MAA0E	•	•	
1G	Super Talent	T800UB1GC4	4	Super Talent	DS	Heat-Sink Package	•	•	



SS - Single-sided / DS - Double - sided DIMM support:

- **A*:** Supports one module inserted into any slot as Single-channel memory configuration.
- **B*:** Supports one pair of modules inserted into the yellow slot and the black slots.
- **C*:** Supports the same modules of one-sided memory inserted in all slots.



Visit the ASUS website for the latest DDR2-533/667/800 MHz QVL.

1.7.4 Installing a DIMM



Unplug the power supply before adding or removing DIMMs or other system components. Failure to do so can cause severe damage to both the motherboard and the components.

To install a DIMM:

1. Unlock a DIMM socket by pressing the retaining clips outward.
2. Align a DIMM on the socket such that the notch on the DIMM matches the break on the socket.
3. Firmly insert the DIMM into the socket until the retaining clips snap back in place and the DIMM is properly seated.

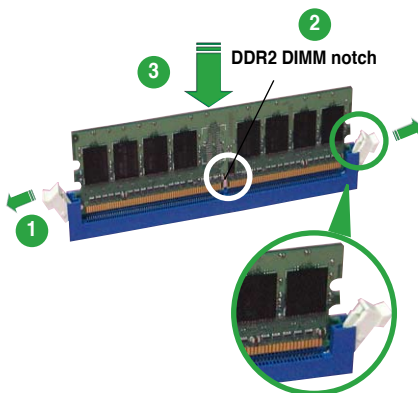

Unlocked retaining clip



- A DDR2 DIMM is keyed with a notch so that it fits in only one direction. Do not force a DIMM into a socket to avoid damaging the DIMM.
- The DDR2 DIMM sockets do not support DDR DIMMs. DO not install DDR DIMMs to the DDR2 DIMM sockets.

1.7.5 Removing a DIMM

Follow these steps to remove a DIMM.

1. Simultaneously press the retaining clips outward to unlock the DIMM.



Support the DIMM lightly with your fingers when pressing the retaining clips. The DIMM might get damaged when it flips out with extra force.

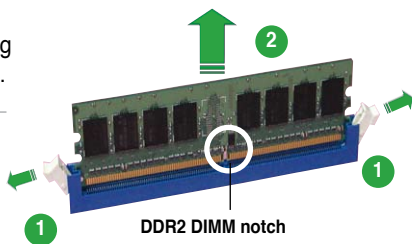

2. Remove the DIMM from the socket.

1.8 Expansion slots

In the future, you may need to install expansion cards. The following sub-sections describe the slots and the expansion cards that they support.



Ensure to unplug the power cord before adding or removing expansion cards. Failure to do so may cause you physical injury and damage motherboard components.

1.8.1 Installing an expansion card

To install an expansion card:

1. Before installing the expansion card, read the documentation that came with it and make the necessary hardware settings for the card.
2. Remove the system unit cover (if your motherboard is already installed in a chassis).
3. Remove the bracket opposite the slot that you intend to use. Keep the screw for later use.
4. Align the card connector with the slot and press firmly until the card is completely seated on the slot.
5. Secure the card to the chassis with the screw you removed earlier.
6. Replace the system cover.

1.8.2 Configuring an expansion card

After installing the expansion card, configure it by adjusting the software settings.

1. Turn on the system and change the necessary BIOS settings, if any. See Chapter 2 for information on BIOS setup.
2. Assign an IRQ to the card. Refer to the tables on the next page.
3. Install the software drivers for the expansion card.

1.8.3 Interrupt assignments

Standard interrupt assignments

IRQ	Standard Function
0	High precision event timer
1	Standard 101/102-key or Microsoft PS/2 keyboard
4	Communicators Port (COM1)
6	Standard floppy disk controller
8	High precision event timer
9	Microsoft ACPI-Compliant System
12	PS/2 Compatible Mouse
13	Numeric data processor
11	NVIDIA nForce PCI System Management
20	Standard OpenHCD USB Host Controller
21	Microsoft UAA Bus Driver for High Definition Audio
21	Standard Dual Channel PCI IDE Controller
22	NVIDIA GeForce 7050 / nForce 630i
22	Standard Enhanced PCI to USB Host Controller
23	NVIDIA Network Bus Enumerator

* These IRQs are usually available for ISA or PCI devices.

IRQ assignments for this motherboard

External devices interrupt

	PIRQ1	PIRQ2	PIRQ3	PIRQ4	PIRQ5	PIRQ6	PIRQ7	PIRQ8
PCI slot 1	shared	—	—	—	—	—	—	—
PCI slot 2	—	shared	—	—	—	—	—	—
Onboard USB controller	—	—	—	—	—	—	—	—
Onboard USB 2.0 controller	—	—	—	—	—	—	—	—
Onboard IDE controller	—	—	—	—	—	—	—	—
Onboard HD Audio	—	—	—	—	—	—	—	—
PCI Express x16 slot	—	—	—	—	—	shared	—	—
PCI Express x1 slot	—	—	—	—	shared	—	—	—
Onboard SATA controller	—	—	—	—	—	—	—	—
Onboard LAN	—	—	—	—	—	—	—	—
Onboard VGA	—	—	—	—	—	—	—	—

Internal devices interrupt

	MCP _USB	MCP _MAC	MCP _AZA	MCP _IGPU	MCP _IDE	MCP _USB2	MCP _AHCI
PCI slot 1	—	—	—	—	—	—	—
PCI slot 2	—	—	—	—	—	—	—
Onboard USB controller	shared	—	—	—	—	—	—
Onboard USB 2.0 controller	—	—	—	—	—	shared	—
Onboard IDE controller	—	—	—	—	shared	—	—
Onboard HD Audio	—	—	shared	—	—	—	—
PCI Express x16 slot	—	—	—	—	—	—	—
PCI Express x1 slot	—	—	—	—	—	—	—
Onboard SATA controller	—	—	—	—	—	—	shared
Onboard LAN	—	shared	—	—	—	—	—
Onboard VGA	—	—	—	shared	—	—	—



When using PCI cards on shared slots, ensure that the drivers support “Share IRQ” or that the cards do not need IRQ assignments. Otherwise, conflicts will arise between the two PCI groups, making the system unstable and the card inoperable.

1.8.4 PCI slots

The PCI slots support cards such as a LAN card, SCSI card, USB card, and other cards that comply with PCI specifications. The figure shows a LAN card installed on a PCI slot.



If you install a PCI graphics card, we recommend that you remove the onboard graphics card driver.

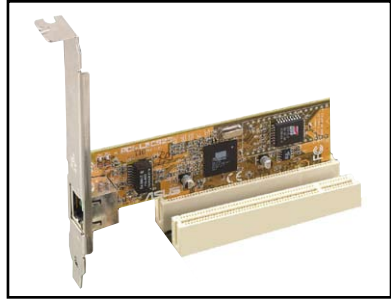

1.8.5 PCI Express x1 slot

This motherboard supports PCI Express x1 network cards, SCSI cards and other cards that comply with the PCI Express specifications. The following figure shows a network card installed on the PCI Express x1 slot.



1.8.6 PCI Express x16 Slot

This motherboard supports one PCI Express x16 graphics card. The figure shows a graphics card installed on the PCI Express x16 slot.

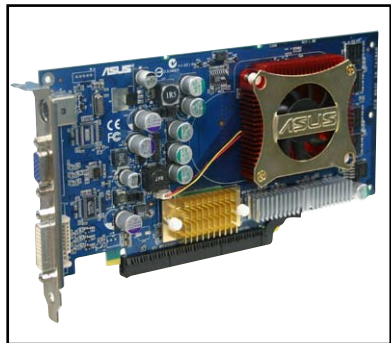

1.9 Jumpers

1. Clear RTC RAM (CLRRTC)

This jumper allows you to clear the Real Time Clock (RTC) RAM in CMOS. You can clear the CMOS memory of date, time, and system setup parameters by erasing the CMOS RTC RAM data. The onboard button cell battery powers the RAM data in CMOS, which include system setup information such as system passwords.

To erase the RTC RAM:

1. Turn OFF the computer and unplug the power cord.
2. Remove the onboard battery.
3. Move the jumper cap from pins 1-2 (default) to pins 2-3. Keep the cap on pins 2-3 for about 5~10 seconds, then move the cap back to pins 1-2.
4. Re-install the battery.
5. Plug the power cord and turn ON the computer.
6. Hold down the key during the boot process and enter BIOS setup to re-enter data.



Except when clearing the RTC RAM, never remove the cap on CLRRTC jumper default position. Removing the cap will cause system boot failure!

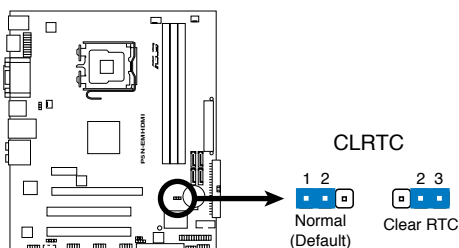

P5N-EM HDMI Clear RTC RAM

2. USB device wake-up (3-pin PS2_USBPW)

Set these jumpers to +5V to wake up the computer from S1 sleep mode (CPU stopped, DRAM refreshed, system running in low power mode) using the connected USB devices. Set to +5VSB to wake up from S3 and S4 sleep modes (no power to CPU, DRAM in slow refresh, power supply in reduced power mode).

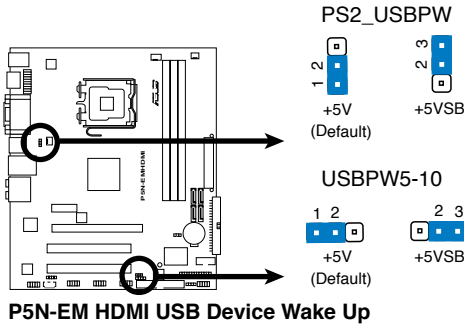

- The USB device wake-up feature requires a power supply that can provide 500mA on the +5VSB lead for each USB port; otherwise, the system would not power up.
- The total current consumed must NOT exceed the power supply capability (+5VSB) whether under normal condition or in sleep mode.

3. HDJ1

This jumper allows you to twitch between the HDMI and the DVI features. Set this jumper to pins 1-2 (HDMI) to enable the HDMI feature. Set this jumper to pins 2-3 to enable the DVI feature.

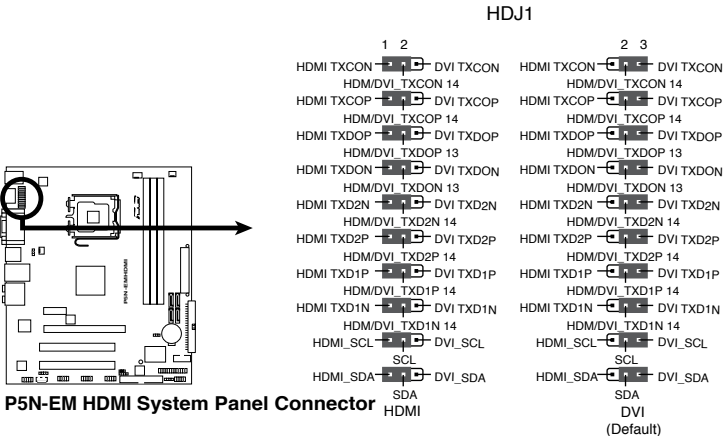

1.10 Connectors

1.10.1 Rear panel connectors

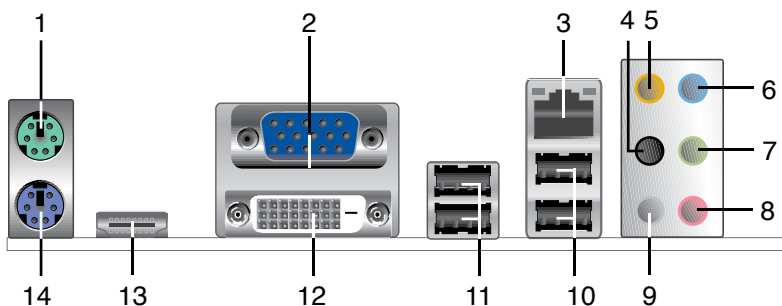

1. **PS/2 mouse port (green).** This port is for a PS/2 mouse.
2. **Video Graphics Adapter (VGA) port.** This 15-pin port is for a VGA monitor or other VGA-compatible devices.
3. **LAN (RJ-45) port.** Supported by Marvell Gigabit LAN controller, this port allows Gigabit connection to a Local Area Network (LAN) through a network hub. Refer to the table below for the LAN port LED indications.

LAN port LED indications

Activity/Link LED		Speed LED	
Status	Description	Status	Description
OFF	No link	OFF	10 Mbps connection
ORANGE	Linked	ORANGE	100 Mbps connection
BLINKING	Data activity	GREEN	1 Gbps connection

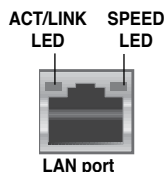

4. **Rear Speaker Out port (black).** This port connects the rear speakers in a 4-channel, 6-channel, or 8-channel audio configuration..
5. **Center / Subwoofer port (orange).** This port connects the center / subwoofer speakers.
6. **Line In port (light blue).** This port connects the tape, CD, DVD player, or other audio sources.
7. **Line Out port (lime).** This port connects a headphone or a speaker. In 4-channel, 6-channel, and 8-channel configuration, the function of this port becomes Front Speaker Out.
8. **Microphone port (pink).** This port connects a microphone.
9. **Side Speaker Out port (gray).** This port connects the side speakers in an 8-channel audio configuration.



Refer to the audio configuration table below for the function of the audio ports in 2, 4, 6 or 8-channel configuration.

Audio 2, 4, 6, or 8-channel configuration

Port	Headset 2-channel	4-channel	6-channel	8-channel
Light Blue	Line In	Line In	Line In	Line In
Lime	Line Out	Front Speaker Out	Front Speaker Out	Front Speaker Out
Pink	Mic In	Mic In	Mic In	Mic In
Orange	–	–	Center/Subwoofer	Center/Subwoofer
Black	–	Rear Speaker Out	Rear Speaker Out	Rear Speaker Out
Gray	–	–	–	Side Speaker Out

- 10. USB 2.0 ports 1 and 2.** These two 4-pin Universal Serial Bus (USB) ports are available for connecting USB 2.0 devices.
- 11. USB 2.0 ports 3 and 4.** These two 4-pin Universal Serial Bus (USB) ports are available for connecting USB 2.0 devices.
- 12. DVI port.** This port is for any DVI-D compatible device. DVI-D can't be converted to output RGB Signal to CRT and isn't compatible with DVI-I.
- 13. HDMI port.** This port is for a High-Definition Multimedia Interface (HDMI) connector, and is HDCP compliant allowing playback of HD DVD, Blu-Ray and other protected content



- This motherboard comes with dual-VGA output. If you connect 2 monitors to both VGA and DVI-D / HDMI out ports, each controller can drive same or different display contents to different resolutions and refresh rates.
- To play HD DVD or Blu-Ray Disc, ensure to use an HDCP compliant monitor.

Playback of HD DVD and Blu-Ray Discs

The speed and bandwidth of the CPU/Memory, DVD player, and drivers will affect the playback quality. Using the CPU/Memory of higher speed and bandwidth with the higher-version DVD player and drivers will upgrade the playback quality.

- 14. PS/2 keyboard port (purple).** This port is for a PS/2 keyboard.

1.10.2 Internal connectors

1. Floppy disk drive connector (34-pin FLOPPY)

This connector is for the provided floppy disk drive (FDD) signal cable. Insert one end of the cable to this connector, then connect the other end to the signal connector at the back of the floppy disk drive.



Pin 5 on the connector is removed to prevent incorrect cable connection when using an FDD cable with a covered Pin 5.

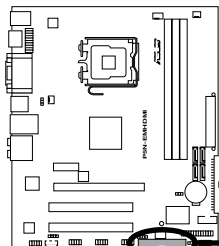

FLOPPY



PIN 1

NOTE: Orient the red markings on the floppy ribbon cable to PIN 1.

P5N-EM HDMI Floppy Disk Drive Connector

2. Serial ATA connectors (7-pin SATA1, SATA2, SATA3, SATA4)

These connectors are for the Serial ATA signal cables for Serial ATA hard disk drives.

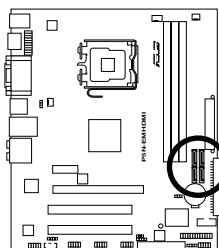

SATA2

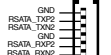

SATA3



SATA1

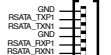

SATA4



P5N-EM HDMI SATA Connectors



3. IDE connector (40-1 pin PRI_IDE)

The onboard IDE connector is for Ultra DMA 133 / 100 / 66 / 33 signal cable. There are three connectors on each Ultra DMA 100/66/33 signal cable: blue, black, and gray. Connect the blue connector to the motherboard's IDE connector, then select one of the following modes to configure your device(s).

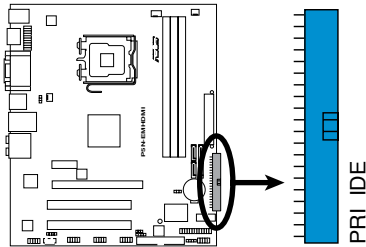

P5N-EM HDMI IDE Connector

	Drive jumper setting	Mode of device(s)	Cable connector
Single device	Cable-Select or Master	-	Black
Two devices	Cable-Select	Master	Black
		Slave	Gray
	Master	Master	Black or gray
	Slave	Slave	



- Pin 20 on the IDE connector is removed to match the covered hole on the Ultra DMA cable connector. This prevents incorrect insertion when you connect the IDE cable.
- Use the 80-conductor IDE cable for Ultra DMA 133 / 100 / 66 / 33 IDE devices.



If any device jumper is set as "Cable-Select," ensure that all other device jumpers have the same setting.

4. Speaker connector (4-pin SPEAKER)

This 4-pin connector is for the chassis-mounted system warning speaker. The speaker allows you to hear system beeps and warnings.

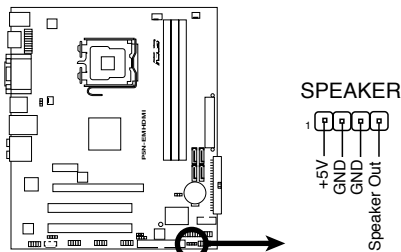

P5N-EM HDMI Speaker Out Connector

5. CPU, Chassis, and Power fan connectors (4-pin CPU_FAN, 3-pin CHA_FAN, 3-pin PWR_FAN)

The fan connectors support cooling fans of a total of 1A~2.2A (26.4W max.) at +12V. Connect the fan cables to the fan connectors on the motherboard, making sure that the black wire of each cable matches the ground pin of the connector.



Do not forget to connect the fan cables to the fan connectors. Insufficient air flow inside the system may damage the motherboard components. These are not jumpers! DO NOT place jumper caps on the fan connectors.

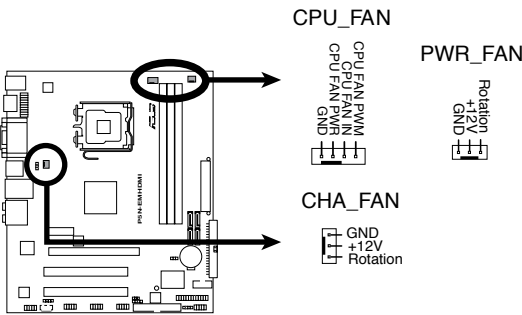

P5N-EM HDMI Fan Connectors

6. Digital Audio connector (4-1 pin SPDIF_OUT)

This connector is for the S/PDIF audio module to allow digital sound output. Connect one end of the S/PDIF audio cable to this connector and the other end to the S/PDIF module.

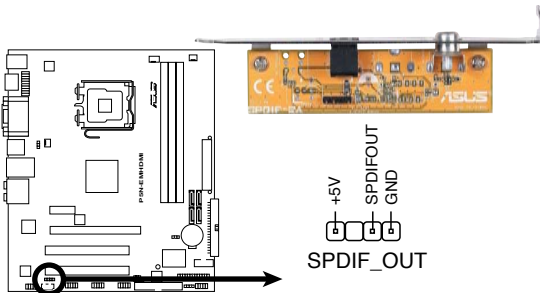

P5N-EM HDMI Digital Audio Connector



The S/PDIF out module is purchased separately.

7. ATX power connectors (24-pin EATXPWR and 4-pin ATX12V)

These connectors are for ATX power supply plugs. The power supply plugs are designed to fit these connectors in only one orientation. Find the proper orientation and push down firmly until the connectors completely fit.



- Do not forget to connect the 4-pin ATX +12 V power plug; otherwise, the system will not boot.
- Use of a PSU with a higher power output is recommended when configuring a system with more power-consuming devices. The system may become unstable or may not boot up if the power is inadequate.
- Ensure that your power supply unit (PSU) can provide at least the minimum power required by your system.
- If you intend to use a PSU with 20-pin and 4-pin power plugs, ensure that the 20-pin power plug can provide at least 15A on +12V and that the PSU has a minimum power rating of 350 W. The system may become unstable or may not boot up if the power is inadequate.
- You must install a PSU with a higher power rating if you intend to install additional devices.

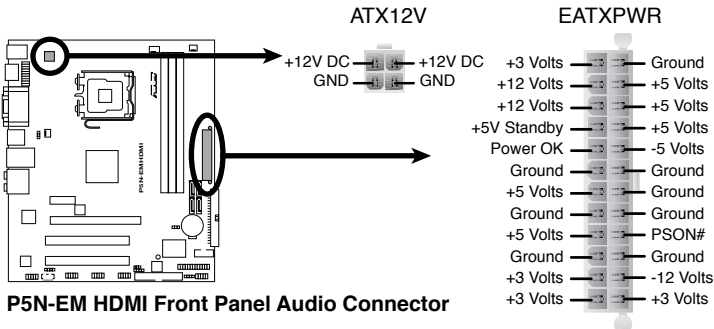

8. Optical drive audio connector (4-pin CD)

This connector allows you to receive stereo audio input from sound sources such as a CD-ROM, TV tuner, or MPEG card.

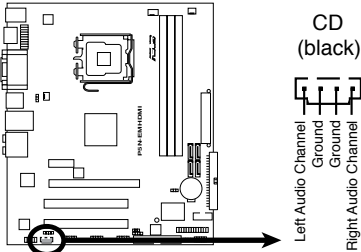

P5N-EM HDMI Internal Audio Connector



Enable the CD-IN function in the audio utility when using this connector.

9. USB connectors (10-1 pin USB56, USB78, USB910)

These connectors are for USB 2.0 ports. Connect the USB module cable to any of these connectors, then install the module to a slot opening at the back of the system chassis. These USB connectors comply with USB 2.0 specification that supports up to 480 Mbps connection speed.

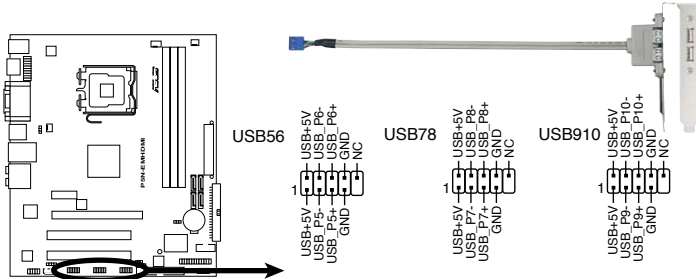

P5N-EM HDMI USB 2.0 Connectors



Never connect a 1394 cable to the USB connectors. Doing so will damage the motherboard!



The USB module is purchased separately.

10. Front panel audio connector (10-1 pin AAFP)

This connector is for a chassis-mounted front panel audio I/O module that supports either HD Audio or legacy AC'97 audio standard.

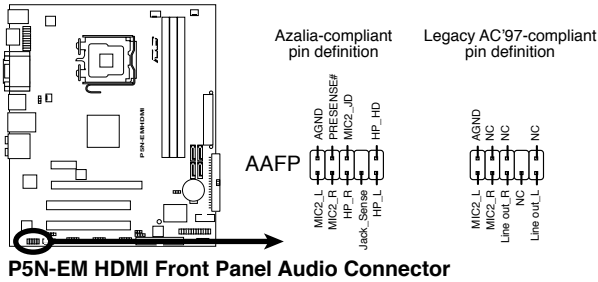

- We recommend that you connect a high-definition front panel audio module to this connector to avail of the motherboard's high-definition audio capability.
- By default, this connector is set to AC97 Audio. If you want to connect a High Definition front panel audio module to this connector, set the **Front Panel Support Type** item in the BIOS to [HD Audio]. See section "2.4.5 Onboard Device Configuration" for details.

11. Chassis intrusion connector (4-1 pin CHASSIS)

This connector is for a chassis-mounted intrusion detection sensor or switch. Connect one end of the chassis intrusion sensor or switch cable to this connector. The chassis intrusion sensor or switch sends a high-level signal to this connector when a chassis component is removed or replaced. The signal is then generated as a chassis intrusion event.

By default, the pins labeled "Chassis Signal" and "Ground" are shorted with a jumper cap. Remove the jumper caps only when you intend to use the chassis intrusion detection feature.

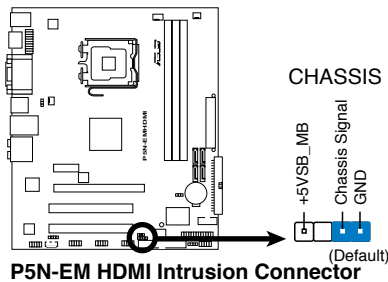

12. Serial port connectors (10-1 pin COM1)

The connector is for a serial (COM) port. Connect the serial port module cable to the connector, then install the module to a slot opening at the back of the system chassis.



The serial port bracket (COM1) is purchased separately.

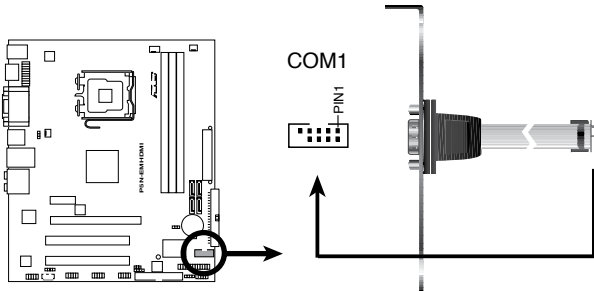

P5N-EM HDMI COM Port Connector

13. LPT connector (26-1 pin LPT)

The LPT (Line Printing Terminal) connector supports devices such as a printer. LPT standardizes as IEEE 1394, which is the parallel port interface on IBM PC-compatible computers.

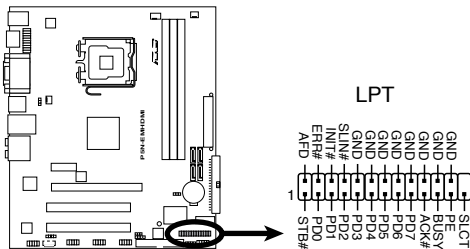

P5N-EM HDMI Parallel Port Connector

14. System panel connector (10-1 pin F_PANEL)

This connector supports several chassis-mounted functions.

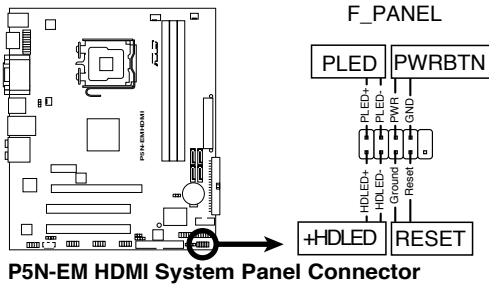

- **System power LED (2-pin PLED)**

This 2-pin connector is for the system power LED. Connect the chassis power LED cable to this connector. The system power LED lights up when you turn on the system power, and blinks when the system is in sleep mode.

- **Hard disk drive activity LED (2-pin +HDLED)**

This 2-pin connector is for the HDD Activity LED. Connect the HDD Activity LED cable to this connector. The IDE LED lights up or flashes when data is read from or written to the HDD.

- **ATX power button/soft-off button (2-pin PWRBTN)**

This connector is for the system power button. Pressing the power button turns the system on or puts the system in sleep or soft-off mode depending on the BIOS settings. Pressing the power switch for more than four seconds while the system is ON turns the system OFF.

- **Reset button (2-pin RESET)**

This 2-pin connector is for the chassis-mounted reset button for system reboot without turning off the system power.

This chapter tells how to change the system settings through the BIOS Setup menus. Detailed descriptions of the BIOS parameters are also provided.

BIOS setup **2**

2.1 Managing and updating your BIOS

The following utilities allow you to manage and update the motherboard Basic Input/Output System (BIOS) setup.

1. **ASUS Update:** Updates the BIOS in Windows® environment.
2. **ASUS EZ Flash 2:** Updates the BIOS using a floppy disk/ USB flash disk or the motherboard support CD / DVD.
3. **AwardBIOS Flash Utility:** Updates the BIOS in DOS mode using a bootable floppy disk.
4. **ASUS CrashFree BIOS 2:** Updates the BIOS using a bootable floppy disk, or the motherboard support CD when the BIOS file fails or gets corrupted.

Refer to the corresponding sections for details on these utilities.



Save a copy of the original motherboard BIOS file to a bootable floppy disk in case you need to restore the BIOS in the future. Copy the original motherboard BIOS using the ASUS Update or AFUDOS utilities.

2.1.1 ASUS Update utility

The ASUS Update is a utility that allows you to manage, save, and update the motherboard BIOS in Windows® environment. The ASUS Update utility allows you to:

- Save the current BIOS file
- Download the latest BIOS file from the Internet
- Update the BIOS from an updated BIOS file
- Update the BIOS directly from the Internet, and
- View the BIOS version information.

This utility is available in the support CD that comes with the motherboard package.



ASUS Update requires an Internet connection either through a network or an Internet Service Provider (ISP).

Installing ASUS Update

To install ASUS Update:

1. Place the support CD / DVD in the optical drive. The Drivers menu appears.
2. Click the Utilities tab, then click Install ASUS Update VX.XX.XX. See page 3-4 for the Utilities screen menu.
3. The ASUS Update utility is copied to your system.



Quit all Windows® applications before you update the BIOS using this utility.

Updating the BIOS through the Internet

To update the BIOS through the Internet:

1. Launch the ASUS Update utility from the Windows® desktop by clicking **Start > Programs > ASUS > ASUSUpdate > ASUSUpdate**. The ASUS Update main window appears.

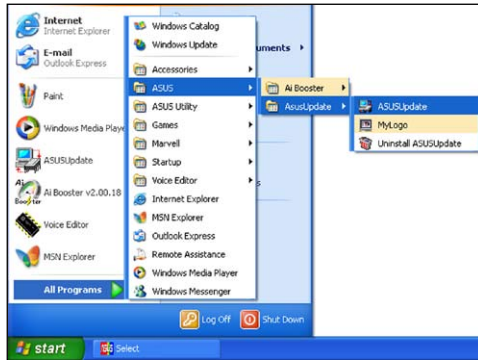

2. Select **Update BIOS from the Internet** option from the drop-down menu, then click **Next**.



3. Select the ASUS FTP site nearest you to avoid network traffic, or click **Auto Select**. Click **Next**.

- From the FTP site, select the BIOS version that you wish to download. Click Next.
- Follow the screen instructions to complete the update process.



The ASUS Update utility is capable of updating itself through the Internet. Always update the utility to avail all its features.

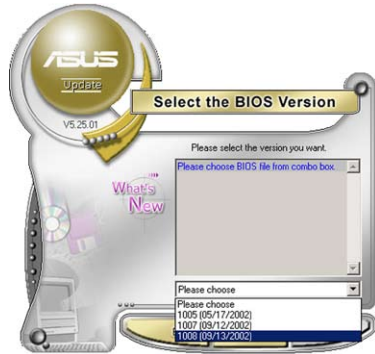

Updating the BIOS through a BIOS file

To update the BIOS through a BIOS file:

- Launch the ASUS Update utility from the Windows® desktop by clicking Start > Programs > ASUS > ASUSUpdate > ASUSUpdate. The ASUS Update main window appears.
- Select Update BIOS from a file option from the drop-down menu, then click Next.

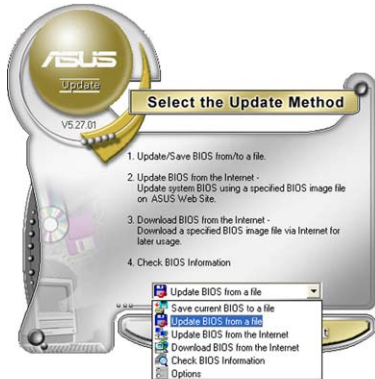

- Locate the BIOS file from the Open window, then click Open.
- Follow the screen instructions to complete the update process.

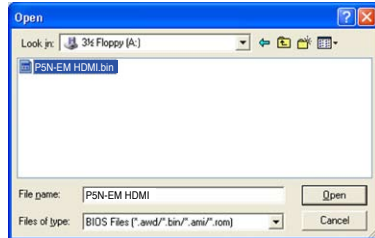

2.1.2 Creating a bootable floppy disk

1. Do either one of the following to create a bootable floppy disk.

DOS environment

- a. Insert a 1.44MB floppy disk into the drive.
- b. At the DOS prompt, type **format A:/S** then press <Enter>.

Windows® XP environment

- a. Insert a 1.44 MB floppy disk to the floppy disk drive.
- b. Click **Start** from the Windows® desktop, then select **My Computer**.
- c. Select the 3 1/2 Floppy Drive icon.
- d. Click **File** from the menu, then select **Format**. A Format 3 1/2 Floppy Disk window appears.
- e. Windows® XP users: Select **Create an MS-DOS startup disk** from the format options field, then click **Start**.

Windows® Vista environment

- a. Insert a formatted, high density 1.44 MB floppy disk to the floppy disk drive.
 - b. Click  from the Windows® desktop, then select **Computer**.
 - c. Right-click **Floppy Disk Drive** then click **Format** to display the **Format 3 1/2 Floppy** dialog box.
 - d. Select the **Create an MS-DOS startup disk** check box.
 - e. Click **Start**.
2. Copy the original or the latest motherboard BIOS file to the bootable floppy disk.

2.1.3 ASUS EZ Flash 2 utility

The ASUS EZ Flash 2 feature allows you to update the BIOS without having to go through the long process of booting from a floppy disk and using a DOS-based utility. The EZ Flash 2 utility is built-in the BIOS chip so it is accessible by pressing <Alt> + <F2> during the Power-On Self Tests (POST).

To update the BIOS using EZ Flash 2:

1. Visit the ASUS website (www.asus.com) to download the latest BIOS file for the motherboard.
2. Save the BIOS file to a floppy disk, then restart the system.
3. You can launch the EZ Flash 2 by two methods.

(1) Insert the floppy disk/USB flash disk that contains the BIOS file to the floppy disk drive or the USB port.

Press <Alt> + <F2> during POST to display the following.

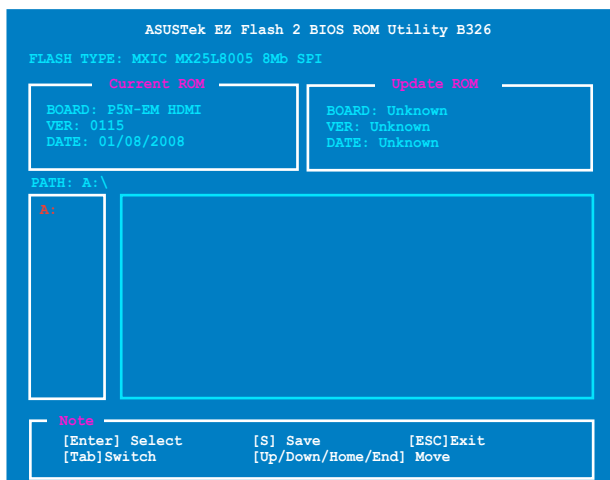

(2) Enter BIOS setup program. Go to the Tools menu to select EZ Flash 2 and press <Enter> to enable it.

You can switch between drives by pressing <Tab> before the correct file is found. Then press <Enter>.

4. When the correct BIOS file is found, EZ Flash 2 performs the BIOS update process and automatically reboots the system when down.



- This function can support devices such as USB flash disk, hard disk, or floppy disk with FAT32/16/12 format only.
- Do not shut down or reset the system while updating the BIOS to prevent system boot failure!

2.1.4 Updating the BIOS

The Basic Input/Output System (BIOS) can be updated using the AwardBIOS Flash Utility. Follow these instructions to update the BIOS using this utility.

1. Download the latest BIOS file from the ASUS web site. Rename the file to P5N-EM HDMI.BIN and save it to a floppy disk, CD ROM or a USB flash disk in FAT 16/12 format.



Save only the updated BIOS file in the floppy disk to avoid loading the wrong BIOS file.

2. Copy the AwardBIOS Flash Utility (awdfash.exe) from the Software folder of the support CD to the floppy disk, CD ROM or a USB flash disk with the latest BIOS file.
3. Boot the system in DOS mode using the bootable floppy disk, CD ROM or a USB flash disk you created earlier.
4. Under the DOS mode, use <X> (X stands for the name of the disk assignment) to switch to the folder of the floppy disk, CD ROM or USB flash disk you saved the BIOS file and the Award BIOS Flash Utility.
5. At the prompt, type awdfash then press <Enter>. The Award BIOS Flash Utility screen appears.

```
AwardBIOS Flash Utility for ASUS V1.17
(C) Phoenix Technologies Ltd. All Rights Reserved

For 690G-SB600-P5N-EM HDMI_H-00      DATE:
12/12/2006
Flash Type - Winbond W39V080A (8Mb)

File Name to Program: 

Message: Please input File Name!
```

6. Type the BIOS file name in the File Name to Program field, then press <Enter>.

```
AwardBIOS Flash Utility for ASUS V1.17
(C) Phoenix Technologies Ltd. All Rights Reserved

For 690G-SB600-P5N-EM HDMI_H-00      DATE:
12/12/2006
Flash Type - Winbond W39V080A (8Mb)

File Name to Program: P5N-EM HDMI.bin

Message: Please input File Name!
```

7. Press <N> when the utility prompts you to save the current BIOS file. The following screen appears.
8. The utility verifies the BIOS file in the floppy disk, CD ROM or a USB flash disk and starts flashing the BIOS file.

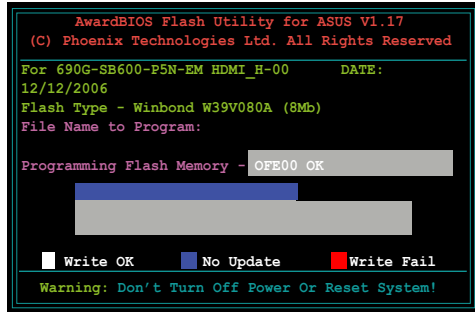

Do not turn off or reset the system during the flashing process!

9. The utility displays a Flashing Complete message indicating that you have successfully flashed the BIOS file. Remove the floppy disk then press <F1> to restart the system.

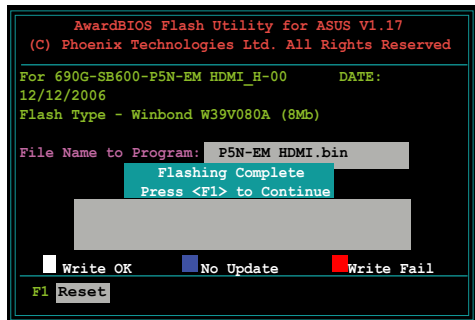

2.1.5 Saving the current BIOS file

You can use the AwardBIOS Flash Utility to save the current BIOS file. You can load the current BIOS file when the BIOS file gets corrupted during the flashing process.



Ensure that the floppy disk, CD ROM or a USB flash disk has enough disk space to save the file.

To save the current BIOS file using the AwardBIOS Flash Utility:

1. Follow steps 1 to 6 of the previous section.
2. Press <Y> when the utility prompts you to save the current BIOS file. The following screen appears.

```
AwardBIOS Flash Utility for ASUS V1.17
(C) Phoenix Technologies Ltd. All Rights Reserved

For 690G-SB600-P5N-EM HDMI_H-00    DATE:
12/12/2006
Flash Type - Winbond W39V080A (8Mb)

File Name to Program: 0113.bin
Save current BIOS as:

Message:
```

3. Type a filename for the current BIOS file in the Save current BIOS as field, then press <Enter>.

```
AwardBIOS Flash Utility for ASUS V1.17
(C) Phoenix Technologies Ltd. All Rights Reserved

For 690G-SB600-P5N-EM HDMI_H-00    DATE:
12/12/2006
Flash Type - Winbond W39V080A (8Mb)

File Name to Program: 0113.bin
Checksum: D800H
Save current BIOS as: 0112.bin

Message: Please Wait!
```

4. The utility saves the current BIOS file to the floppy disk, then returns to the BIOS flashing process.

```
AwardBIOS Flash Utility for ASUS V1.17
(C) Phoenix Technologies Ltd. All Rights Reserved

For 690G-SB600-P5N-EM HDMI_H-00    DATE:
12/12/2006
Flash Type - Winbond W39V080A (8Mb)

File Name to Program: 0113.bin
Now Backup System BIOS to
File!

Message: Please Wait!
```

2.1.6 ASUS CrashFree BIOS 2 utility

The ASUS CrashFree BIOS 2 is an auto recovery tool that allows you to restore the BIOS file when it fails or gets corrupted during the updating process. You can update a corrupted BIOS file using the motherboard support CD or the floppy disk that contains the updated BIOS file.



- Prepare the motherboard support CD, or the floppy disk containing the updated motherboard BIOS before using this utility.
- Ensure that you rename the original or updated BIOS file in the floppy disk or the USB flash disk to **P5N-EMHDMI.ROM**.

Recovering the BIOS from a floppy disk

To recover the BIOS from a floppy disk:

1. Turn on the system.
2. Insert the floppy disk with the original or updated BIOS file to the floppy disk drive.
3. The utility displays the following message and automatically checks the floppy disk for the original or updated BIOS file.

```
Bad BIOS checksum. Starting BIOS recovery...
Checking for floppy...
```

When found, the utility reads the BIOS file and starts flashing the corrupted BIOS file.

```
Bad BIOS checksum. Starting BIOS recovery...
Checking for floppy...
Floppy found!
Reading file "P5N-EMHDMI.ROM". Completed.
Start flashing...
```



DO NOT shut down or reset the system while updating the BIOS! Doing so can cause system boot failure!

4. Restart the system after the utility completes the updating process.

Recovering the BIOS from the support CD

To recover the BIOS from the support CD:

1. Remove any floppy disk from the floppy disk drive, then turn on the system.
2. Insert the support CD to the optical drive.
3. The utility displays the following message and automatically checks the floppy disk for the original or updated BIOS file.

```
Bad BIOS checksum. Starting BIOS recovery...  
Checking for floppy...
```

When no floppy disk is found, the utility automatically checks the optical drive for the original or updated BIOS file. The utility then updates the corrupted BIOS file.

```
Bad BIOS checksum. Starting BIOS recovery...  
Checking for floppy...  
Floppy not found!  
Checking for CD-ROM...  
CD-ROM found!  
Reading file "P5N-EMHDMI.ROM". Completed.  
Start flashing...
```

4. Restart the system after the utility completes the updating process.



The recovered BIOS may not be the latest BIOS version for this motherboard.
Visit the ASUS website (www.asus.com) to download the latest BIOS file.

2.2 BIOS setup program

This motherboard supports a programmable Serial Peripheral Interface (SPI) chip that you can update using the provided utility described in section “2.1 Managing and updating your BIOS”.

Use the BIOS Setup program when you are installing a motherboard, reconfiguring your system, or prompted to “Run Setup”. This section explains how to configure your system using this utility.

Even if you are not prompted to use the Setup program, you can change the configuration of your computer in the future. For example, you can enable the security password feature or change the power management settings. This requires you to reconfigure your system using the BIOS Setup program so that the computer can recognize these changes and record them in the CMOS RAM of the SPI chip.

The SPI chip on the motherboard stores the Setup utility. When you start up the computer, the system provides you with the opportunity to run this program. Press during the Power-On Self-Test (POST) to enter the Setup utility. Otherwise, POST continues with its test routines.

If you wish to enter Setup after POST, reboot the system by doing any of the following procedures:

- Restart using the OS standard shut-down procedure.
- Press <Ctrl>+<Alt>+ simultaneously.
- Press the reset button on the system chassis.
- Press the power button to turn the system off then back on.



Using the **power button**, **reset button**, or the **<Ctrl>+<Alt>+** keys to force reset from a running operating system can cause damage to your data or system. We recommend to always shut-down the system properly from the operating system.

The Setup program is designed to make it as easy to use as possible. Being a menu-driven program, it lets you scroll through the various sub-menus and make your selections from the available options using the navigation keys.



-
- The default BIOS settings for this motherboard apply for most conditions to ensure optimum performance. If the system becomes unstable after changing any BIOS settings, load the default settings to ensure system compatibility and stability. Select the **Load Default Settings** item under the Exit Menu. See section “2.8 Exit Menu.”
 - The BIOS setup screens shown in this section are for reference purposes only, and may not exactly match what you see on your screen.
 - Visit the ASUS website (www.asus.com) to download the latest BIOS file for this motherboard.
-

2.2.1 BIOS menu screen

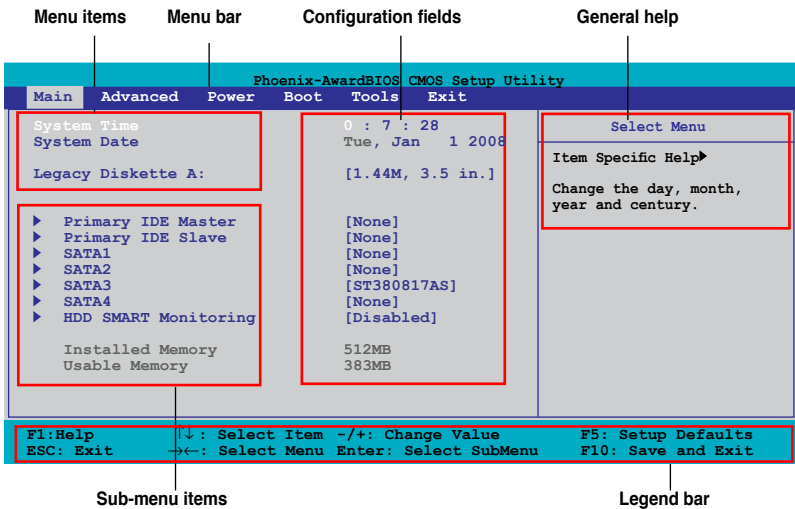

2.2.2 Menu bar

The menu bar on top of the screen has the following main items:

- Main** For changing the basic system configuration
- Advanced** For changing the advanced system settings
- Power** For changing the advanced power management (APM) configuration
- Boot** For changing the system boot configuration
- Tools** For changing the system tools configuration
- Exit** For selecting the exit options and loading default settings

To select an item on the menu bar, press the right or left arrow key on the keyboard until the desired item is highlighted.



- The BIOS setup screens shown in this chapter are for reference purposes only, and may not exactly match what you see on your screen.
- Visit the ASUS website (www.asus.com) to download the latest BIOS information.

2.2.3 Legend bar

At the bottom of the Setup screen is a legend bar. The keys in the legend bar allow you to navigate through the various setup menus. The following table lists the keys found in the legend bar with their corresponding functions.

Navigation Key	Function
<F1>	Displays the General Help screen
<F5>	Loads setup default values
<Esc>	Exits the BIOS setup or returns to the main menu from a sub-menu
Left or Right arrow	Selects the menu item to the left or right
Up or Down arrow	Moves the highlight up or down between fields
Page Down or – (minus)	Scrolls backward through the values for the highlighted field
Page Up or + (plus)	Scrolls forward through the values for the highlighted field
<Enter>	Brings up a selection menu for the highlighted field
<F10>	Saves changes and exit

2.2.4 Menu items

The highlighted item on the menu bar displays the specific items for that menu. For example, selecting Main shows the Main menu items.

The other items (Advanced, Power, Boot, and Exit) on the menu bar have their respective menu items.

2.2.5 Sub-menu items

A solid triangle before each item on any menu screen means that the item has a sub-menu. To display the sub-menu, select the item and press <Enter>.

2.2.6 Configuration fields

These fields show the values for the menu items. If an item is user-configurable, you can change the value of the field opposite the item. You cannot select an item that is not user-configurable.

A configurable field is enclosed in brackets, and is highlighted when selected. To change the value of a field, select it then press <Enter> to display a list of options. Refer to “2.2.7 Pop-up window.”

2.2.7 Pop-up window

Select a menu item then press <Enter> to display a pop-up window with the configuration options for that item.

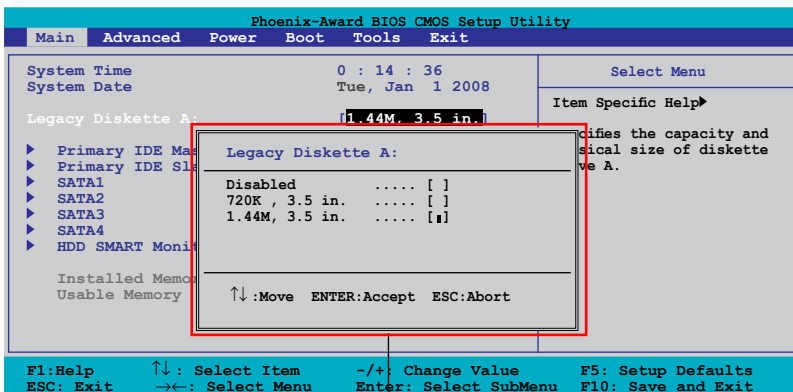

Pop-up menu

2.2.8 General help

At the top right corner of the menu screen is a brief description of the selected item.

2.3 Main menu

When you enter the BIOS Setup program, the Main menu screen appears, giving you an overview of the basic system information.



Refer to section “2.2.1 BIOS menu screen” for information on the menu screen items and how to navigate through them.

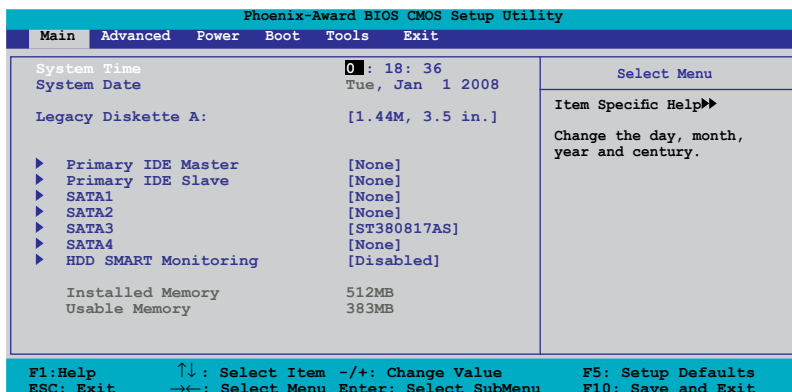

2.3.1 System Time [xx:xx:xx]

Allows you to set the system time.

2.3.2 System Date [Day xx/xx/xxxx]

Allows you to set the system date.

2.3.3 Legacy Diskette A [1.44M, 3.5 in.]

Sets the type of floppy drive installed. Configuration options: [Disabled]
[720K , 3.5 in.] [1.44M, 3.5 in.]

2.3.4 Primary IDE Master/Slave

While entering Setup, the BIOS automatically detects the presence of IDE devices. There is a separate sub-menu for each IDE device. Select a device item then press <Enter> to display the IDE device information.

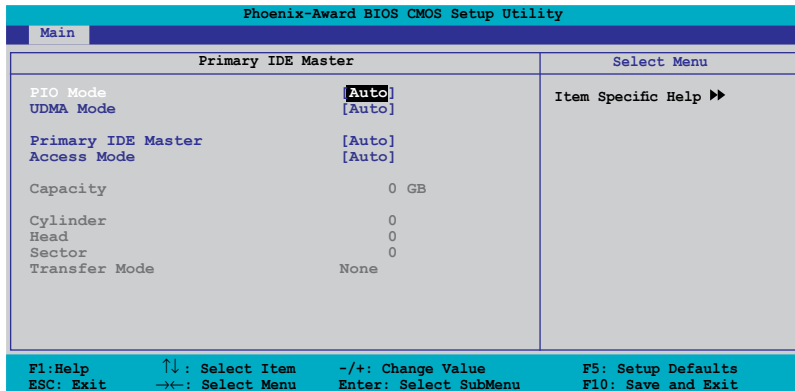

The BIOS automatically detects the values opposite the dimmed items (Capacity, Cylinder, Head, Sector and Transfer Mode). These values are not user-configurable. These items show N/A if no IDE device is installed in the system.

PIO Mode [Auto]

Sets the PIO mode for the IDE device. Configuration options: [Auto] [Mode 0] [Mode 1] [Mode 2] [Mode 3] [Mode 4]

UDMA Mode [Auto]

Disables or sets the UDMA mode. Configuration options: [Disabled] [Auto]

Primary IDE Master/Slave [Auto]

Select [Auto] to automatically detect an IDE hard disk drive. If automatic detection is successful, the BIOS automatically fills in the correct values for the remaining fields on this sub-menu. If the hard disk was already formatted on a previous system, the setup BIOS may detect incorrect parameters. Select [Manual] to manually enter the IDE hard disk drive parameters. If no drive is installed select [None]. Configuration options: [None] [Auto] [Manual]

Access Mode [Auto]

The default [Auto] allows automatic detection of an IDE hard disk drive. Select [CHS] for this item if you set the Primary IDE Master/Slave to [Manual]. Configuration options: [CHS] [LBA] [Large] [Auto]



Before attempting to configure a hard disk drive, ensure that you have the correct configuration information supplied by the drive manufacturer. Incorrect settings may cause the system to fail to recognize the installed hard disk.

Capacity

Displays the auto-detected hard disk capacity. This item is not configurable.

Cylinder

Shows the number of the hard disk cylinders. This item is not configurable.

Head

Shows the number of the hard disk read/write heads. This item is not configurable.

Sector

Shows the number of sectors per track. This item is not configurable.

Transfer Mode

Shows the Transfer mode. This item is not configurable.



After entering the IDE hard disk drive information into BIOS, use a disk utility, such as FDISK, to partition and format new IDE hard disk drives. This is necessary so that you can write or read data from the hard disk. Ensure to set the partition of the Primary IDE hard disk drives to active.

2.3.5 SATA 1-4

While entering Setup, the BIOS automatically detects the presence of Serial ATA devices. There is a separate sub-menu for each SATA device. Select a device item then press <Enter> to display the SATA device information.

Phoenix-Award BIOS CMOS Setup Utility	
Main	
SATA 1	Select Menu
Extended IDE Drive	[Auto]
Access Mode	[Auto]
Capacity	0 MB
Cylinder	0
Head	0
Landing Zone	0
Sector	0
Item Specific Help ►► Selects the type of fixed disk connected to the system.	
F1: Help	↑↓: Select Item
ESC: Exit	-/+ : Change Value
	→←: Select Menu
	Enter: Select SubMenu
	F5: Setup Defaults
	F10: Save and Exit

The BIOS automatically detects the values opposite the dimmed items (Capacity, Cylinder, Head, Precomp, Landing Zone and Sector). These values are not user-configurable. These items show 0 if no SATA device is installed in the system.

Extended IDE Drive [Auto]

Selects the type of fixed disk connected to the system.

Configuration options: [None] [Auto]

Access Mode [Auto]

Sets the sector addressing mode. Configuration options: [Large] [Auto]



Before attempting to configure a hard disk drive, ensure that you have the correct configuration information supplied by the drive manufacturer. Incorrect settings may cause the system to fail to recognize the installed hard disk.

Capacity

Displays the auto-detected hard disk capacity. This item is not configurable.

Cylinder

Shows the number of the hard disk cylinders. This item is not configurable.

Head

Shows the number of the hard disk read/write heads. This item is not configurable.

Landing Zone

Shows the number of landing zone per track. This item is not configurable.

Sector

Shows the number of sectors per track. This item is not configurable.



After entering the IDE hard disk drive information into BIOS, use a disk utility, such as FDISK, to partition and format new IDE hard disk drives. This is necessary so that you can write or read data from the hard disk. Ensure to set the partition of the Primary IDE hard disk drives to active.

2.3.6 HDD SMART Monitoring [Disabled]

Allows you to enable or disable the HDD Self-Monitoring Analysis and Reporting Technology (SMART) feature. Configuration options: [Disabled] [Enabled]

2.3.7 Installed Memory [xxx MB]

Shows the size of installed memory.

2.3.8 Usable Memory [XXX MB]

Shows the size of usable memory.

2.4 Advanced menu

The Advanced menu items allow you to change the settings for the CPU and other system devices.



Take caution when changing the settings of the Advanced menu items. Incorrect field values can cause the system to malfunction.

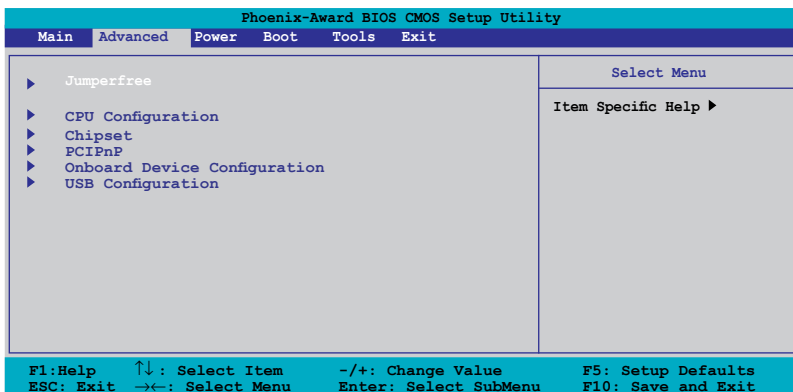

2.4.1 JumperFree

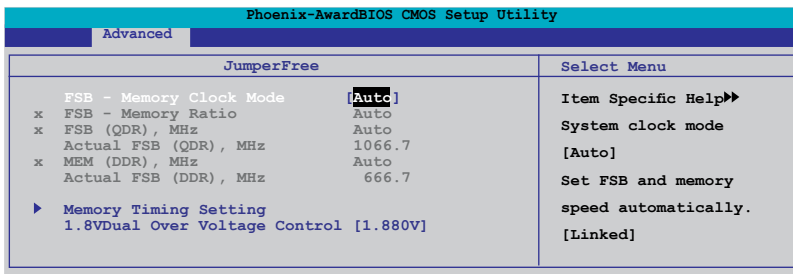

FSB - Memory Clock Mode [Auto]

Allows you to select the FSB memory clock mode. Configuration options: [Auto] [Linked] [Unlinked]

FSB - Memory Ratio [Auto]

Allows you to select the FSB memory ratio. This item becomes user-configurable when the **FSB - Memory Clock Mode** item is set to [Linked]. Configuration options: [Auto] [1:1] [5:4] [3:2] [Sync Mode]

FSB (QDR), MHz [Auto]

Allows you to adjust CPU FSB frequency from 400 to 2000. You may enter a new value or use +/- keys to adjust. This item becomes user-configurable when the **FSB - Memory Clock Mode** item is set to [Linked] or [Unlinked].



The Actual FSB (QDR) reflects the actual frequency that takes effect on a reboot.

MEM (DDR), MHz [Auto]

Allows you to adjust the memory frequency from 400 to 1400. You may enter a new value or use +/- keys to adjust. This item becomes user-configurable when the **FSB - Memory Clock Mode** item is set to [Unlinked].



The actual MEM (DDR) reflects the actual frequency that takes effect on a reboot.

Memory Timing Setting

Phoenix-Award BIOS CMOS Setup Utility	
Advanced	
Memory Timing Setting	Select Menu
Memory Timing Setting	[Optimal]
X tCL (CAS Latency)	Auto
X tRCD	Auto
X tRP	Auto
X tRAS	Auto
X Command Per Clock (CMD)	Auto
** Advanced Memory Setting **	
X rRRD	Auto
X tRC	Auto
X tWR	Auto
X tWTR	Auto
X tREF	Auto
	Item Specific Help >>>
	Select [Expert] to enter timings manually

Memory Timing Setting [Optimal]

Allows you to set the memory timing setting. Configuration options: [Optimal] [Expert]



The following items become user-configurable when the **Memory Timing Setting** item is set to [Expert].

tCL (CAS Latency) [Auto]

Allows you to set tCL (CAS Latency). Configuration options: [Auto] [1] [2] [3] [4] [5] [6].

tRCD [Auto]

Allows you to set RAS to CAS delay for a RD/WR command to the same bank. Configuration options: [Auto] [1] [2] [3] [4] [5] [6] [7]

tRP [Auto]

Allows you to set the row precharge time Precharge-to-Active or Auto-Refresh of the same bank. Configuration options: [Auto] [1] [2] [3] [4] [5] [6] [7]

tRAS [Auto]

Allows you set the minimum RAS active time. Configuration options: [Auto] [1] [2] [3] [4] [5] [6] [7]...[31]

Command Per Clock (CMD) [Auto]

Allows you to command timing setting (per clock unit). Configuration options: [Auto] [1 clock] [2 clock]

Advanced Memory Settings

tRRD [Auto]

Allows you to set tRRD. Configuration options: [Auto] [1] [2] [3] [4] [5] [6]...[15].

tRC [Auto]

Allows you set the RAS to RAS or auto refresh time of the same bank. Configuration options: [Auto] [1] [2] [3] [4] [5] [6] [7]...[31]

tWR [Auto]

Allows you set the tWR. Configuration options: [Auto] [1] [2] [3] [4] [5] [6]

tWTR [Auto]

Allows you set the tWTR. Configuration options: [Auto] [1] [2] [3] [4] [5] [6] [7]...[15]

tREF [Auto]

Allows you set the tREF. Configuration options: [Auto] [1] [2]

1.8VDual Over Voltage Control [1.880V]

Allows you to adjust +1.8V dual over voltage. Configuration options: [1.880V] [1.920V] [1.962V] [2.002V] [2.057V] [2.095V] [2.139V] [2.179V]

2.4.2 CPU Configuration

Phoenix-Award BIOS CMOS Setup Utility		
Advanced		
CPU Configuration		Select Menu
CPU Type	Inter(R) Core(TM)2 CPU 6300 @ 1.86GHz	Item Specific Help ►►
CPU Speed	1.86GHz	Thermal Monitor 1 (On die throttling)
Cache RAM	2048K	ThermalMonitor 2 Ratio & VID transition)
CPU Internal Thermal Control	[Auto]	
Limit CPUID MaxVal	[Disabled]	
Enhanced C1 (C1E)	[Disabled]	
Execute Disable Bit	[Enabled]	
Virtualization Technology	[Enabled]	
CPU Multiplier	[7 x]	
Enhanced Intel SpeedStep(tm) Tech.	[Enabled]	

CPU Internal Thermal Control [Auto]

Enables or disables the CPU internal thermal control.

Configuration options: [Auto] [Disabled]

Limit CPUID MaxVal [Disabled]

Enables or disables the Limit CPUID MaxVal technology.

Configuration options: [Disabled] [Enabled]

Enhanced C1 (C1E) [Disabled]

Enables or disables the Enhanced C1 (C1E) technology. The process lowers the core to bus ratio and VID when physical process enters an enhance C1 state.

Configuration options: [Enable] [Disabled]

Execute Disable Bit [Enabled]

Enables or disables the processor's XD bit feature.

Configuration options: [Enabled] [Disabled]

Virtualization Technology [Enabled]

Enables or disables the Virtualization technology. When enabled, a VMM can utilize the additional hardware capabilities provided by Vanderpool Technology.

Configuration options: [Enable] [Disabled]

CPU Multiplier [7X]

Allows you to set the CPU multiplier. Configuration options: [Min.=0.0] [Max.=50.0]

Enhanced Intel SpeedStep(tm) Tech [Enabled]

Enables or disables the Enhanced Intel SpeedStep technology to adjust CPU speed according to CPU workload. Configuration options: [Disabled] [Enabled]

2.4.3 Chipset

Phoenix-Award BIOS CMOS Setup Utility	
Advanced	
Chipset	Select Menu
▶ Spread Spectrum Control Frame Buffer Size [128MB] Primary Display Adapter [PCI-E]	Item Specific Help ▶▶

Spread Spectrum Control

Phoenix-Award BIOS CMOS Setup Utility	
Advanced	
Spread Spectrum Control	Select Menu
CPU Spread Spectrum [Disabled] SATA Spread Spectrum [Disabled] PCIE Spread Spectrum [Disabled]	Item Specific Help ▶▶▶

CPU/SATA/PCIE Spread Spectrum [Disabled]
Allows you to enable or disabled CPU/SATA/PCIE spread spectrum.
Configuration options: [Disabled] [Enabled]

Frame Buffer Size [128M]

Allows you to set the frame buffer size. Configuration options: [16M] [32M] [64M] [128M] [256M]

Primary Display Adapter [PCI-E]

Allows you to select the graphics controller to use as the primary boot device.
Configuration options: [PCI] [Onboard] [PCI-E]

2.4.4 PCIPnP

Phoenix-Award BIOS CMOS Setup Utility	
Advanced	
PCIPnP	Select Menu
Plug & Play O/S [No]	Item Specific Help ▶▶

Plug & Play O/S [No]

When set to [No], the BIOS configures all the devices in the system. When set to [Yes] and if you install a Plug and Play operating system, the operating system configures the Plug and Play devices not required for boot.
Configuration options: [No] [Yes]

2.4.5 Onboard Device Configuration

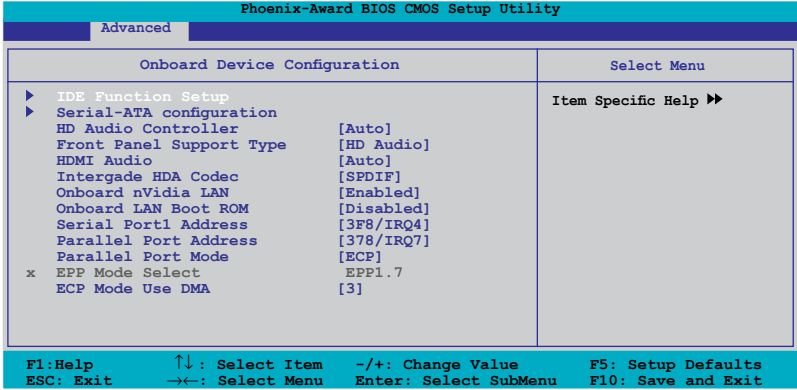

IDE Function Setup

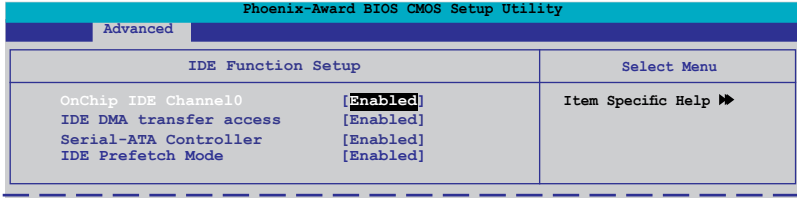

OnChip IDE Channel 0 [Enabled]

Allows you to enable or disable the OnChip IDE channel 0 controller.
 Configuration options: [Disabled] [Enabled]

IDE DAM transfer access [Enabled]

Allows you to enable or disable IDE DMA transfer access .
 Configuration options: [Disabled] [Enabled]

Serial-ATA Controller [Enabled]

Allows you to enable or disable the Serial-ATA controller.
 Configuration options: [Disabled] [Enabled]

IDE Prefetch Mode [Enabled]

Allows you to enable or disable the IDE prefetch mode.
 Configuration options: [Disabled] [Enabled]

Serial-ATA configuration

Phoenix-Award BIOS CMOS Setup Utility		
Advanced		
Serial-ATA configuration		Select Menu
SATA Operation Mode	[IDE]	Item Specific Help ▶▶
X SATA 1	Disabled	
X SATA 2	Disabled	
X SATA 3	Disabled	
X SATA 4	Disabled	

SATA Operation Mode [IDE]

Allows you to select SATA operation mode. Configuration options: [IDE] [RAID] [AHCI].



The following items become user-configurable when the **SATA Operation Mode** item is set to [RAID].

SATA 1 / 2 / 3 / 4 [Disabled]

Allows you to enable or disable SATA 1 / 2 / 3 / 4. Configuration options: [Disable] [Enabled]

HD Audio Controller [Auto]

Allows you to enable or disable the HD Audio controller.
Configuration options: [Auto] [Disabled]

Front Panel Support Type [HD Audio]

Allows you to set the front panel audio connector (AAFP) mode to legacy AC`97 or high-definition audio depending on the audio standard that the front panel audio module supports. Configuration options: [AC97] [HD Audio]

HDMI Audio [Auto]

Allows you to enable or disable the HDMI Audio.
Configuration options: [Auto] [Disabled]

Intergade HDA Codec [SPDIF]

Allows you to select the intergade HDA Codec.
Configuration options: [HDMI] [SPDIF]

Onboard nVidia LAN [Enabled]

Allows you to enable or disable the onboard nVidia LAN device support.
Configuration options: [Disabled] [Enabled]

OnBoard LAN Boot ROM [Disabled]

Allows you to enable or disable the onboard LAN boot ROM.

Configuration options: [Enabled] [Disabled]

Serial Port1 Address [3F8/IRQ4]

Allows you to select the Serial Port1 base address. Configuration options:

[Disabled] [3F8/IRQ4] [2F8/IRQ3] [3E8/IRQ4] [2E8/IRQ3] [Auto]

Parallel Port Address [378/IRQ7]

Allows you to select the Parallel Port address. Configuration options: [Disabled]

[378/IRQ7] [278/IRQ5] [3BC/IRQ7]

Parallel Port Mode [ECP]

Allows you to select the Parallel Port mode. Configuration options: [SPP] [EPP]

[ECP] [ECP+EPP] [Normal]



The “EPP Mode Select” item becomes user-configurable when the **Parallel Port Mode** item is set to [EPP] or [ECP+EPP]

EPP Mode Select [EPP1.7]

Allows you to select EPP mode. Configuration options: [EPP1.9] [EPP1.7]



The “ECP Mode Use DMA” item becomes user-configurable when the **Parallel Port Mode** item is set to [ECP] or [ECP+EPP]

ECP Mode Use DMA [3]

Allows you to select ECP mode use DMA. Configuration options: [1] [3]

2.4.6 USB Configuration

The items in this menu allows you to change the USB-related features. Select an item then press <Enter> to display the configuration options.

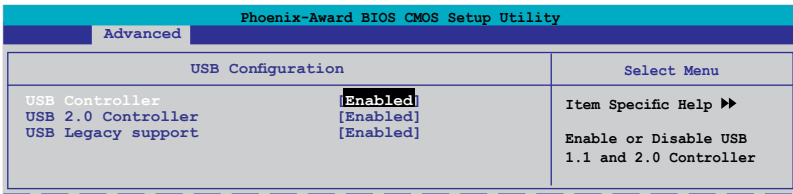

USB Controller [Enabled]

Allows you to enable or disable the USB controller.
Configuration options: [Disabled] [Enabled]

USB 2.0 Controller [Enabled]

Allows you to enable or disable the USB 2.0 controller.
Configuration options: [Disabled] [Enabled]

USB Legacy Support [Enabled]

Allows you to enable or disable support for USB devices on legacy operating systems (OS). Configuration options: [Disabled] [Enabled]

2.5 Power menu

The Power menu items allow you to change the settings for the Advanced Configuration and Power Interface (ACPI) and the Advanced Power Management (APM). Select an item then press <Enter> to display the configuration options.

Phoenix-Award BIOS CMOS Setup Utility					
Main	Advanced	Power	Boot	Tools	Exit
ACPI Suspend Type [S1&S3] ACPI APIC support Enabled ▶ APM Configuration ▶ HardWare Monitor		Select Menu Item Specific Help Select the ACPI state used for System Suspend.			
F1: Help ↑↓: Select Item -/+ : Change Value F5: Setup Defaults ESC: Exit →←: Select Menu Enter: Select SubMenu F10: Save and Exit					

2.5.1 ACPI Suspend Type [S1&S3]

Allows you to select the Advanced Configuration and Power Interface (ACPI) state to be used for system suspend. Configuration options: [S1(POS)] [S3(STR)] [S1&S3]

2.5.2 ACPI APIC Support [Enabled]

Allows you to enable or disable the Advanced Configuration and Power Interface (ACPI) support in the Application-Specific Integrated Circuit (ASIC). When set to Enabled, the ACPI APIC table pointer is included in the RSDT pointer list. Configuration options: [Disabled] [Enabled]

2.5.3 APM Configuration

Phoenix-Award BIOS CMOS Setup Utility		
Power		
APM Configuration		Select Menu
Restore on AC Power Loss [Power-Off] PWR Button < 4 secs [Instant-Off] Power Up On PCI/PCIE Devices [Disabled] Power On By External Modems [Disabled] Power On by RTC Alarm [Disabled] x Date (of Month) Alarm 0 x Alarm Time (hh:mm) 0 : 0 : 0 HPET Support [Enabled] Power On By Keyboard [Disabled] Power On By PS/2 Mouse [Enabled]		Item Specific Help Press [Enter] to select whether or not to restart the system after AC power loss
F1: Help ↑↓: Select Item -/+ : Change Value F5: Setup Defaults ESC: Exit →←: Select Menu Enter: Select SubMenu F10: Save and Exit		

Restore on AC Power Loss [Power Off]

When set to Power Off, the system goes into off state after an AC power loss. When set to Power On, the system goes on after an AC power loss. When set to Configuration options: [Power Off] [Power On] [Last State]

PWR Button < 4 secs [Instant-Off]

Allows you to set the event after the power button is pressed for more than 4 seconds. Configuration options: [Suspend] [Instant-Off]

Power Up On PCI/PCIE Devices [Disabled]

Allows you to enable or disable the PME to wake up from S5 by PCI/PCIE devices & NV Onboard LAN. Configuration options: [Disabled] [Enabled]

Power On By External Modems [Disabled]

This allows either settings of [Enabled] or [Disabled] for powering up the computer when the external modem receives a call while the computer is in Soft-off mode. Configuration options: [Disabled] [Enabled]



The computer cannot receive or transmit data until the computer and applications are fully running. Thus, connection cannot be made on the first try. Turning an external modem off and then back on while the computer is off causes an initialization string that turns the system power on.

Power On By RTC Alarm [Disabled]

Allows you to enable or disable the power on by RTC alarm. Configuration options: [Disabled] [Enabled]



The following items become user-configurable when the **Power On By RTC Alarm** item is set to [Enabled].

To set the date of alarm, highlight this item and press <Enter> to display the Date of Month Alarm pop-up menu. Key-in a value within the specified range then press <Enter>. Configuration options: [Min=0] [Max=31]

Alarm Time (hh:mm) [0:0:0]

To set the time of alarm:

1. Highlight this item and press <Enter> to display a pop-up menu for the hour field.
2. Key-in a value (Min=0, Max=23), then press <Enter>.
3. Press <TAB> to move to the minutes field then press <Enter>.
4. Key-in a minute value (Min=0, Max=59), then press <Enter>.
5. Press <TAB> to move to the seconds field then press <Enter>.
6. Key-in a value (Min=0, Max=59), then press <Enter>.

HPET Support [Enabled]

Allows you to enable or disable HPET (Hardware Precision Efficient Timer) support. The HPET support increases the performance of Vista Multimedia player.
Configuration options: [Disabled] [Enabled]

Power On By Keyboard [Disabled]

Allows you to set power on by keyboard. Configuration options: [Disabled] [Ctrl-ESC] [Space Bar] [Power Key]

Power On By PS/2 Mouse [Disabled]

Allows you to enable or disable PS/2 mouse power on the system.
Configuration options: [Disabled] [Enabled]

2.5.4 Hardware Monitor

The items in this sub-menu displays the hardware monitor values automatically detected by the BIOS. It also allows you to change CPU Q-Fan feature-related parameters. Select an item then press <Enter> to display the configuration options.

Phoenix-Award BIOS CMOS Setup Utility		
Power		
Hardware Monitor		Select Menu
Q-Fan Function	[Disabled]	Item Specific Help ►►
x CPU Target Temperature	[60°C/140°C]	Enable or Disable Q FAN function
CPU Temperature	48°C/93°F	
MB Temperature	37°C/98°F	
CPU Fan Speed	2909 RPM	
Chassis Fan Speed	0 RPM	
Vcore	[1.36V]	
Vcc 12V	[12.14V]	
Vcc 3.3V	[3.18V]	
Vcc 5V	[5.05V]	
CPU Fan Speed Warning	[600 RPM]	

Q-Fan Function [Disabled]

Allows you to enable or disable the Q-Fan function.

Configuration options: [Disabled] [Enabled]



The following item becomes user-configurable when the **Q-Fan Function** item is set to [Enabled].

CPU Target Temperature [60 °C / 140 °F]

Allows you to adjust the CPU target temperature. Configuration options: [10 °C / 50°F] [15 °C / 59 °F] [20 °C / 68 °F]...[85 °C / 185 °F].

CPU/MB Temperature

The onboard hardware monitor automatically detects and displays the motherboard and CPU temperatures. These items are not user-configurable.

CPU/Chassis Fan Speed [xxxxRPM]

The onboard hardware monitor automatically detects and displays the CPU, and Chassis fan speeds in rotations per minute (RPM). If any of the fans is not connected to the motherboard, the field shows 0. These items are not user-configurable.

Vcore, Vcc 12, Vcc 3.3V, 5V

The onboard hardware monitor automatically detects the voltage output through the onboard voltage regulators. Configuration options: [xxx] [Ignored]

CPU Fan Speed warning [600 RPM]

Sets the CPU fan speed warning feature. Configuration options: [Disabled] [600RPM] [1200RPM] [1600RPM]

2.6 Boot menu

The Boot menu items allow you to change the system boot options. Select an item then press <Enter> to display the sub-menu.

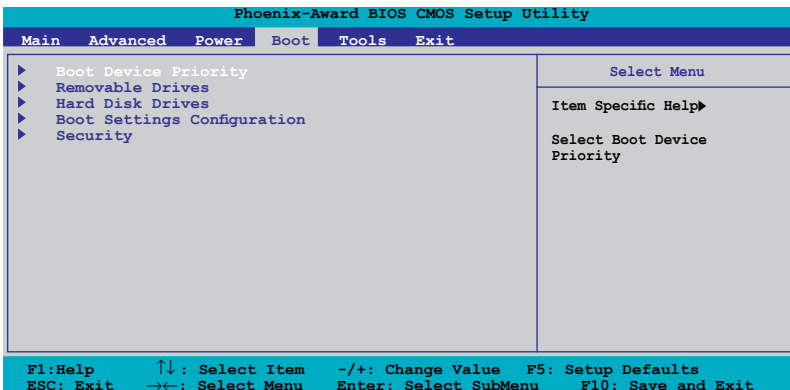

2.6.1 Boot Device Priority

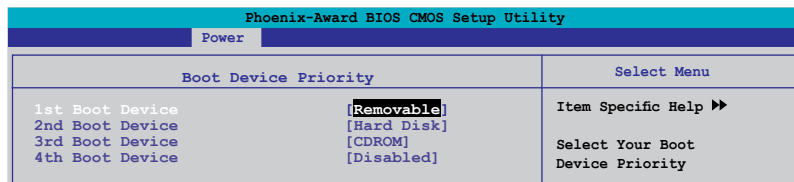

1st ~ 4th Boot Device [Removable]

These items specify the boot device priority sequence from the available devices. The number of device items that appears on the screen depends on the number of devices installed in the system.

Configuration options: [Removable] [Hard Disk] [CDROM] [Disabled]

2.6.2 Removable Drives

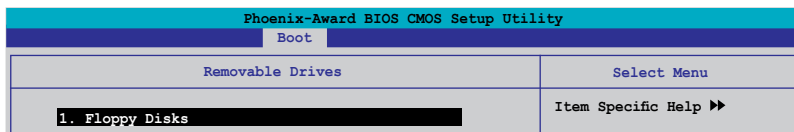

1. Floppy Disks

Allows you to assign a removable drive attached to the system.

2.6.3 Hard Disk Drives

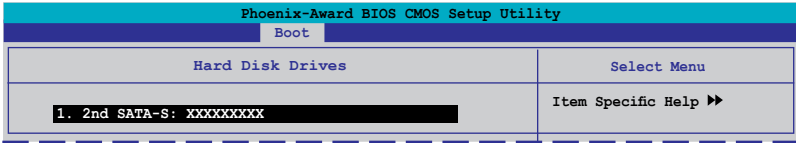

1. 2nd SATA-S; xxxxxxxx

Allows you to assign a hard disk drive attached to the system.

2.6.4 Boot Settings Configuration

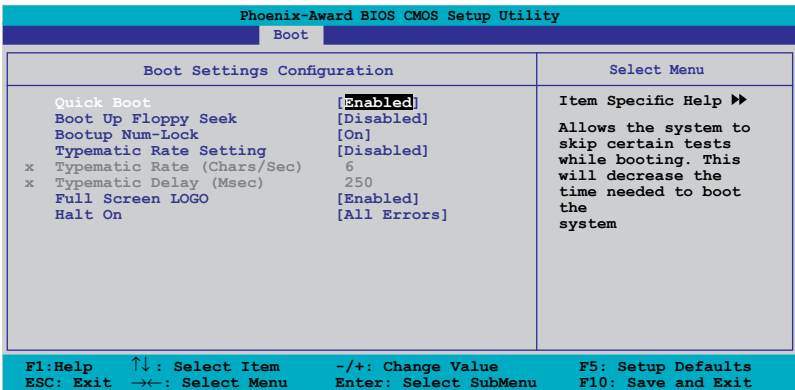

Quick Boot [Enabled]

Allows you to enable or disable the system quick boot feature. When Enabled, the system skips certain tests while booting. Configuration options: [Disabled] [Enabled]

Boot Up Floppy Seek [Disabled]

Enables or disables the chassis open status feature. Setting to Enabled, clears the chassis open status. Configuration options: [Disabled] [Enabled]

Bootup Num-Lock [On]

Allows you to select the power-on state for the NumLock. Configuration options: [Off] [On]

Typematic Rate Setting [Disabled]

Allows you to set the keystroke rate. Enable this item to configure the Typematic Rate (Chars/Sec) and the Typematic Delay (Msec).

Configuration options: [Disabled] [Enabled]



The items Typematic Rate (Chars/Sec) and Typematic Delay (Msec) become user-configurable only when the item Typematic Rate Setting is enabled.

Typematic Rate (Chars/Sec) [6]

Allows you to select the rate at which a character repeats when you hold a key. Configuration options: [6] [8] [10] [12] [15] [20] [24] [30]

Typematic Delay (Msec) [250]

Allows you to set the delay before keystrokes begin to repeat. Configuration options: [250] [500] [750] [1000]

Full Screen LOGO [Enabled]

Allows you to enable or disable the full screen logo display feature.

Configuration options: [Disabled] [Enabled]



Ensure that the above item is set to [Enabled] if you want to use the ASUS MyLogo2™ feature.

Halt On [All Errors]

Allows you to error report type. Configuration options: [All Errors] [No Errors] [All, But Keyboard] [All, But Diskette] [All, But Disk/Key]

2.6.5 Security

Phoenix-Award BIOS CMOS Setup Utility		
Boot		
Security		Select Menu
Supervisor Password	Clear	Item Specific Help ►►
User Password	Clear	
Password Check	[Setup]	

Supervisor Password User Password

These fields allow you to set passwords:

To set a password:

1. Select an item then press <Enter>.
2. Type in a password using a combination of a maximum of eight (8) alphanumeric characters, then press <Enter>.
3. When prompted, confirm the password by typing the exact characters again, then press <Enter>. The password field setting is changed to Set.

To clear the password:

1. Select the password field and press <Enter> twice. The following message appears:



2. Press any key to continue. The password field setting is changed to Clear.

A note about passwords

The Supervisor password is required to enter the BIOS Setup program preventing unauthorized access. The User password is required to boot the system preventing unauthorized use.

Forgot your password?

If you forget your password, you can clear it by erasing the CMOS Real Time Clock (RTC) RAM. The RAM data containing the password information is powered by the onboard button cell battery. If you need to erase the CMOS RAM, refer to section "1.9 Jumpers" for instructions.

Password Check

This field requires you to enter the password before entering the BIOS setup or the system. Select [Setup] to require the password before entering the BIOS Setup. Select [System] to require the password before entering the system. Configuration options: [Setup] [System]

2.7 Tools menu

The Tools menu items allow you to configure options for special functions. Select an item then press <Enter> to display the sub-menu.

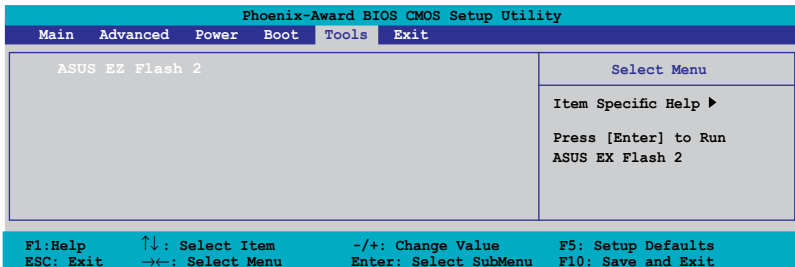

ASUS EZ Flash 2

Allows you to run ASUS EZ Flash 2. When you press <Enter>, a confirmation message appears. Use the left/right arrow key to select between [Yes] or [No], then press <Enter> to confirm your choice. Please see page 2-6, section 2.1.3 for details.

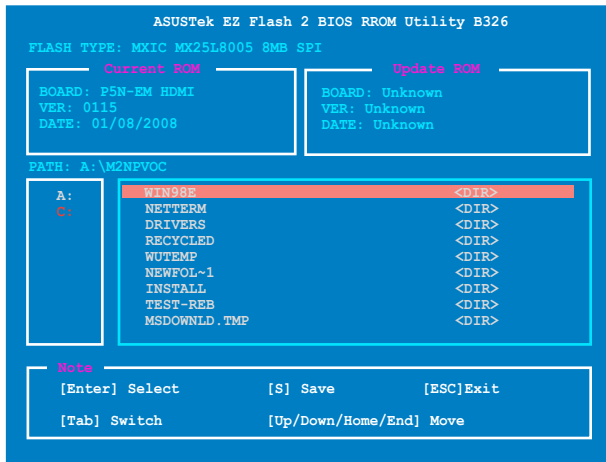

2.8 Exit menu

The Exit menu items allow you to load the optimal or failsafe default values for the BIOS items, and save or discard your changes to the BIOS items.

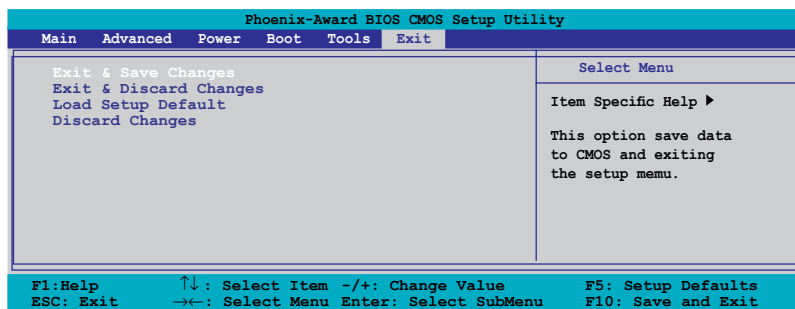

Pressing <Esc> does not immediately exit this menu. Select one of the options from this menu or <F10> from the legend bar to exit.

Exit & Save Changes

Once you are finished making your selections, choose this option from the Exit menu to ensure the values you selected are saved to the CMOS RAM. An onboard backup battery sustains the CMOS RAM so it stays on even when the PC is turned off. When you select this option, a confirmation window appears. Select YES to save changes and exit.



If you attempt to exit the Setup program without saving your changes, the program prompts you with a message asking if you want to save your changes before exiting. Press <Enter> to save the changes while exiting.

Exit & Discard Changes

Select this option only if you do not want to save the changes that you made to the Setup program. If you made changes to fields other than System Date, System Time, and Password, the BIOS asks for a confirmation before exiting.

Load Setup Defaults

This option allows you to load the default values for each of the parameters on the Setup menus. When you select this option or if you press <F5>, a confirmation window appears. Select YES to load default values. Select Exit & Save Changes or make other changes before saving the values to the non-volatile RAM.

Discard Changes

This option allows you to discard the selections you made and restore the previously saved values. After selecting this option, a confirmation appears. Select YES to discard any changes and load the previously saved values.

This chapter describes the contents of the support CD that comes with the motherboard package.

3 Software support

3.1 Installing an operating system

This motherboard supports Windows® 32-bit XP / 32-bit Vista / 64-bit XP / 64-bit Vista Operating Systems (OS). Always install the latest OS version and corresponding updates to maximize the features of your hardware.



- Motherboard settings and hardware options vary. Use the setup procedures presented in this chapter for reference only. Refer to your OS documentation for detailed information.
- Ensure that you install the Windows® XP Service Pack 1 or later versions before installing the drivers for better compatibility and system stability.

3.2 Support CD information

The support CD that came with the motherboard package contains the drivers, software applications, and utilities that you can install to avail all motherboard features.



The contents of the support CD are subject to change at any time without notice. Visit the ASUS website(www.asus.com) for updates.

3.2.1 Running the support CD

Place the support CD to the optical drive. The CD automatically displays the Drivers menu if Autorun is enabled in your computer.

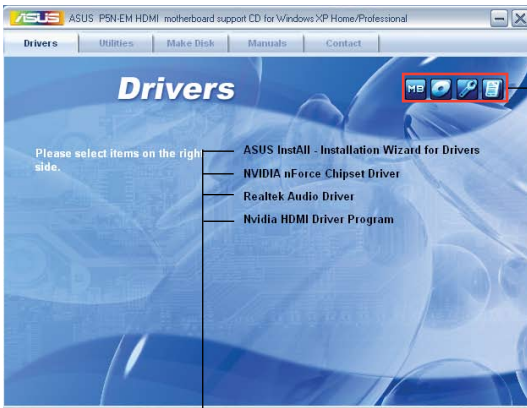

Click an icon to display support CD/motherboard information

Click an item to install



If Autorun is NOT enabled in your computer, browse the contents of the support CD to locate the file ASSETUP.EXE from the BIN folder. Double-click the ASSETUP.EXE to run the CD.

3.2.2 Drivers menu

The drivers menu shows the available device drivers if the system detects installed devices. Install the necessary drivers to activate the devices.

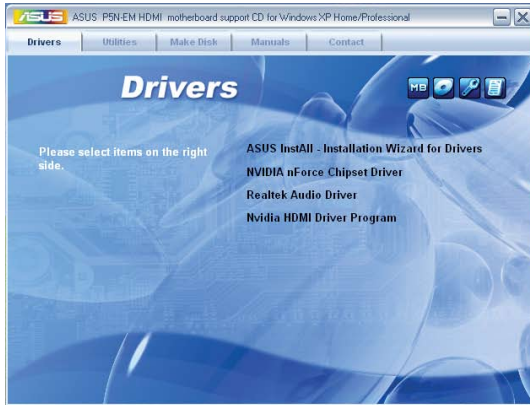

ASUS InstAll-Drivers Installation Wizard

Installs the ASUS InstAll-Drivers Installation Wizard.

NVIDIA nForce Chipset Driver

Install the NVIDIA nForce chipset driver.

Realtek Audio Driver

Install the Realtek audio driver.

NVIDIA HDMI Driver Program

Installs the NVIDIA® HDMI Driver program.



The screen display and drivers option may not be the same for different operating system versions.

3.2.3 Utilities menu

The Utilities menu shows the applications and other software that the motherboard supports.

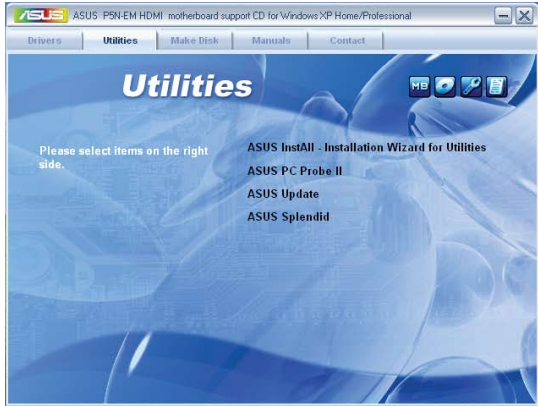

ASUS InstAll - Installation Wizard for Utilities

Install all of the utilities through the Installation Wizard.

ASUS PC Probe II

This smart utility monitors the fan speed, CPU temperature, and system voltages, and alerts you of any detected problems. This utility helps you keep your computer in healthy operating condition.

ASUS Update

The ASUS Update utility allows you to update the motherboard BIOS in a Windows® environment. This utility requires an Internet connection either through a network or an Internet Service Provider (ISP).

ASUS Splendid

Install the ASUS Splendid.



The screen display and utilities option may not be the same for different operating system versions.

3.2.4 Make Disk menu

The Make Disk menu allows you to make a RAID driver disk.

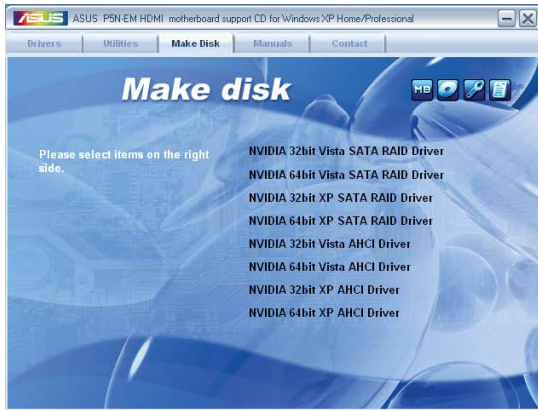

NVIDIA 32/64 bit Vista SATA RAID Driver

Allows you to create the NVIDIA® 32/64-bit Vista SATA RAID disk.

NVIDIA 32/64 bit XP SATA RAID Driver

Allows you to create the NVIDIA® 32/64-bit XP SATA RAID disk.

NVIDIA 32/64 bit Vista AHCI Driver

Allows you to create the NVIDIA® 32/64-bit Vista AHCI disk.

NVIDIA 32/64 bit XP AHCI Driver

Allows you to create the NVIDIA® 32/64-bit XP AHCI disk.

3.2.5 Manual menu

The Manual menu contains a list of supplementary user manuals. Click an item to open the folder of the user manual.



Most user manual files are in Portable Document Format (PDF). Install the Adobe® Acrobat® Reader from the Utilities menu before opening a user manual file.



NVIDIA® SATA RAID User's Manual

Allows you to open the NVIDIA® SATA RAID user's manual.

3.2.6 ASUS Contact information

Click the Contact tab to display the ASUS contact information. You can also find this information on the inside front cover of this user guide.

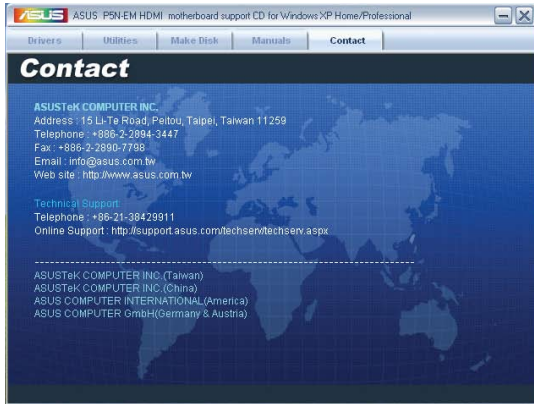

3.2.7 Other information

The icons on the top right corner of the screen give additional information on the motherboard and the contents of the support CD. Click an icon to display the specified information.

Motherboard Info

Displays the general specifications of the motherboard.

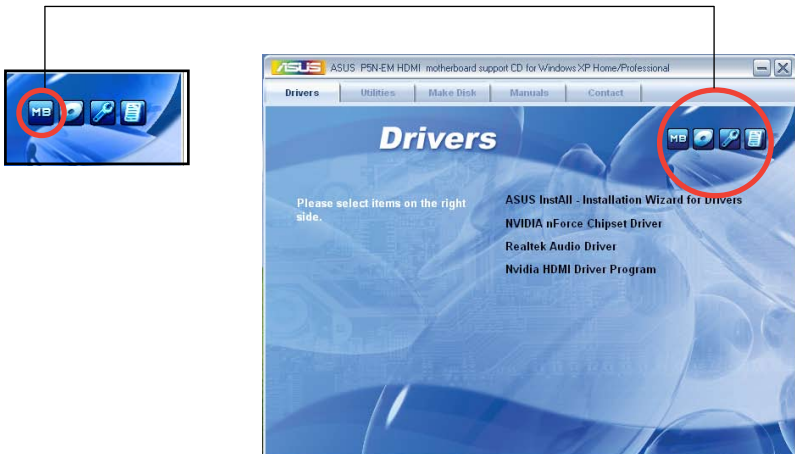

Browse this CD

Displays the support CD contents in graphical format.

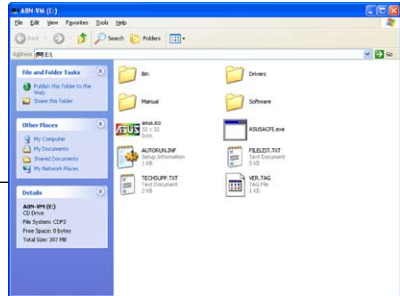
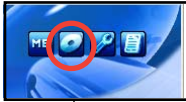

Technical Support Form

Displays the ASUS Technical Support Request Form that you have to fill out when requesting technical support.



```
ASUSTEK TECHNICAL SUPPORT REQUEST FORM
=====
ORIGINATOR: DESCRIPTION
=====
COMPANY NAME:
PHONE (AREA):
EMAIL ADDRESS:
CONTACT NAME:
FAX # (AREA):
=====
HARDWARE DESCRIPTION
=====
MOTHERBOARD: REVISION #: BIOS:#A0QLAG-
CPU BRAND: SPEED(MHz):
DRAM BRAND: SPEED(MHz): SIZE(MB):
RAM BRAND: SPEED(MHz): SIZE(MB):
CDROM BRAND: MODEL NAME: SIZE(MB):
BRACKET BRAND: MODEL NAME: SIZE(MB):
OTHER STORAGE: MODEL NAME: SIZE(MB):
=====
ADD-IN CARD DESCRIPTION (MODEL NAME/VENDOR)
=====
PCI-E SLOT 1:
PCI-E SLOT 2:
PCI-E SLOT 3:
PCI-E SLOT 4:
PCI-E SLOT 5:
PCI-E SLOT 6:
PCI-E SLOT 7:
PCI-E SLOT 8:
PCI-E SLOT 9:
PCI-E SLOT 10:
PCI-E SLOT 11:
PCI-E SLOT 12:
=====
SOFTWARE DESCRIPTION
=====
OPERATING SYSTEM:
APPLICATION SOFTWARE:
DEVICE DRIVERS:
=====
PROBLEM DESCRIPTION (WHAT PROBLEMS AND UNDER WHAT SITUATIONS)
```

Filelist

Displays the contents of the support CD and a brief description of each in text format.



```
FILE LIST for the included support software for ASB-V4/ASB-V4 CDM motherboard
=====
FILE NAME DESCRIPTION
=====
--drivers
-AMD
--Cool'n'quiet -ASUS Cool'n'quiet Driver V5.0.1 for Windows 2000.
-ASUS Cool'n'quiet Driver V5.1.2.0 for Windows XP/2003 and
-Audio
--3D1T -SOUNDMAX ADI1986A Audio driver V5.10.03.4100 For Window
--441T -SOUNDMAX ADI1986A Audio driver V5.10.03.4100 For Window
-Chipset
--32bit -NVIDIA nForce MCP51G Chipset Driver V5.0.4 for Windows
-VGA
--32bit -NVIDIA GeForce 6300 GPU driver(C53G) V8.1.1.0 for Window
-USB
--USB 2.0 driver.
-Manual
-user guide for file.
--Software
-Acrobat
-Adobe Reader V7.0.
-AFUDOS
--AFUDOS.txt -Information on how to use the AME FLASH DOS utility.
--AFUDOS.exe -Utility V2.19 for update the motherboard's AME BIOS.
-Atmboost
-ASUS at booster utility V2.00.70 for windows 2000/XP/20
-ASUSupdt
--Setup.exe -ASUS update V6.09.01 Install Program for windows 2000/XP
-efltxctk -efltxctk V6.0c runtime library for windows 2000.
-LOGO
--Default Logo Btmaps.
```

3.3 Creating a RAID driver disk

A floppy disk with the RAID driver is required when installing Windows® 32-bit XP / 32-bit Vista / 64-bit XP / 64-bit Vista OS on a hard disk drive that is included in a RAID set.

To create a RAID driver disk:

1. Place the motherboard support CD into the CD-ROM drive.
2. Select Make Disk tab.
3. From the Make Disk menu, select the RAID driver disk you want to create or browse the contents of the support CD to locate the driver disk utility.



For detailed descriptions on the NVIDIA® RAID configuration, refer to the “NVIDIA® MediaShield RAID User’s Manual” found in your motherboard support CD .

4. Insert floppy disk to floppy disk drive.
5. Follow the succeeding screen information to complete the process.
6. Write-protect the floppy disk to avoid computer virus infection.

To install the RAID driver:

1. During the OS installation, the system prompts you to press the F6 key to install third-party SCSI or RAID driver.
2. Press <F6> then insert the floppy disk with RAID driver into the floppy disk drive.
3. Follow the succeeding screen instructions to complete the installation.



Due to chipset limitation, the Serial ATA ports supported by the NVIDIA chipset does not support Serial Optical Disk Drives (Serial ODD) under DOS.

The Appendix describes the CPU features that the motherboard supports.

CPU features

A large, light gray, sans-serif letter 'A' is positioned behind the text 'CPU features', partially overlapping it.

A.1 Enhanced Intel SpeedStep® Technology (EIST)



- The motherboard comes with a BIOS file that supports EIST. You can download the latest BIOS file from the ASUS website (www.asus.com/support/download/) if you need to update the BIOS. See Chapter 2 for details.
- Visit www.intel.com for more information on the EIST feature.

A.1.1 System requirements

Before using EIST, check your system if it meets the following requirements:

- Intel® Pentium® 4 processor with EIST support
- BIOS file with EIST support
- Operating system with EIST support (Windows® XP SP2/Linux 2.6 kernel or later versions)

A.1.2 Using the EIST

To use the EIST feature:

1. Turn on the computer, then enter the BIOS Setup.
2. Go to the Advanced Menu, highlight CPU Configuration, then press <Enter>.
3. Set the **Intel(R) SpeedStep Technology** item to [Automatic], then press <Enter>.
4. Press <F10> to save your changes and exit the BIOS setup.
5. After the computer restarts, right click on a blank space on the desktop, then select Properties from the pop-up menu.
6. When the Display Properties window appears, click the **Screen Saver** tab.
7. Click the Power button on the Monitor power section to open the Power Options Properties window.

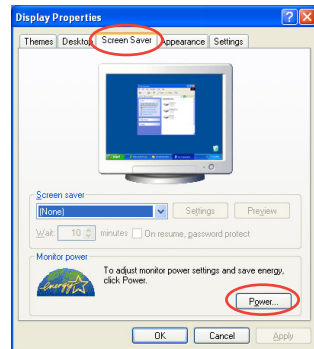

8. On the Power schemes section, click , then select any option except Home/Office Desktop or Always On.
9. Click Apply, then click **OK**.
10. Close the Display Properties window.

After you adjust the power scheme, the CPU internal frequency slightly decreases when the CPU loading is low.

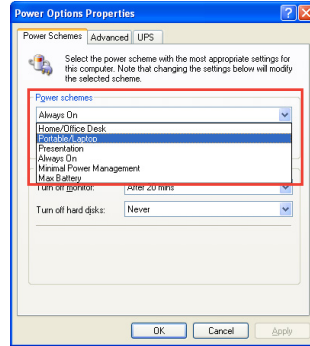

The screen displays and procedures may vary depending on the operating system.

A.2 Intel® Hyper-Threading Technology



- The motherboard supports Intel® Pentium® 4 LGA775 processors with Hyper-Threading Technology.
 - Hyper-Threading Technology is supported under Windows® XP and Linux 2.4.x (kernel) and later versions only. Under Linux, use the Hyper-Threading compiler to compile the code. If you are using any other operating systems, disable the Hyper-Threading Technology item in the BIOS to ensure system stability and performance.
 - Installing Windows® XP Service Pack 1 or later version is recommended.
 - Make sure to enable the Hyper-Threading Technology item in BIOS before installing a supported operating system.
 - For more information on Hyper-Threading Technology, visit www.intel.com/info/hyperthreading.
-

Using the Hyper-Threading Technology

To use the Hyper-Threading Technology:

1. Install an Intel® Pentium® 4 CPU that supports Hyper-Threading Technology.
2. Power up the system and enter the BIOS Setup. Under the Advanced Menu, make sure that the item Hyper-Threading Technology is set to Enabled.
The BIOS item appears only if you installed a CPU that supports Hyper-Threading Technology.
3. Restart the computer.