

**Maximus Formula
(Special Edition)/
Maximus Formula**

ASUS[®]

Motherboard

E3374

First Edition V1
September 2007

Copyright © 2007 ASUSTeK COMPUTER INC. All Rights Reserved.

No part of this manual, including the products and software described in it, may be reproduced, transmitted, transcribed, stored in a retrieval system, or translated into any language in any form or by any means, except documentation kept by the purchaser for backup purposes, without the express written permission of ASUSTeK COMPUTER INC. ("ASUS").

Product warranty or service will not be extended if: (1) the product is repaired, modified or altered, unless such repair, modification or alteration is authorized in writing by ASUS; or (2) the serial number of the product is defaced or missing.

ASUS PROVIDES THIS MANUAL "AS IS" WITHOUT WARRANTY OF ANY KIND, EITHER EXPRESS OR IMPLIED, INCLUDING BUT NOT LIMITED TO THE IMPLIED WARRANTIES OR CONDITIONS OF MERCHANTABILITY OR FITNESS FOR A PARTICULAR PURPOSE. IN NO EVENT SHALL ASUS, ITS DIRECTORS, OFFICERS, EMPLOYEES OR AGENTS BE LIABLE FOR ANY INDIRECT, SPECIAL, INCIDENTAL, OR CONSEQUENTIAL DAMAGES (INCLUDING DAMAGES FOR LOSS OF PROFITS, LOSS OF BUSINESS, LOSS OF USE OR DATA, INTERRUPTION OF BUSINESS AND THE LIKE), EVEN IF ASUS HAS BEEN ADVISED OF THE POSSIBILITY OF SUCH DAMAGES ARISING FROM ANY DEFECT OR ERROR IN THIS MANUAL OR PRODUCT.

SPECIFICATIONS AND INFORMATION CONTAINED IN THIS MANUAL ARE FURNISHED FOR INFORMATIONAL USE ONLY, AND ARE SUBJECT TO CHANGE AT ANY TIME WITHOUT NOTICE, AND SHOULD NOT BE CONSTRUED AS A COMMITMENT BY ASUS. ASUS ASSUMES NO RESPONSIBILITY OR LIABILITY FOR ANY ERRORS OR INACCURACIES THAT MAY APPEAR IN THIS MANUAL, INCLUDING THE PRODUCTS AND SOFTWARE DESCRIBED IN IT.

Products and corporate names appearing in this manual may or may not be registered trademarks or copyrights of their respective companies, and are used only for identification or explanation and to the owners' benefit, without intent to infringe.

Contents

Contents	iii
Notices	vii
Safety information	viii
About this guide	ix
Maximus Formula (Special Edition) / Maximus Formula specifications summary	xi

Chapter 1: Product introduction

1.1	Welcome!	1-1
1.2	Package contents	1-1
1.3	Special features	1-2
1.3.1	Product highlights	1-2
1.3.2	ROG Intelligent Performance & Overclocking features... ..	1-4
1.3.3	ROG unique features	1-6
1.3.4	ASUS special features	1-7

Chapter 2: Hardware information

2.1	Before you proceed	2-1
2.2	Motherboard overview	2-4
2.2.1	Placement direction	2-4
2.2.2	Screw holes	2-4
2.2.3	Motherboard layout	2-5
2.2.4	Audio card layout	2-5
2.2.5	Layout contents	2-6
2.3	Central Processing Unit (CPU)	2-8
2.3.1	Installing the CPU	2-9
2.3.2	Installing the CPU heatsink and fan	2-11
2.3.3	Uninstalling the CPU heatsink and fan	2-13
2.3.4	Installing the optional fans	2-15
2.4	System memory	2-16
2.4.1	Overview	2-16
2.4.2	Memory configurations	2-17
2.4.3	Installing a DIMM	2-20
2.4.4	Removing a DIMM	2-20
2.5	Expansion slots	2-21
2.5.1	Installing an expansion card	2-21

Contents

- 2.5.2 Configuring an expansion card 2-21
- 2.5.3 Interrupt assignments 2-22
- 2.5.4 PCI slots..... 2-23
- 2.5.5 PCI Express x1 slots..... 2-23
- 2.5.6 PCI Express x16 slots..... 2-23
- 2.6 Switch..... 2-24**
- 2.7 Audio card, I/O shield, and LCD Poster installation 2-25**
 - 2.7.1 Audio card Installation..... 2-25
 - 2.7.2 I/O shield and LCD Poster Installation 2-26
- 2.8 Connectors 2-27**
 - 2.8.1 Rear panel connectors..... 2-27
 - 2.8.2 Internal connectors 2-29
 - 2.8.3 Onboard switches 2-38
 - 2.8.4 Installing Fusion Block System accessory 2-39

- Chapter 3: Powering up**
 - 3.1 Starting up for the first time..... 3-1**
 - 3.2 Turning off the computer..... 3-2**
 - 3.2.1 Using the OS shut down function..... 3-2
 - 3.2.2 Using the dual function power switch..... 3-2

- Chapter 4: BIOS setup**
 - 4.1 Managing and updating your BIOS 4-1**
 - 4.1.1 ASUS Update utility 4-1
 - 4.1.2 Creating a bootable floppy disk..... 4-4
 - 4.1.3 ASUS EZ Flash 2 utility..... 4-5
 - 4.1.4 AFUDOS utility..... 4-6
 - 4.1.5 ASUS CrashFree BIOS 3 utility 4-8
 - 4.2 BIOS setup program 4-9**
 - 4.2.1 BIOS menu screen..... 4-10
 - 4.2.2 Menu bar..... 4-10
 - 4.2.3 Navigation keys..... 4-10
 - 4.2.4 Menu items 4-11
 - 4.2.5 Sub-menu items..... 4-11
 - 4.2.6 Configuration fields 4-11
 - 4.2.7 Pop-up window 4-11

Contents

4.2.8	Scroll bar	4-11
4.2.9	General help	4-11
4.3	Main menu	4-12
4.3.1	System Time	4-12
4.3.2	System Date	4-12
4.3.3	Legacy Diskette A	4-12
4.3.4	Language	4-12
4.3.5	SATA 1-6.....	4-13
4.3.6	SATA Configuration	4-14
4.3.7	AHCI Configuration	4-15
4.3.8	System Information	4-16
4.4	Extreme Tweaker menu	4-17
4.4.1	Configure System Performance Settings	4-17
4.5	Advanced menu	4-23
4.5.1	CPU Configuration	4-24
4.5.2	Chipset	4-25
4.5.3	OnBoard Devices Configuration	4-26
4.5.4	USB Configuration	4-27
4.5.5	PCI PnP	4-28
4.6	Power menu.....	4-29
4.6.1	Suspend Mode	4-29
4.6.2	Repost Video on S3 Resume.....	4-29
4.6.3	ACPI Version.....	4-29
4.6.4	ACPI APIC Support.....	4-29
4.6.5	APM Configuration.....	4-30
4.6.6	Hardware Monitor	4-31
4.7	Boot menu	4-34
4.7.1	Boot Device Priority	4-34
4.7.2	Boot Settings Configuration	4-35
4.7.3	Security	4-36
4.8	Tools menu	4-38
4.8.1	ASUS EZ Flash 2.....	4-38
4.8.2	ASUS O.C. Profile.....	4-39
4.8.3	AI Net 2	4-40
4.9	Exit menu	4-41

Contents

Chapter 5: Software support

5.1	Installing an operating system	5-1
5.2	Support DVD information	5-1
5.2.1	Running the support DVD	5-1
5.2.2	Drivers menu.....	5-2
5.2.3	Utilities menu	5-3
5.2.4	Make Disk menu	5-5
5.2.5	Manuals menu	5-6
5.2.6	Video menu.....	5-6
5.2.7	ASUS Contact information	5-7
5.2.8	Other information	5-7
5.3	Software information	5-9
5.3.1	ASUS MyLogo 3™	5-9
5.3.2	AI NET 2.....	5-11
5.3.3	AI Audio 2 (SoundMAX® High Definition Audio utility) ...	5-12
5.3.4	ASUS PC Probe II.....	5-21
5.3.5	ASUS AI Suite.....	5-27
5.3.6	ASUS EPU Utility—AI Gear 3	5-29
5.3.7	ASUS AI Nap	5-30
5.3.8	ASUS Q-Fan 2	5-31
5.3.9	ASUS AI Booster.....	5-32
5.4	RAID configurations	5-33
5.4.1	RAID definitions	5-33
5.4.2	Installing Serial ATA hard disks	5-34
5.4.3	Intel® RAID configurations.....	5-34
5.5	Creating a RAID driver disk.....	5-42
5.5.1	Creating a RAID driver disk without entering the OS....	5-42
5.5.2	Creating a RAID/SATA driver disk in Windows®	5-42

Appendix: CPU features

A.1	Intel® EM64T.....	A-1
A.2	Enhanced Intel SpeedStep® Technology (EIST)	A-1
A.2.1	System requirements	A-1
A.2.2	Using the EIST	A-2
A.3	Intel® Hyper-Threading Technology	A-3
	Using the Hyper-Threading Technology	A-3
A.4	Debug Code Table.....	A-4

Notices

Federal Communications Commission Statement

This device complies with Part 15 of the FCC Rules. Operation is subject to the following two conditions:

- This device may not cause harmful interference, and
- This device must accept any interference received including interference that may cause undesired operation.

This equipment has been tested and found to comply with the limits for a Class B digital device, pursuant to Part 15 of the FCC Rules. These limits are designed to provide reasonable protection against harmful interference in a residential installation. This equipment generates, uses and can radiate radio frequency energy and, if not installed and used in accordance with manufacturer's instructions, may cause harmful interference to radio communications. However, there is no guarantee that interference will not occur in a particular installation. If this equipment does cause harmful interference to radio or television reception, which can be determined by turning the equipment off and on, the user is encouraged to try to correct the interference by one or more of the following measures:

- Reorient or relocate the receiving antenna.
- Increase the separation between the equipment and receiver.
- Connect the equipment to an outlet on a circuit different from that to which the receiver is connected.
- Consult the dealer or an experienced radio/TV technician for help.



The use of shielded cables for connection of the monitor to the graphics card is required to assure compliance with FCC regulations. Changes or modifications to this unit not expressly approved by the party responsible for compliance could void the user's authority to operate this equipment.

Canadian Department of Communications Statement

This digital apparatus does not exceed the Class B limits for radio noise emissions from digital apparatus set out in the Radio Interference Regulations of the Canadian Department of Communications.

This class B digital apparatus complies with Canadian ICES-003.

Safety information

Electrical safety

- To prevent electrical shock hazard, disconnect the power cable from the electrical outlet before relocating the system.
- When adding or removing devices to or from the system, ensure that the power cables for the devices are unplugged before the signal cables are connected. If possible, disconnect all power cables from the existing system before you add a device.
- Before connecting or removing signal cables from the motherboard, ensure that all power cables are unplugged.
- Seek professional assistance before using an adapter or extension cord. These devices could interrupt the grounding circuit.
- Make sure that your power supply is set to the correct voltage in your area. If you are not sure about the voltage of the electrical outlet you are using, contact your local power company.
- If the power supply is broken, do not try to fix it by yourself. Contact a qualified service technician or your retailer.

Operation safety

- Before installing the motherboard and adding devices on it, carefully read all the manuals that came with the package.
- Before using the product, make sure all cables are correctly connected and the power cables are not damaged. If you detect any damage, contact your dealer immediately.
- To avoid short circuits, keep paper clips, screws, and staples away from connectors, slots, sockets and circuitry.
- Avoid dust, humidity, and temperature extremes. Do not place the product in any area where it may become wet.
- Place the product on a stable surface.
- If you encounter technical problems with the product, contact a qualified service technician or your retailer.



This symbol of the crossed out wheeled bin indicates that the product (electrical and electronic equipment, and mercury-containing button cell battery) should not be placed in municipal waste. Check local regulations for disposal of electronic products.

About this guide

This user guide contains the information you need when installing and configuring the motherboard.

How this guide is organized

This guide contains the following parts:

- **Chapter 1: Product introduction**
This chapter describes the features of the motherboard and the new technology it supports.
- **Chapter 2: Hardware information**
This chapter lists the hardware setup procedures that you have to perform when installing system components. It includes description of the switches, jumpers, and connectors on the motherboard.
- **Chapter 3: Powering up**
This chapter describes the power up sequence and ways of shutting down the system.
- **Chapter 4: BIOS setup**
This chapter tells how to change system settings through the BIOS Setup menus. Detailed descriptions of the BIOS parameters are also provided.
- **Chapter 5: Software support**
This chapter describes the contents of the support DVD that comes with the motherboard package and the software.
- **Appendix: CPU features**
The Appendix describes the CPU features and technologies that the motherboard supports as well as the debug code table for the LCD Poster.

Where to find more information

Refer to the following sources for additional information and for product and software updates.

1. ASUS websites

The ASUS website provides updated information on ASUS hardware and software products. Refer to the ASUS contact information.

2. Optional documentation

Your product package may include optional documentation, such as warranty flyers, that may have been added by your dealer. These documents are not part of the standard package.

Conventions used in this guide

To make sure that you perform certain tasks properly, take note of the following symbols used throughout this manual.



DANGER/WARNING: Information to prevent injury to yourself when trying to complete a task.



CAUTION: Information to prevent damage to the components when trying to complete a task.



IMPORTANT: Instructions that you **MUST** follow to complete a task.



NOTE: Tips and additional information to help you complete a task.

Typography

Bold text

Indicates a menu or an item to select.

Italics

Used to emphasize a word or a phrase.

<Key>

Keys enclosed in the less-than and greater-than sign means that you must press the enclosed key.

Example: <Enter> means that you must press the Enter or Return key.

<Key1+Key2+Key3>

If you must press two or more keys simultaneously, the key names are linked with a plus sign (+).

Example: <Ctrl+Alt+D>

Command

Means that you must type the command exactly as shown, then supply the required item or value enclosed in brackets.

Example: At the DOS prompt, type the command line:

```
afudos /i [filename]
```

```
afudos /iFormula.ROM
```

Maximus Formula (Special Edition) / Maximus Formula specifications summary

CPU	LGA775 socket for Intel® Core™2 Quad / Core™2 Extreme / Core™2 Duo / Pentium® Extreme / Pentium® D / Pentium® 4 processors Supports Intel® next-generation 45nm multi-core CPUs Compatible with Intel® 06/05B/05A processors * Refer to www.asus.com for Intel CPU support list
Chipset	Intel® X38 / ICH9R with Intel® Fast Memory Access Technology
System Bus	1333/1066/800 MHz
Memory	Dual-channel memory architecture <ul style="list-style-type: none"> - 4 x 240-pin DIMM sockets support unbuffered ECC / non-ECC DDR2 1066*/800/667MHz memory modules - Supports up to 8 GB system memory <p>* The chipset officially supports the memory frequency up to DDR2 800MHz. Tuned by the ASUS Super Memspeed Technology, this motherboard natively supports up to DDR2 1066MHz. Refer to www.asus.com or this user manual for the Memory QVL (Qualified Vendors Lists).</p>
Expansion Slots	2 x PCIe x16 slots (@ full x16, x16 speed) 3 x PCIe x1 (PCIEX1_1 (black) is compatible with the audio slot.) 2 x PCI 2.2 slots
CrossFire™ Technology	Supports ATI CrossFire™ graphics cards
Storage	Southbridge <ul style="list-style-type: none"> - 6 x SATA 3.0 Gb/s ports - Intel® Matrix Storage Technology supports RAID 0, 1, 5, and 10 <p>JMicron® JMB368 PATA controller - 1 x UltraDMA 133/100/66 for up to 2 PATA devices</p>
LAN	Dual Gigabit LAN controllers, both featuring AI NET 2 Supports Teaming Technology
High Definition Audio	SupremeFX II Audio Card <ul style="list-style-type: none"> - ADI 1988B 8-channel High Definition Audio CODEC - Noise Filter <p>Coaxial / Optical S/PDIF Out ports at back I/O</p>
IEEE 1394	2 x IEEE 1394a ports (one at midboard; one at back panel)
USB	12 x USB 2.0 ports (6 ports at midboard, 6 ports at back panel)

(continued on the next page)

Maximus Formula (Special Edition) / Maximus Formula specifications summary

ROG Exclusive Overclocking features	<p>Fusion Block System <i>(for Special Edition only)</i> Extreme Tweaker 2-Phase DDR2 Loadline Calibration Intelligent overclocking tools:</p> <ul style="list-style-type: none"> - CPU Level Up - AI Gear 3 - AI Overclocking (intelligent CPU frequency tuner) - AI Booster Utility - O.C. Profile <p>Overclocking protection:</p> <ul style="list-style-type: none"> - COP EX (Component Overheat Protection -EX) - Voltminder LED - ASUS C.P.R. (CPU Parameter Recall)
ROG Special Features	<p>LCD Poster Onboard Switches: Power / Reset / Clr CMOS (at rear panel) ASUS Q-Connector ASUS Q-Fan 2 ASUS EZ Flash 2 ASUS CrashFree BIOS 3 ASUS MyLogo 3™</p>
Back Panel I/O Ports	<p>1 x PS/2 Keyboard (purple) 1 x S/PDIF Out (Coaxial + Optical) 1 x IEEE1394a port 2 x LAN (RJ45) ports 6 x USB 2.0/1.1 ports 1 x Clr CMOS switch</p>
Internal I/O Connectors	<p>3 x USB connectors support additional 6 USB ports 1 x Floppy disk drive connector 1 x IDE connector for two devices 6 x SATA connectors 8 x Fan connectors (1 x CPU / 1 x Power / 3 x Chassis / 3 x Optional) 3 x Thermal sensor connectors 1 x IEEE1394a connector 1 x S/PDIF Out connector 1 x Chassis Intrusion connector 24-pin ATX Power connector 8-pin ATX 12V Power connector 1 x En/Dis-able Clr CMOS 1 x LCD Poster connector 1 x System panel connector 1 x Power-on switch 1 x Reset switch</p>

(continued on the next page)

Maximus Formula (Special Edition) / Maximus Formula specifications summary

BIOS Features	16 Mb Flash ROM, AMI BIOS, PnP, DMI2.0, WfM2.0, SM BIOS 2.4, ACPI 2.0a Multi-Language BIOS
Manageability	WOL by PME, WOR by PME, Chassis Intrusion, PXE
Accessories	Fusion Block System Accessory (<i>for Special Edition only</i>) LCD Poster ASUS Optional Fan SupremeFX II Audio Card 3 in 1 ASUS Q-connector kit UltraDMA 133/100/66 cable Floppy disk drive cable Serial ATA cables Serial ATA power cables 2-port USB2.0 + IEEE 1394a module I/O Shield Cable ties User's manual
Software	The hottest 3D game: S.T.A.L.K.E.R. Support DVD: Drivers ASUS PC Probe II ASUS Update ASUS AI Suite Futuremark® 3DMark® 06 Advanced Edition Kaspersky® Anti-virus software
Form Factor	ATX Form Factor, 12"x 9.6" (30.5 cm x 24.4 cm)

*Specifications are subject to change without notice.

This chapter describes the motherboard features and the new technologies it supports.

1 Product introduction

Chapter summary



1.1	Welcome!	1-1
1.2	Package contents.....	1-1
1.3	Special features.....	1-2

1.1 Welcome!

Thank you for buying an ASUS® Maximus Formula (Special Edition) / Maximus Formula motherboard!

The motherboard delivers a host of new features and latest technologies, making it another standout in the long line of ASUS quality motherboards!

Before you start installing the motherboard, and hardware devices on it, check the items in your package with the list below.

1.2 Package contents

Check your motherboard package for the following items.

Motherboard	ROG Maximus Formula (Special Edition) / Maximus Formula
I/O module	USB 2.0 + IEEE 1394a module
Cables	Ultra DMA 133/100/66 cable Floppy disk drive cable Serial ATA cables Serial ATA power cables
Accessories	I/O shield ASUS Optional Fan Fusion Block System Accessory (for Special Edition only) LCD Poster SupremeFX II Audio Card 3-in-1 ASUS Q-Connector Kit Cable ties
Application DVD/CD	ROG motherboard support DVD The hottest game: S.T.A.L.K.E.R.
Documentation	User guide



If any of the above items is damaged or missing, contact your retailer.

1.3 Special features

1.3.1 Product highlights

Republic of Gamers



The Republic of Gamers consists only the best of the best. We offer the best hardware engineering, the fastest performance, the most innovating ideas, and we welcome the best gamers to join in. In the Republic of Gamers, mercy rules are only for the weak, and bragging rights means everything. We believe in making statements and we excel in competitions. If your character matches our trait, then join the elite club, make your presence felt, in the Republic of Gamers.

Intel® Quad-core Processor ready



This motherboard supports the latest Intel® Quad-core processors in the LGA775 package and Intel's next-generation 45nm multi-core processors. It is excellent for multi-tasking, multi-media and enthusiastic gamers with 1333/1066/800 MHz FSB. Intel® Quad-core processor is one of the most powerful CPU in the world. See page 2-8 for details.

Intel® Core™2 Duo/ Intel® Core™2 Extreme CPU support



This motherboard supports the latest Intel® Core™2 processor in the LGA775 package and Intel's next-generation 45nm multi-core processors. With the new Intel® Core™ microarchitecture technology and 1333/1066/800 MHz FSB, the Intel® Core™2 is one of the most powerful and energy efficient CPUs in the world. See page 2-8 for details.

Intel® X38 Chipset



The Intel® X38 Express Chipset is the latest chipset designed to support 8GB of dual-channel DDR2 1066/800/677 architecture, 1333/1066/800 FSB (Front Side Bus), dual PCI Express 2.0 x16 graphics, and multi-core CPUs. With the specially included Intel® Fast Memory Access technology, available memory bandwidth usage is optimized and memory access latency is reduced—allowing faster memory speed.

ATI CrossFire™ Technology



ATI's CrossFire™ boosts image quality along with rendering speed, eliminating the need to scale down screen resolution to get high quality images. CrossFire™ allows higher antialiasing, anisotropic filtering, shading, and texture settings. Adjust your display configurations, experiment with the advanced 3D settings, and check the effects with a real-time 3D-rendered previews within ATI Catalyst™ Control Center.

Native DDR2 1066 memory support



To attain top performance, ASUS engineers have successfully unleashed the true potential of DDR2 memory. While in DDR2 1066 mode, ASUS's exclusive technology offers a choice of FSB 1333, providing great performance for 3D graphics and other memory demanding applications. See page 2-16 for details.

Dual-channel DDR2 800 memory support



The motherboard supports DDR2 memory that features data transfer rates of 800/667 MHz to meet the higher bandwidth requirements of the latest 3D graphics, multimedia, and Internet applications. The dual-channel DDR2 architecture doubles the bandwidth of your system memory to boost system performance, eliminating bottlenecks with peak bandwidths of up to 12.8 GB/s. Furthermore, this motherboard does not restrict the memory size across two channels. Users may install different memory size DIMMs into the two channels and enjoy dual-channel and single-channel functions at the same time. This new feature optimizes the use of available memory size. See page 2-16 for details.

ASUS Super Memspeed Technology

To attain top performance, ASUS has managed to break through current FSB and DRAM ratio proportions by utilizing Super Memspeed Technology—the latest technology that provides even more precise overclocking options to unleash the true potential of DDR2 memory. The DDR2 Mode maximizes system performance by eliminating the bottleneck when overclocking both the CPU and memory—providing great performance for 3D graphics and other memory demanding applications. See page 2-16 for details.

Serial ATA 3.0 Gb/s technology



This motherboard supports the next-generation hard drives based on the Serial ATA (SATA) 3Gb/s storage specification, delivering enhanced scalability and doubling the bus bandwidth for high-speed data retrieval and saves. See page 2-30 for details.

Dual Gigabit LAN



The integrated dual Gigabit LAN design allows a PC to serve as a network gateway for managing traffic between two separate networks. This capability ensures rapid transfer of data from WAN to LAN without any added arbitration or latency. See page 2-27 for details.

IEEE 1394a support



The IEEE 1394a interface provides high speed digital interface for audio/video appliances such as digital television, digital video camcorders, storage peripherals & other PC portable devices. See pages 2-28 and 2-32 for details.

High Definition Audio



Enjoy high-end sound quality on your PC! The onboard 8-channel HD audio (High Definition Audio, previously codenamed Azalia) CODEC enables high-quality 192KHz/24-bit audio output, jack-sensing feature, retasking functions, and multi-streaming technology that simultaneously sends different audio streams to different destinations. You can now talk to your partners on the headphones while playing multi-channel network games. See pages 2-28 for details.

Green ASUS



This motherboard and its packaging comply with the European Union's Restriction on the use of Hazardous Substances (RoHS). This is in line with the ASUS vision of creating environment-friendly and recyclable products/packaging to safeguard consumers' health while minimizing the impact on the environment.

1.3.2 ROG Intelligent Performance & Overclocking features

Fusion Block System *(for Special Edition only)*



The Fusion Block System is a more efficient thermal solution compared to competing followers with complicated looks. It is a hybrid thermal design that combines the ROG's renowned heatpipe design with the additional ability to connect to a water cooling system. By taking the entire integrated solution into design considerations, the user can enjoy exceptional thermal improvement to the northbridge and southbridge with a single connection. The Fusion Block System is the most versatile, efficient, and advanced thermal system there is on a motherboard.

CPU Level Up



Ever wish that you could have a more expansive CPU? Upgrade your CPU at no additional cost with ROG's CPU Level Up! Simply choose a processor you want to OC to, and the motherboard will do the rest for you. See the new CPU speed and enjoy the performance instantly! Overclocking is never as easy as this. See pages 4-17 and 4-18 for details.

ASUS EPU



The ASUS EPU utilizes innovative technology to digitally monitor and tune the CPU power supply with improved VR responses in heavy or light loadings. It automatically provides power for higher performance or improve efficiency by 7% when the PC is running low intensity applications. Working together with AI Gear 3, this can help you attain the best possible power efficiency and energy savings up to 20% to help save the environment. See page 5-29 for details.

2-Phase DDR2



With the embedded 2-Phase DDR2, this motherboard allows users to reach higher memory frequencies and enjoy better performance. Compared with only one phase solutions, this motherboard ensures longer power component lifespans and higher overclockability due to cooler temperatures and better efficiency.

Extreme Tweaker



Extreme Tweaker is the one stop shop to fine-tune your system to optimal performance. No matter if you are looking for frequency adjustment, over-voltage options, or memory timing settings, they are all here! See page 4-17 for details.

Voltiminder LED



In the pursuit of extreme performance, overvoltage adjustment is critical but risky. Acting as the “red zone” of a tachometer, the Voltiminder LED displays the voltage status for CPU, NB, SB, and Memory in a intuitive color-coded fashion. The Voltiminder LED allows quick voltage monitoring for overclockers. See pages 2-1 to 2-3 for details.

Component Overheat Protection -EX (COP EX)



The COP EX allows overclockers to increase chipset voltages without the worries of overheating. It can also be used to monitor and save an overheating GPU. The COP EX allows more freedom and less constraint for maximum performance achievement.

AI Booster

The ASUS AI Booster allows you to overclock the CPU speed in Windows environment without the hassle of booting the BIOS. See page 5-32 for details.

ASUS O.C. Profile



The motherboard features the ASUS O.C. Profile that allows users to conveniently store or load multiple BIOS settings. The BIOS settings can be stored in the CMOS or a separate file, giving users freedom to share and distribute their favorite settings. See page 4-39 for details.

C.P.R. (CPU Parameter Recall)

When the system hangs due to overclocking failure, there is no need to open the system chassis to clear CMOS data. Simply reboot the system, and the BIOS automatically restores the CPU default settings for each parameter.



Due to the chipset behavior, AC power off is required before using C.P.R. function.

1.3.3 ROG unique features

Supreme FX II features

Supreme FX II delivers an excellent high definition audio experience to the gamers of ROG. The SupremeFX II features unique audio innovations for gamers to spot enemies in 3D environment during game play. SupremeFX II also provides a special tool to emphasize human voices in games to help make dialogues clearer.

Noise Filter

This feature detects repetitive and stationary noises (non-voice signals) like computer fans, air conditioners, and other background noises then eliminates it in the incoming audio stream while recording.

External LCD Poster

The new LCD Poster now posts critical POST information in an ever friendly and flexible external display. When system malfunction occurs, the LCD Poster automatically detects device failure and translates the errors on the LCD during POST. Unlike other competing 2 digit displays, users do not need to read “gibberish” to find out what is wrong. See page 2-26 for details.

Onboard Switches

With an easy press during overclocking, this exclusive onboard switch allows gamers to effortlessly fine-tune the performance without having to short the pins or moving jumpers. See page 2-38 for details.

ASUS Quiet Thermal Solution

ASUS Quiet Thermal solution makes system more stable and enhances the overclocking capability.

Fanless Design—Heat-pipe



The ASUS fanless design allows multi-directional heat flow from major thermal sources in the motherboard to lower overall system temperature, resulting in quieter operation and longer system life. ASUS has devoted special efforts to address the thermal issues across the motherboard, and most notably in the following areas: CPU, power, VGA, Northbridge and Southbridge. The heat pipe, heatsink, and strategic board layout were tailor made to dissipate heat in the most efficient manner.

Fanless Design—Stack Cool 2



ASUS Stack Cool 2 is a fan-less and zero-noise cooling solution that lowers the temperature of critical heat generating components. The motherboard uses a special design on the printed circuit board (PCB) to dissipate heat these critical components generate.

1.3.4 ASUS special features

AI Gear 3



With a manual or automatic mode, AI Gear 3 allows users to choose from four profiles to adjust CPU frequency and vCore voltage—“Turbo Mode,” “High Performance Mode,” “Medium Power Saving Mode,” and “Max Power Saving Mode.” As a digital solution, AI Gear 3 is very precise and can automatically detect current CPU loading, dynamically overclocking the CPU speed in real time and lowering the voltage for power saving during light loading. With this power saving mode, users can make real-time changes in the operating system and can save up to 62% CPU power in light loading. See page 5-29 for details.

AI Nap



With AI Nap, the system can continue running at minimum power and noise when you are temporarily away. To wake the system and return to the OS environment, simply click the mouse or press a key. See page 5-30 for details.

ASUS Q-Fan 2



ASUS Q-Fan 2 technology intelligently adjusts both CPU fan and chassis fan speeds according to system loading to ensure quiet, cool and efficient operation. See pages 4-31, 4-32, and 5-31 for details.

Optional Fan *(for water-cooling/passive-cooling only)*



The optional fan is specifically designed to provide sufficient airflow over the CPU power modules and chipset area when water-cooling or passive-cooling is utilized, ensuring effective heat dissipation for the entire system. See pages 2-15 and 2-33 for details.

ASUS MyLogo 3



ASUS MyLogo 3 is a new feature present in the motherboard that allows you to personalize and add style to your system with customizable and animated boot logos. See page 5-9 for details.

ASUS Multi-language BIOS



The multi-language BIOS allows you to select the language of your choice from the available options. The localized BIOS menus allow easier and faster configuration. See page 4-12 for details.

ASUS EZ DIY

ASUS EZ DIY feature collection provides you easy ways to install computer components, update the BIOS or back up your favorite settings.

ASUS Q-Connector



The ASUS Q-Connector allows you to connect or disconnect chassis front panel cables in one easy step with one complete module. This unique adapter eliminates the trouble of plugging in one cable at a time, making connection quick and accurate. See pages 2-37 for details.

ASUS EZ Flash 2



EZ Flash 2 is a user-friendly BIOS update utility. Simply launch this tool and update BIOS using a USB flash disk without entering the OS. You can update your BIOS in a few clicks without preparing an additional floppy diskette or using an OS-based flash utility. See pages 4-5 and 4-38 for details.

ASUS CrashFree BIOS 3



The ASUS CrashFree BIOS 3 allows users to restore corrupted BIOS data from a USB flash disk containing the BIOS file. See page 4-8 for details.

This chapter lists the hardware setup procedures that you have to perform when installing system components. It includes description of the jumpers and connectors on the motherboard.

Hardware information

A large, light gray, stylized number '2' is positioned behind the word 'Hardware' in the title.

2.1	Before you proceed	2-1
2.2	Motherboard overview.....	2-4
2.3	Central Processing Unit (CPU)	2-8
2.4	System memory	2-16
2.5	Expansion slots.....	2-21
2.6	Switch.....	2-22
2.7	Audio card, I/O shield, and LCD Poster Installation	2-25
2.8	Connectors	2-27

2.1 Before you proceed

Take note of the following precautions before you install motherboard components or change any motherboard settings.



- Unplug the power cord from the wall socket before touching any component.
- Use a grounded wrist strap or touch a safely grounded object or a metal object, such as the power supply case, before handling components to avoid damaging them due to static electricity.
- Hold components by the edges to avoid touching the ICs on them.
- Whenever you uninstall any component, place it on a grounded antistatic pad or in the bag that came with the component.
- Before you install or remove any component, ensure that the ATX power supply is switched off or the power cord is detached from the power supply. Failure to do so may cause severe damage to the motherboard, peripherals, and/or components.

Onboard LEDs

The motherboard comes with LEDs that indicate the voltage conditions of CPU, memory, northbridge, and southbridge. You may adjust the voltages in BIOS. There are also an LED for hard disk drive activity and an onboard switch for power status. For more information about voltage adjustment, refer to 4.4 Extreme Tweaker menu.

1. CPU LED

The CPU LED has two voltage displays: CPU Voltage and CPU PLL Voltage; you can select the voltage to display in BIOS. Refer to the illustration below for the location of the CPU LED and the table below for LED definition.

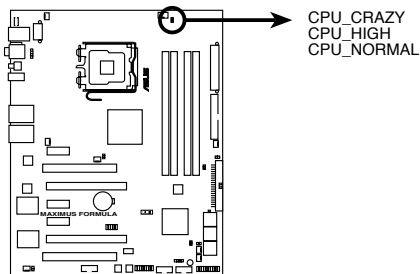

**MAXIMUS FORMULA(Special Edition)/
MAXIMUS FORMULA CPU LED**

	Normal (green)	High (yellow)	Crazy (red)
CPU Voltage	1.10000~1.50000	1.50625~1.69375	1.70000~
CPU PLL Voltage	1.50000~1.60000	1.62000~1.80000	1.82000~

2. Memory LED

Refer to the illustration below for the location of the memory LED and the table below for LED definition.

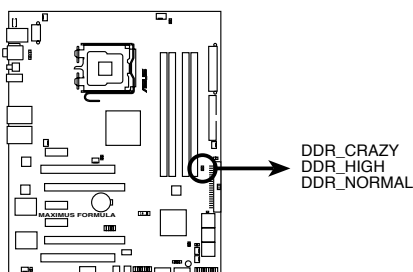

**MAXIMUS FORMULA(Special Edition)/
MAXIMUS FORMULA DDR LED**

	Normal (green)	High (yellow)	Crazy (red)
DRAM Voltage	1.80~2.20	2.22~2.60	2.62~

3. Northbridge/Southbridge LEDs

The northbridge and southbridge LEDs each have two different voltage displays. The northbridge LED displays either the North Bridge Voltage or the FSB Termination Voltage. The southbridge LED shows either the South Bridge Voltage or the SB 1.5V Voltage. You can select the voltage to display in BIOS. Refer to the illustration below for the location of the northbridge/ southbridge LEDs and the table below for LED definition.

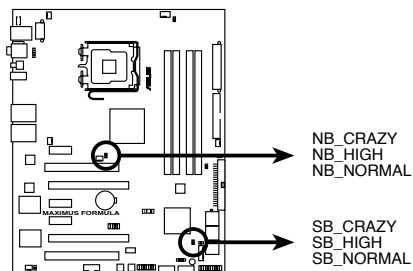

**MAXIMUS FORMULA(Special Edition)/
MAXIMUS FORMULA North/South Bridge LED**

	Normal (green)	High (yellow)	Crazy (red)
North Bridge Voltage	1.25~1.49	1.51~1.73	1.73~
FSB Termination Voltage	1.20~1.40	1.42~1.60	1.62~
South Bridge Voltage	1.050~1.125	1.150~1.175	1.200~
SB 1.5V Voltage	1.50~1.60	1.65~1.85	1.90~

4. Hard Disk LED

The hard disk LED is designed to indicate the hard disk activity. It blinks when data is being written into or read from the hard disk drive. The LED does not light up when there is no hard disk drive connected to the motherboard or when the hard disk drive does not function.

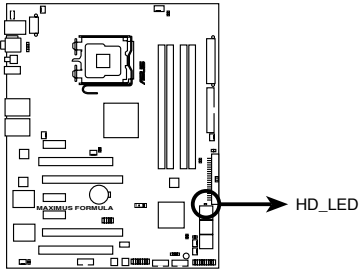

**MAXIMUS FORMULA(Special Edition)/
MAXIMUS FORMULA Hard Disk LED**

5. Power LED

The motherboard comes with a power-on switch that lights up to indicate that the system is ON, in sleep mode, or in soft-off mode. This is a reminder that you should shut down the system and unplug the power cable before removing or plugging in any motherboard component. The illustration below shows the location of the onboard power-on switch.

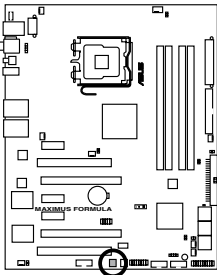

**MAXIMUS FORMULA(Special Edition)/
MAXIMUS FORMULA Power on switch**

2.2 Motherboard overview

Before you install the motherboard, study the configuration of your chassis to ensure that the motherboard fits into it.



Make sure to unplug the power cord before installing or removing the motherboard. Failure to do so can cause you physical injury and damage motherboard components.

2.2.1 Placement direction

When installing the motherboard, make sure that you place it into the chassis in the correct orientation. The edge with external ports goes to the rear part of the chassis as indicated in the image below.

2.2.2 Screw holes

Place nine (9) screws into the holes indicated by circles to secure the motherboard to the chassis.



DO NOT overtighten the screws! Doing so can damage the motherboard.

Place this side towards the rear of the chassis

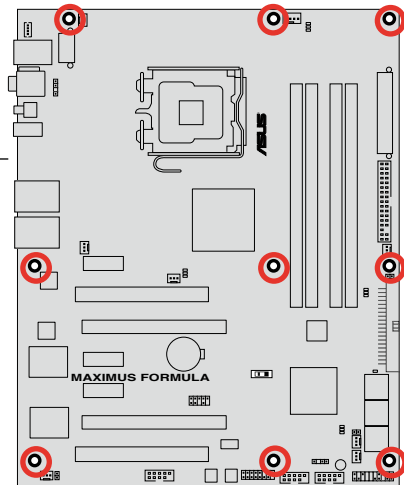

2.2.3 Motherboard layout

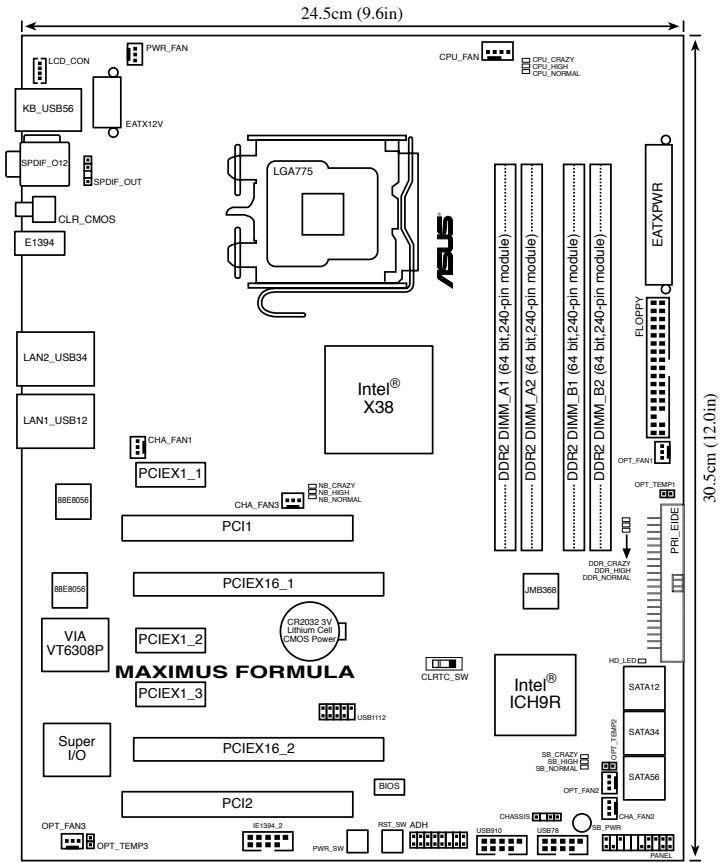

Refer to **2.8 Connectors** for more information about rear panel connectors and internal connectors.

2.2.4 Audio card layout

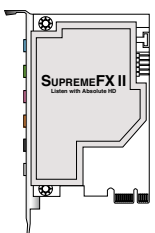

2.2.5 Layout contents

Slots		Page
1.	DDR2 DIMM slots	2-16
2.	PCI slots	2-23
3.	PCI Express x 1 slots	2-23
4.	PCI Express x 16 slots	2-23

Switch		Page
1.	Clear RTC RAM (3-pin CLRRTC_SW)	2-24

Rear panel connectors		Page
1.	PS/2 keyboard port (purple)	2-27
2.	Coaxial S/PDIF Out port	2-27
3.	LAN 2 (RJ-45) port	2-27
4.	LAN 1 (RJ-45) port	2-27
5.*	Line In port (light blue)	2-28
6.*	Line Out port (lime)	2-28
7.*	Microphone port (pink)	2-28
8.*	Center/Subwoofer port (orange)	2-28
9.*	Rear Speaker Out port (black)	2-28
10.*	Side Speaker Out port (gray)	2-28
11.	USB 2.0 ports 1, 2, 3 and 4	2-28
12.	IEEE 1394a port	2-28
13.	Clear CMOS switch	2-28
14.	Optical S/PDIF Out port	2-28
15.	USB 2.0 ports 5 and 6	2-28



*These audio ports are on the Supreme FX II audio card.

Internal connectors		Page
1.	Floppy disk drive connector (34-1 pin FLOPPY)	2- 29
2.	IDE connector (40-1 pin PRI_EIDE)	2- 29
3.	ICH9R Serial ATA connectors (7-pin SATA1~6)	2- 30
4.	USB connectors (10-1 pin USB78, USB910, USB1112)	2- 31
5.	IEEE 1394a port connector (10-1 pin IE1394_2)	2- 32
6.	Thermal sensor cable connectors (2-pin OPT_TEMP1/2/3)	2- 32
7.	CPU, chassis, and optional fan connectors (4-pin CPU_FAN, 3-pin CHA_FAN1~3, 3-pin PWR_FAN, 3-pin OPT_FAN1~3)	2- 33
8.	Chassis intrusion connector (4-1 pin CHASSIS)	2- 34
9.	ATX power connectors (24-pin EATXPWR, 8-pin EATX12V)	2- 34
10.	Digital audio connector (4-1 pin SPDIF_OUT, for ASUS HDMI VGA card)	2- 35
11.	System panel connector (20-8 pin PANEL)	2-36

Onboard switches		Page
1.	Power-on switch	2-38
2.	Reset switch	2-38

2.3 Central Processing Unit (CPU)

The motherboard comes with a surface mount LGA775 socket designed for the Intel® Core™2 Quad / Core™2 Extreme / Core™2 Duo / Pentium® D / Pentium® 4 / Pentium® Extreme processors.



-
- Make sure that all power cables are unplugged before installing the CPU.
 - If installing a dual-core CPU, connect the chassis fan cable to the CHA_FAN1 connector to ensure system stability.
-



-
- Upon purchase of the motherboard, make sure that the PnP cap is on the socket and the socket contacts are not bent. Contact your retailer immediately if the PnP cap is missing, or if you see any damage to the PnP cap/socket contacts/motherboard components. ASUS will shoulder the cost of repair only if the damage is shipment/transit-related.
 - Keep the cap after installing the motherboard. ASUS will process Return Merchandise Authorization (RMA) requests only if the motherboard comes with the cap on the LGA775 socket.
 - The product warranty does not cover damage to the socket contacts resulting from incorrect CPU installation/removal, or misplacement/loss/incorrect removal of the PnP cap.
-

2.3.1 Installing the CPU

To install a CPU:

1. Locate the CPU socket on the motherboard.

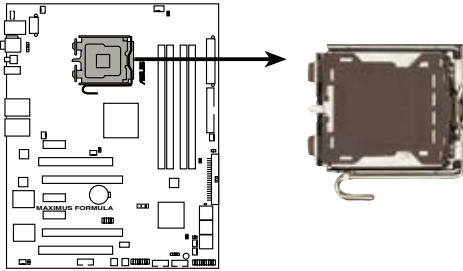

**MAXIMUS FORMULA(Special Edition)/
MAXIMUS FORMULA CPU Socket 775**



Before installing the CPU, make sure that the cam box is facing towards you and the load lever is on your left.

2. Press the load lever with your thumb (A), then move it to the left (B) until it is released from the retention tab.

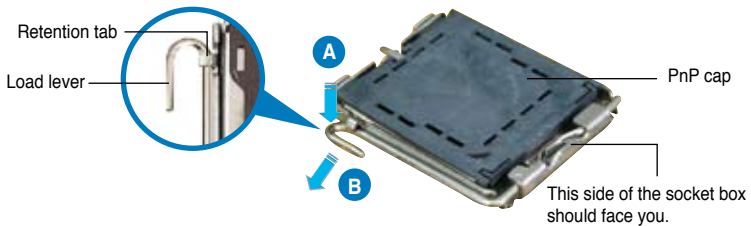

To prevent damage to the socket pins, do not remove the PnP cap unless you are installing a CPU.

3. Lift the load lever in the direction of the arrow to a 135° angle.

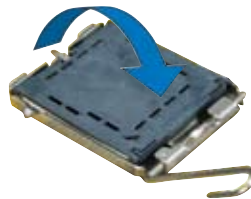

- Lift the load plate with your thumb and forefinger to a 100° angle (A), then push the PnP cap from the load plate window to remove (B).

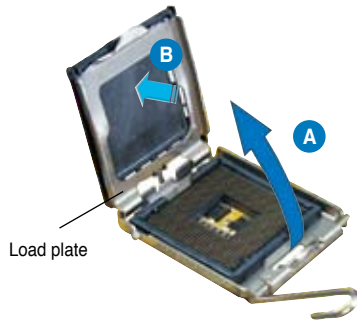

- Position the CPU over the socket, making sure that the gold triangle is on the bottom-left corner of the socket then fit the socket alignment key into the CPU notch.

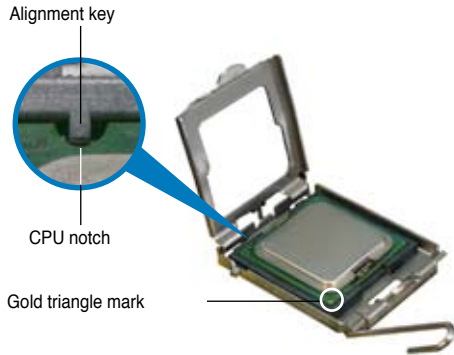

The CPU fits in only one correct orientation. DO NOT force the CPU into the socket to prevent bending the connectors on the socket and damaging the CPU!

- Close the load plate (A), then push the load lever (B) until it snaps into the retention tab.
- If installing a dual-core CPU, connect the chassis fan cable to the CHA_FAN1 connector to ensure system stability.



The motherboard supports Intel® LGA775 processors with the Intel® Enhanced Memory 64 Technology (EM64T), Enhanced Intel SpeedStep® Technology (EIST), and Hyper-Threading Technology. Refer to the Appendix for more information on these CPU features.

2.3.2 Installing the CPU heatsink and fan

The Intel® LGA775 processor requires a specially designed heatsink and fan assembly to ensure optimum thermal condition and performance.



- When you buy a boxed Intel® processor, the package includes the CPU fan and heatsink assembly. If you buy a CPU separately, make sure that you use only Intel®-certified multi-directional heatsink and fan.
- Your Intel® LGA775 heatsink and fan assembly comes in a push-pin design and requires no tool to install.
- If you purchased a separate CPU heatsink and fan assembly, make sure that you have properly applied Thermal Interface Material to the CPU heatsink or CPU before you install the heatsink and fan assembly.



Make sure that you have installed the motherboard to the chassis before you install the CPU fan and heatsink assembly.

To install the CPU heatsink and fan:

1. Place the heatsink on top of the installed CPU, making sure that the four fasteners match the holes on the motherboard.



Orient the heatsink and fan assembly such that the CPU fan cable is closest to the CPU fan connector.

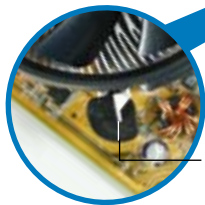

Narrow end of the groove



Motherboard hole
Fastener



Make sure to orient each fastener with the narrow end of the groove pointing outward. (The photo shows the groove shaded for emphasis.)

2. Push down two fasteners at a time in a diagonal sequence to secure the heatsink and fan assembly in place.

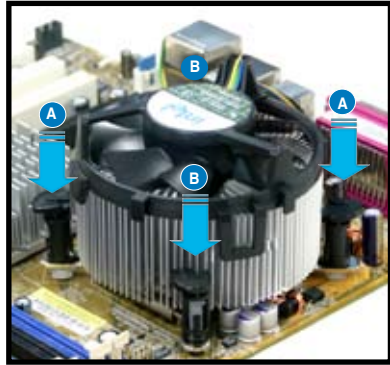
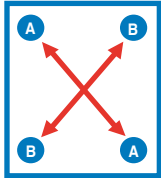

3. Connect the CPU fan cable to the connector on the motherboard labeled CPU_FAN.

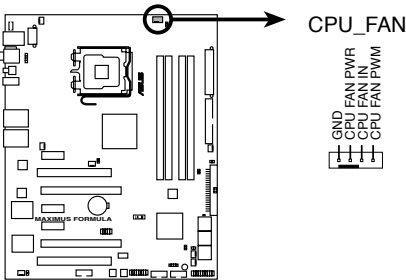

**MAXIMUS FORMULA(Special Edition)/
MAXIMUS FORMULA CPU fan connector**



DO NOT forget to connect the CPU fan connector! Hardware monitoring errors can occur if you fail to plug this connector.

2.3.3 Uninstalling the CPU heatsink and fan

To uninstall the CPU heatsink and fan:

1. Disconnect the CPU fan cable from the connector on the motherboard.
2. Rotate each fastener counterclockwise.

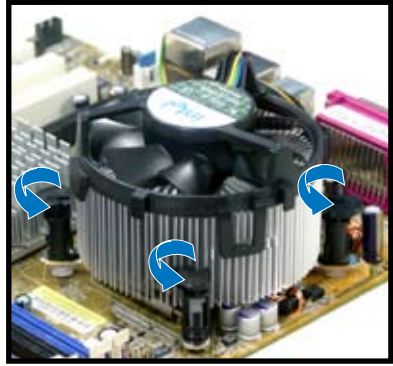

3. Pull up two fasteners at a time in a diagonal sequence to disengage the heatsink and fan assembly from the motherboard.

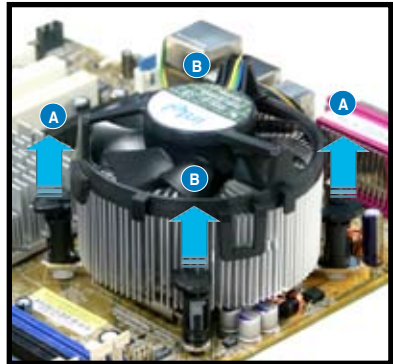
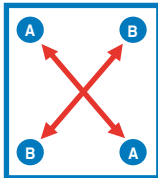

4. Carefully remove the heatsink and fan assembly from the motherboard.



- 5. Rotate each fastener clockwise to ensure correct orientation when reinstalling.

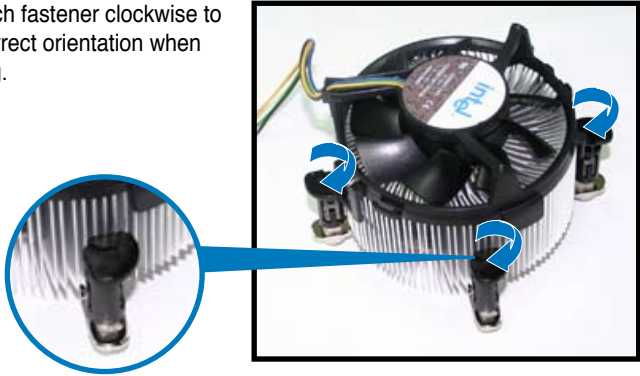

Narrow end of the groove



The narrow end of the groove should point outward after resetting. (The photo shows the groove shaded for emphasis.)



Refer to the documentation in the boxed or stand-alone CPU fan package for detailed information on CPU fan installation.

2.3.4 Installing the optional fans



Install the optional fan only if you are using a passive cooler or a water cooler. Installing the optional fan with an active CPU cooler will interfere with the airflow and destabilize the system.

Optional fan on one side fins

1. Position the fan above the pipe and heatsink assembly.
2. Fit the fan to the grooved edge of the heatsink.

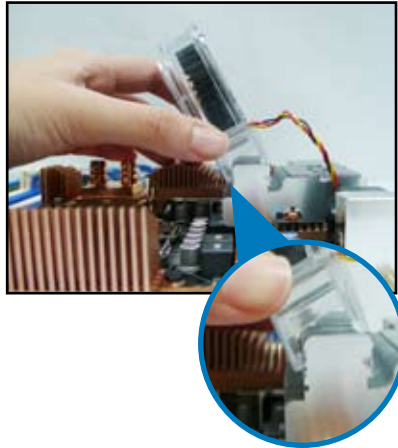
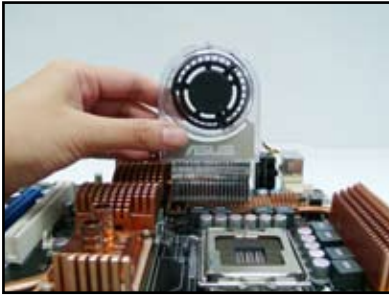

3. Carefully push down the fan until it snugly fits the heatsink, then connect the fan cable.
4. The photo shows the fan installed on the motherboard.

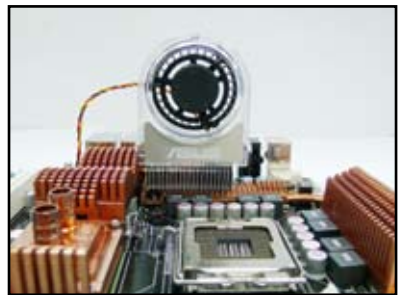
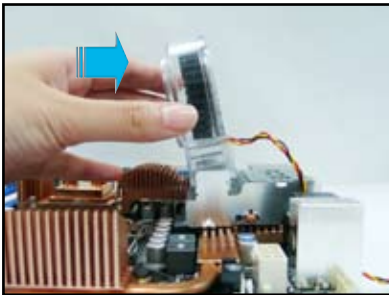

- Plug the optional fan cables to any of the CHA_FAN1, CHA_FAN3, and PWR_FAN connectors on the motherboard.
- Make sure the optional fan is installed correctly to prevent damage to the fan and motherboard components.

2.4 System memory

2.4.1 Overview

The motherboard comes with four Double Data Rate 2 (DDR2) Dual Inline Memory Modules (DIMM) sockets.

The figure illustrates the location of the DDR2 DIMM sockets:

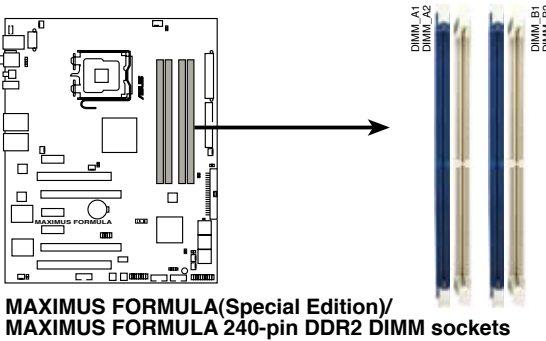

Channel	Sockets
Channel A	DIMM_A1 and DIMM_A2
Channel B	DIMM_B1 and DIMM_B2



- This chipset officially supports DDR2-800 MHz. With the ASUS Super Memspeed Technology, this motherboard natively supports up to DDR2-1066 MHz. See the table below.

FSB	DDR2
1333	1066*
1333	800
1333	667
1066	1066*
1066	800
1066	667

- *If you install a DDR2-1066 memory module, make sure that you set the **DRAM Frequency** item in BIOS to [DDR2-1066MHz]. See section 4.4 **Extreme Tweaker menu** for details.

2.4.2 Memory configurations

You may install 256 MB, 512 MB, 1 GB, and 2 GB unbuffered ECC and non-ECC DDR2 DIMMs into the DIMM sockets.

Recommended Memory Configurations

Mode	Sockets			
	DIMM_A1	DIMM_A2	DIMM_B1	DIMM_B2
Single-Channel	Populated	–	–	–
	–	–	Populated	–
Dual-channel (1)	Populated	–	Populated	–
Dual-channel (2)	Populated	Populated	Populated	Populated



- You may install varying memory sizes in Channel A and Channel B. The system maps the total size of the lower-sized channel for the dual-channel configuration. Any excess memory from the higher-sized channel is then mapped for single-channel operation.
- Always install DIMMs with the same CAS latency. For optimum compatibility, it is recommended that you obtain memory modules from the same vendor.
- If you install four 1 GB memory modules, the system may only recognize less than 3GB because the address space is reserved for other critical functions. This limitation appears on Windows® XP/Vista 32-bit operation system which does not support Physical Address Extension (PAE).
- If you install Windows® XP/Vista 32-bit operation system, a total memory of less than 3GB is recommended.
- This motherboard does not support memory modules made up of 128 Mb chips.



Notes on memory limitations

- Due to chipset limitation, this motherboard can only support up to 8 GB on the operating systems listed below. You may install a maximum of 2 GB DIMMs on each slot.

64-bit

Windows® XP Professional x64 Edition
Windows® Vista x64 Edition

- Some old-version DDR2-800 DIMMs may not match Intel®'s On-Die-Termination (ODT) requirement and will automatically downgrade to run at DDR2-667. If this happens, contact your memory vendor to check the ODT value.
- Due to chipset limitation, DDR2-800 with CL=4 will be downgraded to run at DDR2-667 by default setting. If you want to operate with lower latency, adjust the memory timing manually.

Maximus Formula (Special Edition) / Maximus Formula Motherboard Qualified Vendors Lists (QVL) DDR2-800 MHz capability

Size	Vendor	Chip No.	SS/ DS	Part No.	DIMM support		
					A*	B*	C*
512MB	KINGSTON	K4T51083QC	SS	KVR800D2N5/512	•	•	•
1024MB	KINGSTON	Heat-Sink Package	DS	KHX6400D2LL/1G	•	•	
1024MB	KINGSTON	Heat-Sink Package	SS	KHX6400D2LLK2/1GN	•		
1024MB	KINGSTON	V59C1512804QBF25	DS	KVR800D2N5/1G	•	•	•
1024MB	KINGSTON	Heat-Sink Package	SS	KHX6400D2ULK2/1G	•	•	•
2048MB	KINGSTON	Heat-Sink Package	DS	KHX6400D2ULK2/2G	•	•	•
512MB	Qimonda	HYB18T512800BF25F	SS	HYS64T64000HU-25F-B	•	•	•
1024MB	Qimonda	HYB18T512800BF25F	DS	HYS64T128020HU-25F-B	•	•	•
512MB	Hynix	HY5PS12821CFP-S5	SS	HYPM564U64CP8-S5	•	•	•
1024MB	Hynix	HY5PS12821CFP-S5	DS	HYMP512U64CP8-S5	•	•	•
512MB	MICRON	D9GKX	SS	MT8HTF6464AY-80ED4	•	•	•
1024MB	MICRON	D9GKX	DS	MT16HTF12864AY-80ED4	•	•	•
1024MB	CORSAIR	Heat-Sink Package	DS	CM2X1024-6400C4	•	•	•
1024MB	ELPIDA	E1108AB-8E-E(ECC)	SS	EBE10EE8ABFA-8E-E	•	•	•
2048MB	ELPIDA	E1108AB-8E-E(ECC)	DS	EBE21EE8ABFA-8E-E	•	•	•
512MB	Crucial	Heat-Sink Package	SS	BL6464AA804.8FD	•	•	•
1024MB	Crucial	Heat-Sink Package	DS	BL12864AA804.16FD	•	•	•
1024MB	Crucial	Heat-Sink Package	DS	BL12864AL804.16FD3	•	•	•
1024MB	Crucial	Heat-Sink Package	DS	BL12864AA804.16FD3	•	•	•
512MB	Apacer	Heat-Sink Package	DS	AHU512E800C5K1C	•	•	•
1024MB	Apacer	Heat-Sink Package	DS	AHU01GE800C5K1C	•	•	•
512MB	A-DATA	AD29608A8A-25EG	SS	M2OAD6G3H3160G1E53	•	•	
1024MB	A-DATA	AD26908A8A-25EG	DS	M2OAD6G3I41701E58	•		
512MB	KINGMAX	KA8FEIBF-HJK-25A	SS	KLDC28F-A8KI5	•	•	•
1024MB	KINGMAX	KA8FEIBF-HJK-25A	DS	KLDD48F-ABKI5	•	•	
512MB	Transcend	HY5PS12821CFP-S5	SS	TS64MLQ64V8J	•	•	•
1024MB	Transcend	HY5PS12821CFP-S5	DS	TS128MLQ64V8J	•	•	•
512MB	Super Talent	Heat-Sink Package	SS	T800UA12C4	•	•	
1024MB	Super Talent	Heat-Sink Package	DS	T800UB1GC4	•	•	•
512MB	NANYA	NT5TU64M8BE-25C	SS	NT512T64U880BY-25C	•	•	•
1024MB	NANYA	NT5TU64M8BE-25C	DS	NT1GT64U8HB0BY-25C	•	•	•
512MB	PSC	A3R12E3HEF641B9A05	SS	AL6E8E63B8E1K	•	•	•
1024MB	PSC	A3R12E3HEF641B9A05	DS	AL7E8E63B-8E1K	•	•	
256MB	TwinMOS	E2508AB-GE-E	SS	8G-24K2-EBT	•	•	•
1024MB	Elixir	N2TU51280BE-25C	DS	M2Y1G64TU8HB0B-25C	•	•	•



- A*: Supports one module inserted in any slot as Single-channel memory configuration.
- B*: Supports one pair of modules inserted into either the blue slots or the white slots as one pair of Dual-channel memory configuration.
- C*: Supports 4 modules inserted into both the blue and white slots as two pairs of Dual-channel memory configuration.



Visit the ASUS website for the latest DDR2-800/667MHz QVL.

Maximus Formula (Special Edition) / Maximus Formula Motherboard Qualified Vendors Lists (QVL) DDR2-667MHz capability

Size	Vendor	Chip No.	SS/ DS	Part No.	DIMM support		
					A*	B*	C*
256MB	KINGSTON	HYB18T256800AF3S	SS	KVR667D2N5/256	•	•	
256MB	KINGSTON	6SBI2D9DCG	SS	KVR667D2N5/256	•	•	•
512MB	KINGSTON	D6408TEBGGL3U	SS	KVR667D2N5/512	•	•	•
2048MB	KINGSTON	E1108AB-6E-E	DS	KVR667D2N5/2G	•	•	•
1024MB	Qimonda	HYB18T512800BF3S(ECC)	DS	HYS72T128020HU-3S-B	•	•	•
512MB	Qimonda	HYB18T512800BF3S	SS	HYS64T64000HU-3S-B	•	•	
1024MB	Qimonda	HYB18T512800BF3S	DS	HYS64T128020HU-3S-B	•	•	•
256MB	SAMSUNG	K4T51163QE-ZCE6	SS	M378T3354E23-CE6	•	•	•
512MB	SAMSUNG	K4T51083QE	DS	M378T6553EZS-CE6	•	•	•
1024MB	SAMSUNG	K4T51083QE	DS	M378T2953EZ3-CE6	•	•	•
256MB	Hynix	HY5PS121621CFP-Y5	SS	HYPM532U64CP6-Y5	•	•	•
1024MB	Hynix	HY5PS12821CFP-Y5	DS	HYPM512U64CP8-Y5	•	•	•
256MB	CORSAIR	MIII00605	SS	VS256MB667D2	•	•	•
512MB	CORSAIR	64M8CFEG	SS	V5S12MB667D2	•	•	•
1024MB	CORSAIR	64M8CFEG	DS	V51GB667D2	•	•	•
256MB	ELPIDA	E2508AB-6E-E	SS	EBE25UC8ABFA-6E-E	•	•	•
512MB	A-DATA	AD29608A8A-3EG	SS	M20AD5G3H31661C52	•	•	
1024MB	A-DATA	AD29608A8A-3EG	DS	M20AD5G3I41761C52	•	•	
2048MB	A-DATA	NT5TU128M8BJ-3C	DS	M20NY5H3J41701C5Z	•	•	
512MB	crucial	Heat-Sink Package	SS	BL6464AA663.8FD	•		
1024MB	crucial	Heat-Sink Package	DS	BL12864AA663.16FD	•	•	•
1024MB	crucial	Heat-Sink Package	DS	BL12864AL664.16FD	•	•	•
512MB	Apacer	AM4B5708GQJS7E0628F	SS	AU512E667C5KBGC	•	•	•
1024MB	Apacer	AM4B5708GQJS7E	DS	AU01GE667C5KBGC	•	•	•
512MB	Transcend	K4T51083QE	SS	TS64MLQ64V6J	•	•	•
1024MB	Transcend	K4T51083QE	DS	TS128MLQ64V6J	•	•	•
256MB	Kingmax	N2TU51216AG-3C	SS	KLCB68F-36KH5	•	•	•
512MB	Kingmax	KKEA88B4LAUG-29DX	SS	KLCC28F-A8KB5	•	•	•
1024MB	Kingmax	KKEA88B4LAUG-29DX	DS	KLCD48F-A8KB5	•	•	•
512MB	Super Talent	Heat-Sink Package	SS	T6UA512C5	•	•	•
1024MB	Super Talent	Heat-Sink Package	DS	T6UB1GC5	•	•	•
2048MB	NANYA	NT5TU128M8BJ-3C	DS	NT2GT64U8HB0JY-3C	•	•	•
512MB	NANYA	NT5TU64M8BE-3C	SS	NT512T64U88B0BY-3C	•	•	•
512MB	PSC	A3R12E3GEF637BLC5N	SS	AL6E8E63B-6E1K	•	•	•
1024MB	PSC	A3R12E3GEF637BLC5N	DS	AL7E8E63B-6E1K	•	•	•
512MB	TwinMOS	TMM6208G8M30C	SS	8D-23JK5M2ETP	•	•	•

2.4.3 Installing a DIMM



Unplug the power supply before adding or removing DIMMs or other system components. Failure to do so can cause severe damage to both the motherboard and the components.

To install a DIMM:

1. Unlock a DIMM socket by pressing the retaining clips outward.
2. Align a DIMM on the socket such that the notch on the DIMM matches the break on the socket.
3. Firmly insert the DIMM into the socket until the retaining clips snap back in place and the DIMM is properly seated.

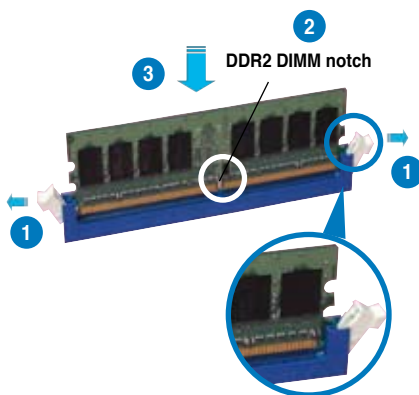

Unlocked retaining clip



- A DDR2 DIMM is keyed with a notch so that it fits in only one direction. Do not force a DIMM into a socket to avoid damaging the DIMM.
- The DDR2 DIMM sockets do not support DDR DIMMs. Do not install DDR DIMMs to the DDR2 DIMM sockets.

2.4.4 Removing a DIMM

To remove a DIMM:

1. Simultaneously press the retaining clips outward to unlock the DIMM.



Support the DIMM lightly with your fingers when pressing the retaining clips. The DIMM might get damaged when it flips out with extra force.

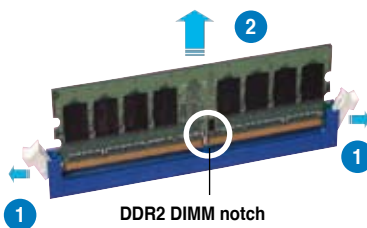

2. Remove the DIMM from the socket.

2.5 Expansion slots

In the future, you may need to install expansion cards. The following sub-sections describe the slots and the expansion cards that they support.



Make sure to unplug the power cord before adding or removing expansion cards. Failure to do so may cause you physical injury and damage motherboard components.

2.5.1 Installing an expansion card

To install an expansion card:

1. Before installing the expansion card, read the documentation that came with it and make the necessary hardware settings for the card.
2. Remove the system unit cover (if your motherboard is already installed in a chassis).
3. Remove the bracket opposite the slot that you intend to use. Keep the screw for later use.
4. Align the card connector with the slot and press firmly until the card is completely seated on the slot.
5. Secure the card to the chassis with the screw you removed earlier.
6. Replace the system cover.

2.5.2 Configuring an expansion card

After installing the expansion card, configure it by adjusting the software settings.

1. Turn on the system and change the necessary BIOS settings, if any. See Chapter 4 for information on BIOS setup.
2. Assign an IRQ to the card. Refer to the tables on the next page.
3. Install the software drivers for the expansion card.



When using PCI cards on shared slots, ensure that the drivers support "Share IRQ" or that the cards do not need IRQ assignments. Otherwise, conflicts will arise between the two PCI groups, making the system unstable and the card inoperable. Refer to the table on the next page for details.

2.5.3 Interrupt assignments

IRQ	Priority	Standard function
0	1	System timer
1	2	Keyboard controller
2	–	Re-direct to IRQ#9
3	11	IRQ holder for PCI steering*
4	12	Communications port (COM1)*
5	13	IRQ holder for PCI steering*
6	14	Floppy disk controller
7	15	Printer port (LPT1)*
8	3	System CMOS/Real Time Clock
9	4	IRQ holder for PCI steering*
10	5	IRQ holder for PCI steering*
11	6	IRQ holder for PCI steering*
12	7	PS/2 compatible mouse port*
13	8	Numeric data processor
14	9	SATA Primary IDE (legacy mode)
15	10	SATA Secondary IDE (legacy mode)

* These IRQs are usually available for PCI devices.

IRQ assignments for this motherboard

	A	B	C	D	E	F	G	H
PCI slot 1	shared	–	–	–	–	–	–	–
PCI slot 2	–	shared	–	–	–	–	–	–
LAN (8056)	shared	–	–	–	–	–	–	–
SATA (368)	shared	–	–	–	–	–	–	–
LAN (8056)	–	shared	–	–	–	–	–	–
PCIe x16_1	shared	–	–	–	–	–	–	–
PCIe x16_2	shared	–	–	–	–	–	–	–
PCIe x1_1	–	shared	–	–	–	–	–	–
PCIe x1_2	shared	–	–	–	–	–	–	–
PCIe x1_3	–	–	shared	–	–	–	–	–
USB controller 1	–	–	–	–	–	–	–	shared
USB controller 2	–	–	–	shared	–	–	–	–
USB controller 3	–	–	shared	–	–	–	–	–
USB controller 4	shared	–	–	–	–	–	–	–
USB controller 5	–	–	–	–	–	shared	–	–
USB controller 6	–	–	shared	–	–	–	–	–
USB 2.0 controller 1	–	–	–	–	–	–	–	shared
USB 2.0 controller 2	–	–	shared	–	–	–	–	–
SATA controller 1	–	–	–	–	–	–	shared	–
SATA controller 2	–	–	–	–	–	–	shared	–

2.5.4 PCI slots

The PCI slots support cards such as a LAN card, SCSI card, USB card, and other cards that comply with PCI specifications. Refer to the figure below for the location of the slots.

2.5.5 PCI Express x1 slots

This motherboard supports PCI Express x1 network cards, SCSI cards and other cards that comply with the PCI Express specifications. Refer to the figure below for the location of the slots.



- Install the audio card prior to other compatible cards to the black PCIe x1 slot.
- Install a PCIe x1 device to a PCIe x1 slot prior to a PCIe x16 slot.

2.5.6 PCI Express x16 slots

This motherboard supports two ATI CrossFire™ PCI Express x16 graphics cards that comply with the PCI Express specifications. Refer to the figure below for the location of the slots.

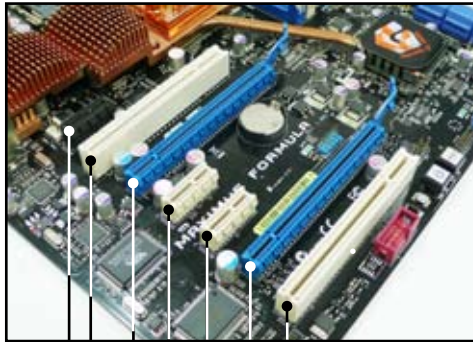

Audio/PCI Express x1 slot
PCI slot
PCI Express x16 slot
PCI Express x16 slot
PCI Express x1 slot
PCI slot



- In CrossFire™ mode, install the ATI CrossFire™ Edition (Master) graphics card on the primary PCI Express slot.
- Install two ATI graphics cards from the same GPU family that support CrossFire™ mode.
- If you install two VGA cards, we recommend that you plug the rear chassis fan cable to the motherboard connector labeled CHA_FAN1/3 for better thermal environment. See page 2-36 for the connector location.

2.6 Switch

1. Clear RTC RAM (3-pin CLRRTC_SW)

This onboard switch allows you to enable the **clr CMOS** switch on the back I/O. You can clear the CMOS memory and system setup parameters by erasing the CMOS RTC RAM data. The **clr CMOS** switch on the back I/O helps you easily to clear the system setup information such as system passwords.

To erase the RTC RAM:

1. Press down the **clr CMOS** switch on the back I/O.
2. Hold down the key during the boot process and enter BIOS setup to re-enter data.

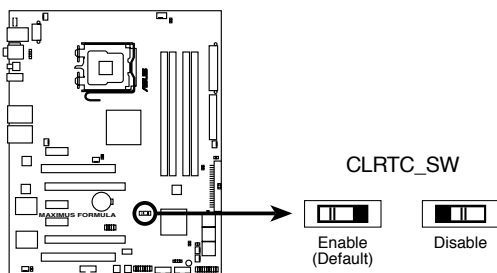

**MAXIMUS FORMULA(Special Edition)/
MAXIMUS FORMULA Clear RTC RAM**

clr CMOS switch behavior

System power state	G3*	S5*	S0 (DOS mode)	S0 (OS mode)	S1	S3	S4
Clearing CMOS	•	•	•**				

*G3: Power off without +5VSB power (AC power loss); S5: Power off with +5VSB power

**The system shuts down immediately.



- The **clr CMOS** switch will not function if the CLRRTC_SW switch is moved to the Disable position, but the shutdown function in S0 mode (DOS mode) still works.
- Make sure to re-enter your previous BIOS settings after you clear the CMOS.
- You do not need to clear the RTC when the system hangs due to CPU overclocking. With the C.P.R. (CPU Parameter Recall) feature, shut down and reboot the system so the BIOS can automatically reset CPU parameter settings to default values. If the system hangs due to overclocking of memory timing or chipset voltage and the power button fails to function, pressing down the **clr CMOS** switch will shut down the system and clear CMOS simultaneously.

2.7 Audio card, I/O shield, and LCD Poster installation

2.7.1 Audio card Installation

1. Take out the Audio card from the package.
2. Locate the audio slot on the motherboard.

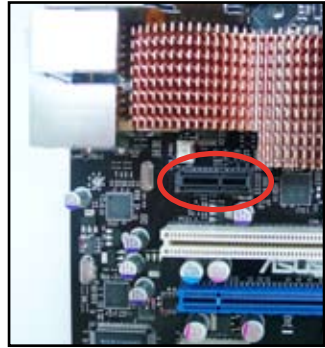

3. Align the card connector with the slot and press firmly until the card sits on the slot completely.
4. The photo below shows the audio card installed on the motherboard.



2.7.2 I/O shield and LCD Poster Installation

1. Install the I/O shield to the chassis rear panel. Orient the I/O shield so that the openings of the ports fit the motherboard rear ports. Snaps the I/O shield into place.
2. Position the motherboard I/O side toward the chassis rear panel and install the motherboard to the chassis.



Be cautious when installing the I/O shield. The I/O shield edge springs may damage the I/O ports.



3. Thread the LCD Poster cable through the opening until its stopper snaps into place.



4. Plug the LCD Poster cable into the onboard connector labeled LCD_CON.

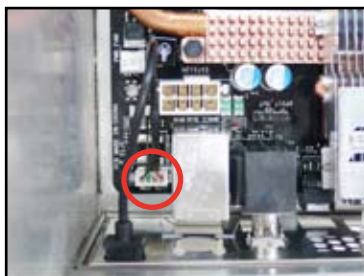

5. This photo shows the LCD Poster installed. Place the device wherever you can monitor the screen.



2.8 Connectors

2.8.1 Rear panel connectors

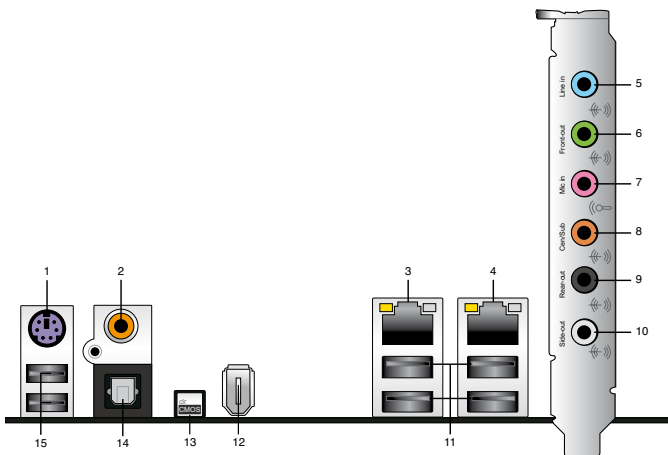

1. **PS/2 keyboard port (purple).** This port is for a PS/2 keyboard.
2. **Coaxial S/PDIF Out port.** This port connects an external audio output device via a coaxial S/PDIF cable.
3. **LAN 2 (RJ-45) port.** This port allows Gigabit connection to a Local Area Network (LAN) through a network hub. Refer to the table below for the LAN port LED indications.
4. **LAN 1 (RJ-45) port.** This port allows Gigabit connection to a Local Area Network (LAN) through a network hub. Refer to the table below for the LAN port LED indications.

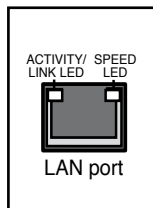

32-bit OS LAN port LED indications

Activity/Link	Speed LED	Description
OFF	OFF	Soft-off Mode
YELLOW*	OFF	During Power ON/OFF
YELLOW*	ORANGE	100 Mbps connection

* Blinking

64-bit OS LAN port LED indications

Activity/Link	Speed LED	Description
OFF	OFF	Soft-off Mode
YELLOW*	OFF	During Power ON/OFF
YELLOW*	ORANGE	100 Mbps connection
YELLOW*	GREEN	1 Gbps connection

* Blinking

5. **Line In port (light blue).** This port connects the tape, CD, DVD player, or other audio sources.
6. **Line Out port (lime).** This port connects a headphone or a speaker. In 4-channel, 6-channel, and 8-channel configuration, the function of this port becomes Front Speaker Out.
7. **Microphone port (pink).** This port connects a microphone.
8. **Center/Subwoofer port (orange).** This port connects the center/subwoofer speakers.
9. **Rear Speaker Out port (black).** This port connects the rear speakers on a 4-channel, 6-channel, or 8-channel audio configuration.
10. **Side Speaker Out port (gray).** This port connects the side speakers in an 8-channel audio configuration.



Refer to the audio configuration table on the next page for the function of the audio ports in 2, 4, 6, or 8-channel configuration.

Audio 2, 4, 6, or 8-channel configuration

Port	Headset 2-channel	4-channel	6-channel	8-channel
Light Blue	Line In	Line In	Line In	Line In
Lime	Line Out	Front Speaker Out	Front Speaker Out	Front Speaker Out
Pink	Mic In	Mic In	Mic In	Mic In
Orange	–	–	Center/Subwoofer	Center/Subwoofer
Black	–	Rear Speaker Out	Rear Speaker Ou	Rear Speaker Out
Gray	–	–	–	Side Speaker Out

11. **USB 2.0 ports 1, 2, 3 and 4.** These 4-pin Universal Serial Bus (USB) ports are available for connecting USB 2.0 devices.
12. **IEEE 1394a port.** This 6-pin IEEE 1394a port provides high-speed connectivity for audio/video devices, storage peripherals, PCs, or portable devices.
13. **Clear CMOS switch.** Press the clear CMOS switch to clear setup information when the system hangs due to overclocking.
14. **Optical S/PDIF Out port.** This port connects an external audio output device via an optical S/PDIF cable.
15. **USB 2.0 ports 5 and 6.** These 4-pin Universal Serial Bus (USB) ports are available for connecting USB 2.0 devices.

2.8.2 Internal connectors

1. Floppy disk drive connector (34-1 pin FLOPPY)

This connector is for the provided floppy disk drive (FDD) signal cable. Insert one end of the cable to this connector, then connect the other end to the signal connector at the back of the floppy disk drive.



Pin 5 on the connector is removed to prevent incorrect cable connection when using a FDD cable with a covered Pin 5.

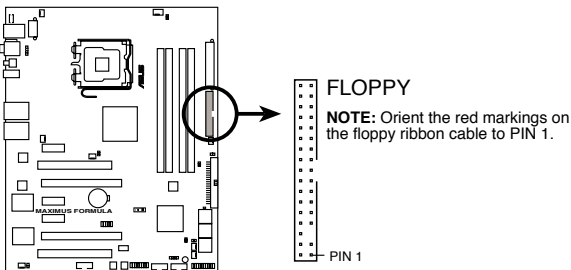

**MAXIMUS FORMULA(Special Edition)/
MAXIMUS FORMULA Floppy disk drive connector**

2. IDE connector (40-1 pin PRI_EIDE)

The onboard IDE connector is for the Ultra DMA 133/100/66 signal cable. There are three connectors on each Ultra DMA 133/100/66 signal cable: blue, black, and gray. Connect the blue connector to the motherboard's IDE connector, then select one of the following modes to configure your device.

	Drive jumper setting	Mode of device(s)	Cable connector
Single device	Cable-Select or Master	-	Black
Two devices	Cable-Select	Master	Black
		Slave	Gray
	Master	Master	Black or gray
	Slave	Slave	



- Pin 20 on the IDE connector is removed to match the covered hole on the Ultra DMA cable connector. This prevents incorrect insertion when you connect the IDE cable.
- Use the 80-conductor IDE cable for Ultra DMA 133/100/66 IDE devices.



If any device jumper is set as "Cable-Select," make sure all other device jumpers have the same setting.

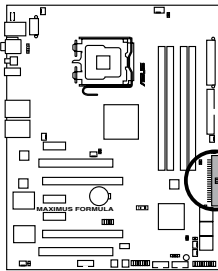

PRI_EIDE
NOTE: Orient the red markings (usually zigzag) on the IDE cable to PIN 1.

**MAXIMUS FORMULA(Special Edition)/
 MAXIMUS FORMULA IDE connector**

3. ICH9R Serial ATA connectors (7-pin SATA1~6)

These connectors are for the Serial ATA signal cables for Serial ATA hard disk drives.

If you installed Serial ATA hard disk drives, you can create a RAID 0, RAID 1, RAID 5, RAID 10 configuration with the Intel® Matrix Storage Technology through the onboard Intel® ICH9R RAID controller.



- These connectors are set to Standard IDE mode by default. In Standard IDE mode, you can connect Serial ATA boot/data hard disk drives to these connectors. If you intend to create a Serial ATA RAID set using these connectors, set the [Configure SATA as] item in the BIOS to [RAID]. See section 4.3.6 **SATA Configuration** for details.
- For RAID 5, use at least three hard disk drives. For RAID 10, use at least four hard disk drives. Use two to four Serial ATA hard disk drives for each RAID 0 or RAID 1 set.
- Before creating a RAID set, refer to 5.4.3 **Intel® RAID configurations** or the manual bundled in the motherboard support DVD.

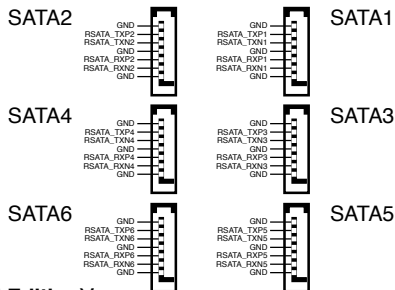
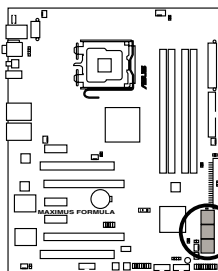

**MAXIMUS FORMULA(Special Edition)/
 MAXIMUS FORMULA SATA connectors**



You must install the Windows® XP Service Pack 1 before using Serial ATA hard disk drives. The Serial ATA RAID feature (RAID 0/RAID 1/RAID 5/RAID 10) is available only if you are using Windows® XP or later version.



Connect the right-angle side of SATA signal cable to SATA device. Or you may connect the right-angle side of SATA cable to the onboard SATA port to avoid mechanical conflict with huge graphics cards.

right angle side

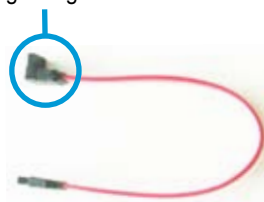

4. USB connectors (10-1 pin USB 78, USB 910, USB 1112)

These connectors are for USB 2.0 ports. Connect the USB module cable to any of these connectors, then install the module to a slot opening at the back of the system chassis. These USB connectors comply with USB 2.0 specification that supports up to 480 Mbps connection speed.

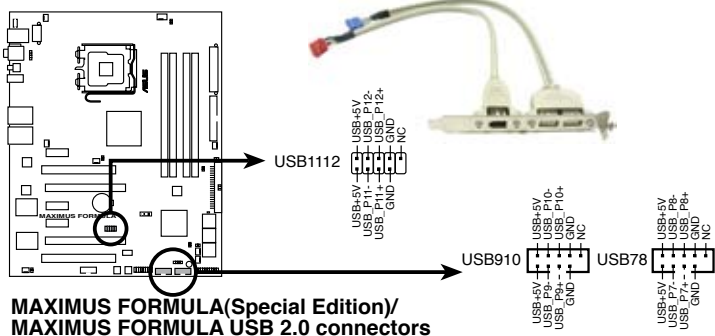

Never connect a 1394 cable to the USB connectors. Doing so will damage the motherboard!



You can connect the USB cable to ASUS Q-Connector (USB, blue) first, and then install the Q-Connector (USB) to the USB connector onboard.

5. IEEE 1394a port connector (10-1 pin IE1394_2)

This connector is for a IEEE 1394a port. Connect the IEEE 1394a module cable to this connector, then install the module to a slot opening at the back of the system chassis.

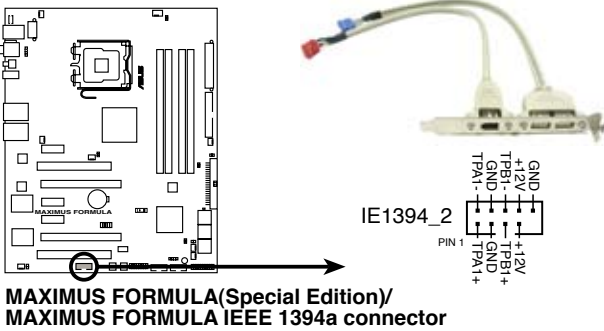

Never connect a USB cable to the IEEE 1394a connector. Doing so will damage the motherboard!



You can connect the 1394 cable to ASUS Q-Connector (1394, red) first, and then install the Q-Connector (1394) to the 1394 connector onboard.

6. Thermal sensor cable connectors (2-pin OPT_TEMP1/2/3)

These connectors are for temperature monitoring. Connect the thermal sensor cables to these connectors and place the other ends to the devices which you want to monitor temperature. The optional fan1/2/3 can work with the temperature sensors for a better cooling effect.

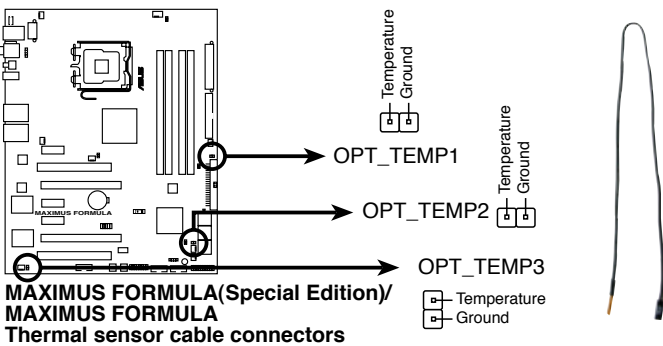

Remove the thermal sensor cable from the assigned device when you set the **South Bridge Sensor Select** item in BIOS to [SB Overheat Protection]. Refer to page 4-31 for details.



The thermal sensor cable is purchased separately.

7. CPU, chassis, and optional fan connectors
(4-pin CPU_FAN, 3-pin CHA_FAN1~3, 3-pin PWR_FAN,
3-pin OPT_FAN1~3)

The fan connectors support cooling fans of 350 mA~1000 mA (24 W max.) or a total of 1 A~3.48 A (41.76 W max.) at +12V. Connect the fan cables to the fan connectors on the motherboard, making sure that the black wire of each cable matches the ground pin of the connector.



DO NOT forget to connect the fan cables to the fan connectors. Insufficient air flow inside the system may damage the motherboard components. These are not jumpers! DO NOT place jumper caps on the fan connectors!

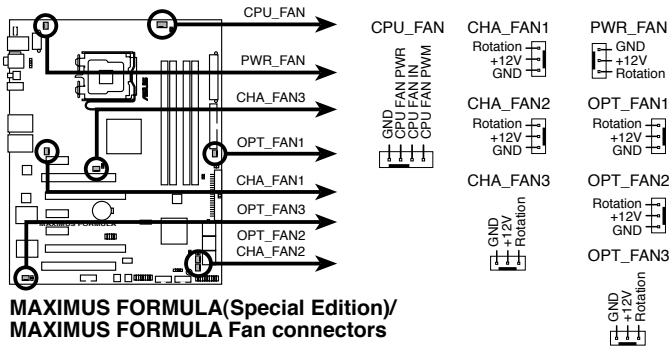

- Only the CPU_FAN, CHA_FAN1~3, and OPT_FAN1~3 connectors support the ASUS Q-Fan 2 feature.
- If you install two VGA cards, we recommend that you plug the chassis fan cable to the motherboard connector labeled CHA_FAN1 or CHA_FAN3 for better thermal environment.

8. Chassis intrusion connector (4-1 pin CHASSIS)

This connector is for a chassis-mounted intrusion detection sensor or switch. Connect one end of the chassis intrusion sensor or switch cable to this connector. The chassis intrusion sensor or switch sends a high-level signal to this connector when a chassis component is removed or replaced. The signal is then generated as a chassis intrusion event.

By default , the pin labeled “Chassis Signal” and “Ground” are shorted with a jumper cap. Remove the jumper caps only when you intend to use the chassis intrusion detection feature.

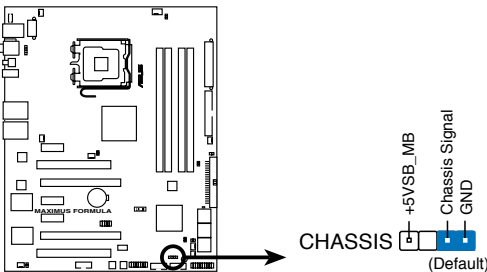

**MAXIMUS FORMULA(Special Edition)/
MAXIMUS FORMULA Chassis intrusion connector**

9. ATX power connectors (24-pin EATXPWR, 8-pin EATX12V)

These connectors are for ATX power supply plugs. The power supply plugs are designed to fit these connectors in only one orientation. Find the proper orientation and push down firmly until the connectors completely fit.

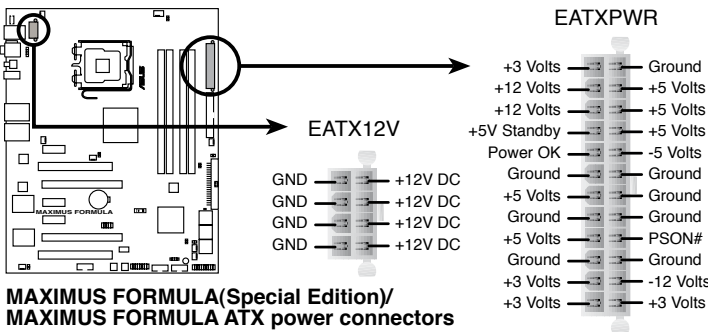

**MAXIMUS FORMULA(Special Edition)/
MAXIMUS FORMULA ATX power connectors**



- Make sure to remove the cap on the EATX12V connector before connecting an 8-pin EPS +12V power plug.
- Use only an 8-pin EPS +12V power plug for the EATX12V connector.



- For a fully configured system, we recommend that you use a power supply unit (PSU) that complies with ATX 12 V Specification 2.0 (or later version) and provides a minimum power of 400 W.
- Do not forget to connect the 4-pin/8pin EATX12V power plug; otherwise, the system will not boot.
- Use of a PSU with a higher power output is recommended when configuring a system with more power-consuming devices. The system may become unstable or may not boot up if the power is inadequate.
- If you are uncertain about the minimum power supply requirement for your system, refer to the **Recommended Power Supply Wattage Calculator** at <http://support.asus.com/PowerSupplyCalculator/PSCalculator.aspx?SLanguage=en-us> for details.
- The ATX 12 V Specification 2.0-compliant (400W) PSU has been tested to support the motherboard power requirements with the following configuration:
 - CPU: Intel® Pentium® Extreme 3.73GHz
 - Memory: 512 MB DDR2 (x4)
 - Graphics card: ASUS EAX1900XT
 - Parallel ATA device: IDE hard disk drive
 - Serial ATA device: SATA hard disk drive (x2)
 - Optical drive: DVD-RW
- If you want to use two high-end PCI Express x16 cards, use a PSU with 500W to 600W power or above to ensure the system stability.

10. Digital audio connector (4-1 pin SPDIF_OUT for ASUS HDMI VGA card)

This connector is for an additional Sony/Philips Digital Interface (S/PDIF) port(s). If you are using an ASUS HDMI-equipped graphics card, connect the HDMI card to this connector with a S/PDIF Out cable.

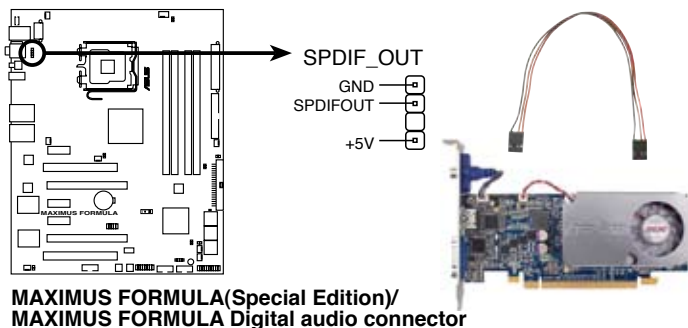

The ASUS HDMI-equipped graphics card and the S/PDIF Out cable are purchased separately.

11. System panel connector (20-8 pin PANEL)

This connector supports several chassis-mounted functions.

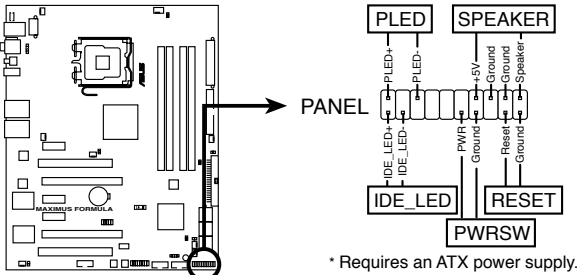

**MAXIMUS FORMULA(Special Edition)/
MAXIMUS FORMULA System panel connector**

- **System power LED (2-pin PLED)**

This 2-pin connector is for the system power LED. Connect the chassis power LED cable to this connector. The system power LED lights up when you turn on the system power, and blinks when the system is in sleep mode.

- **Hard disk drive activity LED (2-pin IDE_LED)**

This 2-pin connector is for the HDD Activity LED. Connect the HDD Activity LED cable to this connector. The IDE LED lights up or flashes when data is read from or written to the HDD.

- **System warning speaker (4-pin SPEAKER)**

This 4-pin connector is for the chassis-mounted system warning speaker. The speaker allows you to hear system beeps and warnings.

- **ATX power button/soft-off button (2-pin PWRSW)**

This connector is for the system power button. Pressing the power button turns the system on or puts the system in sleep or soft-off mode depending on the BIOS settings. Pressing the power switch for more than four seconds while the system is ON turns the system OFF.

- **Reset button (2-pin RESET)**

This 2-pin connector is for the chassis-mounted reset button for system reboot without turning off the system power.

ASUS Q-Connector (system panel)

You can use the ASUS Q-Connector to connect/disconnect chassis front panel cables in a few steps. Refer to the instructions below to install the ASUS Q-Connector.

1. Connect the front panel cables to the ASUS Q-Connector.

Refer to the labels on the Q-Connector to know the detailed pin definitions, then match them to the respective front panel cable labels.

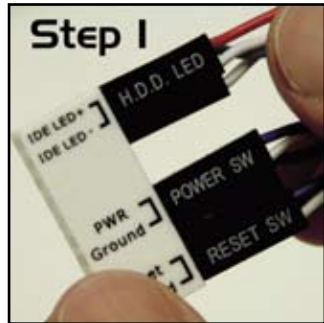

2. Install the ASUS Q-Connector to the system panel connector, making sure the orientation matches the labels on the motherboard.

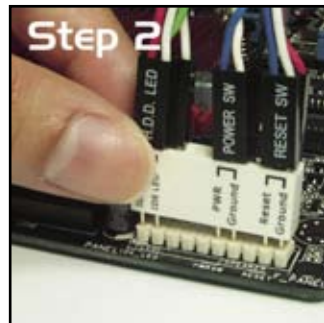

3. The front panel functions are now enabled. The figure shows the Q-Connector properly installed on the motherboard.

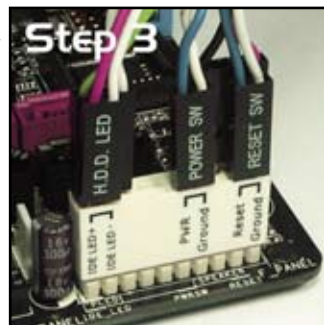

2.8.3 Onboard switches

Onboard switches allow you to fine-tune performance when working on a bare or open-case system. This is ideal for overclockers and gamers who continually change settings to enhance system performance.

1. Power-on switch

Press the power-on switch to wake/power up the system.

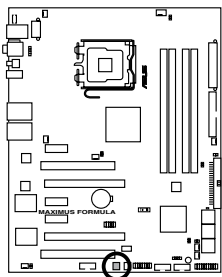

**MAXIMUS FORMULA(Special Edition)/
MAXIMUS FORMULA Power on switch**

2. Reset switch

Press the reset switch to reboot the system.

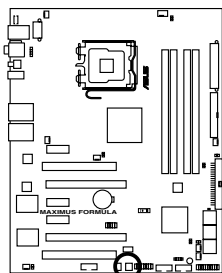





**MAXIMUS FORMULA(Special Edition)/
MAXIMUS FORMULA Reset switch**

2.8.4 Installing Fusion Block System accessory

Install your watercooling system to the motherboard using the bundled accessories to obtain the best thermal solution.

Package contents

		
3/8" ID tubes x 2	1/2" to 3/8" ID fittings x 2	10mm to 3/8" ID fittings x 2
		
1/2" ID tube clips x 2	3/8" ID tube clips x 6	

For watercooling system with 3/8" ID tubes

1. Firmly press a tube clip and fit the tube into the clip.
2. Press the clip and connect the tube to the waterblock. When done, release the clip to tighten the two together.
3. Repeat Step 1 and 2 for another tube. Make sure that both tubes are well connected to prevent leak, and then fill the coolant into the reservoir.

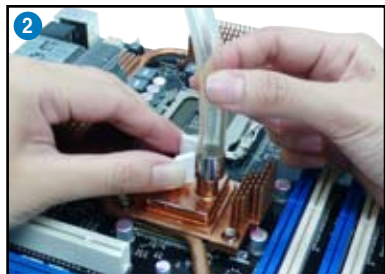

For watercooling system with 1/2" or 10mm ID tubes

1. Insert a fitting (1/2" to 3/8" ID or 10mm to 3/8" ID) into the tube.



Your watercooling system may come with tube clips. Use the clips to fasten the fittings and the tubes together.

2. Connect a supplied 3/8" ID tube to the fitting.
3. Firmly press a tube clip and hitch it to the bottom end of the 3/8" ID tube.
4. Press another clip and hitch it to the top end of the 3/8" ID tube.

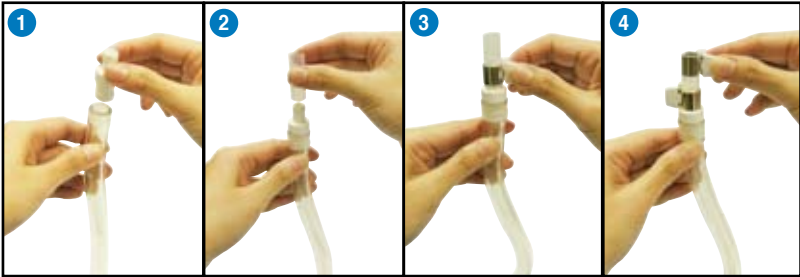

5. Press the clip and connect the assembled tube to the waterblock. When done, release the clip to tighten the two together.
6. Repeat Step 1 to 5 for another tube. Make sure that both tubes are well connected to prevent leak, and then fill the coolant into the reservoir. The picture shows a watercooling system installed to the motherboard.

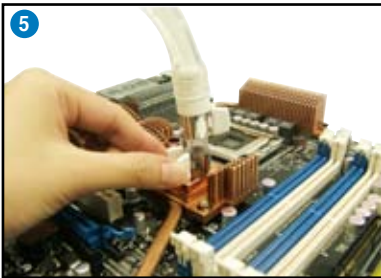

This chapter describes the power up sequence, the vocal POST messages, and ways of shutting down the system.

Powering up **3**

Chapter summary

3

3.1	Starting up for the first time.....	3-1
3.2	Turning off the computer.....	3-2

3.1 Starting up for the first time

1. After making all the connections, replace the system case cover.
2. Be sure that all switches are off.
3. Connect the power cord to the power connector at the back of the system chassis.
4. Connect the power cord to a power outlet that is equipped with a surge protector.
5. Turn on the devices in the following order:
 - a. Monitor
 - b. External SCSI devices (starting with the last device on the chain)
 - c. System power
6. After applying power, the system power LED on the system front panel case lights up. For systems with ATX power supplies, the system LED lights up when you press the ATX power button. If your monitor complies with “green” standards or if it has a “power standby” feature, the monitor LED may light up or switch between orange and green after the system LED turns on.

The system then runs the power-on self tests or POST. While the tests are running, the BIOS beeps (see BIOS beep codes table below) or additional messages appear on the screen. If you do not see anything within 30 seconds from the time you turned on the power, the system may have failed a power-on test. Check the jumper settings and connections or call your retailer for assistance.

BIOS Beep	Description
One short beep	VGA detected Quick boot set to disabled No keyboard detected
One continuous beep followed by two short beeps then a pause (repeated)	No memory detected
One continuous beep followed by three short beeps	No VGA detected
One continuous beep followed by four short beeps	Hardware component failure

7. At power on, hold down the <Delete> key to enter the BIOS Setup. Follow the instructions in Chapter 4.

3.2 Turning off the computer

3.2.1 Using the OS shut down function

If you are using Windows® XP:

1. Click the **Start** button then select **Turn Off Computer**.
2. Click the **Turn Off** button to shut down the computer.
3. The power supply should turn off after Windows® shuts down.

If you are using Windows® Vista™:

1. Click the **Start** button then select **ShutDown**.
2. The power supply should turn off after Windows® shuts down.

3.2.2 Using the dual function power switch

While the system is ON, pressing the power switch for less than four seconds puts the system to sleep mode or to soft-off mode, depending on the BIOS setting. Pressing the power switch for more than four seconds lets the system enter the soft-off mode regardless of the BIOS setting. Refer to section **4.6 Power Menu** in Chapter 4 for details.

This chapter tells how to change the system settings through the BIOS Setup menus. Detailed descriptions of the BIOS parameters are also provided.

BIOS setup **4**

4.1	Managing and updating your BIOS	4-1
4.2	BIOS setup program	4-9
4.3	Main menu	4-12
4.4	Extreme Tweaker menu	4-17
4.5	Advanced menu	4-23
4.6	Power menu	4-29
4.7	Boot menu	4-34
4.8	Tools menu	4-38
4.9	Exit menu	4-41

4.1 Managing and updating your BIOS

The following utilities allow you to manage and update the motherboard Basic Input/Output System (BIOS) setup.

1. **ASUS Update** (Updates the BIOS in Windows® environment.)
2. **ASUS EZ Flash 2** (Updates the BIOS using a floppy disk or USB flash disk.)
3. **ASUS AFUDOS** (Updates the BIOS using a bootable floppy disk.)
4. **ASUS CrashFree BIOS 3** (Updates the BIOS using a bootable USB flash disk or the motherboard support DVD when the BIOS file fails or gets corrupted.)

Refer to the corresponding sections for details on these utilities.



Save a copy of the original motherboard BIOS file to a bootable floppy disk or USB flash disk in case you need to restore the BIOS in the future. Copy the original motherboard BIOS using the ASUS Update or AFUDOS utilities.

4.1.1 ASUS Update utility

The ASUS Update is a utility that allows you to manage, save, and update the motherboard BIOS in Windows® environment. The ASUS Update utility allows you to:

- Save the current BIOS file
- Download the latest BIOS file from the Internet
- Update the BIOS from an updated BIOS file
- Update the BIOS directly from the Internet, and
- View the BIOS version information.

This utility is available in the support DVD that comes with the motherboard package.



ASUS Update requires an Internet connection either through a network or an Internet Service Provider (ISP).

Installing ASUS Update

To install ASUS Update:

1. Place the support DVD in the optical drive. The Drivers menu appears.
2. Click the Utilities tab, then click Install ASUS Update VX.XX.XX.
3. The ASUS Update utility is copied to your system.



Quit all Windows® applications before you update the BIOS using this utility.

Updating the BIOS through the Internet

To update the BIOS through the Internet:

1. Launch the ASUS Update utility from the Windows® desktop by clicking **Start > Programs > ASUS > ASUSUpdate > ASUSUpdate**. The ASUS Update main window appears.



2. Select **Update BIOS** from the Internet option from the drop-down menu, then click **Next**.
3. Select the ASUS FTP site nearest you to avoid network traffic, or click **Auto Select**. Click **Next**.

- From the FTP site, select the BIOS version that you wish to download. Click **Next**.
- Follow the screen instructions to complete the update process.



The ASUS Update utility is capable of updating itself through the Internet. Always update the utility to avail all its features.



Updating the BIOS through a BIOS file

To update the BIOS through a BIOS file:

- Launch the ASUS Update utility from the Windows® desktop by clicking **Start > Programs > ASUS > ASUSUpdate > ASUSUpdate**. The ASUS Update main window appears.
- Select Update BIOS from a file option from the drop-down menu, then click **Next**.



- Locate the BIOS file from the Open window, then click **Open**.
- Follow the screen instructions to complete the update process.

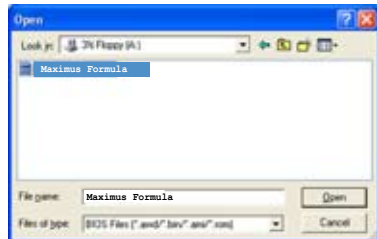

4.1.2 Creating a bootable floppy disk

1. Do either one of the following to create a bootable floppy disk.

DOS environment

- a. Insert a 1.44MB floppy disk into the drive.
- b. At the DOS prompt, type `format a: /s` then press <Enter>.

Windows® XP environment

- a. Insert a 1.44 MB floppy disk to the floppy disk drive.
 - b. Click **Start** from the Windows® desktop, then select **My Computer**.
 - c. Select the 3 1/2 Floppy Drive icon.
 - d. Click File from the menu, then select **Format**. A **Format 3 1/2 Floppy Disk** window appears.
 - e. Select **Create an MS-DOS startup disk** from the format options field, then click **Start**.
2. Copy the original or the latest motherboard BIOS file to the bootable floppy disk.

4.1.3 ASUS EZ Flash 2 utility

The ASUS EZ Flash 2 feature allows you to update the BIOS without having to go through the long process of booting from a floppy disk and using a DOS-based utility. The EZ Flash 2 utility is built-in the BIOS chip so it is accessible by pressing <Alt> + <F2> during the Power-On Self Tests (POST).

To update the BIOS using EZ Flash 2:

1. Visit the ASUS website (www.asus.com) to download the latest BIOS file for the motherboard.
2. Save the BIOS file to a floppy disk or a USB flash disk, then restart the system.
3. You can launch the EZ Flash 2 by two methods.
 - (1) Insert the floppy disk / USB flash disk that contains the BIOS file to the floppy disk drive or the USB port.

Press <Alt> + <F2> during POST to display the following.

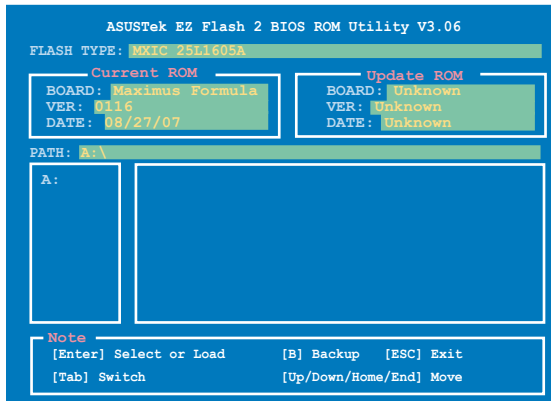

- (2) Enter BIOS setup program. Go to the **Tools** menu to select **EZ Flash2** and press <Enter> to enable it.
You can switch between drives by pressing <Tab> before the correct file is found. Then press <Enter>.
4. When the correct BIOS file is found, EZ Flash 2 performs the BIOS update process and automatically reboots the system when done.



- This function can support devices such as USB flash disk, or floppy disk with **FAT 32/16** format and single partition only.
- DO NOT shut down or reset the system while updating the BIOS to prevent system boot failure!

4.1.4 AFUDOS utility

The AFUDOS utility allows you to update the BIOS file in DOS environment using a bootable floppy disk with the updated BIOS file. This utility also allows you to copy the current BIOS file that you can use as backup when the BIOS fails or gets corrupted during the updating process.

Copying the current BIOS

To copy the current BIOS file using the AFUDOS utility:



- Make sure that the floppy disk is not write-protected and has at least 1024KB free space to save the file.
- The succeeding BIOS screens are for reference only. The actual BIOS screen displays may not be same as shown.

1. Copy the AFUDOS utility (afudos.exe) from the motherboard support DVD to the bootable floppy disk you created earlier.
2. Boot the system in DOS mode, then at the prompt type:

```
afudos /o[filename]
```

where the [filename] is any user-assigned filename not more than eight alphanumeric characters for the main filename and three alphanumeric characters for the extension name.

```
A:\>afudos /oOLDBIOS1.rom
```

Main filename Extension name

3. Press <Enter>. The utility copies the current BIOS file to the floppy disk.

```
A:\>afudos /oOLDBIOS1.rom
AMI Firmware Update Utility - Version 1.19(ASUS V2.07(03.11.24BB))
Copyright (C) 2002 American Megatrends, Inc. All rights reserved.
  Reading flash ..... done
  Write to file..... ok
A:\>
```

The utility returns to the DOS prompt after copying the current BIOS file.

Updating the BIOS file

To update the BIOS file using the AFUDOS utility:

1. Visit the ASUS website (www.asus.com) and download the latest BIOS file for the motherboard. Save the BIOS file to a bootable floppy disk.



Write the BIOS filename on a piece of paper. You need to type the exact BIOS filename at the DOS prompt.

2. Copy the AFUDOS utility (afudos.exe) from the motherboard support DVD to the bootable floppy disk you created earlier.
3. Boot the system in DOS mode, then at the prompt type:

```
afudos /i [filename]
```

where [filename] is the latest or the original BIOS file on the bootable floppy disk.

```
A:\>afudos /iFormula.ROM
```

4. The utility verifies the file and starts updating the BIOS.

```
A:\>afudos /iFormula.ROM
AMI Firmware Update Utility - Version 1.19 (ASUS V2.07 (03.11.24BB))
Copyright (C) 2002 American Megatrends, Inc. All rights reserved.

WARNING!! Do not turn off power during flash BIOS
Reading file ..... done
Reading flash ..... done

Advance Check .....
Erasing flash ..... done
Writing flash ..... 0x0008CC00 (9%)
```



Do not shut down or reset the system while updating the BIOS to prevent system boot failure!

5. The utility returns to the DOS prompt after the BIOS update process is completed. Reboot the system from the hard disk drive.

```
A:\>afudos /iFormula.ROM
AMI Firmware Update Utility - Version 1.19 (ASUS V2.07 (03.11.24BB))
Copyright (C) 2002 American Megatrends, Inc. All rights reserved.

WARNING!! Do not turn off power during flash BIOS
Reading file ..... done
Reading flash ..... done

Advance Check .....
Erasing flash ..... done
Writing flash ..... done
Verifying flash .... done

Please restart your computer

A:\>
```

4.1.5 ASUS CrashFree BIOS 3 utility

The ASUS CrashFree BIOS 3 is an auto recovery tool that allows you to restore the BIOS file when it fails or gets corrupted during the updating process. You can update a corrupted BIOS file using the motherboard support DVD or the USB flash disk that contains the updated BIOS file.



Prepare the motherboard support DVD or the USB flash disk containing the updated motherboard BIOS before using this utility.

Recovering the BIOS from the support DVD

To recover the BIOS from the support DVD:

1. Turn on the system.
2. Insert the motherboard support DVD to the optical drive.
3. The utility displays the following message and automatically checks the DVD for the BIOS file.

```
Bad BIOS checksum. Starting BIOS recovery...  
Checking for floppy...
```

When found, the utility reads the BIOS file and starts flashing the corrupted BIOS file.

```
Bad BIOS checksum. Starting BIOS recovery...  
Checking for floppy...  
Floppy found!  
Reading file "Formula.ROM". Completed.  
Start flashing...
```

4. Restart the system after the utility completes the updating process.

Recovering the BIOS from the USB flash disk

To recover the BIOS from the USB flash disk:

1. Insert the USB flash disk that contains BIOS file to the USB port.
2. Turn on the system.
3. The utility will automatically checks the devices for the BIOS file When found, the utility reads the BIOS file and starts flashing the corrupted BIOS file.
4. Restart the system after the utility completes the updating process.



-
- Only the USB flash disk with FAT 32/16 format and single partition can support ASUS CrashFree BIOS 3. The device size should be smaller than 8GB.
 - DO NOT shut down or reset the system while updating the BIOS! Doing so can cause system boot failure!
-

4.2 BIOS setup program

This motherboard supports a programmable Serial Peripheral Interface (SPI) chip that you can update using the provided utility described in section “4.1 Managing and updating your BIOS.”

Use the BIOS Setup program when you are installing a motherboard, reconfiguring your system, or prompted to “Run Setup.” This section explains how to configure your system using this utility.

Even if you are not prompted to use the Setup program, you can change the configuration of your computer in the future. For example, you can enable the security password feature or change the power management settings. This requires you to reconfigure your system using the BIOS Setup program so that the computer can recognize these changes and record them in the CMOS RAM of the SPI chip.

The SPI chip on the motherboard stores the Setup utility. When you start up the computer, the system provides you with the opportunity to run this program. Press during the Power-On Self-Test (POST) to enter the Setup utility; otherwise, POST continues with its test routines.

If you wish to enter Setup after POST, restart the system by pressing <Ctrl+Alt+Delete>, or by pressing the reset button on the system chassis. You can also restart by turning the system off and then back on. Do this last option only if the first two failed.

The Setup program is designed to make it as easy to use as possible. Being a menu-driven program, it lets you scroll through the various sub-menus and make your selections from the available options using the navigation keys.



-
- The default BIOS settings for this motherboard apply for most conditions to ensure optimum performance. If the system becomes unstable after changing any BIOS settings, load the default settings to ensure system compatibility and stability. Select the **Load Setup Defaults** item under the Exit Menu. See section **4.9 Exit Menu**.
 - The BIOS setup screens shown in this section are for reference purposes only, and may not exactly match what you see on your screen.
 - Visit the ASUS website (www.asus.com) to download the latest BIOS file for this motherboard.
-

4.2.1 BIOS menu screen

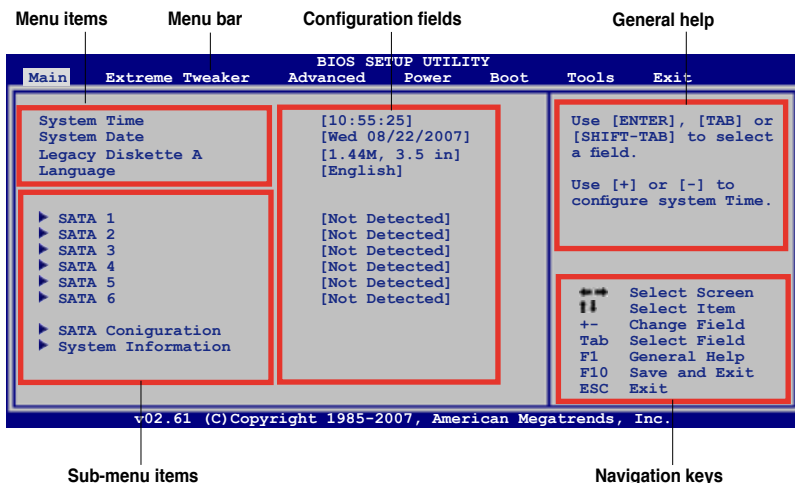

4.2.2 Menu bar

The menu bar on top of the screen has the following main items:

- Main** For changing the basic system configuration
- Extreme Tweaker** For changing the overclocking settings
- Advanced** For changing the advanced system settings
- Power** For changing the advanced power management (APM) configuration
- Boot** For changing the system boot configuration
- Tools** For Configuring options for special functions
- Exit** For selecting the exit options and loading default settings

To select an item on the menu bar, press the right or left arrow key on the keyboard until the desired item is highlighted.

4.2.3 Navigation keys

At the bottom right corner of a menu screen are the navigation keys for that particular menu. Use the navigation keys to select items in the menu and change the settings.



Some of the navigation keys differ from one screen to another.

4.2.4 Menu items

The highlighted item on the menu bar displays the specific items for that menu. For example, selecting Main shows the Main menu items.

The other items (Advanced, Power, Boot, and Exit) on the menu bar have their respective menu items.

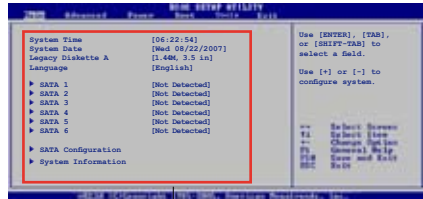

Main menu items

4.2.5 Sub-menu items

A solid triangle before each item on any menu screen means that the item has a sub-menu. To display the sub-menu, select the item and press <Enter>.

4.2.6 Configuration fields

These fields show the values for the menu items. If an item is user-configurable, you can change the value of the field opposite the item. You cannot select an item that is not user-configurable.

A configurable field is enclosed in brackets, and is highlighted when selected. To change the value of a field, select it then press <Enter> to display a list of options. Refer to **4.2.7 Pop-up window**.

4.2.7 Pop-up window

Select a menu item then press <Enter> to display a pop-up window with the configuration options for that item.

4.2.8 Scroll bar

A scroll bar appears on the right side of a menu screen when there are items that do not fit on the screen. Press the Up/Down arrow keys or <Page Up> /<Page Down> keys to display the other items on the screen.

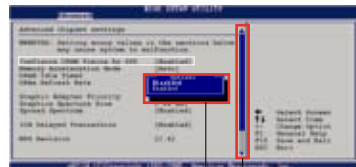

Pop-up window

Scroll bar

4.2.9 General help

At the top right corner of the menu screen is a brief description of the selected item.

4.3 Main menu

When you enter the BIOS Setup program, the Main menu screen appears, giving you an overview of the basic system information.



Refer to section 4.2.1 **BIOS menu screen** for information on the menu screen items and how to navigate through them.

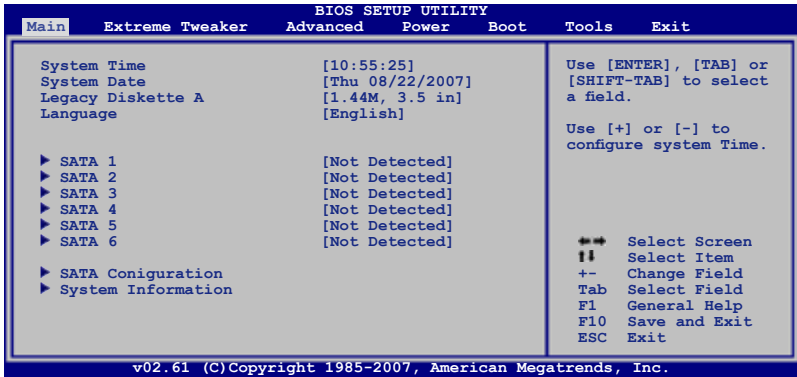

4.3.1 System Time [xx:xx:xx]

Allows you to set the system time.

4.3.2 System Date [Day xx/xx/xxxx]

Allows you to set the system date.

4.3.3 Legacy Diskette A [1.44M, 3.5 in.]

Sets the type of floppy drive installed.

Configuration options: [Disabled] [720K , 3.5 in.] [1.44M, 3.5 in.]

4.3.4 Language [English]

Allows you to choose the BIOS language version from the options.

Configuration options: [Chinese BIG5] [Chinese (GB)] [Japanese] [Français] [German] [English]

4.3.5 SATA 1-6

While entering Setup, the BIOS automatically detects the presence of Serial ATA devices. There is a separate sub-menu for each SATA device. Select a device item then press <Enter> to display the SATA device information.

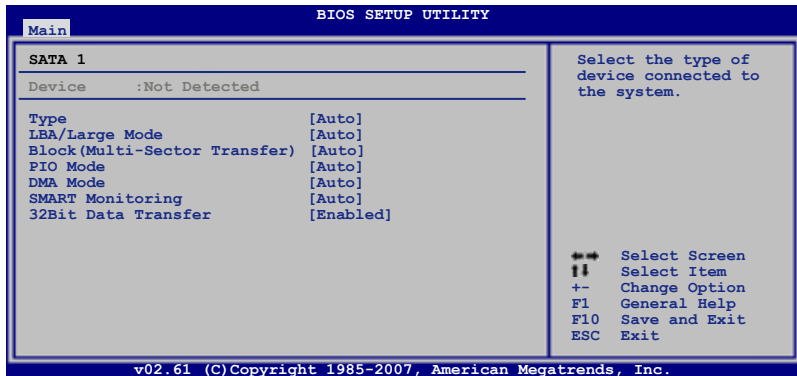

The BIOS automatically detects the values opposite the dimmed items (Device, Vendor, Size, LBA Mode, Block Mode, PIO Mode, Async DMA, Ultra DMA, and SMART monitoring). These values are not user-configurable. These items show [Auto] if no IDE device is installed in the system.

Type [Auto]

Selects the type of IDE drive. Setting to [Auto] allows automatic selection of the appropriate IDE device type. Select [CDROM] if you are specifically configuring a CD-ROM drive. Select [ARMD] (ATAPI Removable Media Device) if your device is either a ZIP, LS-120, or MO drive.

Configuration options: [Not Installed] [Auto] [CDROM] [ARMD]

LBA/Large Mode [Auto]

Enables or disables the LBA mode. Setting to [Auto] enables the LBA mode if the device supports this mode, and if the device was not previously formatted with LBA mode disabled. Configuration options: [Disabled] [Auto]

Block (Multi-sector Transfer) [Auto]

Enables or disables data multi-sectors transfers. When set to [Auto], the data transfer from and to the device occurs multiple sectors at a time if the device supports multi-sector transfer feature. When set to [Disabled], the data transfer from and to the device occurs one sector at a time.

Configuration options: [Disabled] [Auto]

PIO Mode [Auto]

Selects the PIO mode.

Configuration options: [Auto] [0] [1] [2] [3] [4]

DMA Mode [Auto]

Selects the DMA mode. Configuration options: [Auto] [SWDMA0] [SWDMA1] [SWDMA2] [MWDMA0] [MWDMA1] [MWDMA2] [UDMA0] [UDMA1] [UDMA2] [UDMA3] [UDMA4] [UDMA5]

SMART Monitoring [Auto]

Sets the Smart Monitoring, Analysis, and Reporting Technology. Configuration options: [Auto] [Disabled] [Enabled]

32Bit Data Transfer [Enabled]

Enables or disables 32-bit data transfer. Configuration options: [Disabled] [Enabled]

4.3.6 SATA Configuration

The items in this menu allow you to set or change the configurations for the SATA devices installed in the system. Select an item then press <Enter> if you want to configure the item.

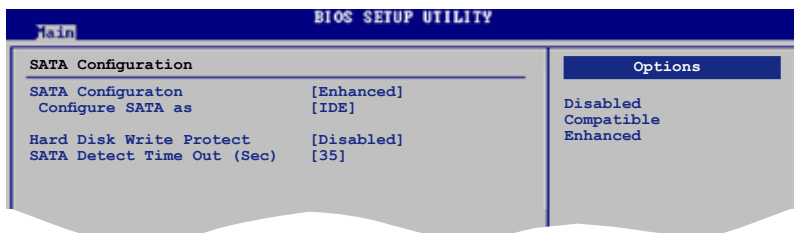

SATA Configuration [Enhanced]

Configuration options: [Disabled] [Compatible] [Enhanced]

Configure SATA as [IDE]

Sets the configuration for the Serial ATA connectors supported by the Southbridge chip.

The AHCI allows the onboard storage driver to enable advanced Serial ATA features that increases storage performance on random workloads by allowing the drive to internally optimize the order of commands.

If you want to create a RAID 0, RAID 1, RAID 5, RAID 10, or the Intel® Matrix Storage Technology configuration from the Serial ATA hard disk drives, set this item to [RAID].

If you want to use the Serial ATA hard disk drives as Parallel ATA physical storage devices, keep the default setting [IDE].

If you want the Serial ATA hard disk drives to use the Advanced Host Controller Interface (AHCI), set this item to [AHCI].

Hard Disk Write Protect [Disabled]

Disables or enables device write protection. This will be effective only if device is accessed through BIOS.

Configuration option: [Disabled] [Enabled]

SATA Detect Time Out (Sec) [35]

Selects the time out value for detecting ATA/ATAPI devices.

Configuration options: [0] [5] [10] [15] [20] [25] [30] [35]

4.3.7 AHCI Configuration

This menu is for AHCI configuration. It appears only when you set the **Configure SATA as** item under **SATA Configuration** to [AHCI].

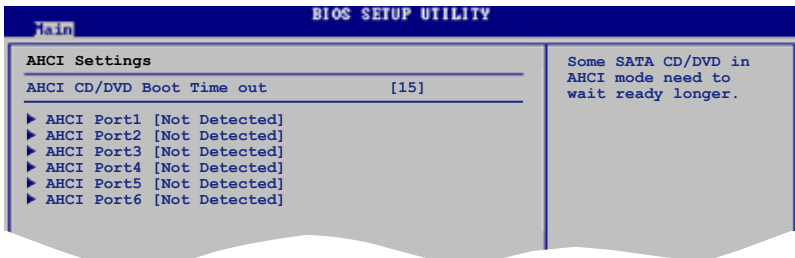

AHCI CD/DVD Boot Time out [15]

Configuration options: [0] [5] [10] [15] [20] [25] [30] [35]

AHCI Port1~6 [XXX]

Displays the auto-detected SATA devices.

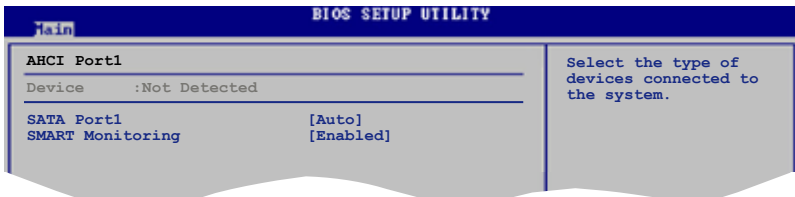

SATA Port1 [Auto]

Allows you to select the type of device connected to the system.

Configuration options: [Auto] [Not Installed]

SMART Monitoring [Enabled]

Enables or disables the Self-Monitoring, Analysis and Reporting Technology (SMART). Configuration options: [Disabled] [Enabled]

4.3.8 System Information

This menu gives you an overview of the general system specifications. The BIOS automatically detects the items in this menu.

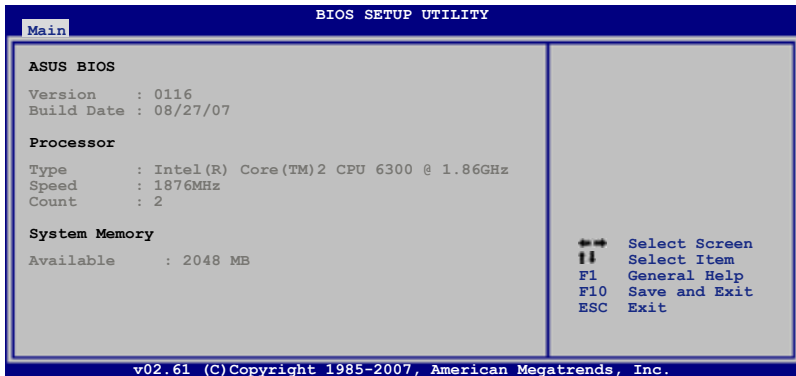

ASUS BIOS

Displays the auto-detected BIOS information.

Processor

Displays the auto-detected CPU specification.

System Memory

Displays the auto-detected system memory.

4.4 Extreme Tweaker menu

The Extreme Tweaker menu items allow you to configure overclocking-related items.



Take caution when changing the settings of the Extreme Tweaker menu items. Incorrect field values can cause the system to malfunction.

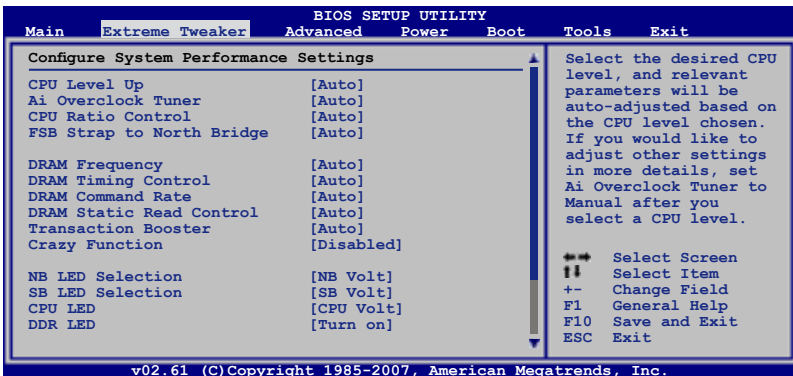

Scroll down to see more items.

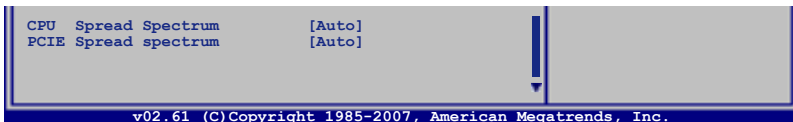

4.4.1 Configure System Performance Settings

CPU Level Up [Auto]

Allows you to select a CPU level, and the related parameters will be automatically adjusted according to the selected CPU level. If you want to manually configure the settings in detail, set **Ai Overclock Tuner** to [Manual] after selecting a CPU level. Configuration options: [Auto] [E6400] [E6550] [E6600] [E6700] [X6800] [E6850] [Crazy]



- The configuration options may vary depending on your CPU type.
- The option [Crazy] appears only when you use a CPU above E6600.

Ai Overclock Tuner [Auto]

Allows selection of CPU overclocking options to achieve desired CPU internal frequency. Select either one of the preset overclocking configuration options:

Manual	Allows you to individually set overclocking parameters.
Auto	Loads the standard settings for the system.
X.M.P	Loads the optimal settings for the system.
CPU Level Up	Allows you to select a CPU level, and the related parameters will be adjusted automatically.



Some of the following items appear when you set **Ai Overclock Tuner** to [Manual] or [X.M.P]. The items vary depending on which option you select.

eXtreme Memory Profile [Profile #1]

Allows you to select the memory profile during overclocking between [Profile #1] (high performance) and [Profile #2] (high frequency). This item appears only when you set **Ai Overclock Tuner** to [X.M.P].

Configuration options: [Profile #1] [Profile #2]

OC From CPU Level Up [Auto]

After you to select a CPU level, the **FSB Frequency** and **DRAM Frequency** items will be adjusted accordingly. This item appears only when you set **Ai Overclock Tuner** to [Manual]. Configuration options: [Auto] [E6400] [E6550] [E6600] [E6700] [X6800] [E6850] [Crazy]



The option [Crazy] appears only when you use a CPU above E6600.

CPU Ratio Control [Auto]

Configuration options: [Auto] [Manual]



The following item appears when the **CPU Ratio Control** item is set to [Manual].

Ratio CMOS Setting [7]

Whether this item is configurable depends on your CPU type. The valid value ranges differently according to your CPU type. If this item is configurable, enter the value using the numeric keypad.

FSB Frequency [XXX]

Displays the frequency sent by the clock generator to the system bus and PCI bus. Use the <+> and <-> keys to adjust the FSB frequency. You can also type the desired FSB frequency using the numeric keypad. The values range from 200 to 800. Refer to the table below for the correct Front Side Bus and CPU External Frequency settings.

FSB/CPU External Frequency Synchronization

Front Side Bus	CPU External Frequency
FSB 1333	333 MHz
FSB 1066	266 MHz
FSB 800	200 MHz

FSB Strap to North Bridge [Auto]

Configuration options: [Auto] [200MHz] [266MHz] [333MHz] [400MHz]

PCIe Frequency [Auto]

Allows you to set the PCI Express frequency.

Configuration options: [100] [101]~[149] [150]

DRAM Frequency [Auto]

Allows you to set the DDR2 operating frequency.

Configuration options: [Auto] [DDR2-667MHz] [DDR2-800 MHz] [DDR2-887MHz] [DDR2-1066MHz]



A very high DRAM frequency may cause the system to become unstable! If this happens, revert to the default setting.



The configuration options may vary depending on the CPU level you select.

DRAM Timing Control [Auto]

Configuration options: [Auto] [Manual]



The following items appear when you set the **DRAM Timing Control** item to [Manual].

CAS# Latency [5 DRAM Clocks]

Configuration options: [3 DRAM Clocks] [4 DRAM Clocks]~[17 DRAM Clocks] [18 DRAM Clocks]

RAS# to CAS# Delay [5 DRAM Clocks]

Configuration options: [3 DRAM Clocks] [4 DRAM Clocks]~[17 DRAM Clocks] [18 DRAM Clocks]

RAS# Precharge [5 DRAM Clocks]

Configuration options: [3 DRAM Clocks] [4 DRAM Clocks]~[17 DRAM Clocks] [18 DRAM Clocks]

RAS# Active Time [15 DRAM Clocks]

Configuration options: [3 DRAM Clocks] [4 DRAM Clocks]~[33 DRAM Clocks] [34 DRAM Clocks]

RAS# to RAS# Delay [Auto]

Configuration options: [Auto] [1 DRAM Clocks]~[15 DRAM Clocks]

ROW Refresh Cycle Time [Auto]

Configuration options: [Auto] [20 DRAM Clocks] [25 DRAM Clocks]
[30 DRAM Clocks] [35 DRAM Clocks] [42 DRAM Clocks]

Write Recovery Time [Auto]

Configuration options: [Auto] [1 DRAM Clocks]~[15 DRAM Clocks]

Write to Read Delay [Auto]

Configuration options: [Auto] [1 DRAM Clocks]~[15 DRAM Clocks]

Read to precharge Time [Auto]

Configuration options: [Auto] [1 DRAM Clocks]~[15 DRAM Clocks]

DRAM Command Rate [Auto]

Configuration options: [Auto] [1T] [2T]

DRAM Static Read Control [Auto]

Configuration options: [Auto] [Disabled] [Enabled]

Transaction Booster [Auto]

Configuration options: [Auto] [Disabled] [Enabled]

Crazy Function [Disabled]

Configuration options: [Disabled] [Crazy 1] [Crazy 2] [Crazy 3] [Crazy 4]

CPU Voltage [Auto]

Allows you to select the CPU voltage. The text color in the configuration field corresponds to the onboard CPU LED color, both of which indicate voltage condition. When you set the **CPU LED** item to [CPU Volt], the onboard CPU LED displays CPU voltage condition. Refer to page 2-1 for CPU LED definition.

Configuration options: [Auto] [1.10000V] [1.10625V] [1.11250V] [1.11875V]
[1.12500V] [1.13125V] [1.13750V] [1.14375V] [1.15000V] [1.15625V] [1.16250V]
[1.16875V] [1.17500V] [1.18125V] [1.18750V] [1.19375V] [1.20000V] [1.20625V]
[1.21250V] [1.21875V] [1.22500V] [1.23125V] [1.23750V] [1.24375V] [1.25000V]
[1.25625V] [1.26250V] [1.26875V] [1.27500V] [1.28125V] [1.28750V] [1.29375V]
[1.30000V]~[1.87500V] [1.88125V] [1.88750V] [1.89375V] [1.90000V] [1.95000V]
[1.97500V] [2.00000V] [2.05000V] [2.07500V] [2.10000V]~[2.20000V] [2.22500V]
[2.25000V] [2.27500V] [2.30000V]



The configuration options appear when you set **Ai Overclock Tuner** to [Manual].



Refer to the CPU documentation before setting the CPU voltage. Setting a high voltage may damage the CPU permanently, and setting a low voltage may make the system unstable.

CPU PLL Voltage [Auto]

Allows you to select the CPU PLL voltage. The text color in the configuration field corresponds to the onboard CPU LED color, both of which indicate voltage condition. When you set the **CPU LED** item to [PLL Volt], the onboard CPU LED displays CPU PLL voltage condition. Refer to page 2-1 for CPU LED definition. Configuration options: [Auto] [1.50V] [1.52V] [1.54V] [1.56V] [1.58V] [1.60V]~[2.90V] [2.92V] [2.94V] [2.96V] [2.98V] [3.00V]

North Bridge Voltage [Auto]

Allows you to select the northbridge voltage. The text color in the configuration field indicates voltage condition. When you set the **NB LED Selection** item to [NB Volt], the onboard northbridge LED displays northbridge voltage condition. Refer to page 2-2 for northbridge LED definition. Configuration options: [Auto] [1.25V] [1.27V] [1.29V] [1.31V]~[2.43V] [2.45V] [2.47.V] [2.49V] [2.51V]

DRAM Voltage [Auto]

Allows you to select the DRAM voltage. The text color in the configuration field corresponds to the onboard memory LED color, both of which indicate voltage condition. Refer to page 2-2 for memory LED definition. Configuration options: [Auto] [1.80V] [1.82V] [1.84V] [1.86V] [1.88V] [1.90V]~[3.32V] [3.34V] [3.36V] [3.38V] [3.40V]

FSB Termination Voltage [Auto]

Allows you to select the front side bus (FSB) termination voltage. The text color in the configuration field indicates voltage condition. When you set the **NB LED Selection** item to [FSBT Volt], the onboard northbridge LED displays FSB termination voltage condition. Refer to page 2-2 for northbridge LED definition. Configuration options: [Auto] [1.20V] [1.22V] [1.24V] [1.26V] [1.28V] [1.30V]~[1.90V] [1.92V] [1.94V] [1.96V] [1.98V] [2.00V]



Setting a high FSB termination voltage may damage the chipset and CPU.

South Bridge Voltage [Auto]

Allows you to select the southbridge voltage. The text color in the configuration field indicates voltage condition. When you set the **SB LED Selection** item to [SB Volt], the onboard southbridge LED displays southbridge voltage condition. Refer to page 2-2 for southbridge LED definition. Configuration options: [Auto] [1.050V] [1.075V] [1.110V] [1.125V] [1.150V] [1.175V] [1.200V] [1.225V]

Loadline Calibration [Auto]

Configuration options: [Auto] [Disabled] [Enabled]

CPU Voltage Refernece [Auto]

Configuration options: [Auto] [0.63V] [0.61V] [0.59V] [0.57V]

North Bridge Voltage Refernece [Auto]

Configuration options: [Auto] [0.67V] [0.63V] [0.60V] [0.57V] [0.56V] [0.53V] [0.51V] [0.49V]

DDR2 Channel A REF Voltage [Auto]

Allows you to manually set the memory voltage, or you can set to [Auto] for the safe mode.

Configuration options: [DDR2_REF-30mv] [DDR2_REF-20mv] [DDR2_REF-10mv] [DDR2_REF] [DDR2_REF+10mv] [DDR2_REF+20mv] [DDR2_REF+30mv]

DDR2 Channel B REF Voltage [Auto]

Allows you to manually set the memory voltage, or you can set to [Auto] for the safe mode.

Configuration options: [DDR2_REF-30mv] [DDR2_REF-20mv] [DDR2_REF-10mv] [DDR2_REF] [DDR2_REF+10mv] [DDR2_REF+20mv] [DDR2_REF+30mv]

DDR2 Controller REF Voltage [Auto]

Allows you to manually set the memory voltage, or you can set to [Auto] for the safe mode.

Configuration options: [DDR2_REF-30mv] [DDR2_REF-20mv] [DDR2_REF-10mv] [DDR2_REF] [DDR2_REF+10mv] [DDR2_REF+20mv] [DDR2_REF+30mv]

SB 1.5V Voltage [Auto]

Allows you to select the southbridge 1.5V voltage. The text color in the configuration field indicates voltage condition. When you set the **SB LED Selection** item to [SB 1.5 Volt], the onboard southbridge LED displays southbridge 1.5V voltage condition. Refer to page 2-2 for southbridge LED definition.

Configuration options: [Auto] [1.50V] [1.55V] [1.60V] [1.65V] [1.70V] [1.75V] [1.80V] [1.85V] [1.90V] [1.95V] [2.00V] [2.05V]

VCC EXT PLL Over Voltage [Disabled]

Configuration options: [Enabled] [Disabled]

Clock Over-Charging Voltage [Auto]

Configuration options: [0.70V] [0.80V] [0.90V] [1.00V]

NB LED Selection [NB Volt]

Allows you to switch the onboard northbridge LED display between northbridge voltage [NB Volt] and front side bus termination voltage [FSBT Volt].

Configuration options: [NB Volt] [FSBT Volt]

SB LED Selection [SB Volt]

Allows you to switch the onboard southbridge LED display between southbridge voltage [SB Volt] and southbridge 1.5V voltage [SB 1.5 Volt].

Configuration options: [SB 1.5 Volt] [SB Volt]

CPU LED [CPU Volt]

Allows you to switch the onboard CPU LED display between CPU voltage [CPU Volt] and CPU PLL voltage [PLL Volt].

Configuration options: [CPU Volt] [PLL Volt]

DDR LED [Turn on]

Turns on/off the onboard memory LED. Configuration options: [Turn on] [Turn off]

CPU Spread Spectrum [Auto]

Allows you to enable or disable the CPU spread spectrum.

Configuration options: [Auto] [Disabled]

PCIE Spread Spectrum [Auto]

Allows you to enable or disable the PCIE spread spectrum.

Configuration options: [Auto] [Disabled]

4.5 Advanced menu

The Advanced menu items allow you to change the settings for the CPU and other system devices.

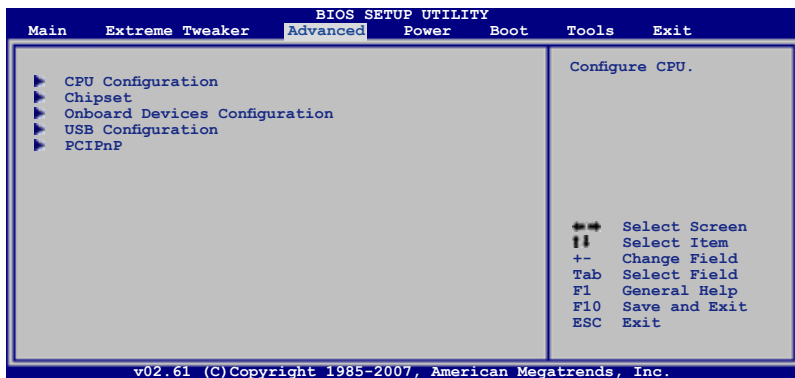

4.5.1 CPU Configuration

The items in this menu show the CPU-related information that the BIOS automatically detects.

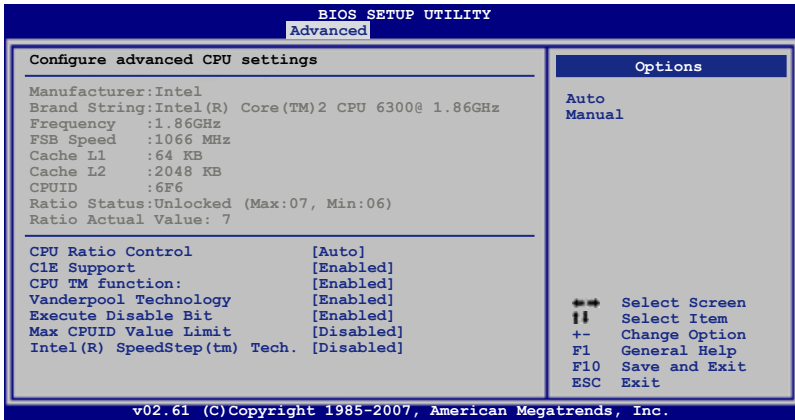

CPU Ratio Control [Auto]

Configuration options: [Auto] [Manual]



The following item appears when the item **CPU Ratio Control** is set to [Manual].

Ratio CMOS Setting [7]

Whether this item is configurable depends on your CPU type. The valid value ranges differently according to your CPU type. If this item is configurable, enter the value using the numeric keypad.

C1E Support [Enabled]

Allows you to enable or disable C1E Support.

Configuration options: [Enabled] [Disabled]

CPU TM function [Enabled]

Configuration options: [Disabled] [Enabled]

Vanderpool Technology [Enabled]

Configuration options: [Enabled] [Disabled]

Execute Disable Bit [Enabled]

Allows you to enable or disable the No-Execution Page Protection Technology. Setting this item to [Disabled] forces the XD feature flag to always return to zero (0). Configuration options: [Disabled] [Enabled]

Max CPUID Value Limit [Disabled]

Setting this item to [Enabled] allows legacy operating systems to boot even without support for CPUs with extended CPUID functions.

Configuration options: [Disabled] [Enabled]

Inter(R) SpeedStep (TM) Tech. [Enabled]

The following item appears when the **CPU Ratio Control** item is set to [Auto].

Configuration options: [Enabled] [Disabled]

4.5.2 Chipset

The Chipset menu allows you to change the advanced chipset settings. Select an item then press <Enter> to display the sub-menu.

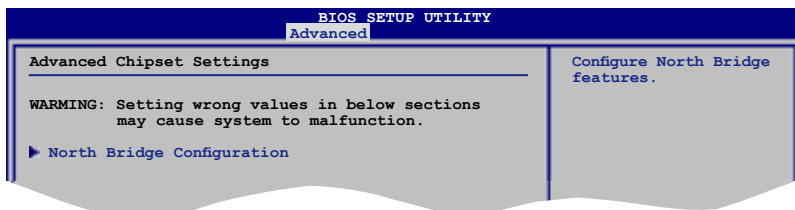

North Bridge Chipset Configuration

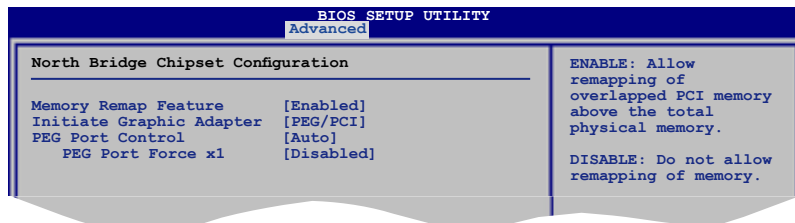

Memory Remap Feature [Enabled]

Allows you to enable or disable the remapping of the overlapped PCI memory above the total physical memory. Enable this option only when you install 64-bit operating system. Configuration options: [Disabled] [Enabled]

Initiate Graphic Adapter [PEG/PCI]

Allows you to decide which graphics controller to use as the primary boot device. Configuration options: [PCI/PEG] [PEG/PCI]

PEG Port Control [Auto]

Configuration options: [Auto] [Disabled]

PEG Force x1 [Disabled]

This item appears when the PEG Port Control item is set to [Auto].

Configuration options: [Enabled] [Disabled]

4.5.3 OnBoard Devices Configuration

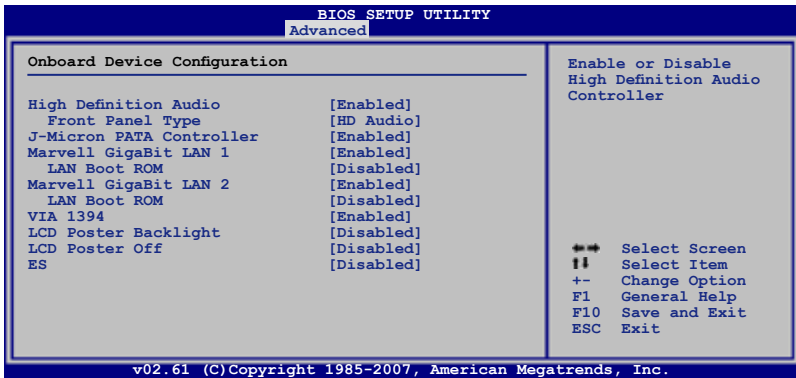

High Definition Audio [Enabled]

Allows you to enable or disable the High Definition Audio. The following item appears only when you enable this item.

Configuration options: [Enabled] [Disabled]

Front Panel Support Type [HD Audio]

Allows you to set the front panel audio connector (AAFP) mode to legacy AC'97 or high-definition audio depending on the audio standard that the front panel audio module supports. Configuration options: [AC97] [HD Audio]

J-Micron PATA Controller [Enabled]

Configuration options: [Enabled] [Disabled]

Marvell GigaBit LAN 1/2 [Enabled]

Configuration options: [Enabled] [Disabled]

LAN Boot ROM [Disabled]

Configuration options: [Disabled] [Enabled]

VIA 1394 [Enabled]

Configuration options: [Enabled] [Disabled]

LCD Poster Backlight [Disabled]

Configuration options: [Enabled] [Disabled]

LCD Poster Off [Disabled]

Configuration options: [Enabled] [Disabled]

ES [Disabled]

Configuration options: [Disabled] [WOL Disabled] [WOL Enabled]

4.5.4 USB Configuration

The items in this menu allows you to change the USB-related features. Select an item then press <Enter> to display the configuration options.

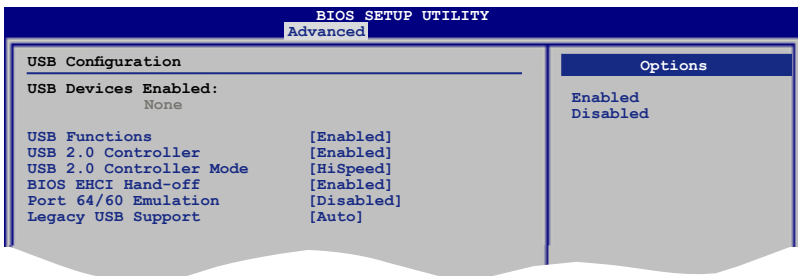

The **USB Devices Enabled** item shows the auto-detected values. If no USB device is detected, the item shows None.

USB Functions [Enabled]

Allows you to enable or disable the USB functions. The following sub-items appear when this item is set to [Enabled]. Configuration options: [Disabled] [Enabled]



The following items appear only when you set **USB Functions** to [Enabled].

USB 2.0 Controller [Enabled]

Allows you to enable or disable the USB 2.0 controller. Configuration options: [Enabled] [Disabled]

USB 2.0 Controller Mode [HiSpeed]

Allows you to set the USB 2.0 controller mode to HiSpeed (480 Mbps) or FullSpeed (12 Mbps). Configuration options: [FullSpeed] [HiSpeed]



The **USB 2.0 Controller Mode** item appears only when you enable the **USB 2.0 Controller**.

BIOS EHCI Hand-off [Enabled]

Allows you to enable the support for operating systems without an EHCI hand-off feature. Configuration options: [Disabled] [Enabled]

Port 64/60 Emulation [Disabled]

Allows you to enable or disable the I/O port 60h/64h emulation support. This item should be enabled for the complete USB keyboard legacy support for non-USB aware OSes. Configuration options: [Disabled] [Enabled]

Legacy USB Support [Auto]

Allows you to enable or disable the support for legacy USB devices. Setting to [Auto] allows the system to detect the presence of USB devices at startup. If detected, the USB controller legacy mode is enabled. If no USB device is detected, the legacy USB support is disabled.

Configuration options: [Disabled] [Enabled] [Auto]

4.5.5 PCI PnP

The PCI/PnP menu items allow you to change the advanced settings for PCI/PnP devices.



Take caution when changing the settings of the PCI PnP menu items. Incorrect field values can cause the system to malfunction.

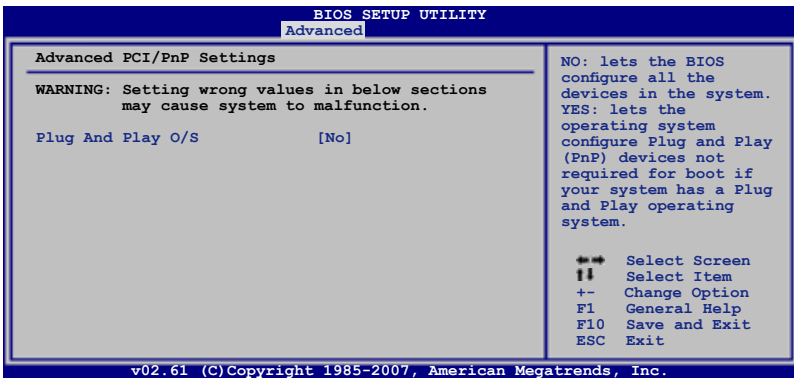

Plug And Play O/S [No]

When set to [No], BIOS configures all the devices in the system. When set to [Yes] and if you install a Plug and Play operating system, the operating system configures the Plug and Play devices not required for boot.

Configuration options: [No] [Yes]

4.6 Power menu

The Power menu items allow you to change the settings for the Advanced Power Management (APM). Select an item then press <Enter> to display the configuration options.

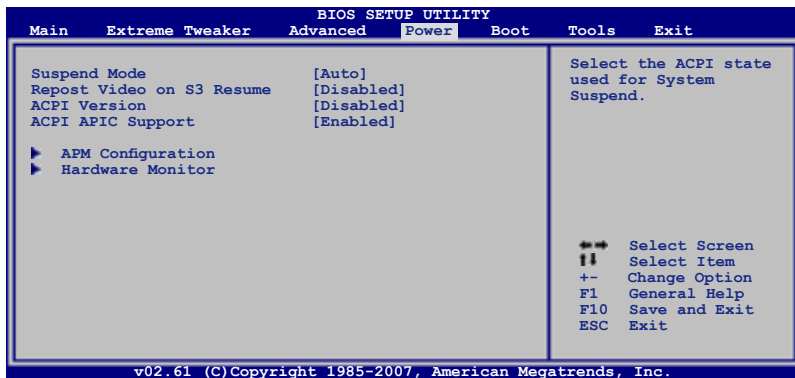

4.6.1 Suspend Mode [Auto]

Allows you to select the Advanced Configuration and Power Interface (ACPI) state to be used for system suspend.

Configuration options: [S1 (POS) Only] [S3 Only] [Auto]

4.6.2 Repost Video on S3 Resume [Disabled]

Determines whether to invoke VGA BIOS POST on S3/STR resume.

Configuration options: [Disabled] [Enabled]

4.6.3 ACPI Version [Disabled]

Specifies the Advanced Configuration and Power Interface (ACPI) version supported. Configuration options: [Disabled] [Enabled]

4.6.4 ACPI APIC Support [Enabled]

Allows you to enable or disable the Advanced Configuration and Power Interface (ACPI) support in the Advanced Programmable Interrupt Controller (APIC). When set to Enabled, the ACPI APIC table pointer is included in the RSDT pointer list.

Configuration options: [Disabled] [Enabled]

4.6.5 APM Configuration

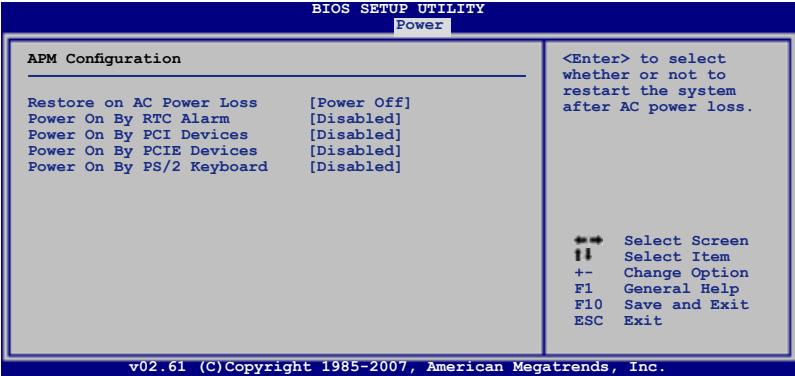

Restore On AC Power Loss [Power Off]

When set to Power Off, the system goes into off state after an AC power loss. When set to Power On, the system goes on after an AC power loss. When set to Last State, the system goes into either off or on state, whatever the system state was before the AC power loss.

Configuration options: [Power Off] [Power On] [Last State]

Power On By RTC Alarm [Disabled]

Allows you to enable or disable RTC to generate a wake event. When this item is set to Enabled, the items RTC Alarm Date/ RTC Alarm Hour/ RTC Alarm Minute/ RTC Alarm Second will become user-configurable with set values.

Configuration options: [Disabled] [Enabled]

Power On By PCI Devices [Disabled]

Allows you to enable or disable the PME to wake up from S5 by PCI devices.

Configuration options: [Disabled] [Enabled]

Power On By PCIE Devices [Disabled]

Allows you to enable or disable the PCIE devices to generate a wake event.

Configuration options: [Disabled] [Enabled]

Power On By PS/2 Keyboard [Disabled]

Allows you to disable the Power On by PS/2 keyboard function or set specific keys on the PS/2 keyboard to turn on the system. This feature requires an ATX power supply that provides at least 1A on the +5VSB lead.

Configuration options: [Disabled] [Space Bar] [Ctrl-Esc] [Power Key]

4.6.6 Hardware Monitor

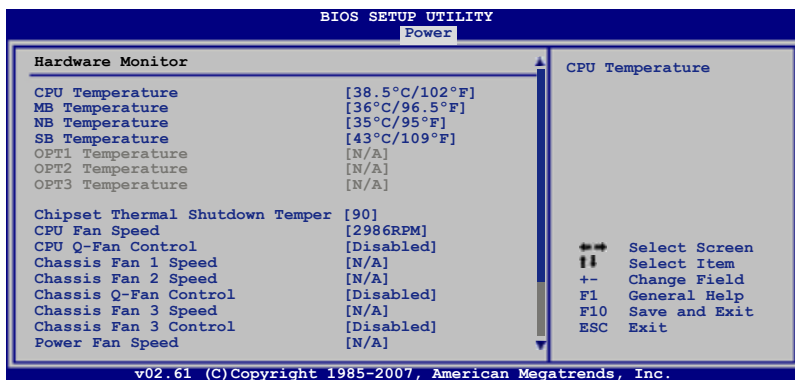

Scroll down to see more items.

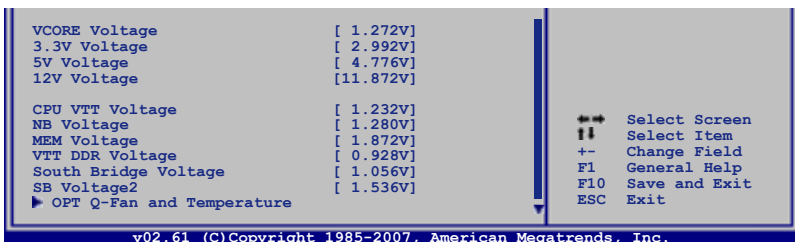

CPU Temperature; MB Temperature; NB Temperature; SB Temperature; OPT1/2/3 Temperature [xxx°C/xxx°F]

The onboard hardware monitor automatically detects and displays the CPU, motherboard, northbridge, southbridge, and the assigned device temperatures. Select [Ignored] if you do not wish to display the detected temperatures.

Chipset Thermal Shutdown Temperature [90]

Configuration options: [Disabled] [70] [80] [90]

CPU Fan Speed [xxxxRPM] or [Ignored] / [N/A]

The onboard hardware monitor automatically detects and displays the CPU fan speed in rotations per minute (RPM). If the fan is not connected to the motherboard, the field shows N/A.

CPU Q-Fan Control [Disabled]

Allows you to enable or disable the CPU Q-Fan controller.

Configuration options: [Disabled] [Enabled]



The **CPU Fan Profile** item appears when you enable the CPU Q-Fan Control feature.

CPU Fan Profile [Optimal]

Allows you to set the appropriate performance level of the CPU Q-Fan. When set to [Optimal], the CPU fan automatically adjusts depending on the CPU temperature. Set this item to [Silent Mode] to minimize fan speed for quiet CPU fan operation, or [Performance Mode] to achieve maximum CPU fan speed. Configuration options: [Optimal] [Silent Mode] [Performance Mode]

Chassis Fan 1/2 Speed [xxxxRPM] or [Ignored] / [N/A]

The onboard hardware monitor automatically detects and displays the chassis fan speed in rotations per minute (RPM). If the fan is not connected to the motherboard, the field shows N/A.

Chassis Q-Fan Controls [Disabled]

Allows you to enable or disable the chassis Q-Fan controller. Configuration options: [Disabled] [Enabled]



The following two items appear when you enable the **Chassis Q-Fan Controls** feature.

Chassis Fan Ratio [Auto]

Configuration options: [Auto] [90%] [80%] [70%] [60%]

Chassis Target Temperature [37°C]

Configuration options: [28°C] [31°C] [34°C] [37°C] [40°C] [43°C] [46°C]

Chassis Fan 3 Speed [xxxxRPM] or [Ignored] / [N/A]

The onboard hardware monitor automatically detects and displays the chassis fan speed in rotations per minute (RPM). If the fan is not connected to the motherboard, the field shows N/A.

Chassis Fan 3 Control [Disabled]

Allows you to enable or disable the chassis Q-Fan controller. Configuration options: [Disabled] [Menu Mode] [Auto]



The following item appears when you set the **Chassis Fan 3 Control** to [Menu Mode].

PWM Mode [50%]

Configuration options: [50%] [60%] [70%] [80%] [90%] [100%]

Power Fan Speed [xxxxRPM] or [Ignored] / [N/A]

The onboard hardware monitor automatically detects and displays the chassis fan speed in rotations per minute (RPM). If the fan is not connected to the motherboard, the field shows N/A.

VCORE Voltage, 3.3V Voltage, 5V Voltage, 12V Voltage, CPU VTT Voltage, NB Voltage, MEM Voltage, VTT DDR Voltage, South Bridge Voltage, SB Voltage2

The onboard hardware monitor automatically detects the voltage output through the onboard voltage regulators.

OPT Q-Fan and Temperature

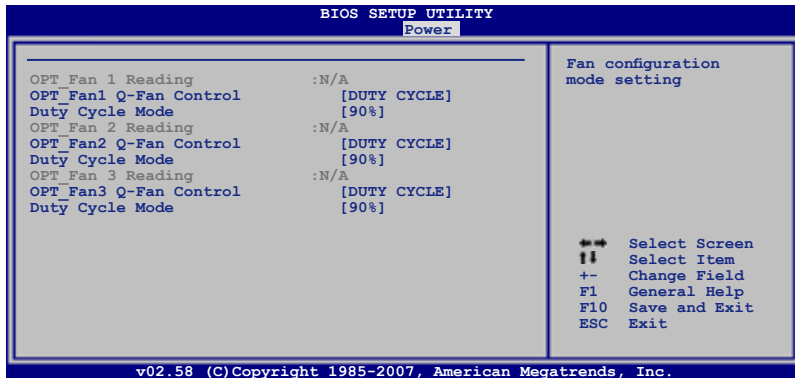

The onboard hardware monitor automatically detects the optional fan speed. If the fan is not connected to the motherboard, the field shows N/A.

OPT_Fan1/2/3 Q-Fan Control [DUTY CYCLE]

Allows you to select the optional fan control mode. When this item is set to [DUTY CYCLE], you can configure the **Duty Cycle Mode** item. If you set this item to [Q-FAN], you are allowed to configure the **TargetTemp Value** item. The Q-Fan detects the temperature of the fan connected to the OPT_FAN1/2/3 connector and adjusts the fan speed.

Configuraiton options: [DUTY CYCLE] [Q-FAN]



You need to connect the thermal sensor cables to the OPT_TEMP1/2/3 connectors to enable this function.

Duty Cycle Mode [90%]

Allows you to set the fan duty cycle. When the **OPT_Fan1/2/3 Q-Fan Control** item is set to [Q-FAN], this item does not appear.

Configuraiton options: [70%] [80%] [90%] [100%]

TargetTemp Value [32]

Allows you to set the temperature at which the optional fan starts up. When the **OPT_Fan1/2/3 Q-Fan Control** item is set to [DUTY CYCLE], this item does not appear. Configuration options: [16] [24] [32] [40] [48] [56] [64] [72]

4.7 Boot menu

The Boot menu items allow you to change the system boot options. Select an item then press <Enter> to display the sub-menu.

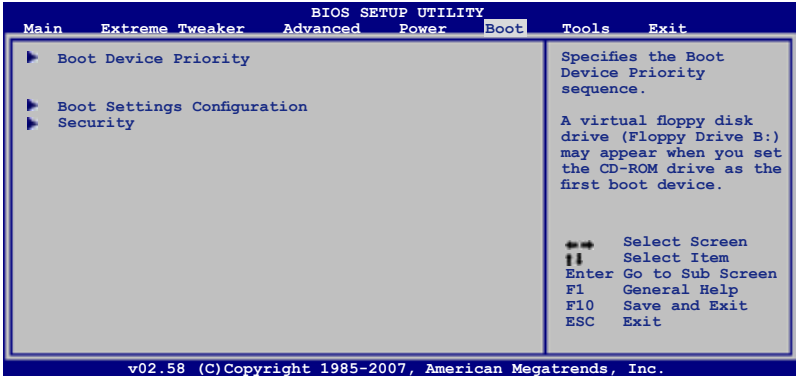

4.7.1 Boot Device Priority

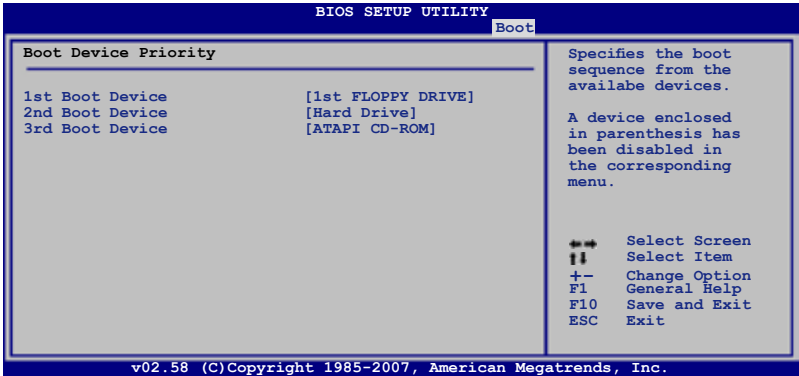

1st ~ xxth Boot Device [xxx Drive]

These items specify the boot device priority sequence from the available devices. The number of device items that appears on the screen depends on the number of devices installed in the system.

Configuration options: [xxx Drive] [Disabled]

4.7.2 Boot Settings Configuration

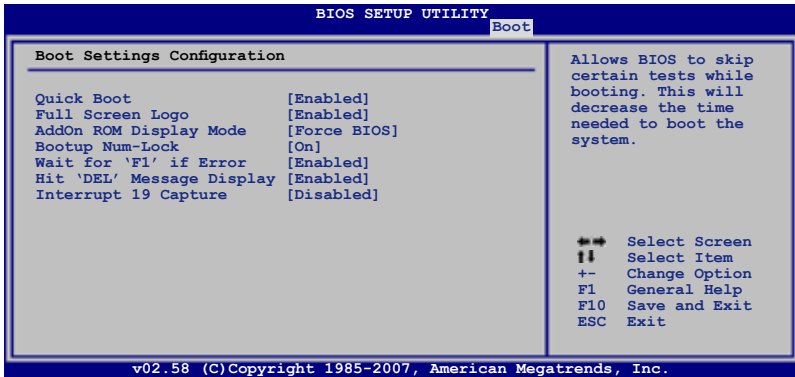

Quick Boot [Enabled]

Enabling this item allows the BIOS to skip some power on self tests (POST) while booting to decrease the time needed to boot the system. When set to [Disabled], BIOS performs all the POST items. Configuration options: [Disabled] [Enabled]

Full Screen Logo [Enabled]

This allows you to enable or disable the full screen logo display feature. Configuration options: [Disabled] [Enabled]



Set this item to [Enabled] to use the ASUS MyLogo 3™ feature.

AddOn ROM Display Mode [Force BIOS]

Sets the display mode for option ROM. Configuration options: [Force BIOS] [Keep Current]

Bootup Num-Lock [On]

Allows you to select the power-on state for the NumLock. Configuration options: [Off] [On]

Wait for 'F1' If Error [Enabled]

When set to Enabled, the system waits for the F1 key to be pressed when error occurs. Configuration options: [Disabled] [Enabled]

Hit 'DEL' Message Display [Enabled]

When set to Enabled, the system displays the message "Press DEL to run Setup" during POST. Configuration options: [Disabled] [Enabled]

Interrupt 19 Capture [Disabled]

When set to [Enabled], this function allows the option ROMs to trap Interrupt 19. Configuration options: [Disabled] [Enabled]

4.7.3 Security

The Security menu items allow you to change the system security settings. Select an item then press <Enter> to display the configuration options.

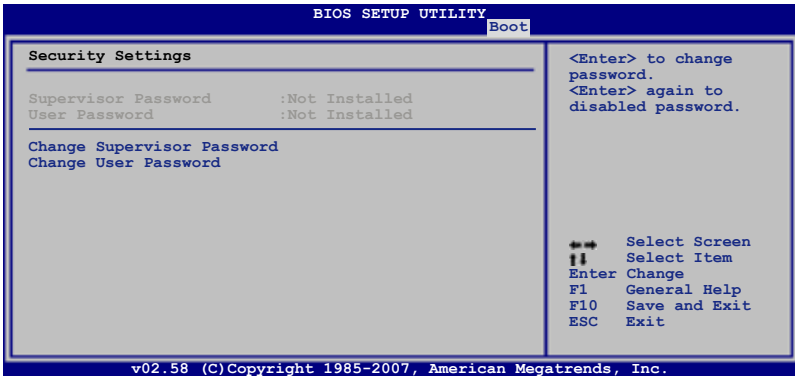

Change Supervisor Password

Select this item to set or change the supervisor password. The Supervisor Password item on top of the screen shows the default Not Installed. After you set a password, this item shows Installed.

To set a Supervisor Password:

1. Select the Change Supervisor Password item and press <Enter>.
2. From the password box, type a password composed of at least six letters and/or numbers, then press <Enter>.
3. Confirm the password when prompted.

The message "Password Installed" appears after you successfully set your password.

To change the supervisor password, follow the same steps as in setting a user password.

To clear the supervisor password, select the Change Supervisor Password then press <Enter>. The message "Password Uninstalled" appears.



If you forget your BIOS password, you can clear it by erasing the CMOS Real Time Clock (RTC) RAM. See section 2.6 Switch for information on how to erase the RTC RAM.

After you have set a supervisor password, the other items appear to allow you to change other security settings.



User Access Level [Full Access]

This item allows you to select the access restriction to the Setup items.

Configuration options: [No Access] [View Only] [Limited] [Full Access]

[No Access] prevents user access to the Setup utility.

[View Only] allows access but does not allow change to any field.

[Limited] allows changes only to selected fields, such as Date and Time.

[Full Access] allows viewing and changing all the fields in the Setup utility.

Change User Password

Select this item to set or change the user password. The User Password item on top of the screen shows the default Not Installed. After you set a password, this item shows Installed.

To set a User Password:

1. Select the Change User Password item and press <Enter>.
2. On the password box that appears, type a password composed of at least six letters and/or numbers, then press <Enter>.
3. Confirm the password when prompted.

The message "Password Installed" appears after you set your password successfully.

To change the user password, follow the same steps as in setting a user password.

Clear User Password

Select this item to clear the user password.

Password Check [Setup]

When set to [Setup], BIOS checks for user password when accessing the Setup utility. When set to [Always], BIOS checks for user password both when accessing Setup and booting the system. Configuration options: [Setup] [Always]

4.8 Tools menu

The Tools menu items allow you to configure options for special functions. Select an item then press <Enter> to display the sub-menu.

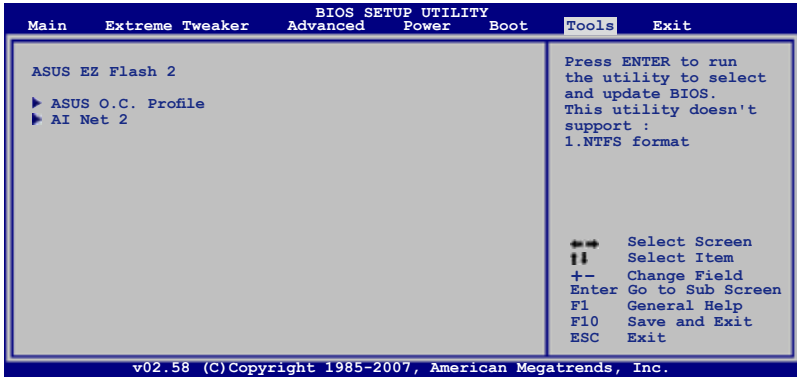

4.8.1 ASUS EZ Flash 2

Allows you to run ASUS EZ Flash 2. When you press <Enter>, a confirmation message appears. Use the left/right arrow key to select between [Yes] or [No], then press <Enter> to confirm your choice. Please see page 4-5, section 4.1.3 for details.

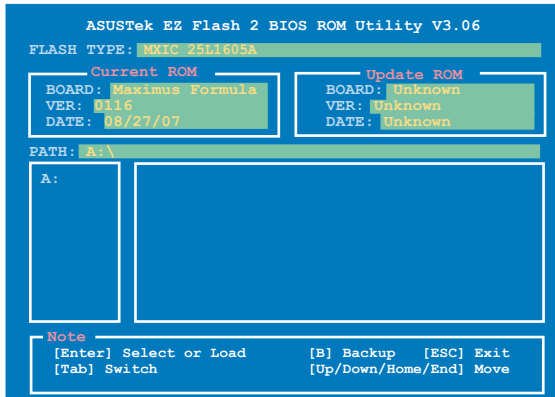

4.8.2 ASUS O.C. Profile

This item allows you to store or load multiple BIOS settings.



Save to Profile 1/2

Allows you to save the current BIOS file to the BIOS Flash. Press <Enter> to save the file.

Load from Profile 1/2

Allows you to load the previous BIOS settings saved in the BIOS Flash. Press <Enter> to load the file.

Start O.C. Profile

Allows you to run the utility to save and load CMOS. Press <Enter> to run the utility.

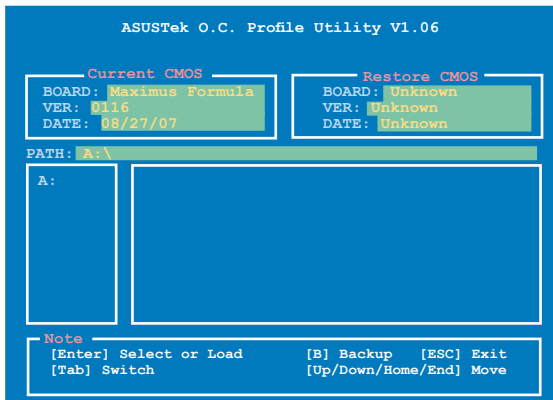

- This function can support devices such as USB flash disk or floppy disk with FAT 32/16 format and single partition only.
- DO NOT shut down or reset the system while updating the BIOS to prevent the system boot failure!

4.8.3 AI Net 2

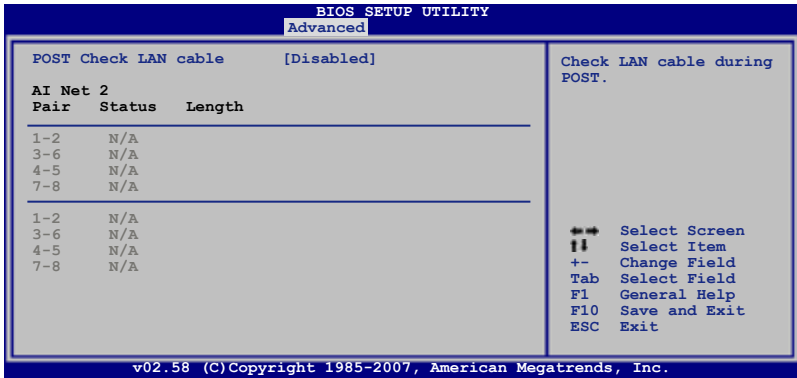

POST Check LAN Cable [Disabled]

Enables or disables checking of the LAN cable during the Power-On Self-Test (POST). Configuration options: [Disabled] [Enabled]

4.9 Exit menu

The Exit menu items allow you to load the optimal or failsafe default values for the BIOS items, and save or discard your changes to the BIOS items.

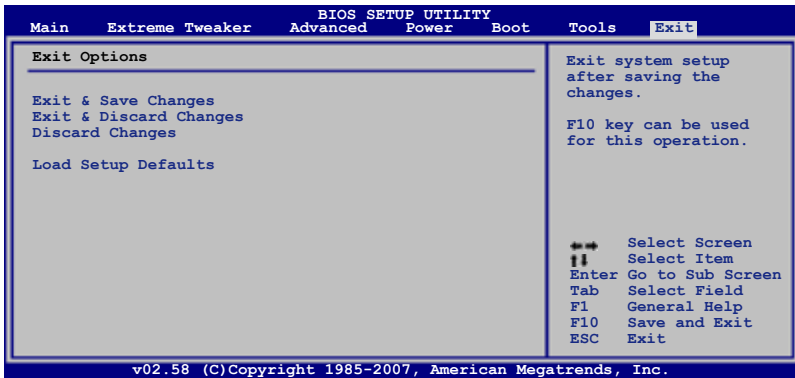

Pressing <Esc> does not immediately exit this menu. Select one of the options from this menu or <F10> from the legend bar to exit.

Exit & Save Changes

Once you are finished making your selections, choose this option from the Exit menu to ensure the values you selected are saved to the CMOS RAM. An onboard backup battery sustains the CMOS RAM so it stays on even when the PC is turned off. When you select this option, a confirmation window appears. Select YES to save changes and exit.



If you attempt to exit the Setup program without saving your changes, the program prompts you with a message asking if you want to save your changes before exiting. Press <Enter> to save the changes while exiting.

Exit & Discard Changes

Select this option only if you do not want to save the changes that you made to the Setup program. If you made changes to fields other than System Date, System Time, and Password, the BIOS asks for a confirmation before exiting.

Discard Changes

This option allows you to discard the selections you made and restore the previously saved values. After selecting this option, a confirmation appears. Select YES to discard any changes and load the previously saved values.

Load Setup Defaults

This option allows you to load the default values for each of the parameters on the Setup menus. When you select this option or if you press <F5>, a confirmation window appears. Select YES to load default values. Select Exit & Save Changes or make other changes before saving the values to the non-volatile RAM.

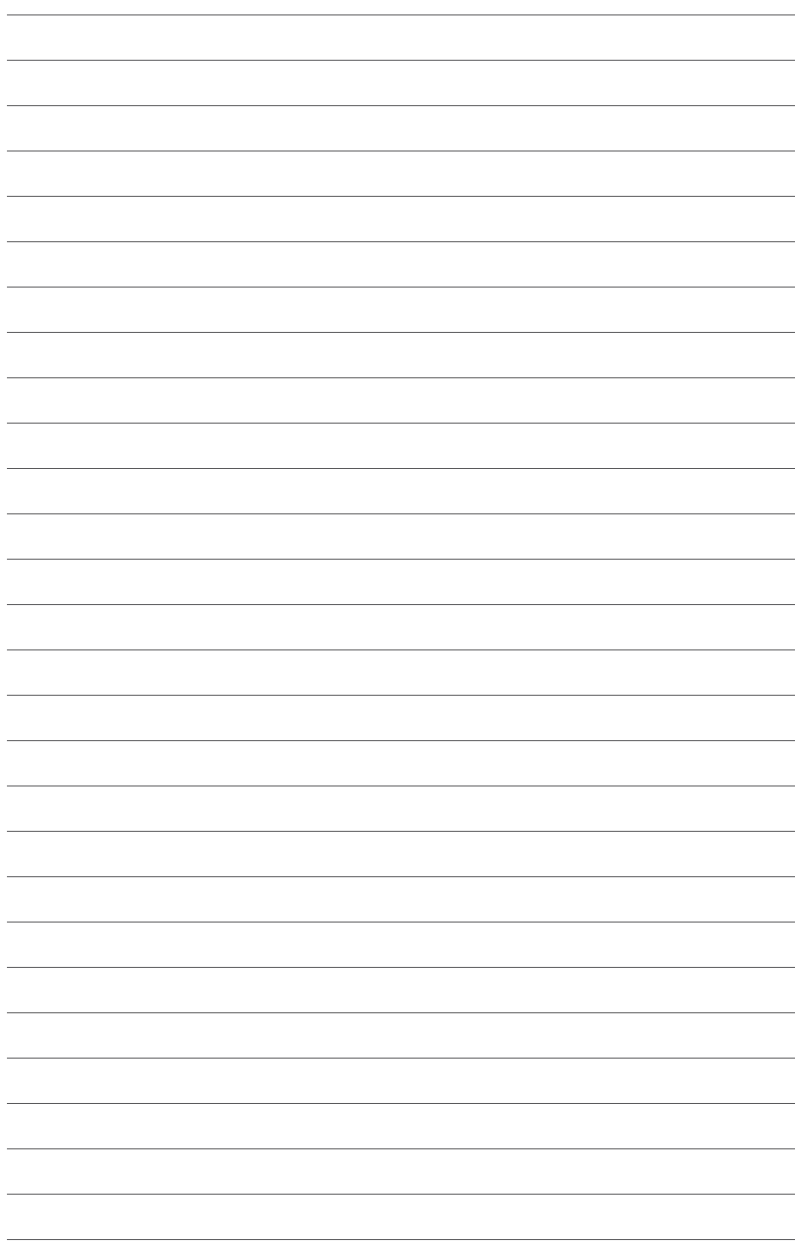

This chapter describes the contents of the support DVD that comes with the motherboard package.

5 Software support

5.1	Installing an operating system	5-1
5.2	Support DVD information	5-1
5.3	Software information	5-9
5.4	RAID configurations	5-33
5.5	Creating a RAID driver disk.....	5-42

5.1 Installing an operating system

This motherboard supports Windows® XP/64-bit XP/Vista/64-bit Vista operating systems (OS). Always install the latest OS version and corresponding updates to maximize the features of your hardware.



- Motherboard settings and hardware options vary. Use the setup procedures presented in this chapter for reference only. Refer to your OS documentation for detailed information.
- Make sure that you install Windows® 2000 Service Pack 4 or the Windows® XP Service Pack2 or later versions before installing the drivers for better compatibility and system stability.

5.2 Support DVD information

The support DVD that came with the motherboard package contains the drivers, software applications, and utilities that you can install to avail all motherboard features.



The contents of the support DVD are subject to change at any time without notice. Visit the ASUS website (www.asus.com) for updates.

5.2.1 Running the support DVD

Place the support DVD to the optical drive. The DVD automatically displays the Drivers menu if Autorun is enabled in your computer.



Click an icon to display support DVD/motherboard information

Click an item to install



If Autorun is NOT enabled in your computer, browse the contents of the support DVD to locate the file ASSETUP.EXE from the BIN folder. Double-click the ASSETUP.EXE to run the DVD.

5.2.2 Drivers menu

The drivers menu shows the available device drivers if the system detects installed devices. Install the necessary drivers to activate the devices.



ASUS InstAll - Installation Wizard for Drivers

Launches the ASUS InstAll driver installation wizard.

Intel Chipset Inf Update Program

Installs the Intel® chipset inf update program.

SoundMAX ADI Audio Driver

Installs the SoundMAX® ADI1988 audio driver and application.

Marvell Yukon Gigabit Ethernet Driver

Installs the Marvell Yukon Gigabit Ethernet Driver.

USB 2.0 Driver

Installs the Universal Serial Bus 2.0 (USB 2.0) driver.

5.2.3 Utilities menu

The Utilities menu shows the applications and other software that the motherboard supports.



Click to display the next screen



Click to display the previous screen

ASUS InstAll-Installation Wizard for Utilities

Installs all of the utilities through the Installation Wizard.

Marvell Yukon VCT Application

Installs the Marvell Yukon VCT applications.

Marvell Yukon CPA Application

Installs the Marvell Yukon CPA applications.

ASUS PC Probe II

This smart utility monitors the fan speed, CPU temperature, and system voltages, and alerts you of any detected problems. This utility helps you keep your computer in healthy operating condition.

ASUS AI Suite

Installs the ASUS AI Suite.

ASUS Update

The ASUS Update utility allows you to update the motherboard BIOS in Windows® environment. This utility requires an Internet connection either through a network or an Internet Service Provider (ISP).

Adobe Acrobat Reader V7.0

Installs the Adobe® Acrobat® Reader that allows you to open, view, and print documents in Portable Document Format (PDF).

Microsoft DirectX 9.0c

Installs the Microsoft® DirectX 9.0c driver. The Microsoft DirectX® 9.0c is a multimedia technology that enhances computer graphics and sound. DirectX® improves the multimedia features of your computer so you can enjoy watching TV and movies, capturing videos, or playing games in your computer. Visit the Microsoft website (www.microsoft.com) for updates.

Anti-Virus Utility

The anti-virus application scans, identifies, and removes computer viruses. View the online help for detailed information.

3DMark06 Software

Installs the 3Dmark06 software.

WinDVD Copy5 Trial

Installs the WinDVD Copy5 Trial version.

InterVideo MediaOne Gallery

Installs the InterVideo Media One Gallery software.

Ulead PhotoImpact 12 SE

Installs the Ulead PhotoImpact 12 SE software.

CyberLink PowerBackup

Installs the CyberLink Powerbackup software.

Corel Snapfire Plus SE

Installs the Corel Snapfire Plus SE software.

5.2.4 Make Disk menu

The Make Disk menu contains items to create the Intel ICH9R or JMicron® JMB368 RAID/AHCI driver disk.



Intel ICH9 32/64 bit RAID/AHCI Driver

Allows you to create an ICH9R 32/64bit RAID/AHCI driver disk.

JMicron JMB36X 32/64 bit RAID/AHCI Driver

Allows you to create a JMicron JMB368 32/64bit RAID/AHCI driver disk.

5.2.5 Manuals menu

The Manuals menu contains a list of supplementary user manuals. Click an item to open the folder of the user manual.



Most user manual files are in Portable Document Format (PDF). Install the Adobe® Acrobat® Reader from the Utilities menu before opening a user manual file.



5.2.6 Video menu

Click the Video tab to display a list of video clips. Click the Extreme OC Clip item to watch how an overclocking guru breaks 3DMark world record with an ROG motherboard.



5.2.7 ASUS Contact information

Click the Contact tab to display the ASUS contact information. You can also find this information on the inside front cover of this user guide.



5.2.8 Other information

The icons on the top right corner of the screen give additional information on the motherboard and the contents of the support DVD. Click an icon to display the specified information.

Motherboard Info

Displays the general specifications of the motherboard.

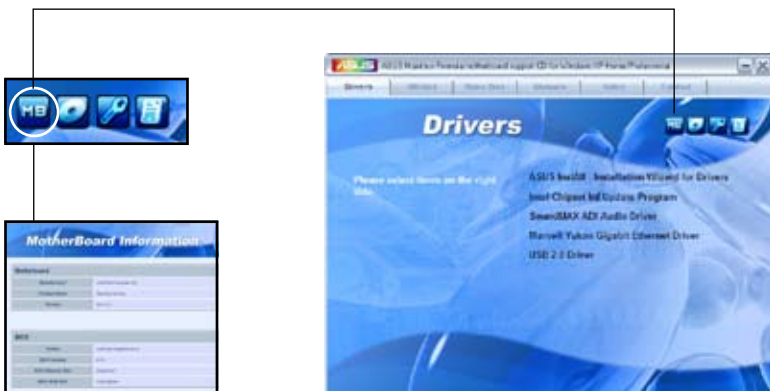

Browse this DVD

Displays the support DVD contents in graphical format.

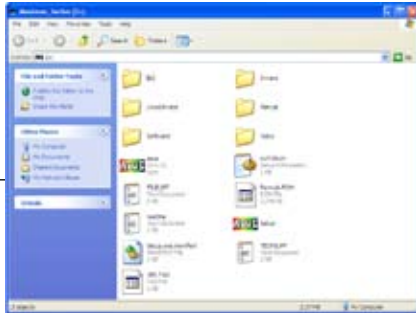

Technical support form

Displays the ASUS Technical Support Request Form that you have to fill out when requesting technical support.

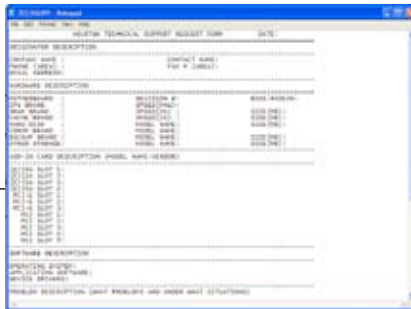

Filelist

Displays the contents of the support DVD and a brief description of each in text format.



- When the logo images appear on the right window pane, select an image to enlarge by clicking on it.

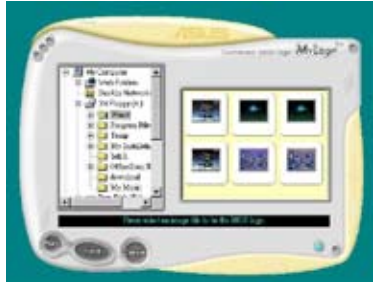

- Adjust the boot image to your desired size by selecting a value on the Ratio box.



- When the screen returns to the ASUS Update utility, flash the original BIOS to load the new boot logo.
- After flashing the BIOS, restart the computer to display the new boot logo during POST.

5.3.2 AI NET 2

The AI NET 2 features the Marvell® Virtual Cable Tester™ (VCT). VCT is a cable diagnostic utility that reports LAN cable faults and shorts using the Time Domain Reflectometry (TDR) technology. The VCT detects and reports open and shorted cables, impedance mismatches, pair swaps, pair polarity problems, and pair skew problems of up to 64 ns at one meter accuracy.

The VCT feature reduces networking and support costs through a highly manageable and controlled network system. This utility can be incorporated in the network systems software for ideal field support as well as development diagnostics.

Using the Virtual Cable Tester™

To use the the Marvell® Virtual Cable Tester™ utility:

1. Launch the VCT utility from the Windows® desktop by clicking **Start > All Programs > Marvell > Virtual Cable Tester**.
2. Click **Virtual Cable Tester** from the menu to display the screen below.

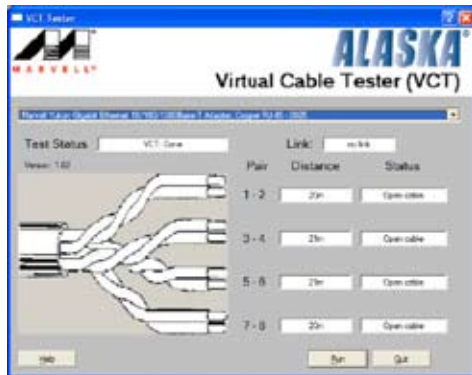

3. Click the **Run** button to perform a cable test.



- The VCT only runs on systems with Windows® XP or Windows® Vista™ operating systems.
- The VCT utility only tests Ethernet cables connected to Gigabit LAN port(s).
- The Run button on the Virtual Cable Tester™ main window is disabled if no problem is detected on the LAN cable(s) connected to the LAN port(s).
- If you want the system to check the status of the LAN cable before entering the OS, enable the item Post Check LAN Cable in the BIOS Setup.

5.3.3 AI Audio 2 (SoundMAX® High Definition Audio utility)

The ADI AD1988 High Definition Audio CODEC provides 8-channel audio capability through the SoundMAX® audio utility with AudioESP™ software to deliver the ultimate audio experience on your PC. The software implements high quality audio synthesis/rendering, 3D sound positioning, and advanced voice-input technologies.

Follow the installation wizard to install the ADI AD1988 Audio Driver from the support DVD that comes with the motherboard package to activate the SoundMAX® audio utility.



You must use 4-channel, 6-channel or 8-channel speakers for this setup.

If the SoundMAX® audio utility is correctly installed, you will find the SoundMAX®/ SoundMAX® BlackHawk icon on the taskbar.



A. SoundMAX BlackHawk (AI Audio 2)

If you are using Windows Vista™ operating system, from the taskbar, double-click on the SoundMAX® BlackHawk icon to display the SoundMAX® control panel.



Enabling AI Audio 2

Click the power button  to activate digital signal processing. AI Audio 2, with the new SoundMAX® BlackHawk by Sonic Focus, brings you more multi-media enjoyment.

Fidelity Compensation

After you click the power button, the utility will compensate for the fidelity lost in the compression process and make the audio output quasi-original when reverting the compressed audio streams back to the uncompressed condition.

Sound Field Expansion

AI Audio 2 also expands the stereophonic sound field to a multi-channel one with realistic front and rear environment.

Surround Virtualization

Activating this function virtualizes surround sound with the vocal clarity added for use with stereo speakers or headphones.



SoundMAX BlackHawk (AI Audio2) is available only under the Windows® Vista™ operating system.

Playback Settings

To configure the playback settings, click the **Playback** button on the control panel. You can adjust the volume of the **Speakers** and **SPDIF Interface** or mute the audio.

Preset settings

Click and expand the drop-down menu to select your preferred Digital Signal Processing (DSP) preset. Move the sliders to customize the values of **Voice Clarity**, **Dynamics**, **Brilliance**, and **Deep Bass** of each preset. Click Save to save the changes to the current preset. Or, click **Reset** to discard the changes and restore the preset to the factory defaults.



Surround settings

Allows you to change the settings of the stereo speakers. Move the sliders to change the listener position or adjust the center channel volume. Press the **Test Speakers** button to perform speaker test.



Port settings

Click this port settings tab to display the rear panel ports configuration for the speakers or rear panel digital port configuration for the SPDIF interface.



Recording Settings

To change the recording settings, click the **Recording** button on the control panel. You can adjust the speaker delay of **Microphone** or **Line In** by moving the slider rightward or leftward.

Record testing

Click the tab to perform test recording and play the test sample through the speakers or the SPDIF interface.

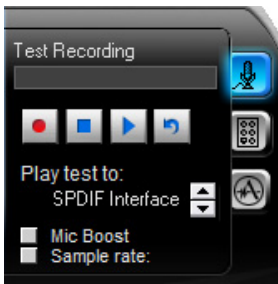

Port settings

Click the tab to display the rear panel ports for Microphone or Line In.



ANDREA settings

Allows you to select an enhanced microphone input features, including **No Filtering**, **Speakerphone**, **Voice Recording**, and **Directional Beam**.

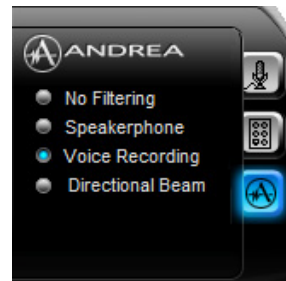

More Settings

Click  for the further configurations.

Equalizer

Allows you to configure and customize all the DSP presets frequencies.



Speakers

Allows you to adjust the **Speaker Trim** and **Speaker Delay**.



Bass

Allows you to do the Bass management.



Preferences

Displays the preference options for this utility, version information, AudioESP, etc.



B. SoundMAX

If you are using Windows XP operating system, from the taskbar, double-click on the SoundMAX® icon to display the SoundMAX® Control Panel.



Audio Setup Wizard

By clicking the  icon from the SoundMAX® control panel, you can easily configure your audio settings. Simply follow the succeeding screen instructions and begin enjoying High Definition Audio.



Jack configuration

This screen helps you configure your computer's audio ports, depending on the audio devices you have installed.



Adjust speaker volume

This screen helps you adjust speaker volume. Click the **Test** button to hear the changes you have made.



Adjust microphone volume

This screen helps you adjust microphone volume. You will be asked to read pre-written text to allow the AudioWizard to adjust the volume as you speak.



Audio preferences

Click the  icon to go to the Preferences page. This page allows you to change various audio settings.

General options

Click the General tab to choose your playback and recording devices, enable/disable the AudioESP™ feature, and enable/disable digital output.

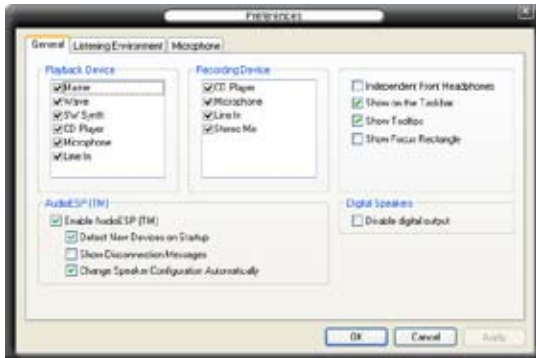

Listening Environment options

Click the Listening Environment tab to set up your speaker, acoustic environment, and enable/disable the Virtual Theater Surround function.

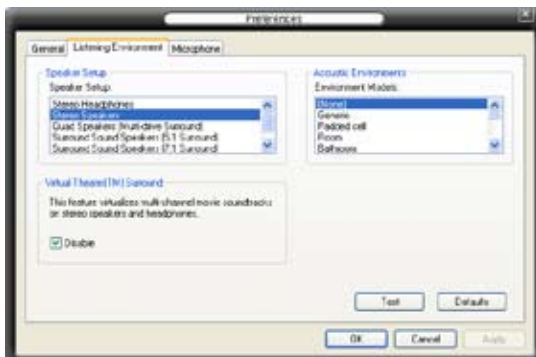

Microphone options

Click the Microphone tab allows you to optimize your microphone input settings.



5.3.4 ASUS PC Probe II

PC Probe II is a utility that monitors the computer's vital components, and detects and alerts you of any problem with these components. PC Probe II senses fan rotations, CPU temperature, and system voltages, among others. Because PC Probe II is software-based, you can start monitoring your computer the moment you turn it on. With this utility, you are assured that your computer is always at a healthy operating condition.

Installing PC Probe II

To install PC Probe II on your computer:

1. Place the support DVD to the optical drive. The Drivers installation tab appears if your computer has an enabled Autorun feature.



If Autorun is not enabled in your computer, browse the contents of the support DVD to locate the setup.exe file from the ASUS PC Probe II folder. Double-click the **setup.exe** file to start installation.

2. Click the **Utilities** tab, then click **ASUS PC Probe II**.
3. Follow the screen instructions to complete installation.

Launching PC Probe II

You can launch the PC Probe II right after installation or anytime from the Windows® desktop.

To launch the PC Probe II from the Windows® desktop, click **Start > All Programs > ASUS > PC Probe II > PC Probe II v1.xx.xx**. The PC Probe II main window appears.

After launching the application, the PC Probe II icon appears in the Windows® taskbar. Click this icon to close or restore the application.









Using PC Probe II

Main window

The PC Probe II main window allows you to view the current status of your system and change the utility configuration. By default, the main window displays the Preference section. You can close or restore the Preference section by clicking on the triangle on the main window right handle.



Click to close the Preference panel

Button	Function
	Opens the Configuration window
	Opens the Report window
	Opens the Desktop Management Interface window
	Opens the Peripheral Component Interconnect window
	Opens the Windows Management Instrumentation window
	Opens the hard disk drive, memory, CPU usage window
	Shows/Hides the Preference section
	Minimizes the application
	Closes the application

Sensor alert

When a system sensor detects a problem, the main window right handle turns red, as the illustrations below show.



When displayed, the monitor panel for that sensor also turns red. Refer to the Monitor panels section for details.

Preferences

You can customize the application using the Preference section in the main window. Click the box before each preference to activate or deactivate.

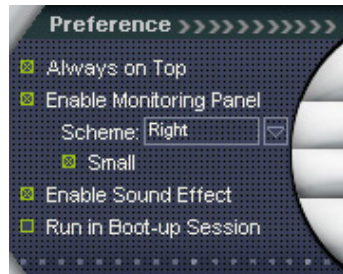

Hardware monitor panels

The hardware monitor panels display the current value of a system sensor such as fan rotation, CPU temperature, and voltages.

The hardware monitor panels come in two display modes: hexagonal (large) and rectangular (small). When you check the Enable Monitoring Panel option from the Preference section, the monitor panels appear on your computer's desktop.



Large display



Small display

Changing the monitor panels position

To change the position of the monitor panels in the desktop, click the arrow down button of the Scheme options, then select another position from the list box. Click OK when finished.





Moving the monitor panels

All monitor panels move together using a magnetic effect. If you want to detach a monitor panel from the group, click the horseshoe magnet icon. You can now move or reposition the panel independently.



Adjusting the sensor threshold value

You can adjust the sensor threshold value in the monitor panel by clicking the  or  buttons. You can also adjust the threshold values using the Config window.

You cannot adjust the sensor threshold values in a small monitoring panel.

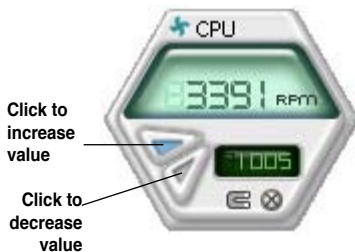

Monitoring sensor alert

The monitor panel turns red when a component value exceeds or is lower than the threshold value. Refer to the illustrations below.



Large display



Small display

WMI browser

Click **WMI** to display the WMI (Windows Management Instrumentation) browser. This browser displays various Windows® management information. Click an item from the left panel to display on the right panel. Click the plus sign (+) before WMI Information to display the available information.



You can enlarge or reduce the browser size by dragging the bottom right corner of the browser.

DMI browser

Click **DMI** to display the DMI (Desktop Management Interface) browser. This browser displays various desktop and system information. Click the plus sign (+) before DMI Information to display the available information.



PCI browser

Click **PCI** to display the PCI (Peripheral Component Interconnect) browser. This browser provides information on the PCI devices installed on your system. Click the plus sign (+) before the PCI Information item to display available information.



Usage

The Usage browser displays real-time information on the CPU, hard disk drive space, and memory usage. Click **USAGE** to display the Usage browser.

CPU usage

The CPU tab displays real-time CPU usage in line graph representation. If the CPU has an enabled Hyper-Threading, two separate line graphs display the operation of the two logical processors.

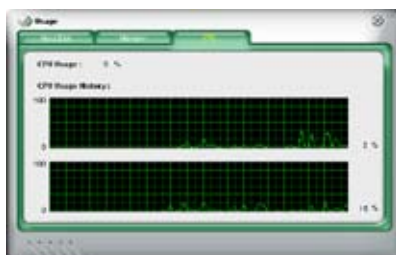

Hard disk drive space usage

The Hard Disk tab displays the used and available hard disk drive space. The left panel of the tab lists all logical drives. Click a hard disk drive to display the information on the right panel. The pie chart at the bottom of the window represents the used (blue) and the available HDD



Memory usage

The Memory tab shows both used and available physical memory. The pie chart at the bottom of the window represents the used (blue) and the available physical memory.



Configuring PC Probe II

Click  to view and adjust the sensor threshold values.

The Config window has two tabs: Sensor/Threshold and Preference. The Sensor/Threshold tab enables you to activate the sensors or to adjust the sensor threshold values. The Preference tab allows you to customize sensor alerts, or change the temperature scale.

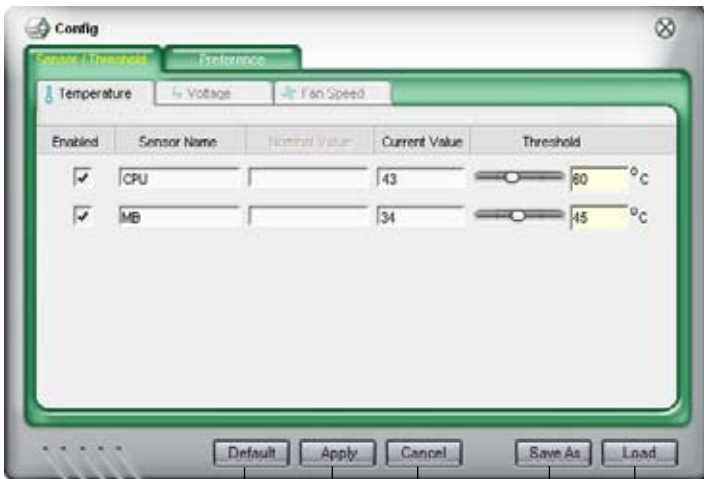

Loads the default threshold values for each sensor

Applies your changes

Cancels or ignores your changes

Loads your saved configuration
Saves your configuration

5.3.5 ASUS AI Suite

ASUS AI Suite allows you to launch AI Gear 3, AI Booster, AI Nap, and Q-Fan 2 utilities easily.



Install the **ASUS EPU + AI Gear 3 Driver** before the ASUS AI Suite utility. Otherwise, ASUS AI Suite will not function properly.

Installing AI Suite

To install AI Suite on your computer:

1. Place the support DVD to the optical drive. The Drivers installation tab appears if your computer has an enabled Autorun feature.
2. Click the Utilities tab, then click **AI Suite**.
3. Follow the screen instructions to complete installation.

Launching AI Suite

You can launch AI Suite right after installation or anytime from the Windows® desktop.

To launch AI Suite from the Windows® desktop, click **Start > All Programs > ASUS > AI Suite > AI Suite v1.xx.xx**. The AI Suite main window appears.

After launching the application, the AI Suite icon appears in the Windows® taskbar. Click this icon to close or restore the application.

Using AI Suite

Click the AI Gear 3, AI Nap, AI Booster, or Q-Fan 2 icon to launch the utility, or click the Normal icon to restore the system to normal state.

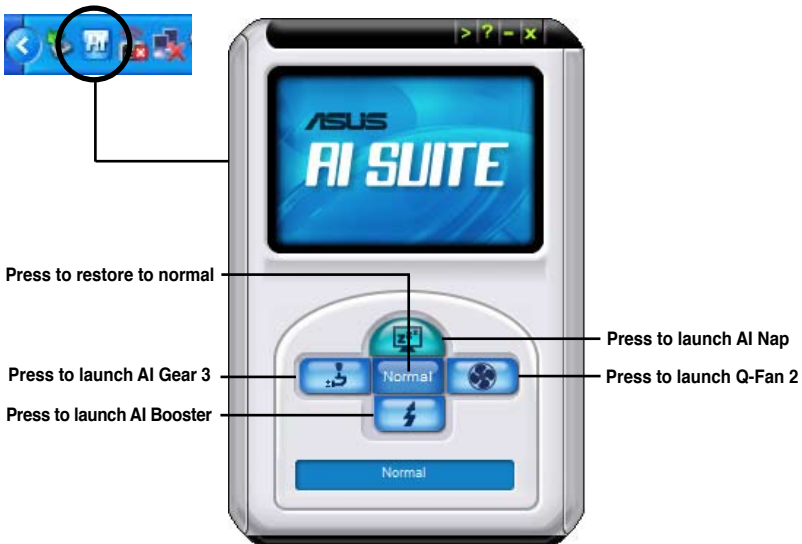

Other feature buttons

Click  on right corner of the main window to open the monitor window.

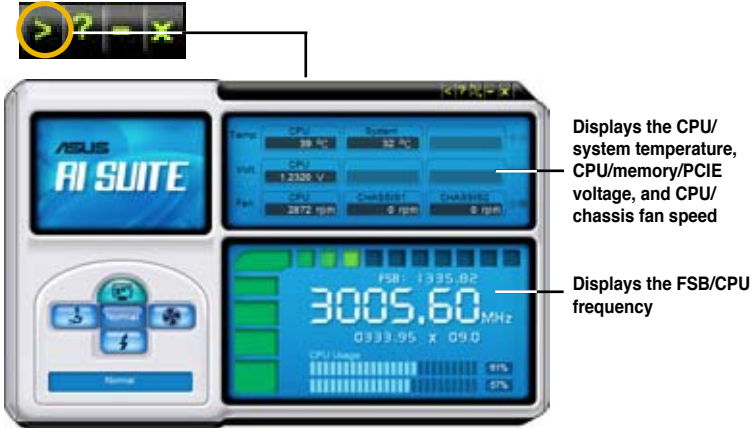

Click  on right corner of the expanded window to switch the temperature from degrees Centigrade to degrees Fahrenheit.



5.3.6 ASUS EPU Utility—AI Gear 3

ASUS AI Gear 3 is a utility designed to configure and support all ASUS Energy Processing Unit (EPU) features. This easy-to-use utility provides four system performance profiles that adjust the processor frequency and vCore voltage for different computing needs.

After installing ASUS AI Suite from the bundled support DVD, you can launch ASUS AI Gear 3 by double-clicking the AI Suite icon on your Windows OS taskbar and then click the AI Gear 3 button on the AI Suite main window.

Here are some simple ways to use AI Gear 3:

- Click the four gear mode buttons below, including **Turbo**, **High Performance**, **Medium Power Saving**, and **Max. Power Saving**, or shift the gear to the performance setting that you like.
- Click **Calibration** first, and switch to **Auto** mode to have AI Gear 3 automatically adjust the system performance according to the CPU loading.
- Under **Auto** mode, Click **Settings** to set the time for the system to enter AI Nap mode.

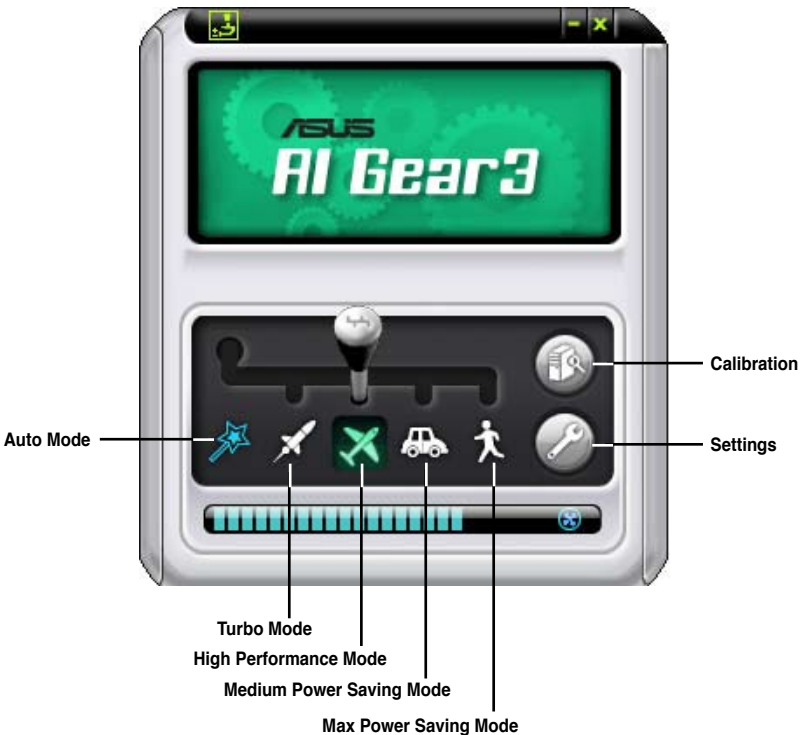

5.3.7 ASUS AI Nap

This feature allows you to minimize the power consumption of your computer whenever you are away. Enable this feature for minimum power consumption and a quieter system operation.

After installing AI Suite from the bundled Support DVD, you can launch the utility by double-clicking the AI Suite icon on the Windows OS taskbar and click the AI Nap button on the AI Suite main window.

Click **Yes** on the confirmation screen.

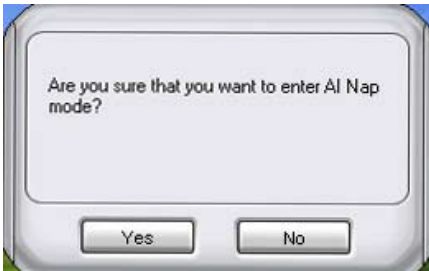

To exit AI Nap mode, press the system power or mouse button then click **Yes** on the confirmation screen.

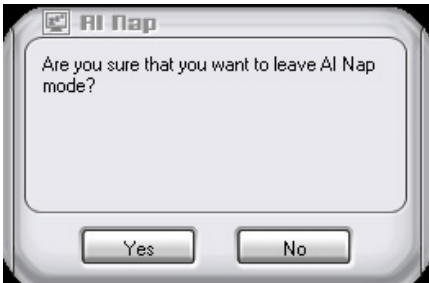

To switch the power button functions from AI Nap to shutting down, just right click the **AI Suite** icon on the OS taskbar, select **AI Nap** and click **Use power button**. Unclick the the item to switch the function back.

5.3.8 ASUS Q-Fan 2

This ASUS Q-Fan 2 Control feature allows you to set the appropriate performance level of the CPU Q-Fan 2 or the Chassis Q-Fan 2 for more efficient system operation. After enabling the Q-Fan 2 function, the fans can be set to automatically adjust depending on the temperature, to decrease fan speed, or to achieve the maximum fan speed.

After installing AI Suite from the bundled Support DVD, you can launch the utility by double-clicking the AI Suite icon on the Windows® OS taskbar and click the Q-Fan 2 button on the AI Suite mAIIn window.

Click the drop-down menu button and display the fan names. Select **CPU Q-Fan** or **CHASSIS Q-Fan**. Click the **Enabled** box to activate this function.



Profile list appears after clicking the **Enabled** box. Click the drop-down list button and select a profile. **Optimal** mode makes the fans adjust speed with the temperature; **Silent** mode minimizes fan speed for quiet fan operation; **Performance** mode boosts the fan to achieve maximal fan speed for the best cooling effect.

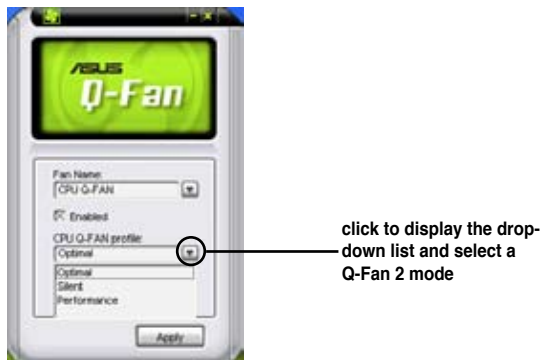

Click **Apply** at the bottom to save the setup.

5.3.9 ASUS AI Booster

The ASUS AI Booster application allows you to overclock the CPU speed in Windows® environment without the hassle of booting the BIOS.

After installing AI Suite from the bundled Support DVD, you can launch the utility by double-clicking the AI Suite icon on the Windows® OS taskbar and click the AI Booster button on the AI Suite main window.

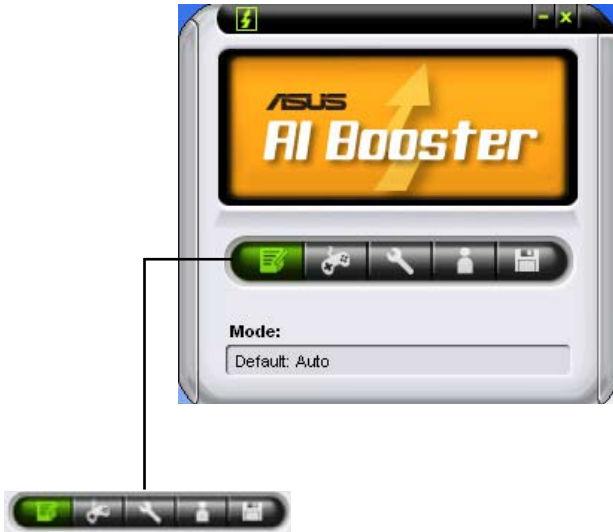

The options on the taskbar allow you to use the default settings, adjust CPU/ Memory/PCI-E frequency manually, or create and apply your personal overclocking configurations.

5.4 RAID configurations

The motherboard comes with the Intel® ICH9R Southbridge RAID controller that allows you to configure IDE and Serial ATA hard disk drives as RAID sets.

5.4.1 RAID definitions

RAID 0 (Data striping) optimizes two identical hard disk drives to read and write data in parallel, interleaved stacks. Two hard disks perform the same work as a single drive but at a sustained data transfer rate, double that of a single disk alone, thus improving data access and storage. Use of two new identical hard disk drives is required for this setup.

RAID 1 (Data mirroring) copies and maintains an identical image of data from one drive to a second drive. If one drive fails, the disk array management software directs all applications to the surviving drive as it contains a complete copy of the data in the other drive. This RAID configuration provides data protection and increases fault tolerance to the entire system. Use two new drives or use an existing drive and a new drive for this setup. The new drive must be of the same size or larger than the existing drive.

RAID 10 is data striping and data mirroring combined without parity (redundancy data) having to be calculated and written. With the RAID 10 configuration you get all the benefits of both RAID 0 and RAID 1 configurations. Use four new hard disk drives or use an existing drive and three new drives for this setup.

RAID 5 stripes both data and parity information across three or more hard disk drives. Among the advantages of RAID 5 configuration include better HDD performance, fault tolerance, and higher storage capacity. The RAID 5 configuration is best suited for transaction processing, relational database applications, enterprise resource planning, and other business systems. Use a minimum of three identical hard disk drives for this setup.

Intel® Matrix Storage. The Intel® Matrix Storage technology supported by the ICH9R chip allows you to create a RAID 0, RAID 1, RAID 5, and RAID 10 function to improve both system performance and data safety. You can also combine two RAID sets to get higher performance, capacity, or fault tolerance provided by the difference RAID function. For example, RAID 0 and RAID 1 set can be created by using only two identical hard disk drives.



If you want to boot the system from a hard disk drive included in a created RAID set, copy first the RAID driver from the support DVD to a floppy disk/USB device before you install an operating system to the selected hard disk drive. Refer to section 5.5 **Creating a RAID driver disk** for details.

5.4.2 Installing Serial ATA hard disks

The motherboard supports Serial ATA hard disk drives. For optimal performance, install identical drives of the same model and capacity when creating a disk array.

To install the SATA hard disks for a RAID configuration:

1. Install the SATA hard disks into the drive bays.
2. Connect the SATA signal cables.
3. Connect a SATA power cable to the power connector on each drive.

5.4.3 Intel® RAID configurations

This motherboard supports RAID 0, RAID 1, RAID 5, RAID 10 (0+1) and Intel® Matrix Storage configurations for Serial ATA hard disks drives through the Intel® ICH8R Southbridge chip.

Setting the RAID item in BIOS

You must set the RAID item in the BIOS Setup before you can create a RAID set(s). To do this:

1. Enter the BIOS Setup during POST.
2. Go to the Main Menu, select IDE Configuration, then press <Enter>.
3. Select the item Configure SATA As, then press <Enter> to display the configuration options.
4. Select RAID from the Configure SATA As item options, then press <Enter>.
5. Select the item Onboard Serial-ATA BOOTROM, press <Enter>, then select Enabled from the options.
6. Save your changes, then exit the BIOS Setup.



Refer to the system or the motherboard user guide for details on entering and navigating through the BIOS Setup.

Intel® Matrix Storage Manager Option ROM Utility

The Intel® Matrix Storage Manager Option ROM utility allows you to create RAID 0, RAID 1, RAID 10 (RAID 0+1), and RAID 5 set(s) from Serial ATA hard disk drives that are connected to the Serial ATA connectors supported by the Southbridge.

To enter the Intel® Application Accelerator RAID Option ROM utility:

1. Install all the Serial ATA hard disk drives.
2. Turn on the system.
3. During POST, press <Ctrl+I> to display the utility main menu.

```
Intel(R) Matrix Storage Manager Option ROM v5.0.0.1032 ICH9R wRAID5
Copyright(C) 2003-05 Intel Corporation. All Rights Reserved.

[ MAIN MENU ]
1. Create RAID Volume
2. Delete RAID Volume
3. Reset Disks to Non-RAID
4. Exit

[ DISK/VOLUME INFORMATION ]

RAID Volumes:
None defined.

Physical Disks:
Port Drive Model      Serial #      Size      Type/Status (Vol ID)
0  XXXXXXXXXXXX      XXXXXXXX    XX.XXGB  Non-RAID Disk
1  XXXXXXXXXXXX      XXXXXXXX    XX.XXGB  Non-RAID Disk
2  XXXXXXXXXXXX      XXXXXXXX    XX.XXGB  Non-RAID Disk
3  XXXXXXXXXXXX      XXXXXXXX    XX.XXGB  Non-RAID Disk

[↑↓]-Select      [ESC]-Exit      [ENTER]-Select Menu
```

The navigation keys at the bottom of the screen allow you to move through the menus and select the menu options.



The RAID BIOS setup screens shown in this section are for reference only and may not exactly match the items on your screen.

Creating a RAID 0 set (striped)

To create a RAID 0 set:

1. From the utility main menu, select 1. Create RAID Volume, then press <Enter>. This screen appears.

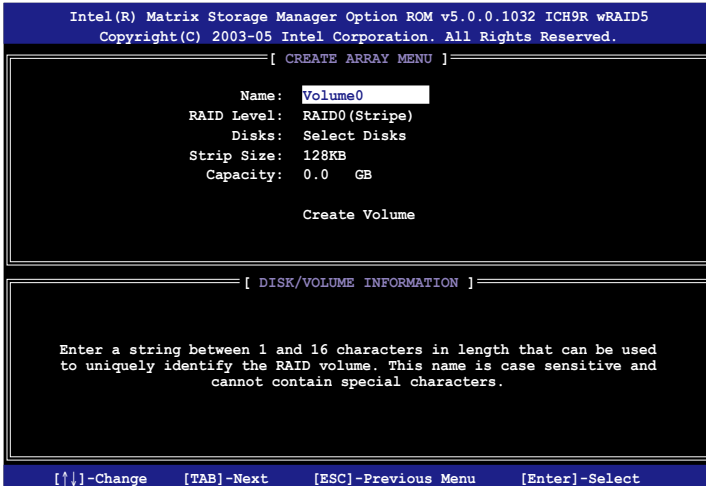

2. Enter a name for the RAID 0 set, then press <Enter>.
3. When the RAID Level item is highlighted, press the up/down arrow key to select RAID 0(Stripe), then press <Enter>.
4. When the Disks item is highlighted, press <Enter> to select the hard disk drives to configure as RAID. This pop-up screen appears.

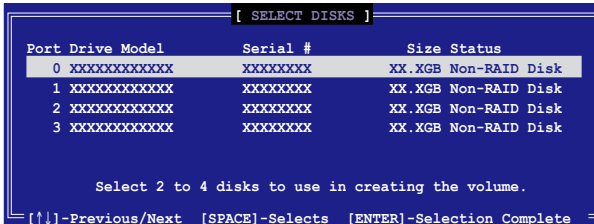

5. Use the up/down arrow key to highlight a drive, then press <Space> to select. A small triangle marks the selected drive. Press <Enter> after completing your selection.

6. Use the up/down arrow key to select the stripe size for the RAID 0 array, then press <Enter>. The available stripe size values range from 4 KB to 128 KB. The default stripe size is 128 KB.



TIP: We recommend a lower stripe size for server systems, and a higher stripe size for multimedia computer systems used mainly for audio and video editing.

7. Key in the RAID volume capacity that you want, then press <Enter>. The default value indicates the maximum allowed capacity.
8. Press <Enter> when the Create Volume item is highlighted. This warning message appears.

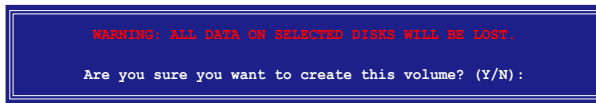

9. Press <Y> to create the RAID volume and return to the main menu, or <N> to go back to the Create Volume menu.

Creating a RAID 1 set (mirrored)

To create a RAID 1 set:

1. From the utility main menu, select 1. Create RAID Volume, then press <Enter>. This screen appears.

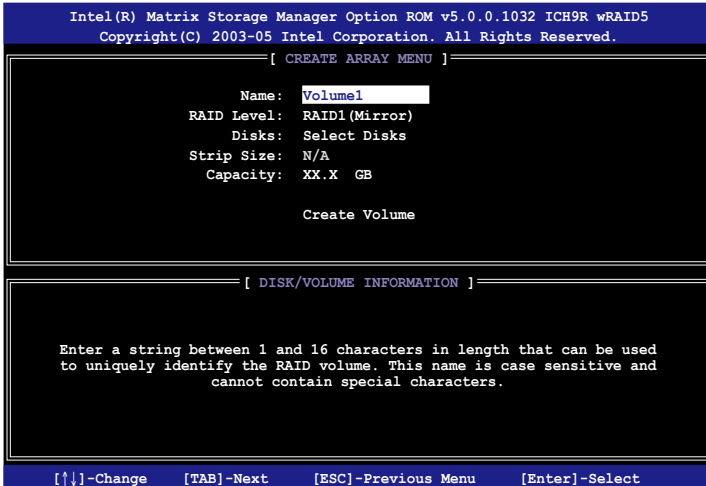

2. Enter a name for the RAID 1 set, then press <Enter>.
3. When the RAID Level item is highlighted, press the up/down arrow key to select RAID 1(Mirror), then press <Enter>.
4. When the Capacity item is highlighted, key in the RAID volume capacity that you want, then press <Enter>. The default value indicates the maximum allowed capacity.
5. Press <Enter> when the Create Volume item is highlighted. This warning message appears.

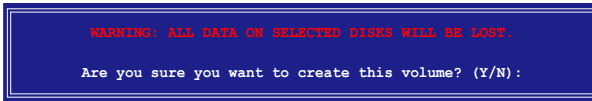

6. Press <Y> to create the RAID volume and return to main menu or <N> to go back to Create Volume menu.

Creating a RAID 10 set (RAID 0+1)

To create a RAID 10 set:

1. From the utility main menu, select 1. Create RAID Volume, then press <Enter>. This screen appears.

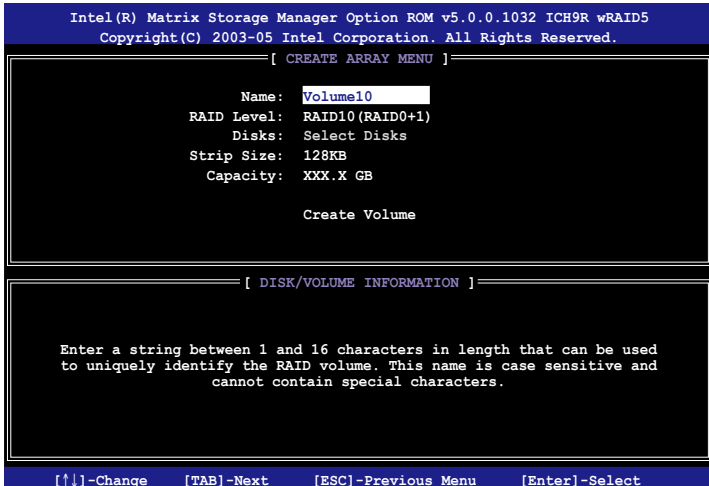

2. Enter a name for the RAID 10 set, then press <Enter>.
3. When the RAID Level item is highlighted, press the up/down arrow key to select RAID 10 (RAID 0+1), then press <Enter>.
4. When the Stripe Size item is highlighted, press the up/down arrow key to select the stripe size for the RAID 10 array, then press <Enter>. The available stripe size values range from 4 KB to 128 KB. The default stripe size is 64 KB.



TIP: We recommend a lower stripe size for server systems, and a higher stripe size for multimedia computer systems used mainly for audio and video editing.

5. Key in the RAID volume capacity that you want then press <Enter> when the Capacity item is highlighted. The default value indicates the maximum allowed capacity.

- Press <Enter> when the Create Volume item is highlighted. This warning message appears.

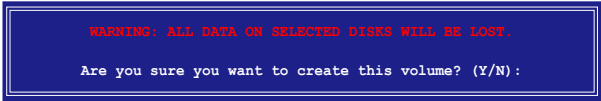

- Press <Y> to create the RAID volume and return to the main menu or <N> to go back to the Create Volume menu.

Creating a RAID 5 set (parity)

To create a RAID 5 set:

- From the utility main menu, select 1. Create RAID Volume, then press <Enter>. This screen appears.

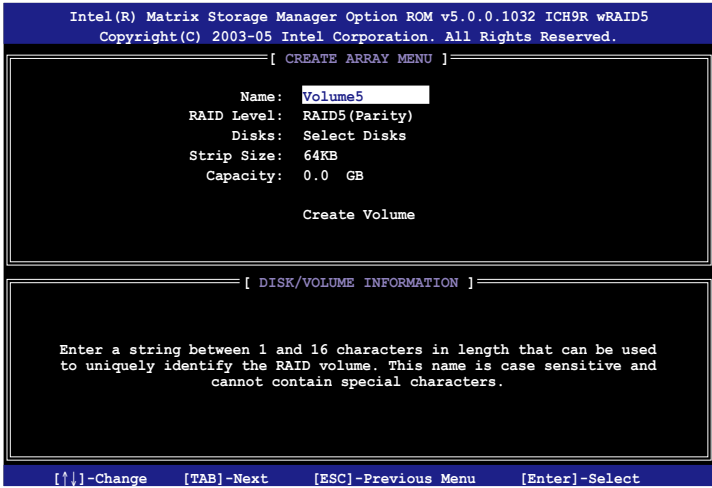

- Enter a name for the RAID 5 set, then press <Enter>.
- When the RAID Level item is highlighted, press the up/down arrow key to select RAID 5(Parity), then press <Enter>.

- The Disks item is highlighted, press <Enter> to select the hard disk drives to configure as RAID. The following pop-up screen appears.

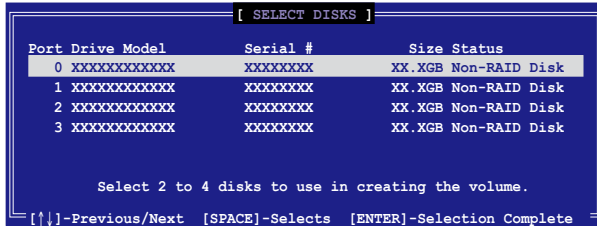

- Use the up/down arrow key to highlight the drive you want to set, then press <Space> to select. A small triangle marks the selected drive. Press <Enter> after completing your selection.
- When the Stripe Size item is highlighted, press the up/down arrow key to select the stripe size for the RAID 5 array, then press <Enter>. The available stripe size values range from 4 KB to 128 KB. The default stripe size is 64 KB.



TIP: We recommend a lower stripe size for server systems, and a higher stripe size for multimedia computer systems used mainly for audio and video editing.

- Key in the RAID volume capacity that you want, then press <Enter> when the Capacity item is highlighted. The default value indicates the maximum allowed capacity.
- Press <Enter> when the Create Volume item is highlighted. This warning message appears.



- Press <Y> to create the RAID volume and return to the main menu or <N> to go back to the Create Volume menu.

5.5 Creating a RAID driver disk

A floppy disk with the RAID driver is required when installing Windows® XP operating system on a hard disk drive that is included in a RAID set. For Windows® Vista™ operating system, use either a floppy disk or a USB device with the RAID driver.

5.5.1 Creating a RAID driver disk without entering the OS

To create a RAID/SATA driver disk without entering the OS:

1. Boot your computer.
2. Press during POST to enter the BIOS setup utility.
3. Set the optical drive as the primary boot device.
4. Insert the support CD into the optical drive.
5. Save changes and exit BIOS.
6. Press any key when the system prompts “Press any key to boot from the optical drive.”
7. When the menu appears, press <1> to create a RAID driver disk.
8. Insert a formatted floppy disk into the floppy drive then press <Enter>.
9. Follow succeeding screen instructions to complete the process.

5.5.2 Creating a RAID/SATA driver disk in Windows®

To create a RAID driver disk in Windows®:

1. Start Windows®.
2. Place the motherboard support DVD into the optical drive.
3. Go to the Make Disk menu, then click **Intel ICH9R 32/64bit RAID Driver** to create an Intel® ICH9R RAID driver disk.
4. Insert a floppy disk/USB device into the floppy disk drive/USB port.
5. Follow succeeding screen instructions to complete the process.



Write-protect the floppy disk to avoid computer virus infection.

To install the RAID driver in Windows® XP:

1. During the OS installation, the system prompts you to press the F6 key to install third-party SCSI or RAID driver.
2. Press <F6> then insert the floppy disk with RAID driver into the floppy disk drive.
3. When prompted to select the SCSI adapter to install, make sure you select **ICH9R**.
4. Follow the succeeding screen instructions to complete the installation.

To install the RAID driver in Windows® Vista™ :

1. Insert the floppy disk/USB device with RAID driver into the floppy disk drive/USB port.
2. During the OS installation, select **Intel ICH9R**.
3. Follow the succeeding screen instructions to complete the installation.

The Appendix describes the CPU features and technologies that the motherboard supports as well as the debug code table for the LCD Poster.

CPU features



Chapter summary



A.1	Intel® EM64T.....	A-1
A.2	Enhanced Intel SpeedStep® Technology (EIST).....	A-1
A.3	Intel® Hyper-Threading Technology	A-3
A.4	Debug Code Table.....	A-4

A.1 Intel® EM64T



- The motherboard is fully compatible with Intel® LGA775 processors running on 32-bit operating systems.
- The motherboard comes with a BIOS file that supports EM64T. You can download the latest BIOS file from the ASUS website (www.asus.com/support/download/) if you need to update the BIOS file. See Chapter 4 for details.
- Visit www.intel.com for more information on the EM64T feature.
- Visit www.microsoft.com for more information on Windows® 64-bit OS.

Using the Intel® EM64T feature

To use the Intel® EM64T feature:

1. Install an Intel® CPU that supports the Intel® EM64T.
2. Install a 64-bit operating system (Windows® Vista 64-bit Edition or Windows® XP Professional x64 Edition).
3. Install the 64-bit drivers for the motherboard components and devices from the support DVD.
4. Install the 64-bit drivers for expansion cards or add-on devices, if any.



Refer to the expansion card or add-on device(s) documentation, or visit the related website, to verify if the card/device supports a 64-bit system.

A.2 Enhanced Intel SpeedStep® Technology (EIST)



- The motherboard comes with a BIOS file that supports EIST. You can download the latest BIOS file from the ASUS website (www.asus.com/support/download/) if you need to update the BIOS. See Chapter 4 for details.
- Visit www.intel.com for more information on the EIST feature.

A.2.1 System requirements

Before using EIST, check your system if it meets the following requirements:

- Intel® processor with EIST support
- BIOS file with EIST support
- Operating system with EIST support (Windows® Vista, Windows® XP SP2/ Linux 2.6 kernel or later versions).

A.2.2 Using the EIST

To use the EIST feature:

1. Turn on the computer, then enter the BIOS Setup.
2. Go to the Advanced Menu, highlight CPU Configuration, then press <Enter>.
3. Set the Intel(R) SpeedStep Technology item to [Automatic], then press <Enter>. See page 4-25 for details.
4. Press <F10> to save your changes and exit the BIOS setup.
5. After the computer restarts, right click on a blank space on the desktop, then select Properties from the pop-up menu.
6. When the Display Properties window appears, click the Screen Saver tab.
7. Click the Power button on the Monitor power section to open the Power Options Properties window.

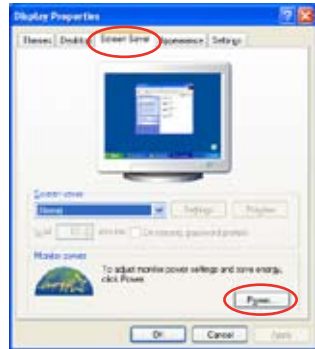

8. On the Power schemes section, click , then select any option except Home/Office Desktop or Always On.
9. Click Apply, then click OK.
10. Close the Display Properties window.

After you adjust the power scheme, the CPU internal frequency slightly decreases when the CPU loading is low.

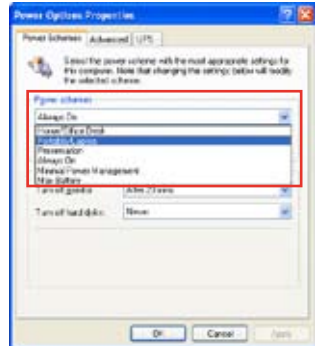

The screen displays and procedures may vary depending on the operating system.

A.3 Intel® Hyper-Threading Technology



- The motherboard supports Intel® Pentium® 4 LGA775 processors with Hyper-Threading Technology.
 - Hyper-Threading Technology is supported under Windows® Vista/XP and Linux 2.4.x (kernel) and later versions only. Under Linux, use the Hyper-Threading compiler to compile the code. If you are using any other operating systems, disable the Hyper-Threading Technology item in the BIOS to ensure system stability and performance.
 - Installing Windows® XP Service Pack 1 or later version is recommended.
 - Make sure to enable the Hyper-Threading Technology item in BIOS before installing a supported operating system.
 - For more information on Hyper-Threading Technology, visit www.intel.com/info/hyperthreading.
-

Using the Hyper-Threading Technology

To use the Hyper-Threading Technology:

1. Install an Intel® Pentium® 4 CPU that supports Hyper-Threading Technology.
2. Power up the system and enter the BIOS Setup. Under the Advanced Menu, make sure that the item **Hyper-Threading Technology** is set to [Enabled].
The BIOS item appears only if you installed a CPU that supports Hyper-Threading Technology.
3. Restart the computer.

A.4 Debug Code Table

Code	Description
CPU INIT	CPU Initiation
DET CPU	Test CMOS R/W functionality.
CHIPINIT	Early chipset initialization: -Disable shadow RAM -Disable L2 cache (socket 7 or below) -Program basic chipset registers
DET DRAM	Detect memory -Auto-detection of DRAM size, type and ECC. -Auto-detection of L2 cache (socket 7 or below)
DC FCODE	Expand compressed BIOS code to DRAM
EFSHADOW	Call chipset hook to copy BIOS back to E000 & F000 shadow RAM.
DC XCODE	Expand the Xgroup codes locating in physical address 1000:0
INIT IO	Initial Superio_Early_Init switch.
CLR SCRN	1. Blank out screen 2. Clear CMOS error flag
INIT8042	1. Clear 8042 interface 2. Initialize 8042 self-test
ENABLEKB	1. Test special keyboard controller for Winbond 977 series Super I/O chips. 2. Enable keyboard interface.
DIS MS	1. Disable PS/2 mouse interface (optional). 2. Auto detect ports for keyboard & mouse followed by a port & interface swap (optional). 3. Reset keyboard for Winbond 977 series Super I/O chips.
R/W FSEG	Test F000h segment shadow to see whether it is R/W-able or not. If test fails, keep beeping the speaker.
DET FLASH	Auto detect flash type to load appropriate flash R/W codes into the run time area in F000 for ESCD & DMI support.
TESTCMOS	Use walking 1's algorithm to check out interface in CMOS circuitry. Also set real-time clock power status, and then check for override.
PRG CHIP	Program chipset default values into chipset. Chipset default values are MODBINable by OEM customers.
INIT CLK	Initial Early_Init_Onboard_Generator switch.
CHECKCPU	Detect CPU information including brand, SMI type (Cyrix or Intel) and CPU level (586 or 686).
INTRINIT	Initial interrupts vector table. If no special specified, all H/W interrupts are directed to SPURIOUS_INT_HDLR & S/W interrupts to SPURIOUS_soft_HDLR.
REC MPS	Initial EARLY_PM_INIT switch.
Reserved	Load keyboard matrix (notebook platform)
Reserved	HPM initialization (notebook platform)
SET FDD	1. Check validity of RTC value: e.g. a value of 5Ah is an invalid value for RTC minute. 2. Load CMOS settings into BIOS stack. If CMOS checksum fails, use default value instead. 3. Prepare BIOS resource map for PCI & PnP use. If ESCD is valid, take into consideration of the ESCD's legacy information. 4. Onboard clock generator initialization. Disable respective clock resource to empty PCI & DIMM slots. 5. Early PCI initialization: -Enumerate PCI bus number -Assign memory & I/O resource -Search for a valid VGA device & VGA BIOS, and put it into C000:0.
INITINT9	Initialize INT 09 buffer

CPUSPEED	<ol style="list-style-type: none"> 1. Program CPU internal MTRR (P6 & PII) for 0-640K memory address. 2. Initialize the APIC for Pentium class CPU. 3. Program early chipset according to CMOS setup. Example: onboard IDE controller. 4. Measure CPU speed. 5. Invoke video BIOS.
TESTVRAM	<ol style="list-style-type: none"> 1. Initialize multi-language 2. Put information on screen display, including Award title, CPU type, CPU speed .
RESET KB	Reset keyboard except Winbond 977 series Super I/O chips.
8254TEST	Test 8254
8259MSK1	Test 8259 interrupt mask bits for channel 1.
8259MSK2	Test 8259 interrupt mask bits for channel 2.
8259TEST	Test 8259 functionality.
Reserved	Initialize EISA slot
COUNTMEM	<ol style="list-style-type: none"> 1. Calculate total memory by testing the last double word of each 64K page. 2. Program write allocation for AMD K5 CPU.
MP INIT	<ol style="list-style-type: none"> 1. Program MTRR of M1 CPU 2. Initialize L2 cache for P6 class CPU & program CPU with proper cacheable range. 3. Initialize the APIC for P6 class CPU. 4. On MP platform, adjust the cacheable range to smaller one in case the cacheable ranges between each CPU are not identical.
USB INIT	Initialize USB
TEST MEM	Test all memory (clear all extended memory to 0)
SHOW MP	Display number of processors (multi-processor platform)
PNP LOGO	<ol style="list-style-type: none"> 1. Display PnP logo 2. Early ISA PnP initialization -Assign CSN to every ISA PnP device.
Reserved	Initialize the combined Trend Anti-Virus code.
SHOW EZF	(Optional Feature) Show message for entering AWDFLASH.EXE from FDD (optional)
ONBD IO	<ol style="list-style-type: none"> 1. Initialize Init_Onboard_Super_IO switch. 2. Initialize Init_Onboard_AUDIO switch.
EN SETUP	Okay to enter Setup utility; i.e. not until this POST stage can users enter the CMOS setup utility.
MSINSTAL	Initialize PS/2 Mouse
CHK ACPI	Prepare memory size information for function call: INT 15h ax=E820h
EN CACHE	Turn on L2 cache
SET CHIP	Program chipset registers according to items described in Setup & Auto-configuration table.
AUTO CFG	<ol style="list-style-type: none"> 1. Assign resources to all ISA PnP devices. 2. Auto assign ports to onboard COM ports if the corresponding item in Setup is set to "AUTO".
INIT FDC	<ol style="list-style-type: none"> 1. Initialize floppy controller 2. Set up floppy related fields in 40:hardware.
CUTIRQ12	(Optional Feature) Enter AWDFLASH.EXE if : -AWDFLASH is found in floppy drive. -ALT+F2 is pressed
DET IDE	Detect & install all IDE devices: HDD, LS120, ZIP, CDROM.....
COM/LPT	Detect serial ports & parallel ports.
DET FPU	Detect & install co-processor

CPU CHG	CPU change
CPR FAIL	CPR error
FAN FAIL	Fan error
UCODEERR	UCODE error
FLOPYERR	Floppy error
KB ERROR	Keyboard error
HD ERR	HDD error
CMOS ERR	CMOS error
MS ERROR	Mouse error
80P ERR	80 port error
BOOT CHG	Boot device change
SMARTERR	HDD smart function error
HM ERROR	Hard monitor error
AINETERR	AI NET error
CASEOPEN	Case open
PASSWORD	Clear EPA or customization logo. 1. Call chipset power management hook. 2. Recover the text fond used by EPA logo (not for full screen logo) 3. If password is set, ask for password.
MEM2CMOS	Save all data in stack back to CMOS
INIT PNP USB FINAL	Initialize ISA PnP boot devices 1. USB final Initialization 2. NET PC: Build SYSID structure 3. Switch screen back to text mode 4. Set up ACPI table at top of memory. 5. Invoke ISA adapter ROMs 6. Assign IRQs to PCI devices 7. Initialize APM 8. Clear noise of IRQs.
READ HDD BOOTMENU	Read HDD boot sector information for Trend Anti-Virus code 1. Enable L2 cache 2. Program boot up speed 3. Chipset final initialization. 4. Power management final initialization 5. Clear screen & display summary table 6. Program K6 write allocation 7. Program P6 class write combining
NUM LOCK	1. Program daylight saving 2. Update keyboard LED & typematic rate
UPDT DMI	1. Build MP table 2. Build & update ESCD 3. Set CMOS century to 20h or 19h 4. Load CMOS time into DOS timer tick 5. Build MSIRQ routing table.
INT 19H	Boot attempt (INT 19h)