

P5MT-M

ASUS[®]

Motherboard

E2094

First Edition

July 2005

Copyright © 2005 ASUSTeK COMPUTER INC. All Rights Reserved.

No part of this manual, including the products and software described in it, may be reproduced, transmitted, transcribed, stored in a retrieval system, or translated into any language in any form or by any means, except documentation kept by the purchaser for backup purposes, without the express written permission of ASUSTeK COMPUTER INC. ("ASUS").

Product warranty or service will not be extended if: (1) the product is repaired, modified or altered, unless such repair, modification or alteration is authorized in writing by ASUS; or (2) the serial number of the product is defaced or missing.

ASUS PROVIDES THIS MANUAL "AS IS" WITHOUT WARRANTY OF ANY KIND, EITHER EXPRESS OR IMPLIED, INCLUDING BUT NOT LIMITED TO THE IMPLIED WARRANTIES OR CONDITIONS OF MERCHANTABILITY OR FITNESS FOR A PARTICULAR PURPOSE. IN NO EVENT SHALL ASUS, ITS DIRECTORS, OFFICERS, EMPLOYEES OR AGENTS BE LIABLE FOR ANY INDIRECT, SPECIAL, INCIDENTAL, OR CONSEQUENTIAL DAMAGES (INCLUDING DAMAGES FOR LOSS OF PROFITS, LOSS OF BUSINESS, LOSS OF USE OR DATA, INTERRUPTION OF BUSINESS AND THE LIKE), EVEN IF ASUS HAS BEEN ADVISED OF THE POSSIBILITY OF SUCH DAMAGES ARISING FROM ANY DEFECT OR ERROR IN THIS MANUAL OR PRODUCT.

SPECIFICATIONS AND INFORMATION CONTAINED IN THIS MANUAL ARE FURNISHED FOR INFORMATIONAL USE ONLY, AND ARE SUBJECT TO CHANGE AT ANY TIME WITHOUT NOTICE, AND SHOULD NOT BE CONSTRUED AS A COMMITMENT BY ASUS. ASUS ASSUMES NO RESPONSIBILITY OR LIABILITY FOR ANY ERRORS OR INACCURACIES THAT MAY APPEAR IN THIS MANUAL, INCLUDING THE PRODUCTS AND SOFTWARE DESCRIBED IN IT.

Products and corporate names appearing in this manual may or may not be registered trademarks or copyrights of their respective companies, and are used only for identification or explanation and to the owners' benefit, without intent to infringe.

Contents

Notices	vi
Safety information	vii
About this guide	viii
P5MT-M specifications summary	x

Chapter 1: Product introduction

1.1	Welcome!	1-1
1.2	Package contents	1-1
1.3	Special features	1-2
1.3.1	Product highlights	1-2
1.3.2	Innovative ASUS features	1-4

Chapter 2: Hardware information

2.1	Before you proceed	2-1
2.2	Motherboard overview	2-2
2.2.1	Placement direction	2-2
2.2.2	Screw holes	2-2
2.2.3	Motherboard layout	2-3
2.2.4	Layout contents	2-4
2.3	Central Processing Unit (CPU)	2-6
2.3.1	Installing the CPU	2-6
2.3.2	Installing the CPU heatsink and fan	2-9
2.3.3	Uninstalling the CPU heatsink and fan	2-11
2.4	System memory	2-13
2.4.1	Overview	2-13
2.4.2	Memory configurations	2-13
2.4.3	Installing a DIMM	2-15
2.4.4	Removing a DIMM	2-15
2.5	Expansion slots	2-16
2.5.1	Installing an expansion card	2-16
2.5.2	Configuring an expansion card	2-16
2.5.3	Interrupt assignments	2-17
2.5.4	PCI Express x8 slots	2-18
2.5.5	PCI slots	2-18
2.6	Jumpers	2-19
2.7	Connectors	2-24
2.7.1	Rear panel connectors	2-24
2.7.2	Internal connectors	2-25

Contents

Chapter 3: Powering up

- 3.1 Starting up for the first time 3-1
- 3.2 Turning off the computer 3-2
 - 3.2.1 Using the OS shut down function 3-2
 - 3.2.2 Using the dual function power switch 3-2

Chapter 4: BIOS setup

- 4.1 Managing and updating your BIOS 4-1
 - 4.1.1 Creating a bootable floppy disk 4-1
 - 4.1.2 ASUS EZ Flash utility 4-2
 - 4.1.3 AFUDOS utility 4-3
 - 4.1.4 ASUS CrashFree BIOS 2 utility 4-6
 - 4.1.5 ASUS Update utility 4-8
- 4.2 BIOS setup program 4-11
 - 4.2.1 BIOS menu screen 4-12
 - 4.2.2 Menu bar 4-12
 - 4.2.3 Navigation keys 4-12
 - 4.2.4 Menu items 4-13
 - 4.2.5 Sub-menu items 4-13
 - 4.2.6 Configuration fields 4-13
 - 4.2.7 Pop-up window 4-13
 - 4.2.8 Scroll bar 4-13
 - 4.2.9 General help 4-13
- 4.3 Main menu 4-14
 - 4.3.1 System Time 4-14
 - 4.3.2 System Date 4-14
 - 4.3.3 Legacy Diskette A 4-14
 - 4.3.4 Primary, Third, and Fourth IDE Master/Slave 4-15
 - 4.3.5 IDE Configuration 4-16
 - 4.3.6 System Information 4-18
- 4.4 Advanced menu 4-19
 - 4.4.1 USB Configuration 4-19
 - 4.4.2 MPS Configuration 4-20
 - 4.4.3 Remote Access Configuration 4-21
 - 4.4.4 CPU Configuration 4-22
 - 4.4.5 Chipset 4-23
 - 4.4.6 Onboard Devices Configuration 4-25
 - 4.4.7 PCI PnP 4-26

Contents

4.5	Power menu	4-27
4.5.1	ACPI APIC Support [Enabled]	4-27
4.5.2	APM Configuration	4-28
4.5.3	Hardware Monitor	4-29
4.6	Boot menu	4-31
4.6.1	Boot Device Priority	4-31
4.6.2	Boot Settings Configuration	4-32
4.6.3	Security	4-33
4.7	Exit menu	4-35

Chapter 5: RAID support

5.1	RAID configuration	5-1
5.1.1	RAID definitions	5-1
5.1.2	Installing Serial ATA hard disks	5-2
5.1.3	Intel® RAID configurations	5-2
5.1.4	LSI Logic Embedded SATA RAID Setup Utility	5-13

Chapter 6: Driver installation

6.1	RAID driver installation	6-1
6.1.1	Creating a RAID driver disk	6-1
6.1.2	Installing the Intel® ICH7R RAID controller driver	6-3
6.2	LAN driver installation	6-7
6.2.1	Windows® 2000/2003 Server	6-7
6.2.2	Red Hat® Linux 9.0	6-9
6.3	VGA driver installation	6-11
6.3.1	Windows® 2000 Server	6-11
6.3.2	Windows® 2003 Server	6-12
6.3.3	Red Hat® Linux 9.0	6-12

Appendix: Reference information

A.1	P5MT-M block diagram	A-1
-----	----------------------------	-----

Notices

Federal Communications Commission Statement

This device complies with Part 15 of the FCC Rules. Operation is subject to the following two conditions:

- This device may not cause harmful interference, and
- This device must accept any interference received including interference that may cause undesired operation.

This equipment has been tested and found to comply with the limits for a Class B digital device, pursuant to Part 15 of the FCC Rules. These limits are designed to provide reasonable protection against harmful interference in a residential installation. This equipment generates, uses and can radiate radio frequency energy and, if not installed and used in accordance with manufacturer's instructions, may cause harmful interference to radio communications. However, there is no guarantee that interference will not occur in a particular installation. If this equipment does cause harmful interference to radio or television reception, which can be determined by turning the equipment off and on, the user is encouraged to try to correct the interference by one or more of the following measures:

- Reorient or relocate the receiving antenna.
- Increase the separation between the equipment and receiver.
- Connect the equipment to an outlet on a circuit different from that to which the receiver is connected.
- Consult the dealer or an experienced radio/TV technician for help.



The use of shielded cables for connection of the monitor to the graphics card is required to assure compliance with FCC regulations. Changes or modifications to this unit not expressly approved by the party responsible for compliance could void the user's authority to operate this equipment.

Canadian Department of Communications Statement

This digital apparatus does not exceed the Class B limits for radio noise emissions from digital apparatus set out in the Radio Interference Regulations of the Canadian Department of Communications.

This class B digital apparatus complies with Canadian ICES-003.

Safety information

Electrical safety

- To prevent electrical shock hazard, disconnect the power cable from the electrical outlet before relocating the system.
- When adding or removing devices to or from the system, ensure that the power cables for the devices are unplugged before the signal cables are connected. If possible, disconnect all power cables from the existing system before you add a device.
- Before connecting or removing signal cables from the motherboard, ensure that all power cables are unplugged.
- Seek professional assistance before using an adapter or extension cord. These devices could interrupt the grounding circuit.
- Make sure that your power supply is set to the correct voltage in your area. If you are not sure about the voltage of the electrical outlet you are using, contact your local power company.
- If the power supply is broken, do not try to fix it by yourself. Contact a qualified service technician or your retailer.

Operation safety

- Before installing the motherboard and adding devices on it, carefully read all the manuals that came with the package.
- Before using the product, make sure all cables are correctly connected and the power cables are not damaged. If you detect any damage, contact your dealer immediately.
- To avoid short circuits, keep paper clips, screws, and staples away from connectors, slots, sockets and circuitry.
- Avoid dust, humidity, and temperature extremes. Do not place the product in any area where it may become wet.
- Place the product on a stable surface.
- If you encounter technical problems with the product, contact a qualified service technician or your retailer.

About this guide

This user guide contains the information you need when installing and configuring the motherboard.

How this guide is organized

This manual contains the following parts:

- **Chapter 1: Product introduction**
This chapter describes the features of the motherboard and the new technology it supports.
- **Chapter 2: Hardware information**
This chapter lists the hardware setup procedures that you have to perform when installing system components. It includes description of the switches, jumpers, and connectors on the motherboard.
- **Chapter 3: Powering up**
This chapter describes the power up sequence, the vocal POST messages, and ways of shutting down the system.
- **Chapter 4: BIOS setup**
Tells how to change system settings through the BIOS Setup menus. Detailed descriptions of the BIOS parameters are also provided.
- **Chapter 5: RAID support**
Provides information on RAID configurations for this motherboard.
- **Chapter 6: Driver installation**
This chapter provides information on RAID, LAN and VGA driver installation for this motherboard.
- **Appendix: Reference information**
This appendix includes additional information that you may refer to when configuring the motherboard.

Where to find more information

Refer to the following sources for additional information and for product and software updates.

1. ASUS websites

The ASUS website provides updated information on ASUS hardware and software products. Refer to the ASUS contact information.

2. Optional documentation

Your product package may include optional documentation, such as warranty flyers, that may have been added by your dealer. These documents are not part of the standard package.

Conventions used in this guide

To make sure that you perform certain tasks properly, take note of the following symbols used throughout this manual.



DANGER/WARNING: Information to prevent injury to yourself when trying to complete a task.



CAUTION: Information to prevent damage to the components when trying to complete a task.



IMPORTANT: Instructions that you **MUST** follow to complete a task.



NOTE: Tips and additional information to help you complete a task.

Typography

Bold text

Indicates a menu or an item to select.

Italics

Used to emphasize a word or a phrase.

<Key>

Keys enclosed in the less-than and greater-than sign means that you must press the enclosed key.

Example: <Enter> means that you must press the Enter or Return key.

<Key1+Key2+Key3>

If you must press two or more keys simultaneously, the key names are linked with a plus sign (+).

Example: <Ctrl+Alt+D>

Command

Means that you must type the command exactly as shown, then supply the required item or value enclosed in brackets.

Example: At the DOS prompt, type the command line:

```
afudos /i[filename]  
afudos /iP5MT-M.ROM
```

P5MT-M specifications summary

CPU	LGA775 socket for Intel® Pentium® Processor Extreme Edition/Intel® Pentium® D/Celeron processor with Extended Memory 64-bit Technology (EM64T) Supports Intel® Hyper-Threading Technology
Chipset	Northbridge: Intel® E7230 Southbridge: Intel® ICH7R
Front Side Bus	1066/800 MHz
Memory	Dual-channel memory architecture 4 x 240-pin DIMM sockets support unbuffered ECC 667/533 MHz DDR2 memory modules Supports 256 MB up to 8 GB of system memory
Expansion slots	1 x PCI Express™ x8 slot (x8 Link) 1 x PCI Express™ x8 slot (x4 Link) 2 x PCI 33 MHz slots (PCI 2.3)
Storage	Intel® ICH7R Southbridge supports: <ul style="list-style-type: none"> - 2 x Ultra DMA 100/66/33 hard disk drives - 4 x Serial ATA II hard disks with RAID 0, RAID 1, RAID 5, and RAID 10 configuration - Intel® Matrix Storage Technology 1 x mini-PCI socket for ASUS® Server Management Board
Graphics	ATI® RAGE-XL PCI-based VGA controller
LAN	Dual Broadcom BCM5721 Gigabit LAN controller (PCI Express 1.0a specifications compliant)
USB	Intel® ICH7R Southbridge supports: <ul style="list-style-type: none"> - 8 x USB 2.0 ports (2 on the rear panel, 3 connectors at mid-board for up to 6 additional ports)
Special features	ASUS Q-Fan ASUS CrashFree BIOS 2 ASUS MyLogo2™ ASUS EZ FLash
BIOS features	AMI BIOS, 8 Mb FWH, Green, PnP, DMI2.0a, ACPI 2.0a, SMBIOS 2.3
Rear panel	1 x PS/2 keyboard port 1 x PS/2 mouse port 2 x USB 2.0 ports 1 x Serial (COM1) port 2 x LAN (RJ-45) ports 1 x VGA port 1 x Parallel port

(continued on the next page)

P5MT-M specifications summary

Internal connectors	1 x Floppy disk drive connector 1 x Hard disk activity LED connector 1x IDE connector 4 x Serial ATA connectors 2 x CPU fan connectors 4 x System fan connectors 1 x Serial port (COM2) connector 3 x USB connectors 1 x Parallel port connector 1 x 24-pin SSI power connector 1 x 4-pin ATX 12 V power connector 1 x Backplane SMBus connector 1 x Power supply SMBus connector 1 x BMC connector 1 x Ambient thermal sensor connector 1 x System panel auxiliary connector 1 x System panel connector
Power Requirement	SSI power supply (with 24-pin and 4-pin 12 V plugs) ATX 12V 2.0 compliant
Form Factor	micro-ATX form factor: 9.6" x 9.6" (24.4 cm x 24.4 cm)
Support CD contents	Device drivers ASUS Update ASWM 2.0

*Specifications are subject to change without notice.

This chapter describes the motherboard features and the new technologies it supports.

Product introduction



Chapter summary



1.1	Welcome!	1-1
1.2	Package contents	1-1
1.3	Special features	1-2

1.1 Welcome!

Thank you for buying an ASUS® P5MT-M motherboard!

The motherboard delivers a host of new features and latest technologies, making it another standout in the long line of ASUS quality motherboards!

Before you start installing the motherboard, and hardware devices on it, check the items in your package with the list below.

1.2 Package contents

Check your motherboard package for the following items.

Motherboard	ASUS P5MT-M motherboard
Cables	2-in-1 disk drive cable 4 x Serial ATA signal cables 2 x Serial ATA power cable 1 x USB PCI cable bracket
Accessories	I/O shield
Application CD	ASUS motherboard support CD
Documentation	User guide



If any of the above items is damaged or missing, contact your retailer.

1.3 Special features

1.3.1 Product highlights

Latest processor technology

The motherboard comes with a 775-pin surface mount Land Grid Array (LGA) socket designed for the Intel® Pentium® Processor Extreme Edition and the Intel® Pentium® D processor in the 775-land package, with 1066/800 MHz Front Side Bus (FSB). See page 2-6 for details.

Intel® E7230/Intel® ICH7R chipset

The Intel® E7230 and the Intel® ICH7R I/O controller hub (ICH) provide the vital interfaces for the motherboard.

The uniprocessor server chipset integrates EM64T support and four Serial ATA ports enabled through the Serial ATA 3 Gb/s RAID controller to ensure data security and enable powerful multi-task processing.

Intel® EM64T

The motherboard supports the Intel® Hyper-Threading technology and incorporates the Extended Memory 64-bit Technology (EM64T). The Intel® EM64T feature allows your system to run on 64-bit operating systems and access larger amounts of system memory for faster and more efficient computing.

DDR2 memory support

The motherboard supports DDR2 memory, which features data transfer rates of 667 MHz or 533 MHz to meet the higher bandwidth requirements of the latest 3D graphics, multimedia, and Internet applications. The dual-channel DDR2 architecture doubles the bandwidth of your system memory to boost system performance, eliminating bottlenecks with peak bandwidths of up to 10.7 GB/s. See page 2-13 for details.

Serial ATA II technology

The motherboard supports the Serial ATA II technology through the Serial ATA II interfaces controlled by the Intel® ICH7R. The SATA II specification allows for thinner, more flexible cables with lower pin count, reduced voltage requirement, and up to 300 MB/s data transfer rate. See page 2-27 for details.

PCI Express™ interface

The motherboard fully supports PCI Express, the latest I/O interconnect technology that speeds up the PCI bus. PCI Express features point-to-point serial interconnections between devices and allows higher clockspeeds by carrying data in packets. This high speed interface is software compatible with existing PCI specifications. See page 2-18 for details.

Dual Gigabit LAN solution

The motherboard comes with onboard dual Gigabit LAN controllers to provide a total solution for your networking needs. The onboard Broadcom BCM5721 controllers use the PCI Express interface with a network throughput close to Gigabit bandwidth. See pages 2-21, 2-22, and 2-24 for details.

Serial ATA RAID solution

Onboard RAID controllers provide the motherboard with RAID functionality. The Intel® ICH7R allows RAID 0, RAID 1, RAID 5, and RAID 10 configuration for four Serial ATA connectors and supports the Intel® Matrix Technology. See page 2-27 for details.

USB 2.0 technology

The motherboard implements the Universal Serial Bus (USB) 2.0 specification, dramatically increasing the connection speed from the 12 Mbps bandwidth on USB 1.1 to a fast 480 Mbps on USB 2.0. USB 2.0 is backward compatible with USB 1.1. See pages 2-20 and 2-29 for details.

1.3.2 Innovative ASUS features

ASUS Smart Fan technology



The ASUS Smart Fan technology smartly adjusts the fan speeds according to the system loading to ensure quiet, cool, and efficient operation. See page 4-30 for details.

ASUS MyLogo2™



This feature allows you to personalize and add style to your system with customizable boot logos. See page 4-33 for details.

ASUS EZ Flash BIOS



With the ASUS EZ Flash, you can easily update the system BIOS even before loading the operating system. No need to use a DOS-based utility or boot from a floppy disk. See page 4-2 for details.

ASUS CrashFree BIOS 2



This feature allows you to restore the original BIOS data from the support CD in case when the BIOS codes and data are corrupted. This protection eliminates the need to buy a replacement ROM chip. See page 4-6 for details.

This chapter lists the hardware setup procedures that you have to perform when installing system components. It includes description of the jumpers and connectors on the motherboard.

Hardware information



Chapter summary



2.1	Before you proceed	2-1
2.2	Motherboard overview	2-2
2.3	Central Processing Unit (CPU)	2-6
2.4	System memory	2-13
2.5	Expansion slots	2-16
2.6	Jumpers	2-19
2.7	Connectors	2-24

2.1 Before you proceed

Take note of the following precautions before you install motherboard components or change any motherboard settings.



- Unplug the power cord from the wall socket before touching any component.
- Use a grounded wrist strap or touch a safely grounded object or a metal object, such as the power supply case, before handling components to avoid damaging them due to static electricity.
- Hold components by the edges to avoid touching the ICs on them.
- Whenever you uninstall any component, place it on a grounded antistatic pad or in the bag that came with the component.
- **Before you install or remove any component, ensure that the power supply is switched off or the power cord is detached from the power supply.** Failure to do so may cause severe damage to the motherboard, peripherals, and/or components.

Onboard LED

The motherboard comes with a standby power LED. The green LED lights up to indicate that the system is ON, in sleep mode, or in soft-off mode. This is a reminder that you should shut down the system and unplug the power cable before removing or plugging in any motherboard component. The illustration below shows the location of the onboard LED.

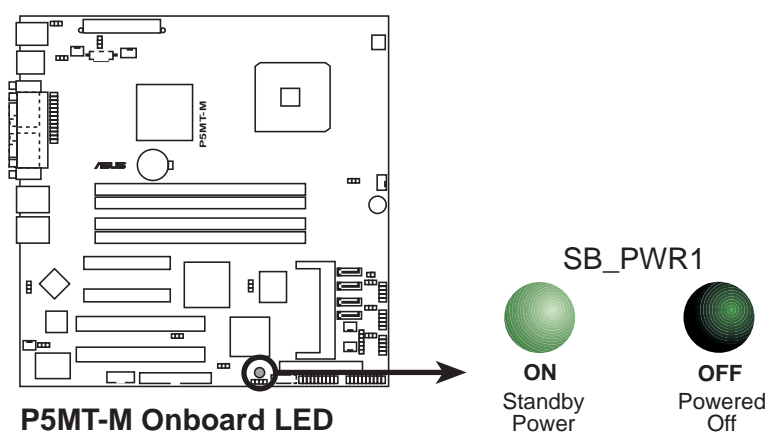

2.2 Motherboard overview

Before you install the motherboard, study the configuration of your chassis to ensure that the motherboard fits into it. Refer to the chassis documentation before installing the motherboard.



Make sure to unplug the chassis power cord before installing or removing the motherboard. Failure to do so can cause you physical injury and damage motherboard components.

2.2.1 Placement direction

When installing the motherboard, make sure that you place it into the chassis in the correct orientation. The edge with external ports goes to the rear part of the chassis as indicated in the image below.

2.2.2 Screw holes

Place eight (8) screws into the holes indicated by circles to secure the motherboard to the chassis.



Do not overtighten the screws! Doing so can damage the motherboard.

Place this side towards
the rear of the chassis

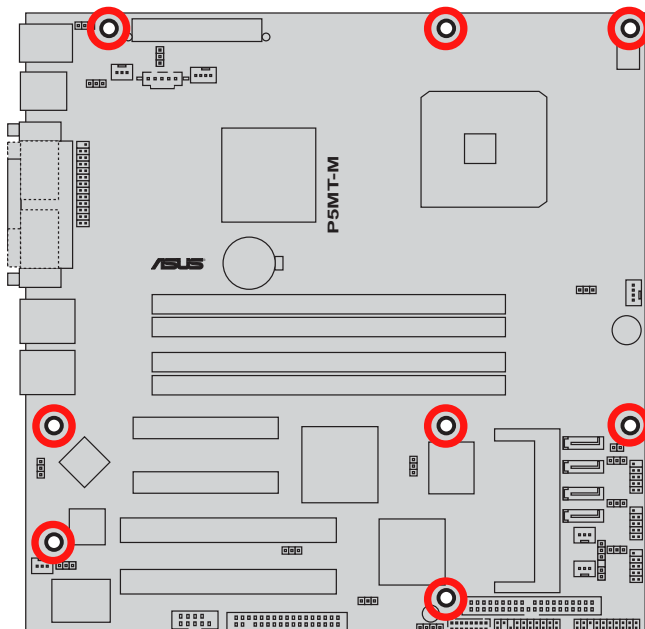

2.2.3 Motherboard layout

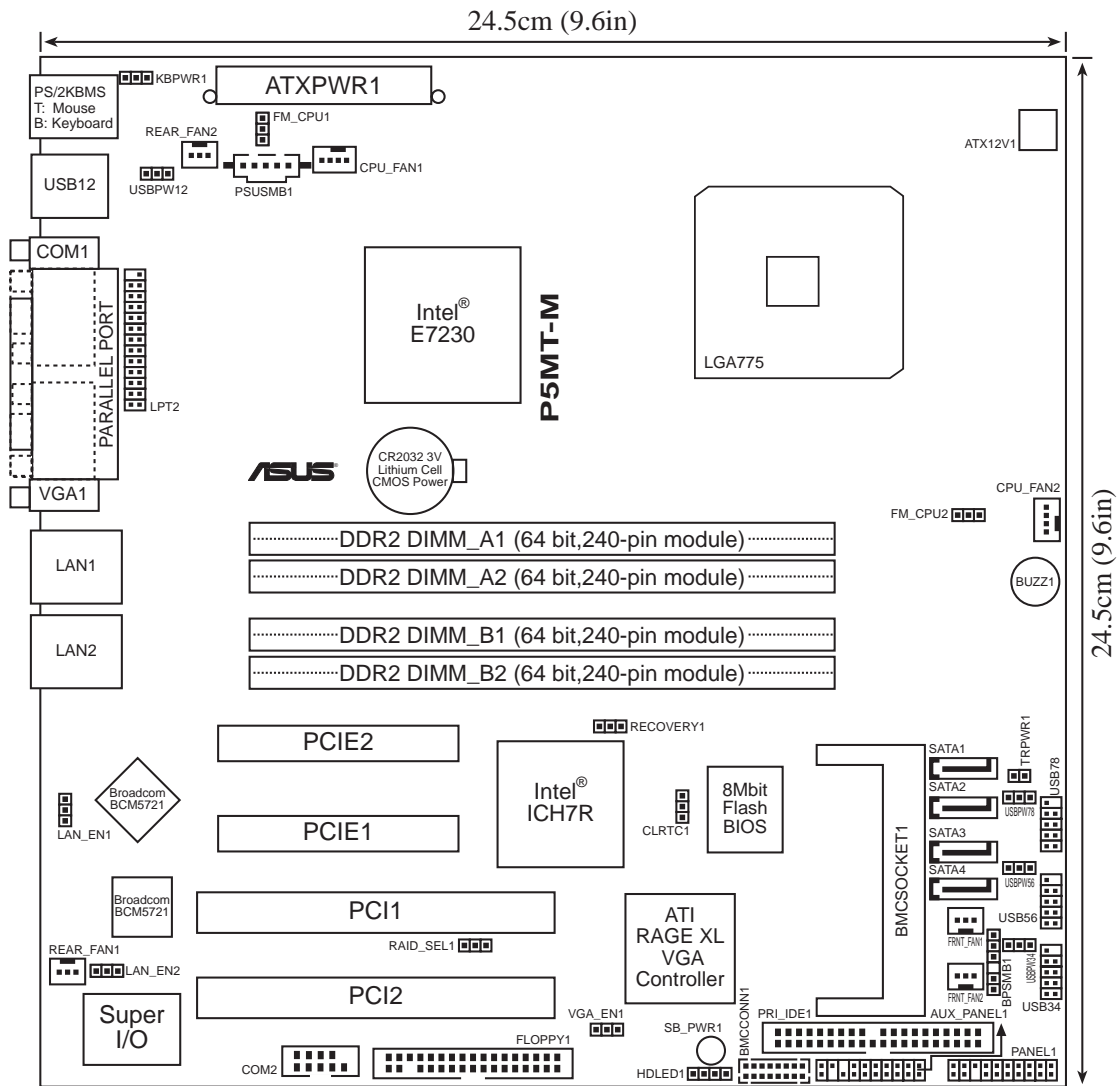

2.2.4 Layout contents

Slots	Page
1. CPU sockets	2-6
2. DDR2 DIMM sockets	2-13
3. PCI Express/PCI slots	2-18

Jumpers	Page
1. Clear RTC RAM (CLRRTC1)	2-19
2. CPU fan pin selection (3-pin FM_CPU1, FM_CPU2)	2-20
3. USB device wake-up (3-pin USBPW12, USBPW34, USBPW56, USBPW78)	2-20
4. Keyboard power (3-pin KBPWR1)	2-21
5. Gigabit LAN controller setting (3-pin LAN_EN1)	2-21
6. Gigabit LAN controller setting (3-pin LAN_EN2)	2-22
7. VGA graphics controller setting (3-pin VGA_EN1)	2-22
8. BIOS recovery (3-pin RECOVERY1)	2-23
9. RAID select (3-pin RAID_SEL1)	2-23

Rear panel connectors	Page
1. PS/2 mouse port (green)	2-24
2. Parallel port	2-24
3. PS/2 keyboard port (purple)	2-24
4. USB 2.0 ports 1 and 2	2-24
5. Serial (COM1) port	2-24
6. VGA port	2-24
7. LAN 1 (RJ-45) port	2-24
8. LAN 2 (RJ-45) port	2-24

Internal connectors	Page
1. Floppy disk drive connector (34-1 pin FLOPPY1)	2-25
2. Hard disk activity LED connector (4-pin HDLED1)	2-25
3. IDE connector (40-1 pin PRI_IDE1))	2-26
4. Serial ATA connectors (7-pin SATA1, SATA2, SATA3, SATA4)	2-27
5. CPU fan connectors (4-pin CPU_FAN1/CPU_FAN2))	2-28
6. System fan connectors (3-pin REAR_FAN1/REAR_FAN2, FRNT_FAN1/FRNT_FAN2)	2-28
7. Serial port connector (10-1 pin COM2)	2-28
8. USB connectors (10-1 pin USB34, USB56, USB78)	2-29
9. Parallel port connector (26-1 pin LPT2)	2-29
10. SSI power connectors (24-pin ATXPWR1, 4-pin ATX12V1)	2-30
11. Backplane SMBus connector (6-1 pin BPSMB1)	2-31
12. Power supply SMBus connector (6-1 pin PSUSMB1)	2-31
13. BMC connector (16-pin BMCCONN1)	2-32
14. Ambient thermal sensor connector (2-pin TRPWR1)	2-32
15. System panel auxiliary connector (20-pin AUX_PANEL1) <ul style="list-style-type: none"> • Chassis Intrusion connector (3-pin CASEOPEN) • LAN1 link activity LED (2-pin LAN1_LINKACTLED) • LAN2 link activity LED (2-pin LAN2_LINKACTLED) • Locator LED 1 (2-pin LOCATORLED1) • Locator LED 2 (2-pin LOCATORLED2) • Locator Button/Switch (2-pin LOCATORBTN) • Front Panel SMBus (6-1 pin) 	2-33
16. System panel connector (20-pin PANEL1) <ul style="list-style-type: none"> • System power LED (Green 3-pin POWERLED) • Hard disk drive activity LED (Red 2-pin HDLED) • System warning speaker (Orange 4-pin SPKROUT) • ATX power button/soft-off button (Yellow 2-pin POWERBTN) • Reset button (Blue 2-pin RESETBTN) 	2-34

2.3 Central Processing Unit (CPU)

The motherboard comes with a surface mount LGA775 socket designed for the Intel® Pentium® 4 processor in the 775-land package.



- Your boxed Intel® Pentium® 4 LGA775 processor package should come with installation instructions for the CPU and heatsink. If the instructions in this section do not match the CPU documentation, follow the latter.
- Upon purchase of the motherboard, make sure that the PnP cap is on the socket and the socket contacts are not bent. Contact your retailer immediately if the PnP cap is missing, or if you see any damage to the PnP cap/socket contacts/motherboard components. ASUS will shoulder the cost of repair only if the damage is shipment/transit-related.
- Keep the cap after installing the motherboard. ASUS will process Return Merchandise Authorization (RMA) requests only if the motherboard comes with the cap on the LGA775 socket.
- The product warranty does not cover damage to the socket contacts resulting from incorrect CPU installation/removal, or misplacement/loss/incorrect removal of the PnP cap.

2.3.1 Installing the CPU

To install a CPU:

1. Locate the CPU socket on the motherboard.

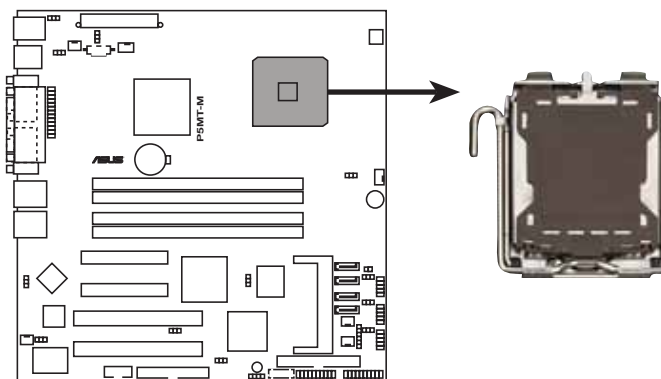

P5MT-M CPU Socket 775



Before installing the CPU, make sure that the socket box is facing towards you and the load lever is on your left.

2. Press the load lever with your thumb (A), then move it to the left (B) until it is released from the retention tab.

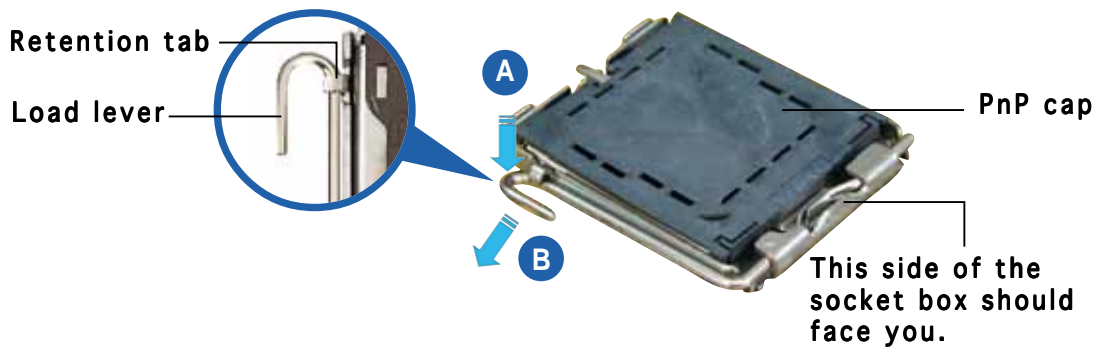

To prevent damage to the socket pins, do not remove the PnP cap unless you are installing a CPU.

3. Lift the load lever in the direction of the arrow to a 135° angle.

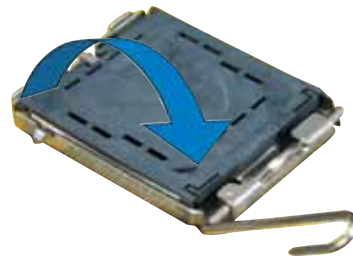

4. Lift the load plate with your thumb and forefinger to a 100° angle (A), then push the PnP cap from the load plate window to remove (B).

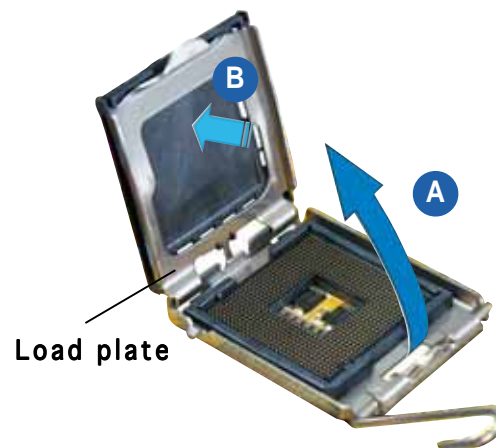

5. Position the CPU over the socket, making sure that the gold triangle is on the bottom-left corner of the socket. The socket alignment key should fit into the CPU notch.

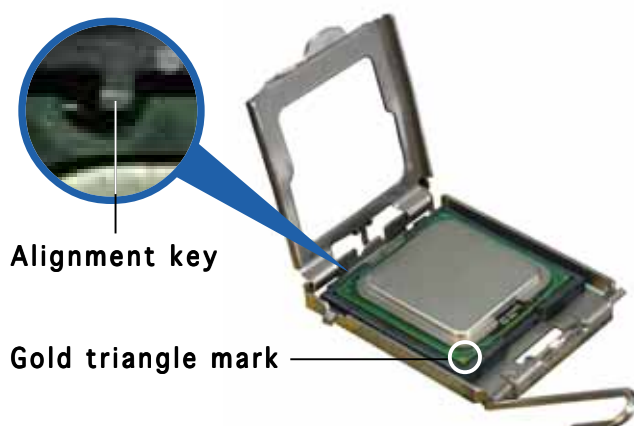

6. Close the load plate (A), then push the load lever (B) until it snaps into the retention tab.



The CPU fits in only one correct orientation. DO NOT force the CPU into the socket to prevent bending the connectors on the socket and damaging the CPU!

Notes on Intel® Hyper-Threading Technology



- This motherboard supports Intel® Pentium® 4 CPUs in the 775-land package with Hyper-Threading Technology.
- Hyper-Threading Technology is supported under Windows® XP/2003 Server and Linux 2.4.x (kernel) and later versions only. Under Linux, use the Hyper-Threading compiler to compile the code. If you are using any other operating systems, disable the Hyper-Threading Technology item in the BIOS to ensure system stability and performance.
- Installing Windows® 2003 Server or later version is recommended.
- Make sure to enable the Hyper-Threading Technology item in BIOS before installing a supported operating system.
- For more information on Hyper-Threading Technology, visit www.intel.com/info/hyperthreading.

To use the Hyper-Threading Technology on this motherboard:

1. Install an Intel® Pentium® 4 CPU that supports Hyper-Threading Technology.
2. Power up the system and enter the BIOS Setup (see Chapter 4: BIOS setup). Under the Advanced Menu, make sure that the item Hyper-Threading Technology is set to Enabled. The item appears only if you installed a CPU that supports Hyper-Threading Technology.
3. Reboot the computer.

2.3.2 Installing the CPU heatsink and fan

The Intel® Pentium® 4 LGA775 processor requires a specially designed heatsink and fan assembly to ensure optimum thermal condition and performance.



- When you buy a boxed Intel® Pentium® 4 processor, the package includes the CPU fan and heatsink assembly. If you buy a CPU separately, make sure that you use only Intel®-certified multi-directional heatsink and fan.
- Your Intel® Pentium® 4 LGA775 heatsink and fan assembly comes in a push-pin design and requires no tool to install.
- If you purchased a separate CPU heatsink and fan assembly, make sure that you have properly applied Thermal Interface Material to the CPU heatsink or CPU before you install the heatsink and fan assembly.



Make sure that you have installed the motherboard to the chassis before you install the CPU fan and heatsink assembly.

To install the CPU heatsink and fan:

1. Place the heatsink on top of the installed CPU, making sure that the four fasteners match the holes on the motherboard.



Orient the heatsink and fan assembly such that the CPU fan cable is closest to the CPU fan connector.

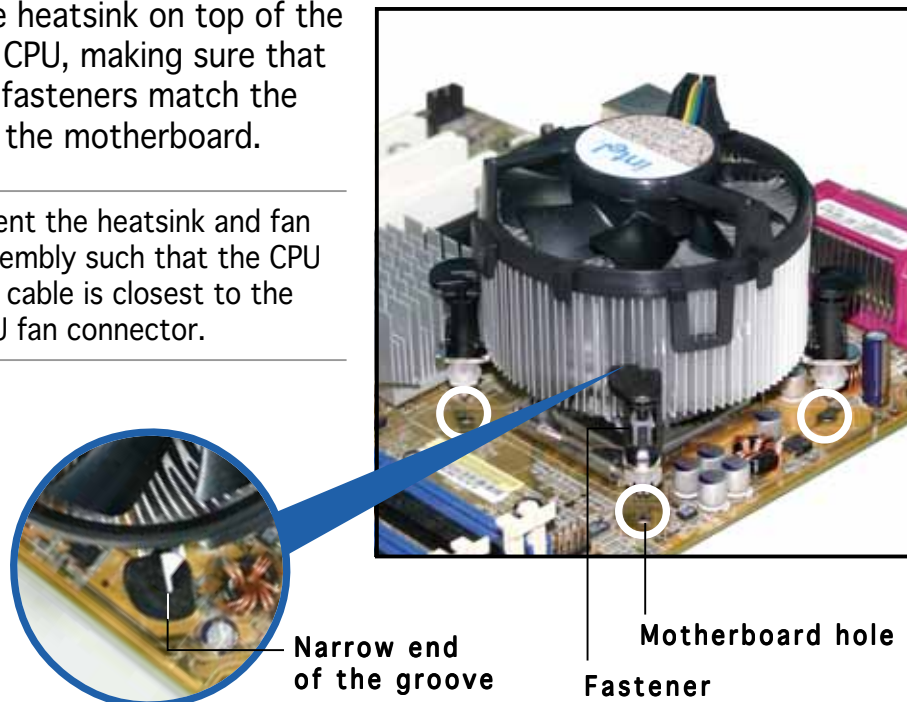

Make sure to orient each fastener with the narrow end of the groove pointing outward. (The photo shows the groove shaded for emphasis.)

2. Push down two fasteners at a time in a diagonal sequence to secure the heatsink and fan assembly in place.

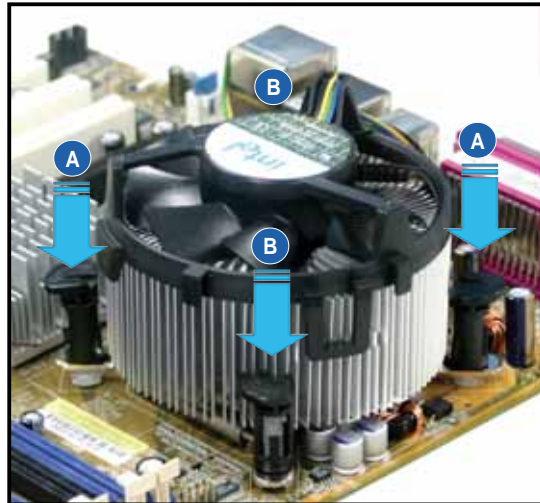
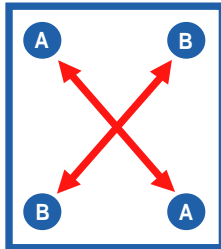

3. Connect the CPU fan cable to the connector on the motherboard labeled CPU_FAN1/CPU_FAN2.

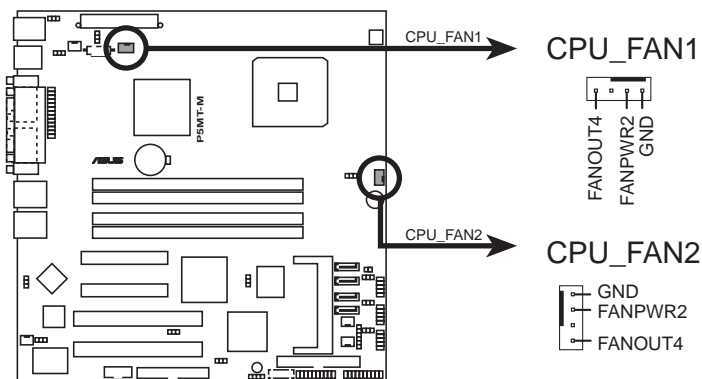

P5MT-M CPU fan connectors



- Do not forget to connect the CPU fan connector! Hardware monitoring errors can occur if you fail to plug this connector.
- If there is only one CPU fan cable, connect it to the connector labeled CPU_FAN1. Failure to do so may cause hardware monitoring errors.

2.3.3 Uninstalling the CPU heatsink and fan

To uninstall the CPU heatsink and fan:

1. Disconnect the CPU fan cable from the connector on the motherboard.
2. Rotate each fastener counterclockwise.



3. Pull up two fasteners at a time in a diagonal sequence to disengage the heatsink and fan assembly from the motherboard.

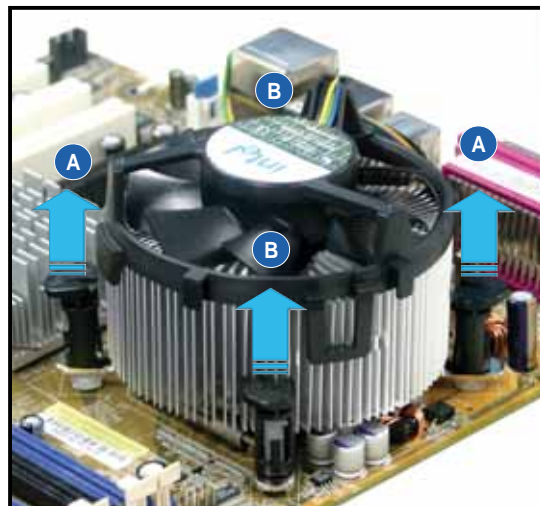
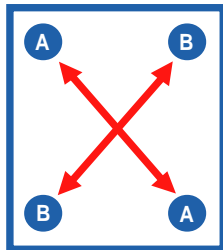

- Carefully remove the heatsink and fan assembly from the motherboard.



- Rotate each fastener clockwise to ensure correct orientation when reinstalling.

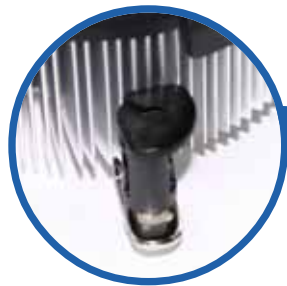

Narrow end of the groove



The narrow end of the groove should point outward after resetting. (The photo shows the groove shaded for emphasis.)



2.4 System memory

2.4.1 Overview

The motherboard comes with four Double Data Rate 2 (DDR2) Dual Inline Memory Modules (DIMM) sockets.

A DDR2 module has the same physical dimensions as a DDR DIMM but has a 240-pin footprint compared to the 184-pin DDR DIMM. DDR2 DIMMs are notched to match the break on the socket and ensure correct installation.

The figure illustrates the location of the DDR2 DIMM sockets:

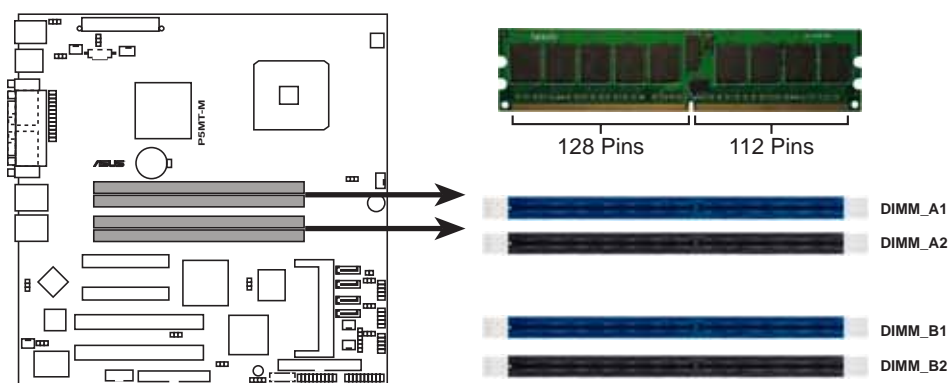

P5MT-M 240-pin DDR2 DIMM sockets

2.4.2 Memory configurations

You may install 256 MB, 512 MB and 1 GB unbuffered ECC/non-ECC DDR2 533/667 MHz DIMMs into the DIMM sockets.



Always install DIMMs with the same CAS latency. For optimum compatibility, it is recommended that you obtain memory modules from the same vendor.



Notes on capacity and installation of four 1 GB memory modules

- Due to chipset resource allocation, system configuration determines the system memory availability. The system typically shows about 3~4 GB available memory space due to chipset resource allocation for onboard devices and add-on cards. This will vary for different add-on cards that the user installs. Some PCI cards need larger memory space, which will make the total available memory space below 3 GB.
 - To prevent compatibility issues, do not combine single and double-sided memory modules on the same motherboard/system.
-

Recommended memory configurations

Mode	Sockets			
	DIMM_A1 (blue)	DIMM_A2 (black)	DIMM_B1 (blue)	DIMM_B2 (black)
Single-channel	(1) Installed	—	—	—
Dual-channel*	(1) Installed	—	Installed	—
	(2) Installed	Installed	Installed	Installed

* Use only identical DDR2 DIMM pairs.

Microsoft® OS memory support

Refer to the table below for the maximum memory support information on various Microsoft® operating systems.



The memory support information was gathered from various public Microsoft® web pages.

Microsoft® operating system	Maximum physical memory supported
Windows® 2000 Professional	4 GB
Windows® 2000 Server	4 GB
Windows® 2000 Advanced Server	8 GB
Windows® 2000 Datacenter Server	32 GB
Windows® XP Professional	4 GB
Windows® XP 64-bit Edition	32 GB
Windows® Server 2003 Web Edition	2 GB
Windows® Server 2003 Standard Edition	4 GB
Windows® Server 2003 Enterprise Edition	32 GB
Windows® Server 2003 Datacenter Edition	64 GB
Windows® Server 2003 Enterprise 64-bit Edition	64 GB
Windows® Server 2003 Datacenter 64-bit Edition	512 GB

2.4.3 Installing a DIMM



Unplug the power supply before adding or removing DIMMs or other system components. Failure to do so can cause severe damage to both the motherboard and the components.

To install a DIMM:

1. Unlock a DIMM socket by pressing the retaining clips outward.
2. Align a DIMM on the socket such that the notch on the DIMM matches the break on the socket.
3. Firmly insert the DIMM into the socket until the retaining clips snap back in place and the DIMM is properly seated.

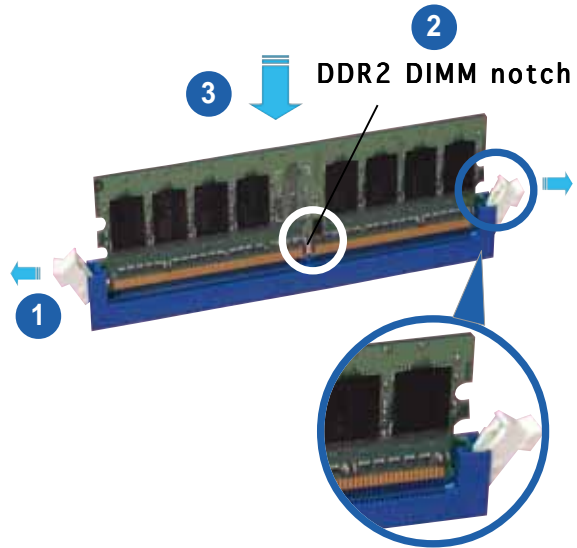

Unlocked retaining clip



- A DDR2 DIMM is keyed with a notch so that it fits in only one direction. Do not force a DIMM into a socket to avoid damaging the DIMM.
- The DDR2 DIMM sockets do not support DDR DIMMs. DO not install DDR DIMMs to the DDR2 DIMM sockets.

2.4.4 Removing a DIMM

To remove a DIMM:

1. Simultaneously press the retaining clips outward to unlock the DIMM.



Support the DIMM lightly with your fingers when pressing the retaining clips. The DIMM might get damaged when it flips out with extra force.

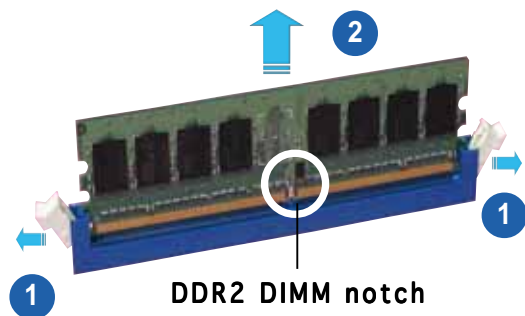

2. Remove the DIMM from the socket.

2.5 Expansion slots

In the future, you may need to install expansion cards. The following sub-sections describe the slots and the expansion cards that they support.



Make sure to unplug the power cord before adding or removing expansion cards. Failure to do so may cause you physical injury and damage motherboard components.

2.5.1 Installing an expansion card

To install an expansion card:

1. Before installing the expansion card, read the documentation that came with it and make the necessary hardware settings for the card.
2. Remove the system unit cover (if your motherboard is already installed in a chassis).
3. Remove the bracket opposite the slot that you intend to use. Keep the screw for later use.
4. Align the card connector with the slot and press firmly until the card is completely seated on the slot.
5. Secure the card to the chassis with the screw you removed earlier.
6. Replace the system cover.

2.5.2 Configuring an expansion card

After installing the expansion card, configure the it by adjusting the software settings.

1. Turn on the system and change the necessary BIOS settings, if any. See Chapter 4 for information on BIOS setup.
2. Assign an IRQ to the card. Refer to the tables on the next page.
3. Install the software drivers for the expansion card.



When using PCI cards on shared slots, ensure that the drivers support “Share IRQ” or that the cards do not need IRQ assignments. Otherwise, conflicts will arise between the two PCI groups, making the system unstable and the card inoperable.

2.5.3 Interrupt assignments

Standard interrupt assignments

IRQ	Priority	Standard Function
0	1	System Timer
1	2	Keyboard Controller
2	—	Re-direct to IRQ #9
3	11	Communications Port (COM2)*
4	12	Communications Port (COM1)*
5	13	IRQ holder for PCI steering*
6	14	Floppy Disk Controller
7	15	Printer Port (LPT1)*
8	3	System CMOS/Real Time Clock
9	4	IRQ holder for PCI steering*
10	5	IRQ holder for PCI steering*
11	6	IRQ holder for PCI steering*
12	7	PS/2 Compatible Mouse Port*
13	8	Numeric Data Processor
14	9	Primary IDE Channel
15	10	Secondary IDE Channel

* These IRQs are usually available for ISA or PCI devices.

IRQ assignments for this motherboard

	A	B	C	D	E	F	G	H
PCI slot 1	—	—	—	—	shared	—	—	—
PCI slot 2	—	—	—	—	—	—	shared	—
PCI E x8 slot	shared	—	—	—	—	—	—	—
PCI E x8 slot	shared	—	—	—	—	—	—	—
Onboard USB controller 1	shared	—	—	—	—	—	—	—
Onboard USB controller 2	—	shared	—	—	—	—	—	—
Onboard USB controller 3	—	—	used	—	—	—	—	—
Onboard USB controller 4	—	—	—	shared	—	—	—	—
Onboard USB 2.0 controller	shared	—	—	—	—	—	—	—
Onboard IDE port	shared	—	—	—	—	—	—	—
Onboard SATA port	—	shared	—	—	—	—	—	—
Onboard PCI E x1 LAN1	shared	—	—	—	—	—	—	—
Onboard PCI E x1 LAN2	—	shared	—	—	—	—	—	—
Onboard VGA	—	—	—	—	shared	—	—	—



When using PCI cards on shared slots, ensure that the drivers support “Share IRQ” or that the cards do not need IRQ assignments; otherwise, conflicts will arise between the two PCI groups, making the system unstable and the card inoperable.

2.5.4 PCI Express x8 slots

This motherboard supports PCI Express x8 network cards, SCSI cards, and other cards that comply with PCI Express 1.0 specifications.

PCI Express x8 slots

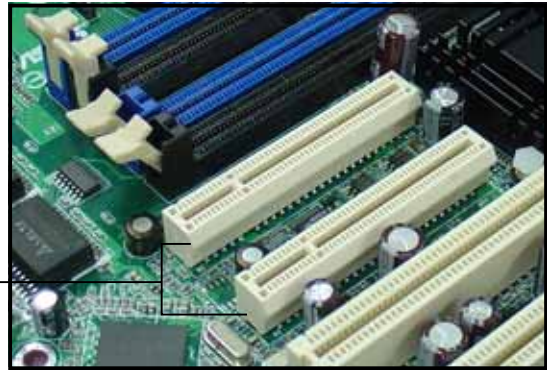

2.5.5 PCI slots

The PCI slots support cards such as a LAN card, SCSI card, USB card, and other cards that comply with PCI 2.3 specifications. The figure shows a LAN card installed on a PCI slot.

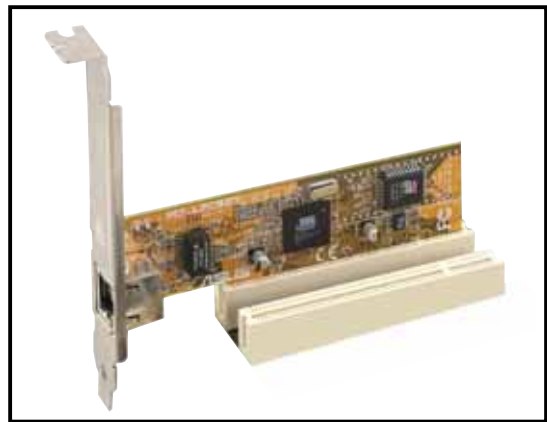

32-bit PCI slot

2.6 Jumpers

1. Clear RTC RAM (CLRTC1)

This jumper allows you to clear the Real Time Clock (RTC) RAM in CMOS. You can clear the CMOS memory of system setup parameters by erasing the CMOS RTC RAM data. The onboard button cell battery powers the RAM data in CMOS, which include system setup information such as system passwords.

To erase the RTC RAM:

1. Turn OFF the computer and unplug the power cord.
2. Remove the onboard battery.
3. Move the jumper cap from pins 1-2 (default) to pins 2-3. Keep the cap on pins 2-3 for about 5~10 seconds, then move the cap back to pins 1-2.
4. Re-install the battery.
5. Plug the power cord and turn ON the computer.
6. Hold down the key during the boot process and enter BIOS setup to re-enter data.



Except when clearing the RTC RAM, never remove the cap on CLRTC1 jumper default position. Removing the cap will cause system boot failure!

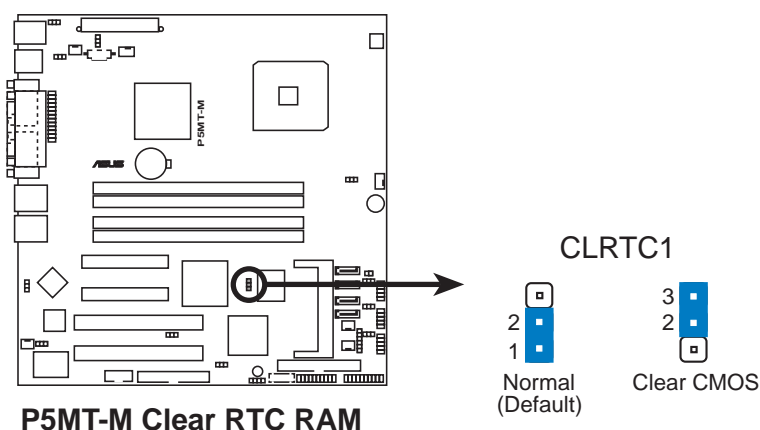

2. CPU fan pin selection (3-pin FM_CPU1, FM_CPU2)

These jumpers allow you to connect either a 3-pin or a 4-pin fan cable plug to the CPU fan connectors (CPU_FAN1, CPU_FAN2). Set these jumpers to pins 1-2 if you are using a 3-pin fan cable plug, or to pins 2-3 if you are using a 4-pin plug.

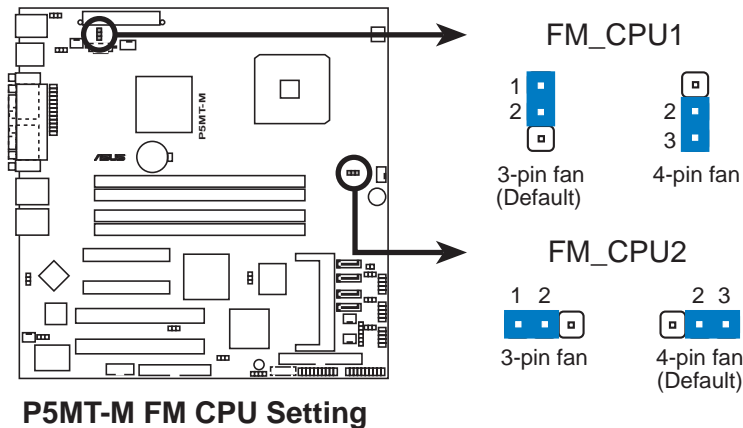

3. USB device wake-up (3-pin USBPW12, USBPW34, USBPW56, USBPW78)

Set these jumpers to +5V to wake up the computer from S1 sleep mode (CPU stopped, DRAM refreshed, system running in low power mode) using the connected USB devices. Set to +5VSB to wake up from S4 sleep mode (no power to CPU and DRAM, power supply in reduced power mode).

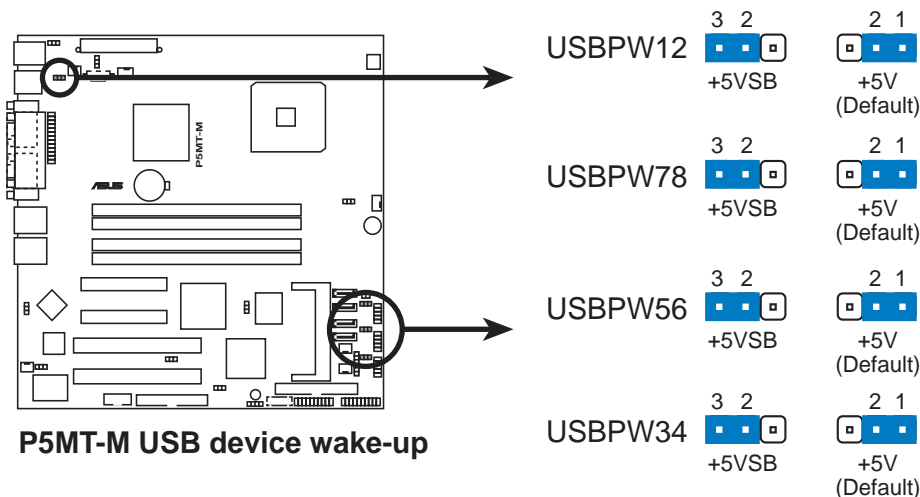

- The USB device wake-up feature requires a power supply that can provide 500mA on the +5VSB lead for each USB port; otherwise, the system would not power up.
- The total current consumed must NOT exceed the power supply capability (+5VSB) whether under normal condition or in sleep mode.

4. Keyboard power (3-pin KBPWR1)

This jumper allows you to enable or disable the keyboard wake-up feature. Set this jumper to pins 2-3 (+5VSB) to wake up the computer when you press a key on the keyboard (the default is the Space Bar). This feature requires an ATX power supply that can supply at least 1A on the +5VSB lead, and a corresponding setting in the BIOS.

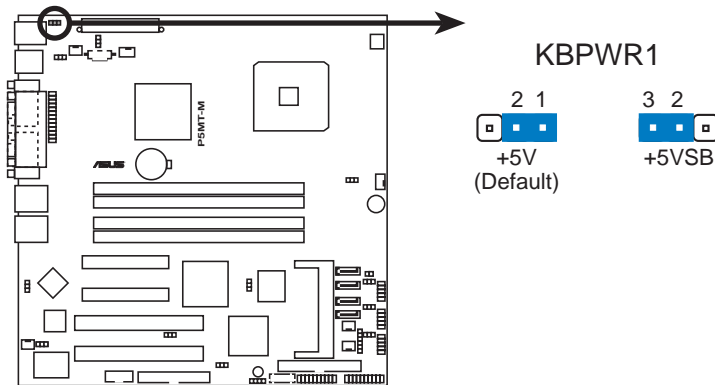

P5MT-M Keyboard power setting

5. Gigabit LAN controller setting (3-pin LAN_EN1)

These jumpers allow you to enable or disable the onboard Broadcom BCM5721 Gigabit LAN controller. Set to pins 1-2 to activate the Gigabit LAN feature.

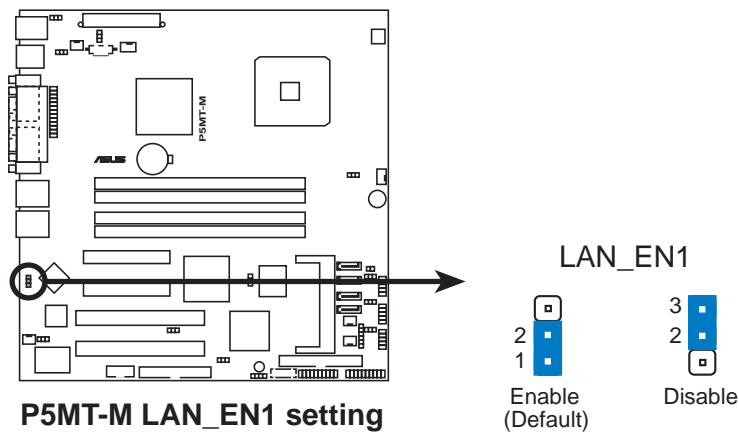

P5MT-M LAN_EN1 setting

6. Gigabit LAN controller setting (3-pin LAN_EN2)

These jumpers allow you to enable or disable the onboard Broadcom BCM5721 Gigabit LAN controller. Set to pins 1-2 to activate the Gigabit LAN feature.

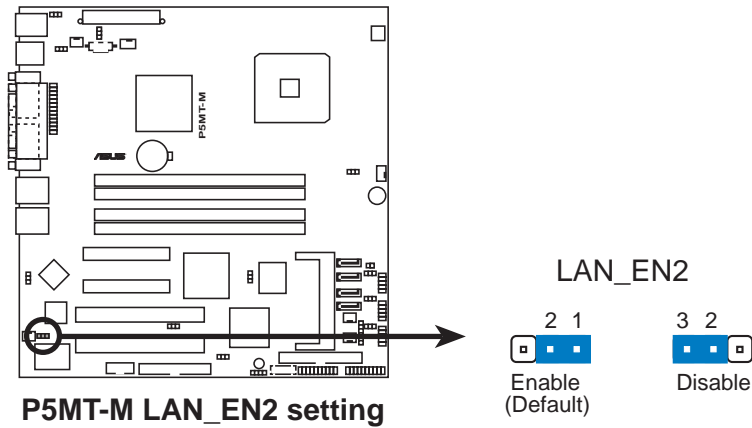

7. VGA graphics controller setting (3-pin VGA_EN1)

These jumpers allow you to enable or disable the onboard ATI Rage XL video graphics controller. Set to pins 1-2 to enable the video graphics controller.

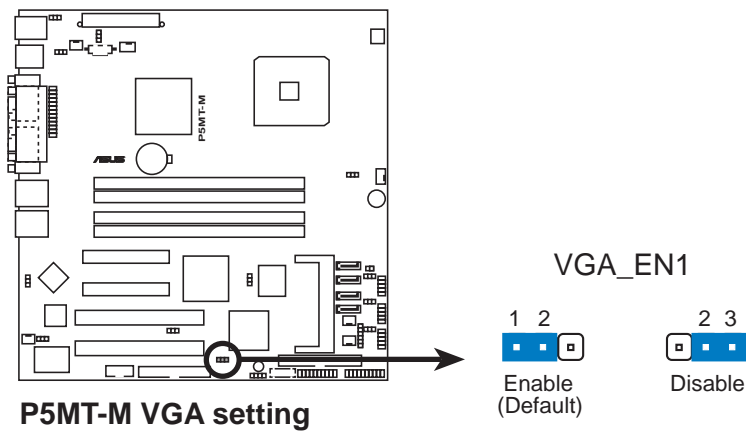

Make sure to set this jumper to **Disable** if you want to install VGA cards on the PCI and PCI Express slots.

8. BIOS recovery (3-pin RECOVERY1)

This jumper allows you to recover your original BIOS from a floppy disk in case the BIOS codes and data are corrupted.

To recover the BIOS:

1. Turn OFF your computer and unplug the power cord.
2. Move the jumper cap from pins 1-2 (default) to pins 2-3.
3. Insert a floppy disk with the original or updated BIOS file.
4. Plug the power cord and turn ON the computer.
5. The system searches for the BIOS file in the floppy then reflashes the BIOS.
6. When finished, shut down your computer.
7. Replace the jumper cap from pins 2-3 to pins 1-2.
8. Reboot your computer.
9. Hold down the **** key during the boot process and enter BIOS setup to re-enter data.

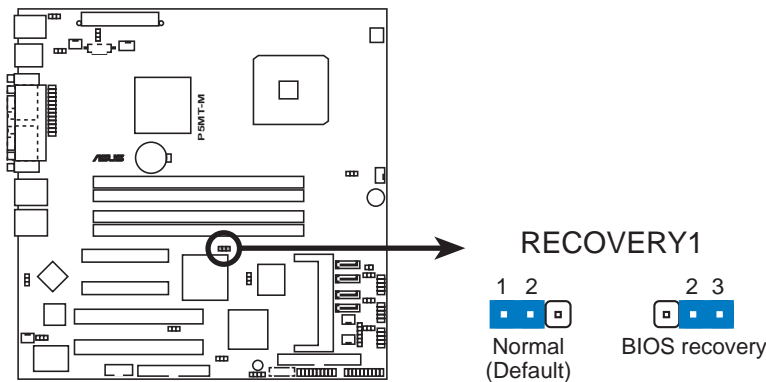

P5MT-M BIOS recovery setting

9. RAID select setting (3-pin RAID_SEL1)

Set this jumper to 1-2 (Default) to enable LSI RAID ROM. Set this jumper to 2-3 to enable Intel® RAID ROM.

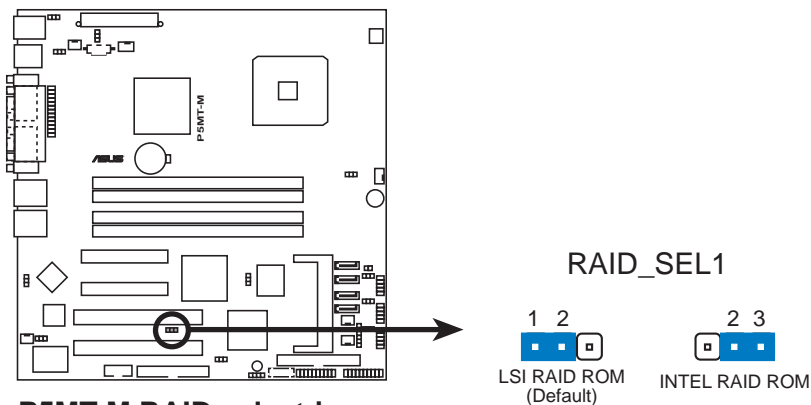

P5MT-M RAID select jumper

2.7 Connectors

2.7.1 Rear panel connectors

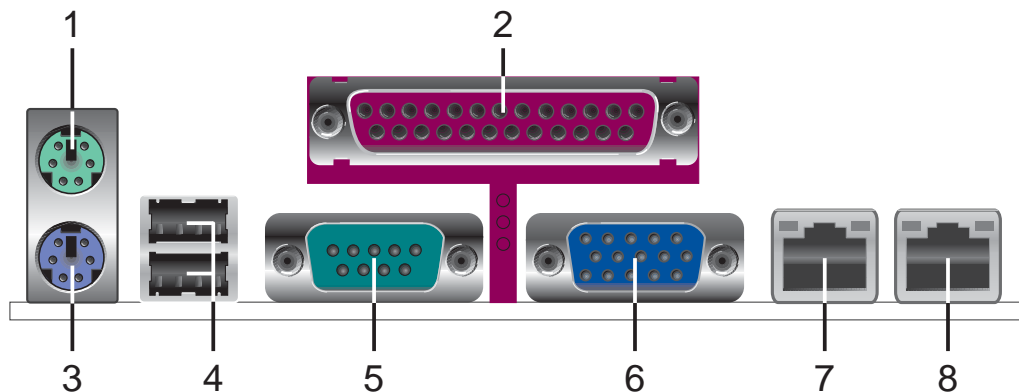

1. **PS/2 mouse port (green).** This port is for a PS/2 mouse.
2. **Parallel port.** This 25-pin port connects a parallel printer, a scanner, or other devices.
3. **PS/2 keyboard port (purple).** This port is for a PS/2 keyboard.
4. **USB 2.0 ports 1 and 2.** These two 4-pin Universal Serial Bus (USB) ports are available for connecting USB 2.0 devices.
5. **Serial (COM1) port.** This 9-pin communication port is for pointing devices or other serial devices.
6. **Video Graphics Adapter (VGA) port.** This port is for a VGA monitor or other VGA-compatible devices.
7. **LAN 1 (RJ-45) port.** This port allows Gigabit connection to a Local Area Network (LAN) through a network hub. Refer to the table below for the LAN port LED indications.
8. **LAN 2 (RJ-45) port.** This port allows Gigabit connection to a Local Area Network (LAN) through a network hub. Refer to the table below for the LAN port LED indications.

LAN port LED indications

ACT/LINK LED		SPEED LED	
Status	Description	Status	Description
OFF	No link	OFF	10 Mbps connection
GREEN	Linked	ORANGE	100 Mbps connection
BLINKING	Data activity	GREEN	1 Gbps connection

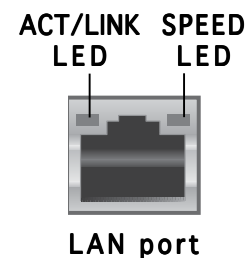

2.7.2 Internal connectors

1. Floppy disk drive connector (34-1 pin FLOPPY1)

This connector is for the provided floppy disk drive (FDD) signal cable. Insert one end of the cable to this connector, then connect the other end to the signal connector at the back of the floppy disk drive.



Pin 5 on the connector is removed to prevent incorrect cable connection when using a FDD cable with a covered Pin 5.

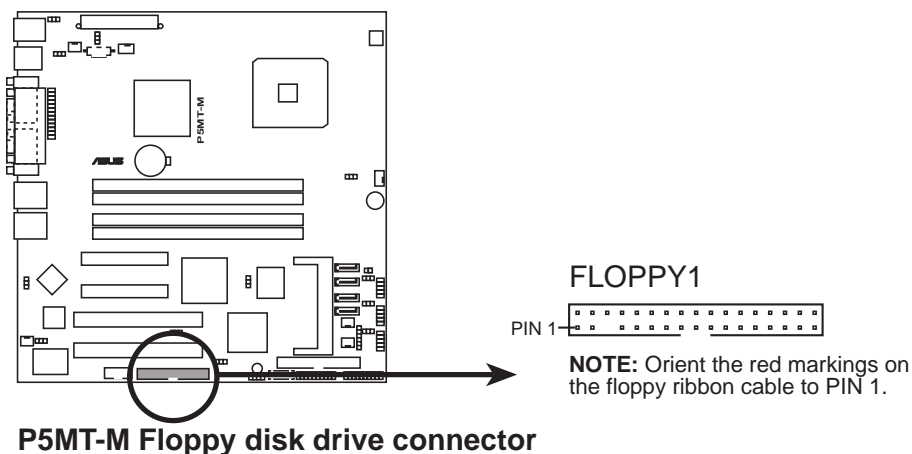

2. Hard disk activity LED connector (4-pin HDLED1)

This connector supplies power to the hard disk activity LED for add-on cards such as SCSI or RAID cards. The read/write activities of the add-on cards cause the hard disk activity LED to light up.

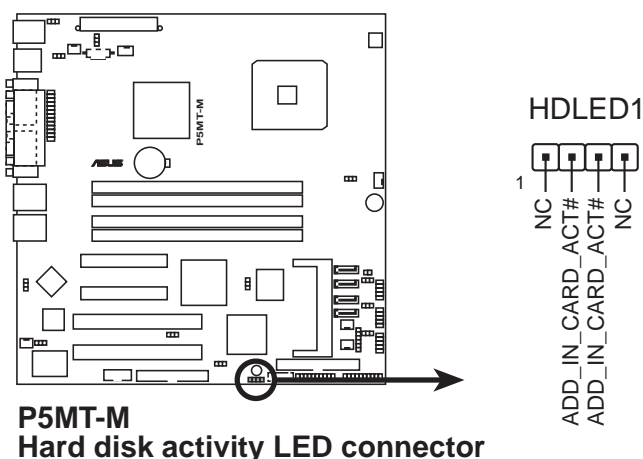

3. IDE connector (40-1 pin PRI_IDE1)

This connector is for an Ultra DMA 100/66 signal cable. The Ultra DMA 100/66 signal cable has three connectors: a blue connector for the primary IDE connector on the motherboard, a black connector for an Ultra DMA 100/66 IDE slave device (optical drive/hard disk drive), and a gray connector for an Ultra DMA 100/66 IDE master device (hard disk drive). If you install two hard disk drives, you must configure the second drive as a slave device by setting its jumper accordingly. Refer to the hard disk documentation for the jumper settings.



- Pin 20 on the IDE connector is removed to match the covered hole on the Ultra DMA cable connector. This prevents incorrect insertion when you connect the IDE cable.
- Use the 80-conductor IDE cable for Ultra DMA 100/66 IDE devices.

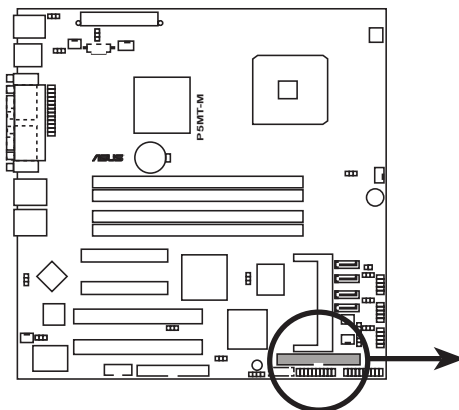

P5MT-M IDE connector



NOTE: Orient the red markings (usually zigzag) on the IDE ribbon cable to PIN 1.

4. Serial ATA connectors (7-pin SATA1, SATA2, SATA3, SATA4)

These connectors are for the Serial ATA signal cables for Serial ATA hard disk drives.

If you installed Serial ATA hard disk drives, you can create a RAID 0, RAID 1, RAID 5, or RAID 10 configuration with the onboard Intel® ICH7R RAID controller.



These connectors are set to **Standard IDE** mode by default. In **Standard IDE** mode, you can connect Serial ATA boot/data hard disk drives to these connectors. If you intend to create a Serial ATA RAID set using these connectors, set the **Configure SATA as** item in the BIOS to [RAID]. See section “4.3.5 IDE Configuration” for details.

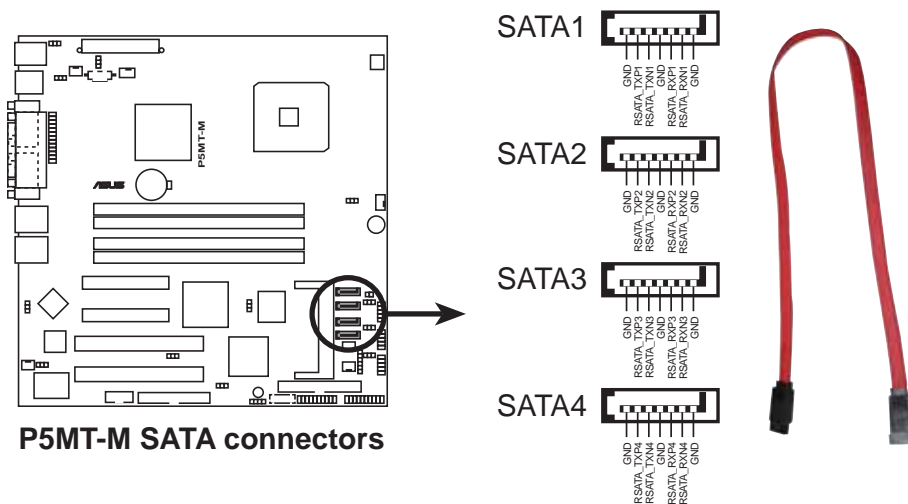

When using the connectors in **Standard IDE** mode, connect the primary (boot) hard disk drive to the SATA1 or SATA2 connector. Refer to the table below for the recommended SATA hard disk drive connections.

Serial ATA hard disk drive connection

Connector	Setting	Use
SATA1, SATA2	Master	Boot disk
SATA3, SATA4	Slave	Data disk

5. CPU and system fan connectors (4-pin CPU_FAN1/2, 3-pin REAR_FAN1/2, 3-pin FRNT_FAN1/2)

The fan connectors support cooling fans of 350 mA ~ 740 mA (8.88 W max.) or a total of 2.1 A ~ 4.44 A (53.28 W max.) at +12V. Connect the fan cables to the fan connectors on the motherboard, making sure that the black wire of each cable matches the ground pin of the connector.



Do not forget to connect the fan cables to the fan connectors. Insufficient air flow inside the system may damage the motherboard components. These are not jumpers! Do not place jumper caps on the fan connectors!

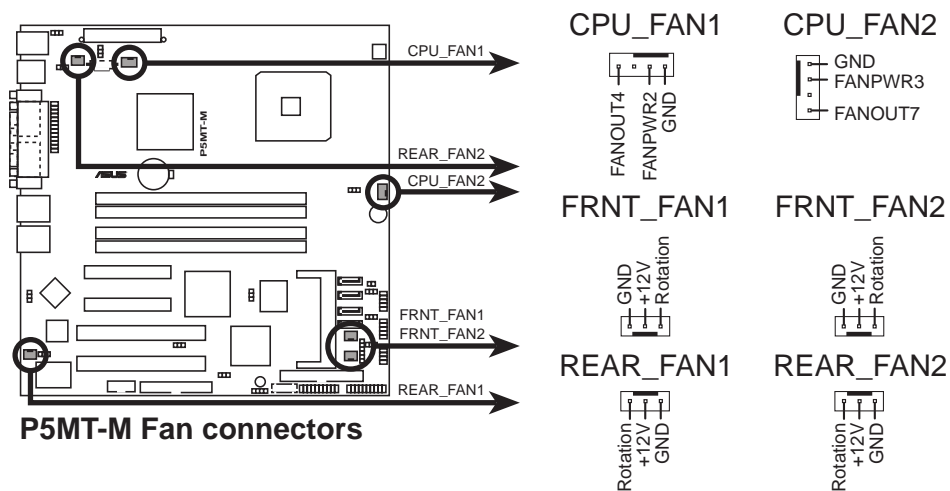

6. Serial port connector (10-1 pin COM2)

This connector is for a serial (COM2) port. Connect the serial port module cable to this connector, then install the module to a slot opening at the back of the system chassis.

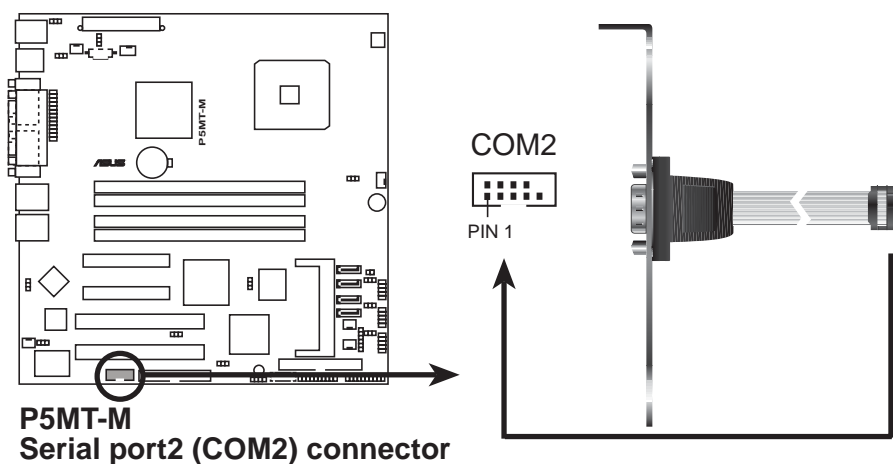

7. USB connector (10-1 pin USB34, USB56, USB78)

This connector is for USB 2.0 ports. Connect the USB module cable to this connector, then install the module to a slot opening at the back of the system chassis. The USB connector complies with USB 2.0 specification that supports up to 480 Mbps connection speed.

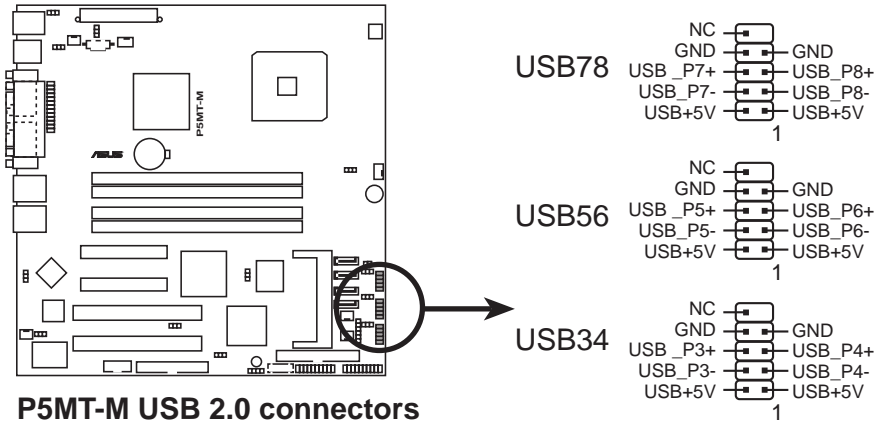

Never connect a **1394 cable** to the USB connectors. Doing so will damage the motherboard!

8. Parallel port connector (26-1 pin LPT2)

This connector is a parallel port module that connects a parallel printer, a scanner, or other devices.

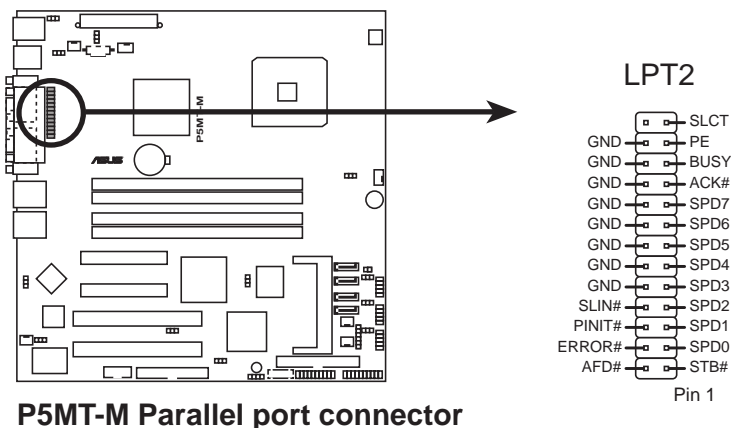

9. SSI power connectors (24-pin ATXPWR1, 4-pin ATX12V1)

These connectors are for SSI power supply plugs. The power supply plugs are designed to fit these connectors in only one orientation. Find the proper orientation and push down firmly until the connectors completely fit.



- Use of an SSI 12 V Specification 2.0-compliant power supply unit (PSU) that provides a minimum power of 450 W is recommended for a fully-configured system.
- Do not forget to connect the 4-pin ATX12V1 power plug; otherwise, the system will not boot up.
- Use of a PSU with a higher power output is recommended when configuring a system with more power consuming devices. The system may become unstable or may not boot up if the power is inadequate.
- You must install a PSU with a higher power rating if you intend to install additional devices.

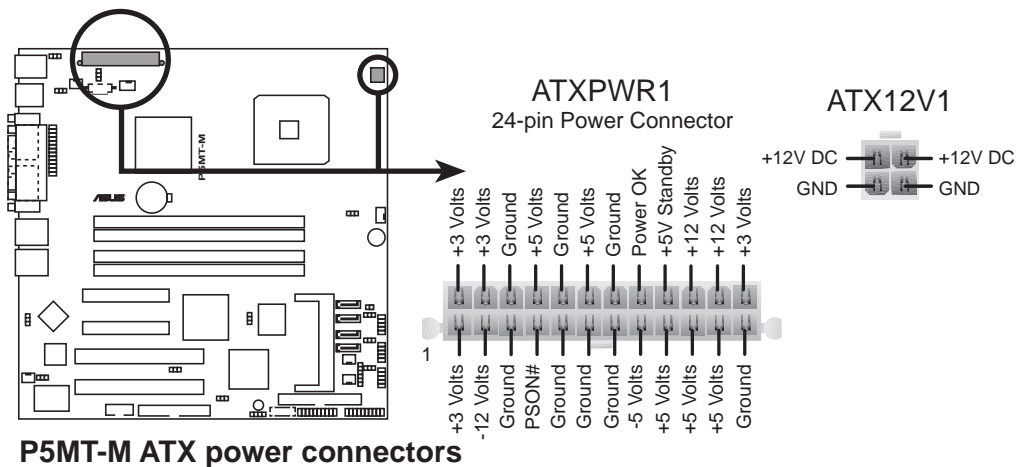

10. Backplane SMBus connector (6-1 pin BPSMB1)

This connector allows you to connect SMBus (System Management Bus) devices. Devices communicate with an SMBus host and/or other SMBus devices using the SMBus interface.

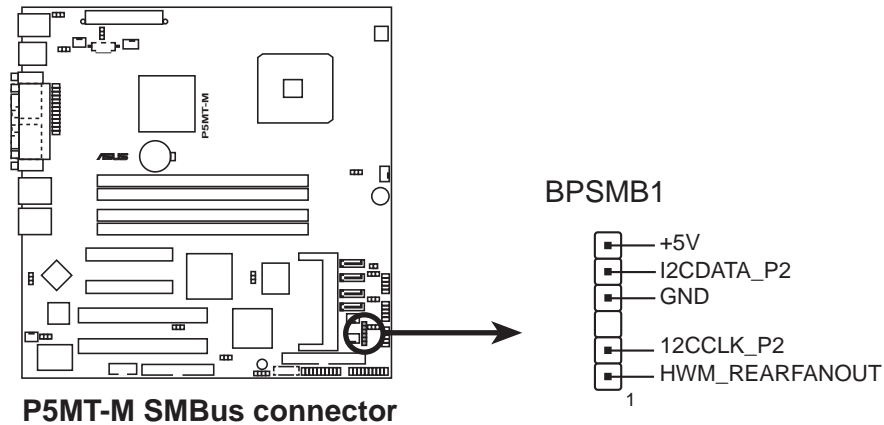

11. Power supply SMBus connector (6-1 pin PSUSMB1)

This connector allows you to connect SMBus (System Management Bus) devices. Devices communicate with an SMBus host and/or other SMBus devices using the SMBus interface.

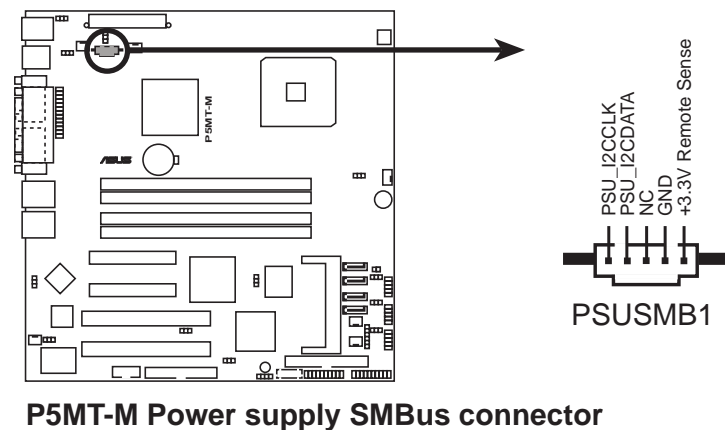

12. BMC connector (16-pin BMCCONN1)

This connector is for an ASUS server management card.

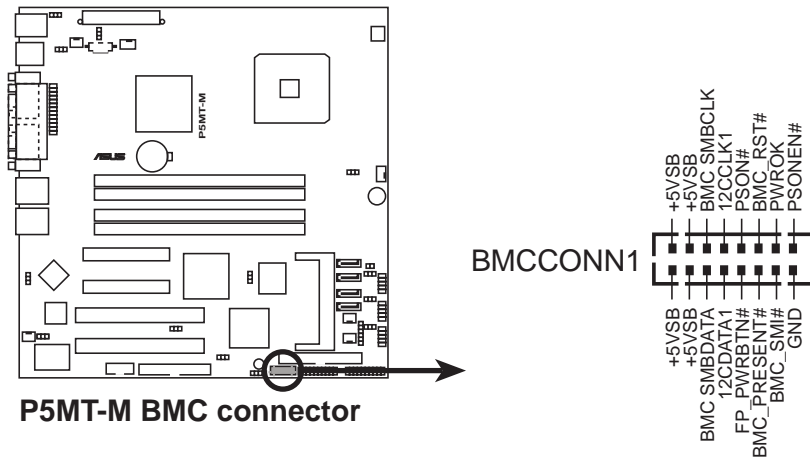

13. Ambient thermal sensor connector (2-pin TRPWR1)

If you want additional thermal monitoring, connect the thermal sensor cable with a thermistor (of 1°K or at 25°C, B=3435) to this connector.

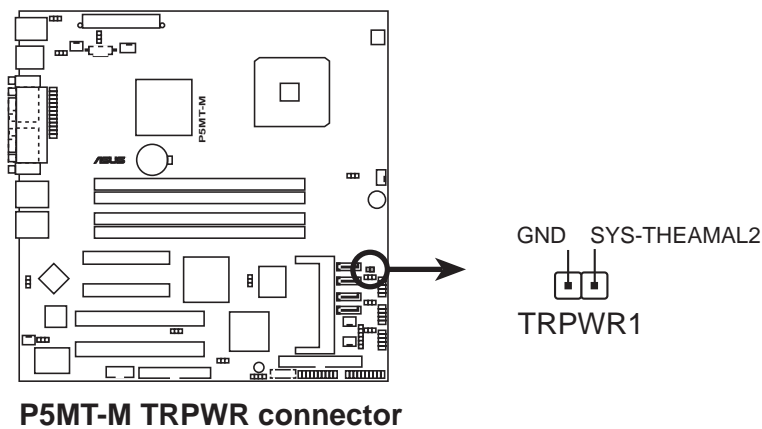

14. Auxiliary panel connector (20-pin AUX_PANEL1)

This connector supports several server system functions.

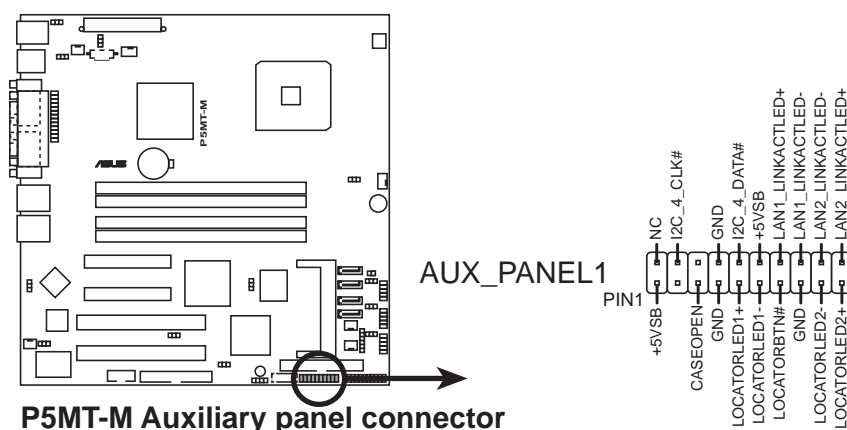

P5MT-M Auxiliary panel connector

- **Chassis Intrusion connector (3-pin CASEOPEN)**
This lead is for a chassis with an intrusion detection feature. This requires an external detection mechanism such as a chassis intrusion sensor or microswitch. When you remove any chassis component, the sensor triggers and sends a high-level signal to this lead to record a chassis intrusion event.
- **LAN1 link activity LED (2-pin LAN1_LINKACTLED)**
This 2-pin connector is for the LAN1 Activity LED. Connect the LAN1 Activity LED cable to this connector. This LED blinks during a network activity and is always lit when linked.
- **LAN2 link activity LED (2-pin LAN2_LINKACTLED)**
This 2-pin connector is for the LAN2 Activity LED. Connect the LAN2 Activity LED cable to this connector. This LED blinks during a network activity and lights up when linked.
- **Locator LED 1 (2-pin LOCATORLED1)**
This 2-pin connector is for the Locator LED 1. Connect the Locator LED 1 cable to this connector. This LED lights up when the Locator button is pressed and if there is no LAN1 connection (e.g. the LAN1 controller is broken).
- **Locator LED 2 (2-pin LOCATORLED2)**
This 2-pin connector is for the Locator LED 2. Connect the Locator LED 2 cable to this connector. This LED is synchronized with the LAN2 LED.
- **Locator Button/Switch (2-pin LOCATORBTN)**
This connector is for the locator button. This button queries the state of the system locator.
- **Front Panel SMBus (6-1 pin)**
This connector allows you to connect SMBus (System Management Bus) devices. Devices communicate with an SMBus host and/or other SMBus devices using the SMBus interface.

15. System panel connector (20-pin PANEL1)

This connector supports several chassis-mounted functions.

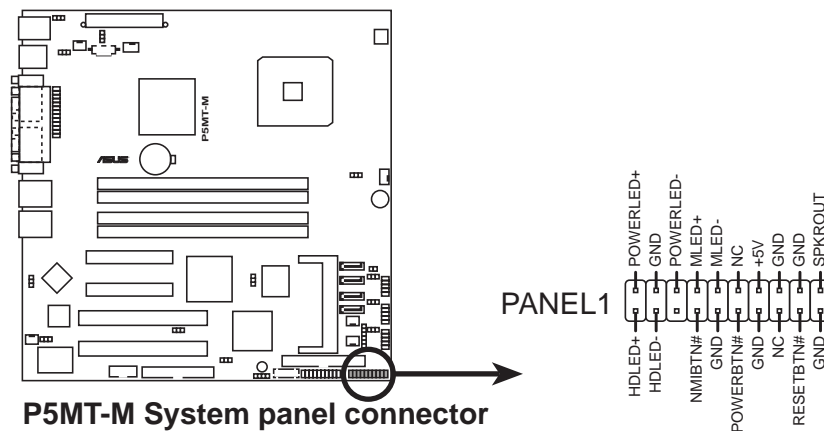

The system panel connector is color-coded for easy connection.

- **System power LED (Green 3-pin POWERLED)**
This 3-pin connector is for the system power LED. Connect the chassis power LED cable to this connector. The system power LED lights up when you turn on the system power, and blinks when the system is in sleep mode.
- **Hard disk drive activity LED (Red 2-pin HDLED)**
This 2-pin connector is for the HDD Activity LED. Connect the HDD Activity LED cable to this connector. The IDE LED lights up or flashes when data is read from or written to the HDD.
- **System warning speaker (Orange 4-pin SPKRROUT)**
This 4-pin connector is for the chassis-mounted system warning speaker. The speaker allows you to hear system beeps and warnings.
- **ATX power button/soft-off button (Yellow 2-pin POWERBTN)**
This connector is for the system power button. Pressing the power button turns the system on or puts the system in sleep or soft-off mode depending on the BIOS settings. Pressing the power switch for more than four seconds while the system is ON turns the system OFF.
- **Reset button (Blue 2-pin RESETBTN)**
This 2-pin connector is for the chassis-mounted reset button for system reboot without turning off the system power.

This chapter describes the power up sequence, the vocal POST messages, and ways of shutting down the system.

Powering up

Chapter summary

3

3.1	Starting up for the first time	3-1
3.2	Turning off the computer	3-2

3.1 Starting up for the first time

1. After making all the connections, replace the system case cover.
2. Be sure that all switches are off.
3. Connect the power cord to the power connector at the back of the system chassis.
4. Connect the power cord to a power outlet that is equipped with a surge protector.
5. Turn on the devices in the following order:
 - a. Monitor
 - b. External SCSI devices (starting with the last device on the chain)
 - c. System power
6. After applying power, the system power LED on the system front panel case lights up. For systems with ATX power supplies, the system LED lights up when you press the ATX power button. If your monitor complies with “green” standards or if it has a “power standby” feature, the monitor LED may light up or switch between orange and green after the system LED turns on.

The system then runs the power-on self tests or POST. While the tests are running, the BIOS beeps (see BIOS beep codes table below) or additional messages appear on the screen. If you do not see anything within 30 seconds from the time you turned on the power, the system may have failed a power-on test. Check the jumper settings and connections or call your retailer for assistance.

AMI BIOS beep codes

Beep Description	Error
One beep	Keyboard controller error Refresh Time error No master drive detected
Two continuous beeps followed by two short beeps	Floppy controller failure
Two continuous beeps followed by four short beeps	Hardware component failure

7. At power on, hold down the <Delete> key to enter the BIOS Setup. Follow the instructions in Chapter 4.

3.2 Turning off the computer

3.2.1 Using the OS shut down function

If you are using Windows® Server 2000:

1. Click the **Start** button then click **Shut Down...**
2. Make sure that the **Shut Down** option button is selected, then click the **OK** button to shut down the computer.
3. The power supply should turn off after Windows® shuts down.

If you are using Windows® Server 2003:

1. Click the **Start** button then select **Turn Off Computer.**
2. Click the **Turn Off** button to shut down the computer.
3. The power supply should turn off after Windows® shuts down.

3.2.2 Using the dual function power switch

While the system is ON, pressing the power switch for less than four seconds puts the system to sleep mode or to soft-off mode, depending on the BIOS setting. Pressing the power switch for more than four seconds lets the system enter the soft-off mode regardless of the BIOS setting. Refer to section “4.5 Power Menu” in Chapter 4 for details.

This chapter tells how to change the system settings through the BIOS Setup menus. Detailed descriptions of the BIOS parameters are also provided.

BIOS setup

4.1	Managing and updating your BIOS	4-1
4.2	BIOS setup program	4-11
4.3	Main menu	4-14
4.4	Advanced menu	4-19
4.5	Power menu	4-27
4.6	Boot menu	4-31
4.7	Exit menu	4-35

4.1 Managing and updating your BIOS

The following utilities allow you to manage and update the motherboard Basic Input/Output System (BIOS) setup.

1. **ASUS AFUDOS** (Updates the BIOS in DOS mode using a bootable floppy disk.)
2. **ASUS EZ Flash** (Updates the BIOS using a floppy disk during POST.)
3. **ASUS CrashFree BIOS 2** (Updates the BIOS using a bootable floppy disk or the motherboard support CD when the BIOS file fails or gets corrupted.)
4. **ASUS Update** (Updates the BIOS in Windows® environment.)

Refer to the corresponding sections for details on these utilities.



Save a copy of the original motherboard BIOS file to a bootable floppy disk in case you need to restore the BIOS in the future. Copy the original motherboard BIOS using the ASUS Update or AFUDOS utilities.

4.1.1 Creating a bootable floppy disk

1. Do either one of the following to create a bootable floppy disk.

DOS environment

- a. Insert a 1.44 MB floppy disk into the drive.
- b. At the DOS prompt, type **format A:/S** then press <Enter>.

Windows® XP environment

- a. Insert a 1.44 MB floppy disk to the floppy disk drive.
- b. Click **Start** from the Windows® desktop, then select **My Computer**.
- c. Select the 3 1/2 Floppy Drive icon.
- d. Click **File** from the menu, then select **Format**. A **Format 3 1/2 Floppy Disk** window appears.
- e. **Windows® XP users:** Select **Create an MS-DOS startup disk** from the format options field, then click **Start**.

Windows® 2000 environment

To create a set of boot disks for Windows® 2000:

- a. Insert a formatted, high density 1.44 MB floppy disk into the drive.
 - b. Insert the Windows® 2000 CD to the optical drive.
 - c. Click **Start**, then select **Run**.
 - d. In the **Open** field, type `D:\bootdisk\makeboot a:` assuming that D is your optical drive letter.
 - e. Press <Enter>, then follow screen instructions to continue.
2. Copy the original or the latest motherboard BIOS file to the bootable floppy disk.

4.1.2 ASUS EZ Flash utility

The ASUS EZ Flash feature allows you to update the BIOS without having to go through the long process of booting from a floppy disk and using a DOS-based utility. The EZ Flash utility is built-in the BIOS chip so it is accessible by pressing <Alt> + <F2> during the Power-On Self Tests (POST).

To update the BIOS using EZ Flash:

1. Visit the ASUS website (www.asus.com) to download the latest BIOS file for the motherboard and rename the same to **P5MT-M.ROM**.
2. Save the BIOS file to a floppy disk, then restart the system.
3. Press <Alt> + <F2> during POST to display the following.

```
EZFlash starting BIOS update
Checking for floppy...
```

4. Insert the floppy disk that contains the BIOS file to the floppy disk drive. When the correct BIOS file is found, EZ Flash performs the BIOS update process and automatically reboots the system when done.

```
EZFlash starting BIOS update
Checking for floppy...
Floppy found!
Reading file "P5MT-M.ROM". Completed.
Start erasing.....|
Start programming...|
Flashed successfully. Rebooting.
```



- Do not shut down or reset the system while updating the BIOS to prevent system boot failure!
- A “Floppy not found!” error message appears if there is no floppy disk in the drive. A “P5MT-M.ROM not found!” error message appears if the correct BIOS file is not found in the floppy disk. Make sure that you rename the BIOS file to P5MT-M.ROM.

4.1.3 AFUDOS utility

The AFUDOS utility allows you to update the BIOS file in DOS environment using a bootable floppy disk with the updated BIOS file. This utility also allows you to copy the current BIOS file that you can use as backup when the BIOS fails or gets corrupted during the updating process.

Copying the current BIOS

To copy the current BIOS file using the AFUDOS utility:



- Make sure that the floppy disk is not write-protected and has at least 1024 KB free space to save the file.
- The succeeding BIOS screens are for reference only. The actual BIOS screen displays may not be same as shown.

1. Copy the AFUDOS utility (afudos.exe) from the motherboard support CD to the bootable floppy disk you created earlier.
2. Boot the system in DOS mode, then at the prompt type:

```
afudos /o[filename]
```

where the [filename] is any user-assigned filename not more than eight alphanumeric characters for the main filename and three alphanumeric characters for the extension name.

```
A:\>afudos /oOLDBIOS1.rom
```

Main filename Extension name

3. Press <Enter>. The utility copies the current BIOS file to the floppy disk.

```
A:\>afudos /oOLDBIOS1.rom
AMI Firmware Update Utility - Version 1.19(ASUS V2.07(03.11.24BB))
Copyright (C) 2002 American Megatrends, Inc. All rights reserved.
  Reading flash ..... done
  Write to file..... ok
A:\>
```

The utility returns to the DOS prompt after copying the current BIOS file.

Updating the BIOS file

To update the BIOS file using the AFUDOS utility:

1. Visit the ASUS website (www.asus.com) and download the latest BIOS file for the motherboard. Save the BIOS file to a bootable floppy disk.



Write the BIOS filename on a piece of paper. You need to type the exact BIOS filename at the DOS prompt.

2. Copy the AFUDOS utility (afudos.exe) from the motherboard support CD to the bootable floppy disk you created earlier.
3. Boot the system in DOS mode, then at the prompt type:

```
afudos /i[filename] /pbnc
```

where [filename] is the latest or the original BIOS file on the bootable floppy disk.

```
A:\>afudos /iP5MT-M.ROM /pbnc
```

4. The utility verifies the file and starts updating the BIOS.

```
A:\>afudos /iP5MT-M.ROM /pbnc
AMI Firmware Update Utility - Version 1.19 (ASUS V2.07(03.11.24BB))
Copyright (C) 2002 American Megatrends, Inc. All rights reserved.

WARNING!! Do not turn off power during flash BIOS
Reading file ..... done
Reading flash ..... done

Advance Check .....
Erasing flash ..... done
Writing flash ..... 0x0008CC00 (9%)
```



Do not shut down or reset the system while updating the BIOS to prevent system boot failure!

5. The utility returns to the DOS prompt after the BIOS update process is completed. Reboot the system from the hard disk drive.

```
A:\>afudos /iP5MT-M.ROM /pbnc
AMI Firmware Update Utility - Version 1.19 (ASUS V2.07(03.11.24BB))
Copyright (C) 2002 American Megatrends, Inc. All rights reserved.

WARNING!! Do not turn off power during flash BIOS
Reading file ..... done
Reading flash ..... done

Advance Check .....
Erasing flash ..... done
Writing flash ..... done
Verifying flash .... done

Please restart your computer

A:\>
```

4.1.4 ASUS CrashFree BIOS 2 utility

The ASUS CrashFree BIOS 2 is an auto recovery tool that allows you to restore the BIOS file when it fails or gets corrupted during the updating process. You can update a corrupted BIOS file using the motherboard support CD or the floppy disk that contains the updated BIOS file.



- Prepare the motherboard support CD or the floppy disk containing the updated motherboard BIOS before using this utility.
- Make sure that you rename the original or updated BIOS file in the floppy disk to **P5MT-M.ROM**.

Recovering the BIOS from a floppy disk

To recover the BIOS from a floppy disk:

1. Turn on the system.
2. Insert the floppy disk with the original or updated BIOS file to the floppy disk drive.
3. The utility displays the following message and automatically checks the floppy disk for the original or updated BIOS file.

```
Bad BIOS checksum. Starting BIOS recovery...
Checking for floppy...
```

When found, the utility reads the BIOS file and starts flashing the corrupted BIOS file.

```
Bad BIOS checksum. Starting BIOS recovery...
Checking for floppy...
Floppy found!
Reading file "P5MT-M.ROM". Completed.
Start flashing...
```



DO NOT shut down or reset the system while updating the BIOS! Doing so can cause system boot failure!

4. Restart the system after the utility completes the updating process.

Recovering the BIOS from the support CD

To recover the BIOS from the support CD:

1. Remove any floppy disk from the floppy disk drive, then turn on the system.
2. Insert the support CD to the optical drive.
3. The utility displays the following message and automatically checks the floppy disk for the original or updated BIOS file.

```
Bad BIOS checksum. Starting BIOS recovery...  
Checking for floppy...
```

When no floppy disk is found, the utility automatically checks the optical drive for the original or updated BIOS file. The utility then updates the corrupted BIOS file.

```
Bad BIOS checksum. Starting BIOS recovery...  
Checking for floppy...  
Floppy not found!  
Checking for CD-ROM...  
CD-ROM found!  
Reading file "P5MT-M.ROM". Completed.  
Start flashing...
```



DO NOT shut down or reset the system while updating the BIOS! Doing so can cause system boot failure!

4. Restart the system after the utility completes the updating process.



The recovered BIOS may not be the latest BIOS version for this motherboard. Visit the ASUS website (www.asus.com) to download the latest BIOS file.

4.1.5 ASUS Update utility

The ASUS Update is a utility that allows you to manage, save, and update the motherboard BIOS in Windows® environment. The ASUS Update utility allows you to:

- Save the current BIOS file
- Download the latest BIOS file from the Internet
- Update the BIOS from an updated BIOS file
- Update the BIOS directly from the Internet, and
- View the BIOS version information.

This utility is available in the support CD that comes with the motherboard package.



ASUS Update requires an Internet connection either through a network or an Internet Service Provider (ISP).

Installing ASUS Update

To install ASUS Update:

1. Place the support CD in the optical drive. The **Drivers** menu appears.
2. Click the **Utilities** tab, then click **Install ASUS Update VX.XX.XX**.
3. The ASUS Update utility is copied to your system.



Quit all Windows® applications before you update the BIOS using this utility.

Updating the BIOS through the Internet

To update the BIOS through the Internet:

1. Launch the ASUS Update utility from the Windows® desktop by clicking **Start > Programs > ASUS > ASUSUpdate > ASUSUpdate**. The ASUS Update main window appears.

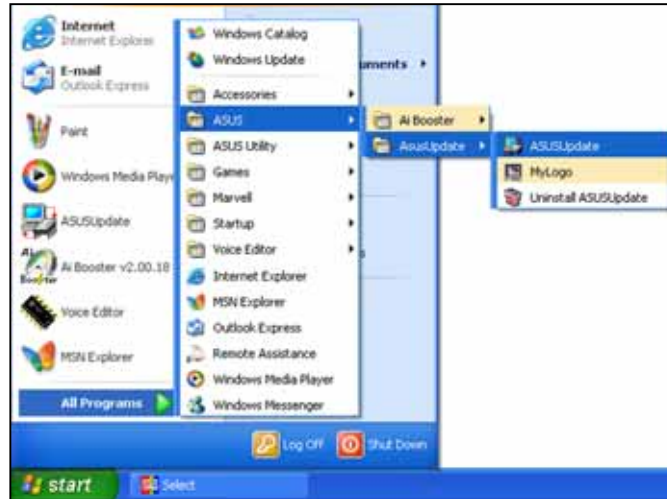

2. Select **Update BIOS from the Internet** option from the drop-down menu, then click **Next**.



3. Select the ASUS FTP site nearest you to avoid network traffic, or click **Auto Select**. Click **Next**.

- From the FTP site, select the BIOS version that you wish to download. Click Next.
- Follow the screen instructions to complete the update process.



The ASUS Update utility is capable of updating itself through the Internet. Always update the utility to avail of all its features.



Updating the BIOS through a BIOS file

To update the BIOS through a BIOS file:

- Launch the ASUS Update utility from the Windows® desktop by clicking **Start > Programs > ASUS > ASUSUpdate > ASUSUpdate**. The ASUS Update main window appears.
- Select **Update BIOS from a file** option from the drop-down menu, then click **Next**.



- Locate the BIOS file from the **Open** window, then click **Save**.
- Follow the screen instructions to complete the update process.

4.2 BIOS setup program

This motherboard supports a programmable firmware chip that you can update using the provided utility described in section “4.1 Managing and updating your BIOS.”

Use the BIOS Setup program when you are installing a motherboard, reconfiguring your system, or prompted to “Run Setup.” This section explains how to configure your system using this utility.

Even if you are not prompted to use the Setup program, you can change the configuration of your computer in the future. For example, you can enable the security password feature or change the power management settings. This requires you to reconfigure your system using the BIOS Setup program so that the computer can recognize these changes and record them in the CMOS RAM of the firmware hub.

The firmware hub on the motherboard stores the Setup utility. When you start up the computer, the system provides you with the opportunity to run this program. Press during the Power-On-Self-Test (POST) to enter the Setup utility; otherwise, POST continues with its test routines.

If you wish to enter Setup after POST, restart the system by pressing <Ctrl+Alt+Delete>, or by pressing the reset button on the system chassis. You can also restart by turning the system off and then back on. Do this last option only if the first two failed.

The Setup program is designed to make it as easy to use as possible. Being a menu-driven program, it lets you scroll through the various sub-menus and make your selections from the available options using the navigation keys.



-
- The default BIOS settings for this motherboard apply for most conditions to ensure optimum performance. If the system becomes unstable after changing any BIOS settings, load the default settings to ensure system compatibility and stability. Select the **Load Setup Defaults** item under the Exit Menu. See section “4.7 Exit Menu.”
 - The BIOS setup screens shown in this section are for reference purposes only, and may not exactly match what you see on your screen.
 - Visit the ASUS website (www.asus.com) to download the latest BIOS file for this motherboard.
-

4.2.1 BIOS menu screen

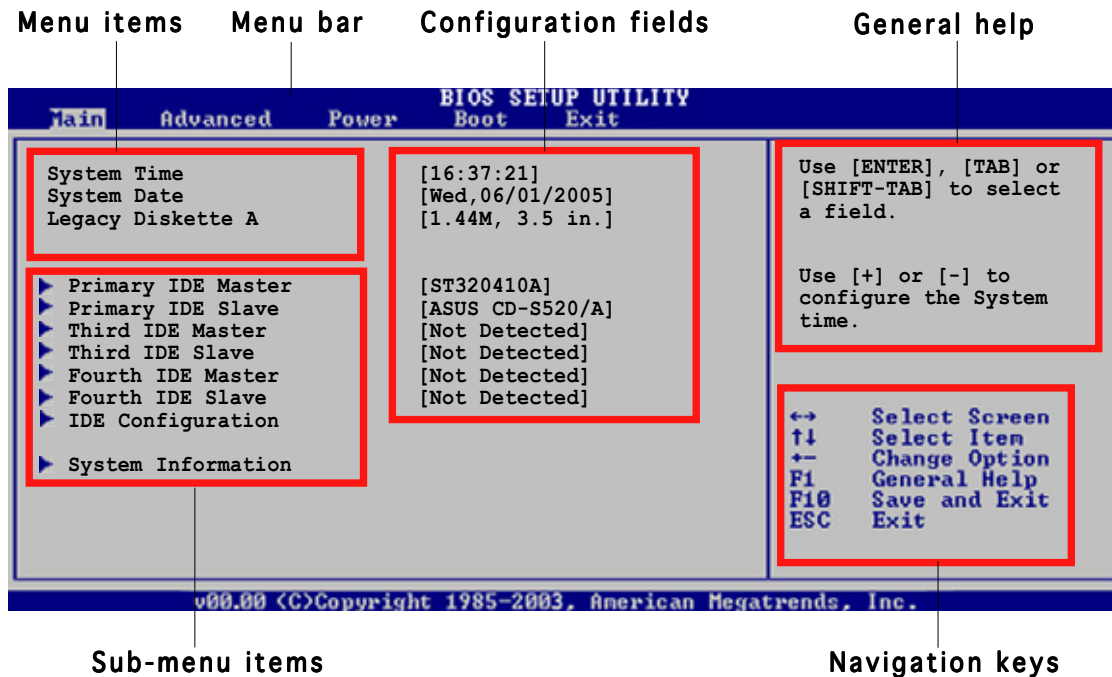

4.2.2 Menu bar

The menu bar on top of the screen has the following main items:

Main	For changing the basic system configuration
Advanced	For changing the advanced system settings
Power	For changing the advanced power management (APM) configuration
Boot	For changing the system boot configuration
Exit	For selecting the exit options and loading default settings

To select an item on the menu bar, press the right or left arrow key on the keyboard until the desired item is highlighted.

4.2.3 Navigation keys

At the bottom right corner of a menu screen are the navigation keys for that particular menu. Use the navigation keys to select items in the menu and change the settings.



Some of the navigation keys differ from one screen to another.

4.2.4 Menu items

The highlighted item on the menu bar displays the specific items for that menu. For example, selecting **Main** shows the Main menu items.

The other items (Advanced, Power, Boot, and Exit) on the menu bar have their respective menu items.

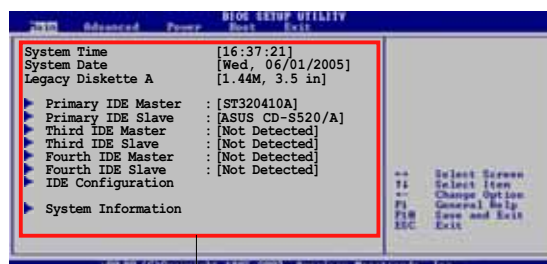

Main menu items

4.2.5 Sub-menu items

A solid triangle before each item on any menu screen means that the item has a sub-menu. To display the sub-menu, select the item and press <Enter>.

4.2.6 Configuration fields

These fields show the values for the menu items. If an item is user-configurable, you can change the value of the field opposite the item. You cannot select an item that is not user-configurable.

A configurable field is enclosed in brackets, and is highlighted when selected. To change the value of a field, select it then press <Enter> to display a list of options. Refer to “4.2.7 Pop-up window.”

4.2.7 Pop-up window

Select a menu item then press <Enter> to display a pop-up window with the configuration options for that item.

4.2.8 Scroll bar

A scroll bar appears on the right side of a menu screen when there are items that do not fit on the screen.

Press the

Up/Down arrow keys or <Page Up> / <Page Down> keys to display the other items on the screen.

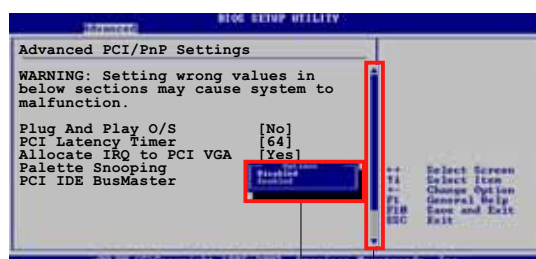

Pop-up window

Scroll bar

4.2.9 General help

At the top right corner of the menu screen is a brief description of the selected item.

4.3 Main menu

When you enter the BIOS Setup program, the Main menu screen appears, giving you an overview of the basic system information.



Refer to section “4.2.1 BIOS menu screen” for information on the menu screen items and how to navigate through them.

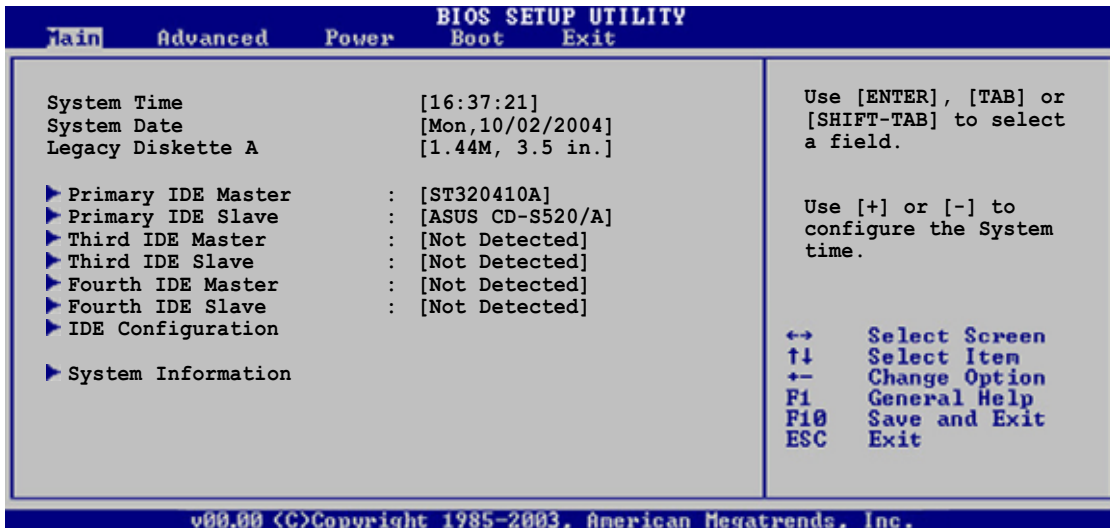

4.3.1 System Time [xx:xx:xx]

Sets the system time.

4.3.2 System Date [Day xx/xx/xxxx]

Sets the system date.

4.3.3 Legacy Diskette A [1.44M, 3.5 in.]

Sets the type of floppy drive installed. Configuration options: [Disabled] [360K, 5.25 in.] [1.2M, 5.25 in.] [720K, 3.5 in.] [1.44M, 3.5 in.] [2.88M, 3.5 in.]

4.3.4 Primary, Third, and Fourth IDE Master/Slave

While entering Setup, the BIOS automatically detects the presence of IDE devices. There is a separate sub-menu for each IDE device. Select a device item then press <Enter> to display the IDE device information.

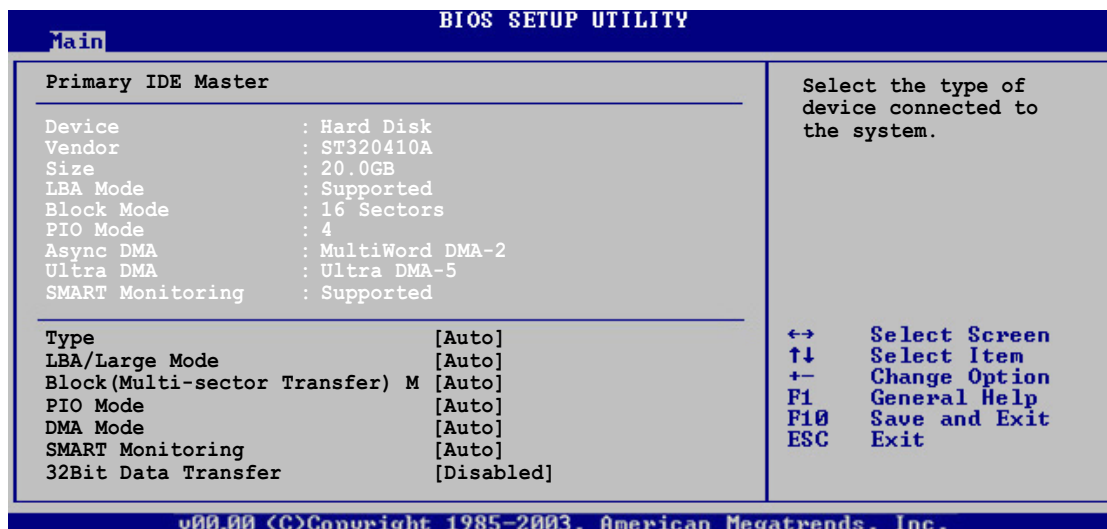

The BIOS automatically detects the values opposite the dimmed items (Device, Vendor, Size, LBA Mode, Block Mode, PIO Mode, Async DMA, Ultra DMA, and SMART monitoring). These values are not user-configurable. These items show N/A if no IDE device is installed in the system.

Type [Auto]

Selects the type of IDE drive. Setting to Auto allows automatic selection of the appropriate IDE device type. Select CDROM if you are specifically configuring a CD-ROM drive. Select ARMD (ATAPI Removable Media Device) if your device is either a ZIP, LS-120, or MO drive. Configuration options: [Not Installed] [Auto] [CDROM] [ARMD]

LBA/Large Mode [Auto]

Enables or disables the LBA mode. Setting to Auto enables the LBA mode if the device supports this mode, and if the device was not previously formatted with LBA mode disabled. Configuration options: [Disabled] [Auto]

Block (Multi-sector Transfer) [Auto]

Enables or disables data multi-sectors transfers. When set to Auto, the data transfer from and to the device occurs multiple sectors at a time if the device supports multi-sector transfer feature. When set to [Disabled], the data transfer from and to the device occurs one sector at a time. Configuration options: [Disabled] [Auto]

PIO Mode [Auto]

Selects the PIO mode.

Configuration options: [Auto] [0] [1] [2] [3] [4]

DMA Mode [Auto]

Allows the BIOS to automatically select the DMA mode.

Configuration option: [Auto]

SMART Monitoring [Auto]

Sets the Smart Monitoring, Analysis, and Reporting Technology.

Configuration options: [Auto] [Disabled] [Enabled]

32Bit Data Transfer [Disabled]

Enables or disables 32-bit data transfer.

Configuration options: [Disabled] [Enabled]

4.3.5 IDE Configuration

The items in this menu allow you to set or change the configurations for the IDE devices installed in the system. Select an item then press <Enter> if you want to configure the item.

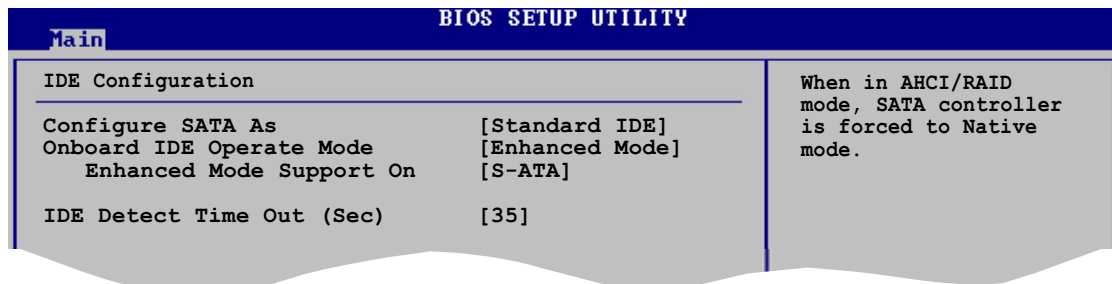

Configure SATA As [Standard IDE]

Sets the Serial ATA configuration. When set in Advanced Host Controller Interface (AHCI) or RAID mode the SATA controller is set to Native mode.

Configuration options: [Standard IDE] [AHCI] [RAID]

Onboard IDE Operate Mode [Enhanced Mode]

Allows selection of the IDE operation mode depending on the operating system (OS) that you installed. Set to Enhanced Mode if you are using native OS, such as Windows® 2000/XP. Configuration options: [Disabled] [Compatible Mode] [Enhanced Mode]



If the **Onboard IDE Operate Mode** is set to [Compatible], you can only use the SATA2, SATA4, and P-ATA connectors.

Enhanced Mode Support On [S-ATA]

The default setting SATA allows you to use native OS on Serial ATA and Parallel ATA ports. We recommend that you do not change the default setting for better OS compatibility. In this setting, you may use legacy OS on the Parallel ATA ports **only if** you did not install any Serial ATA device.

The S-ATA+P-ATA and P-ATA options are for advanced users only. If you set to any of these options and encounter problems, revert to the default setting **SATA**. Configuration options: [S-ATA+P-ATA] [S-ATA] [P-ATA]



The **Onboard IDE Operate Mode** and its submenu items appear only when the **Configure SATA As** item is set to Standard IDE.

Onboard Serial-ATA BOOTROM [Disabled]

Enables or disables the onboard Serial ATA boot ROM.
Configuration options: [Disabled] [Enabled]



The **Onboard Serial-ATA BOOTROM** item appears only when the **Configure SATA As** item is set to RAID.

ALPE and ASP [Disabled]

Enables or disables the ALPE and ASP.
Configuration options: [Disabled] [Enabled]

Stagger Spinup Support [Disabled]

Enables or disables the stagger spinup support.
Configuration options: [Disabled] [Enabled]

AHCI Port 3 Interlock Switch [Disabled]

Enables or disables the Advanced Host Controller Interface (AHCI) Port 3 interlock switch. Configuration options: [Disabled] [Enabled]



The **ALPE and ASP** item appears only when the **Configure SATA As** item is set to AHCI.

IDE Detect Time Out [35]

Selects the time out value for detecting ATA/ATAPI devices.
Configuration options: [0] [5] [10] [15] [20] [25] [30] [35]

4.3.6 System Information

This menu gives you an overview of the general system specifications. The BIOS automatically detects the items in this menu.

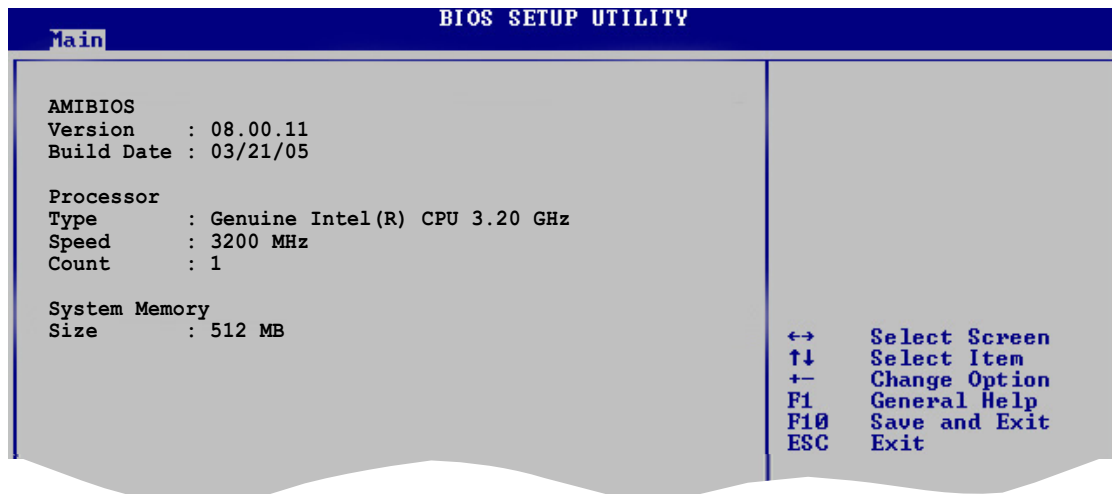

AMI BIOS

Displays the auto-detected BIOS information.

Processor

Displays the auto-detected CPU specification.

System Memory

Displays the auto-detected system memory.

4.4 Advanced menu

The Advanced menu items allow you to change the settings for the CPU and other system devices.



Take caution when changing the settings of the Advanced menu items. Incorrect field values can cause the system to malfunction.

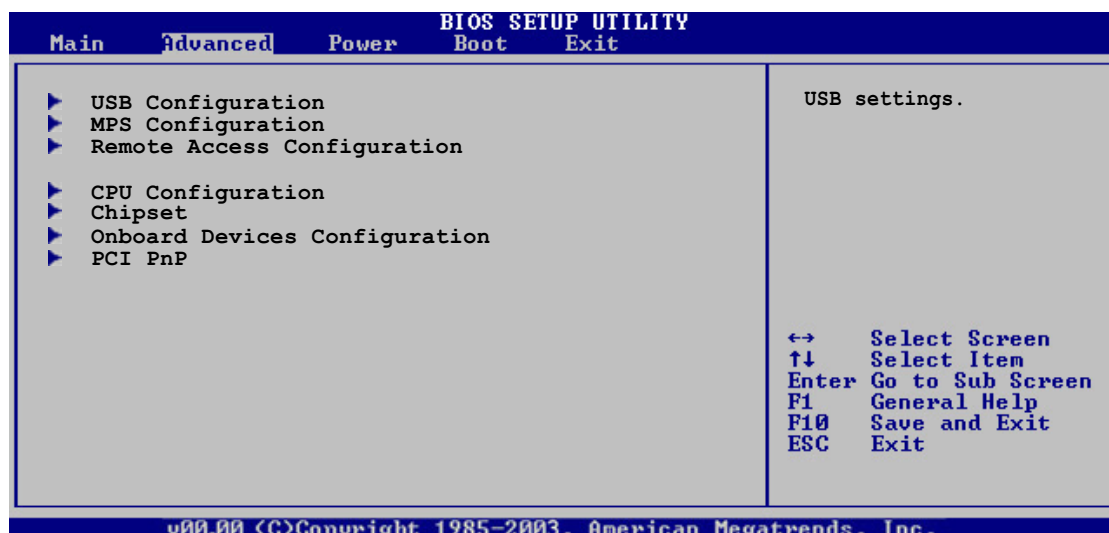

4.4.1 USB Configuration

The items in this menu allow you to change the USB-related features. Select an item then press <Enter> to display the configuration options.

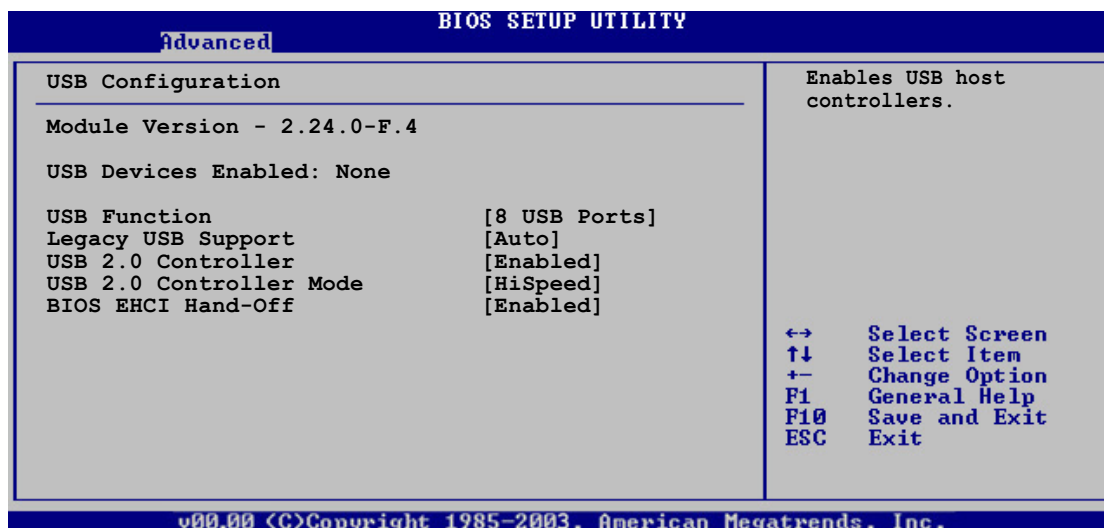

The **Module Version** and **USB Devices Enabled** items show the auto-detected values. If no USB device is detected, the item shows **None**.

USB Function [8 USB Ports]

Allows you to disable or set the USB host controllers.

Configuration options: [Disabled] [2 USB Ports] [4 USB Ports]
[6 USB Ports] [8 USB Ports]

Legacy USB Support [Enabled]

Allows you to enable or disable support for USB devices on legacy operating systems (OS). Setting to Auto allows the system to detect the presence of USB devices at startup. If detected, the USB controller legacy mode is enabled. If no USB device is detected, the legacy USB support is disabled. Configuration options: [Disabled] [Enabled] [Auto]

USB 2.0 Controller [Enabled]

Allows you to enable or disable the USB 2.0 controller.

Configuration options: [Enabled] [Disabled]

USB 2.0 Controller Mode [HiSpeed]

Allows you to set the USB 2.0 controller mode to HiSpeed (480 Mbps) or FullSpeed (12 Mbps). Configuration options: [FullSpeed] [HiSpeed]

BIOS EHCI Hand-Off [Enabled]

This is a workaround for operating systems without EHCI hand-off support. The ownership should be claimed by the EHCI driver.

Configuration options: [Disabled] [Enabled]

4.4.2 MPS Configuration

This menu allows you to configure the Multi-Processor table. Select an item then press <Enter> to display the configuration options.

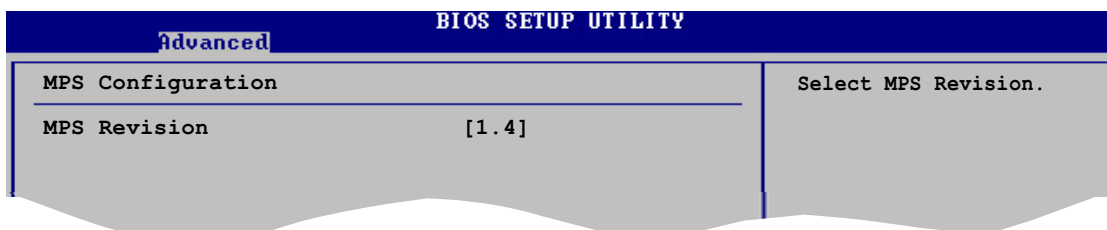

MPS Revision [1.4]

Allows you to choose the MPS revision.

Configuration options: [1.1] [1.4]

4.4.3 Remote Access Configuration

The items in this menu allow you to configure the Remote Access features. Select an item then press <Enter> to display the configuration options.

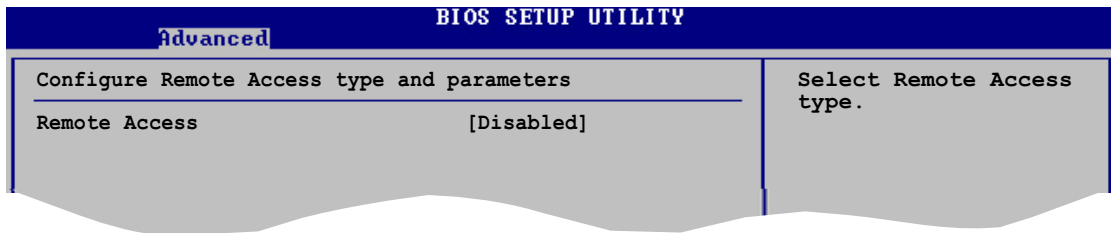

Remote Access [Disabled]

Enables or disables the remote access feature.
Configuration options: [Disabled] [Enabled]



The succeeding items appear when the item **Remote Access** is set to [Enabled].

Serial port number [COM1]

Sets the serial port for console redirection. Make sure the selected port is enabled. Configuration options: [COM1] [COM2]

Base Address, IRQ [3F8h, 4]

Sets the base address and IRQ assignment of the selected serial port. This item is auto-detected and is not user-configurable.

Serial Port Mode [115200, 8,n,1]

Allows you to select the serial port mode settings.
Configuration options: [115200 8,n,1] [57600 8,n,1] [38400 8,n,1]
[19200 8,n,1] [09600 8,n,1]

Flow Control [None]

Allows you to select the flow control for console redirection.
Configuration options: [None] [Hardware] [Software]

Redirection after BIOS POST [Always]

Sets the redirection mode after the BIOS Power-On-Self-Test (POST). Some operating systems may not work when this item is set to [Always].
Configuration options: [Disabled] [Boot Loader] [Always]

Terminal Type [ANSI]

Allows you to select the target terminal type.
Configuration options: [ANSI] [VT100] [VT-UTF8]

VT-UTF8 Combo Key Support [Enabled]

Enables or disables the VT-UTF8 combo key support for ANSI or VT100 terminals. Configuration options: [Disabled] [Enabled]

4.4.4 CPU Configuration

The items in this menu show the CPU-related information that the BIOS automatically detects.

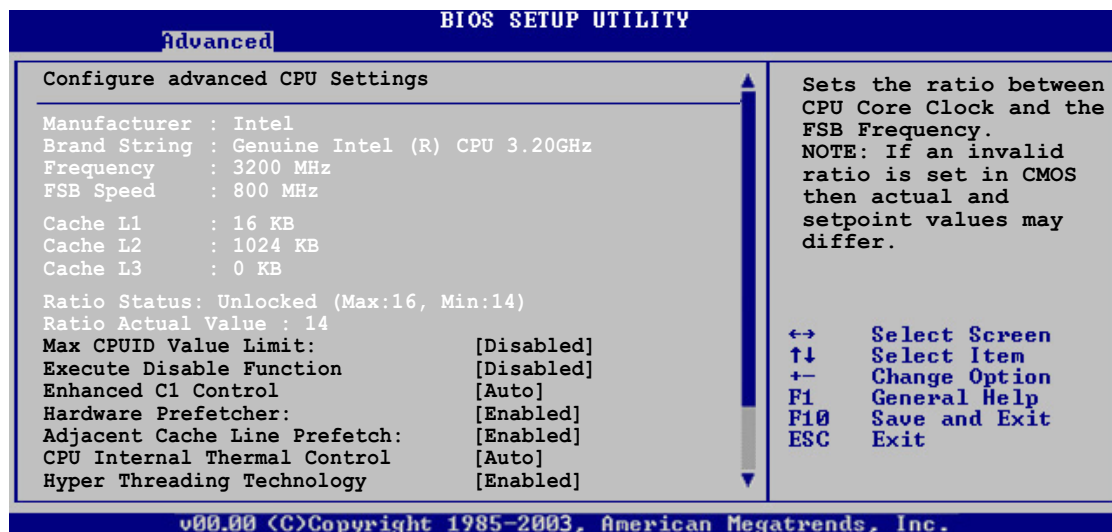

Max CPUID Value Limit [Disabled]

Enable this item to boot legacy operating systems that cannot support CPUs with extended CPUID functions. Configuration options: [Disabled] [Enabled]

Execute Disable Function [Disabled]

Allows you to enable or disable the execute disable function. Configuration options: [Disabled] [Enabled]

Enhanced C1 Control [Auto]

When set to [Auto], the BIOS will automatically check the CPU's capability to enable the C1E support. In C1E mode, the CPU power consumption is lower when idle. Configuration options: [Auto] [Disabled]

Hardware Prefetcher [Enabled]

Allows you to enable or disable the hardware prefetcher feature. Configuration options: [Disabled] [Enabled]

Adjacent Cache Line Prefetch [Enabled]

Allows you to enable or disable the adjacent cache line prefetch feature.
Configuration options: [Disabled] [Enabled]

CPU Internal Thermal Control [Auto]

Disables or sets the CPU internal thermal control.
Configuration options: [Auto] [Disabled]



The following item appears only when you installed an Intel® Pentium® 4 processor that supports Hyper Threading Technology.

Hyper Threading Technology [Enabled]

Allows you to enable or disable the processor Hyper Threading Technology.
Configuration options: [Disabled] [Enabled]

4.4.5 Chipset

The Chipset menu allows you to change the advanced chipset settings.
Select an item then press <Enter> to display the sub-menu.

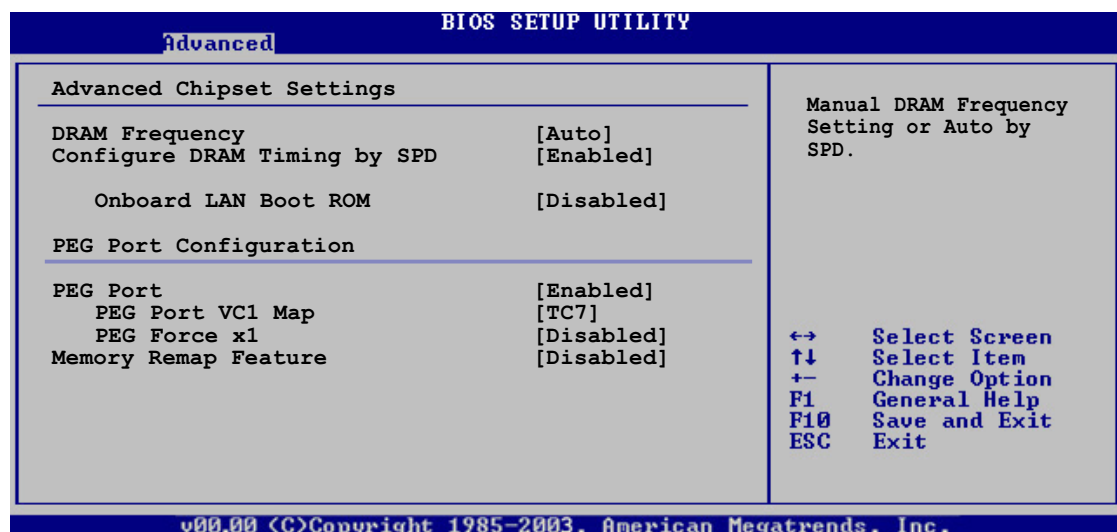

DRAM Frequency [Auto]

Allows you to manually set the DRAM frequency. Setting to [Auto] allows the BIOS to automatically set the DRAM frequency by Serial Presence Detect (SPD). Configuration options: [Auto] [533 MHz] [667 MHz]

Configure DRAM Timing by SPD [Enabled]

When this item is enabled, the DRAM timing parameters are set according to the DRAM SPD (Serial Presence Detect). When disabled, you can manually set the DRAM timing parameters through the DRAM sub-items. Configuration options: [Disabled] [Enabled]

The following sub-items appear when this item is Disabled.

DRAM CAS# Latency [5 Clocks]

Controls the latency between the SDRAM read command and the time the data actually becomes available.

Configuration options: [5 Clocks] [4 Clocks] [3 Clocks] [6 Clocks]

DRAM RAS# Precharge [4 Clocks]

Controls the idle clocks after issuing a precharge command to the DDR SDRAM. Configuration options: [2 Clocks] [3 Clocks] [4 Clocks]

[5 Clocks]

DRAM RAS# to CAS# Delay [4 Clocks]

Controls the latency between the DDR SDRAM active command and the read/write command. Configuration options: [2 Clocks] [3 Clocks]

[4 Clocks] [5 Clocks]

DRAM RAS# Activate to Precharge Delay [15 Clocks]

Configuration options: [1 Clock] ~ [15 Clocks]

DRAM Write Recovery Time [4 Clocks]

Sets the DRAM write recovery time.

Configuration options: [2 Clocks] [3 Clocks] [4 Clocks] [5 Clocks]

Onboard LAN Boot ROM [Disabled]

Allows you to enable or disable the onboard LAN boot ROM.

Configuration options: [Disabled] [Enabled]

PEG Port [Enabled]

Allows you to enable or disable the PCI Express Graphics port.

Configuration options: [Disabled] [Enabled]

PEG Port VC1 Map [TC7]

Allows you to disable or set the PCI Express Graphics port VC1 map.

Configuration options: [Disabled] [TC1] ~ [TC7]

PEG Force x1 [Disabled]

Configuration options: [Disabled] [Enabled]

Memory Remap Feature [Disabled]

Allows you to enable or disable the memory remap feature.

Configuration options: [Disabled] [Enabled]

4.4.6 Onboard Devices Configuration

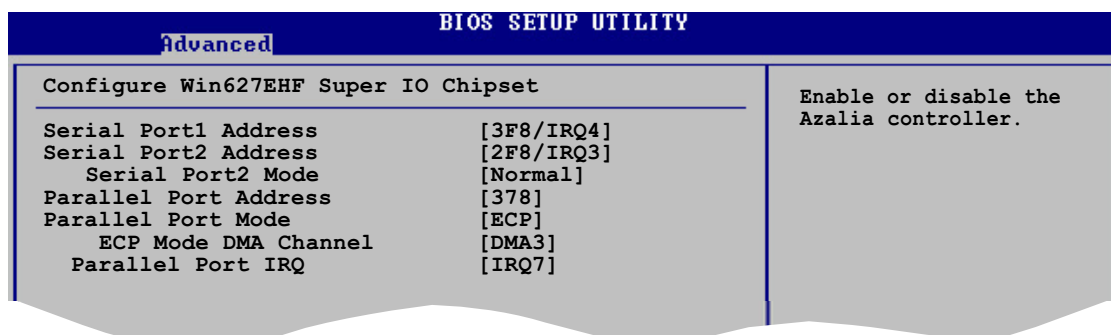

Serial Port1 Address [3F8/IRQ4]

Allows you to select the Serial Port1 base address.

Configuration options: [Disabled] [3F8/IRQ4] [3E8/IRQ4] [2E8/IRQ3]

Serial Port2 Address [2F8/IRQ3]

Allows you to select the Serial Port1 base address.

Configuration options: [Disabled] [2F8/IRQ3] [3E8/IRQ4] [2E8/IRQ3]

Serial Port2 Mode [Normal]

Allows the BIOS to select the Serial Port 2 mode.

Configuration options: [Normal] [IrDA] [ASK IR]

Parallel Port Address [378]

Allows you to select the Parallel Port base addresses.

Configuration options: [Disabled] [378] [278] [3BC]

Parallel Port Mode [ECP]

Allows you to select the Parallel Port mode.

Configuration options: [Normal] [Bi-directional] [EPP] [ECP]

ECP Mode DMA Channel [DMA3]

Appears only when the Parallel Port Mode is set to [ECP]. This item allows you to set the Parallel Port ECP DMA.

Configuration options: [DMA0] [DMA1] [DMA3]

EPP Version [1.9]

Allows selection of the Parallel Port EPP version. This item appears only when the **Parallel Port Mode** is set to **EPP**.

Configuration options: [1.9] [1.7]

Parallel Port IRQ [IRQ7]

Allows selection of the Parallel Port IRQ.

Configuration options: [IRQ5] [IRQ7]

4.4.7 PCI PnP

The PCI PnP menu items allow you to change the advanced settings for PCI/PnP devices. The menu includes setting IRQ and DMA channel resources for either PCI/PnP or legacy ISA devices, and setting the memory size block for legacy ISA devices.



Take caution when changing the settings of the PCI PnP menu items. Incorrect field values can cause the system to malfunction.



Plug and Play O/S [No]

When set to [No], BIOS configures all the devices in the system. When set to [Yes] and if you install a Plug and Play operating system, the operating system configures the Plug and Play devices not required for boot.

Configuration options: [No] [Yes]

PCI Latency Timer [64]

Allows you to select the value in units of PCI clocks for the PCI device latency timer register. Configuration options: [32] [64] [96] [128] [160] [192] [224] [248]

Allocate IRQ to PCI VGA [Yes]

When set to [Yes], BIOS assigns an IRQ to PCI VGA card if the card requests for an IRQ. When set to [No], BIOS does not assign an IRQ to the PCI VGA card even if requested. Configuration options: [Yes] [No]

Palette Snooping [Disabled]

When set to [Enabled], the palette snooping feature informs the PCI devices that an ISA graphics device is installed in the system so that the latter can function correctly. Configuration options: [Disabled] [Enabled]

IRQ-xx assigned to [PCI Device]

When set to [PCI Device], the specific IRQ is free for use of PCI/PnP devices. When set to [Reserved], the IRQ is reserved for legacy ISA devices. Configuration options: [PCI Device] [Reserved]

4.5 Power menu

The Power menu items allow you to change the settings for the ACPI and Advanced Power Management (APM). Select an item then press <Enter> to display the configuration options.

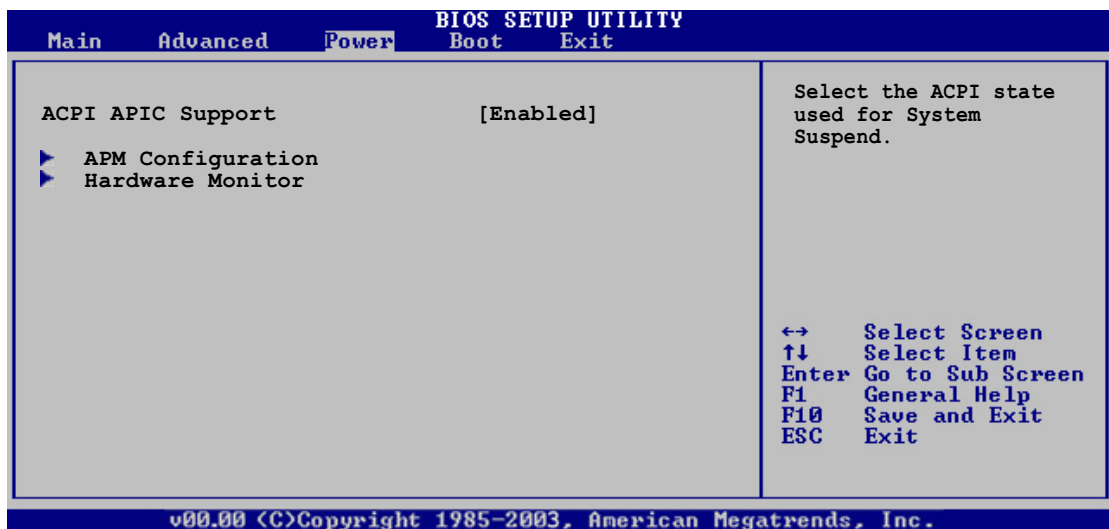

4.5.1 ACPI APIC Support [Enabled]

Allows you to enable or disable the Advanced Configuration and Power Interface (ACPI) support in the Advanced Programmable Interrupt Controller (APIC). When set to Enabled, the ACPI APIC table pointer is included in the RSDT pointer list. Configuration options: [Disabled] [Enabled]

4.5.2 APM Configuration

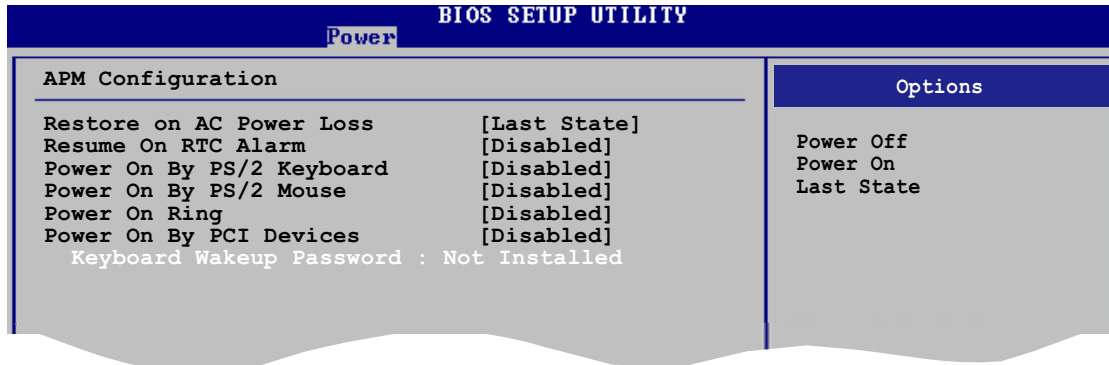

Restore on AC Power Loss [Last State]

When set to Power Off, the system goes into off state after an AC power loss. When set to Power On, the system goes on after an AC power loss. When set to Last State, the system goes into either off or on state, whatever the system state was before the AC power loss.
Configuration options: [Power Off] [Power On] [Last State]

Resume On RTC Alarm [Disabled]

Allows you to enable or disable RTC to generate a wake event. When this item is set to Enabled, the items RTC Alarm Date, RTC Alarm Hour, RTC Alarm Minute, and RTC Alarm Second appear with set values. Configuration options: [Disabled] [Enabled]

Power On By PS/2 Keyboard [Disabled]

Allows you to use specific keys on the keyboard to turn on the system. This feature requires an ATX power supply that provides at least 1A on the +5VSB lead. Configuration options: [Disabled] [Enabled]

Power On By PS/2 Mouse [Disabled]

When set to [Enabled], this parameter allows you to use the PS/2 mouse to turn on the system. This feature requires an ATX power supply that provides at least 1A on the +5VSB lead.
Configuration options: [Disabled] [Enabled]

Power On Ring [Disabled]

Allows you to enable or disable the RI to generate a wake event.
Configuration options: [Disabled] [Enabled]

Power On By PCI Devices [Disabled]

When set to [Enabled], this parameter allows you to turn on the system through a PCI LAN or modem card. This feature requires an ATX power supply that provides at least 1A on the +5VSB lead.

Configuration options: [Disabled] [Enabled]

Keyboard Wakeup Password

This item appears only when the Power On By PS/2 Keyboard is set to Enabled. Select this item to set or change the keyboard wakeup password. The **Keyboard Wakeup Password** item that appears below shows the default **Not Installed**. After you have set a password, this item shows **Installed**.

4.5.3 Hardware Monitor

BIOS SETUP UTILITY	
Power	
Hardware Monitor	
CPU Temperature	[51°C/122.5°F]
MB Temperature	[41°C/105.5°F]
CPU1 Fan Speed	[3813 RPM]
CPU2 Fan Speed	[N/A]
Front Fan1 Speed	[N/A]
Front Fan2 Speed	[N/A]
Rear Fan1 Speed	[N/A]
Rear Fan2 Speed	[N/A]
Smart Fan Control	[Disabled]
VCORE1 Voltage	[1.320V]
3.3V Voltage	[3.345V]
5V Voltage	[5.094V]
5VSB Voltage	[4.824V]
VBAT Voltage	[3.040V]
12V Voltage	[11.880V]
CPU1 Temperature	
↔	Select Screen
↑↓	Select Item
+ -	Change Option
F1	General Help
F10	Save and Exit
ESC	Exit

CPU Temperature [xxx°C/xxx°F]

MB Temperature [xxx°C/xxx°F]

The onboard hardware monitor automatically detects and displays the motherboard, CPU, and ambient temperatures. Select Ignored if you do not wish to display the detected temperatures.

CPU Fan 1/2 Speed [xxxxRPM] or [N/A]
Front Fan1/2 Speed [xxxxRPM] or [N/A]
Rear Fan1/2 Speed [xxxxRPM] or [N/A]

The onboard hardware monitor automatically detects and displays the CPU fan speed in rotations per minute (RPM). If the fan is not connected to the motherboard, the field shows N/A.

Smart Fan Control [Disabled]

Allows you to enable or disable the ASUS Smart Fan feature that smartly adjusts the fan speeds for more efficient system operation.

Configuration options: [Disabled] [Enabled]



When **Smart Fan Control** item is set to [Enabled], the **CPU Temperature** item appears.

CPU Temperature [xxx]

Allows you to set the temperature threshold when the CPU fan speed is increased. If the CPU/MB temperature is above your setting, the CPU fan runs at its maximum speed. If the CPU/MB temperature is below your setting, the CPU fan runs at a lower speed. To set, use the <-> or <+> key.

Configuration options: [Disabled] [Enabled]

VCORE1 Voltage, 3.3V Voltage, 5V Voltage, 5VSB Voltage, VBAT Voltage, 12V Voltage

The onboard hardware monitor automatically detects the voltage output through the onboard voltage regulators.

4.6 Boot menu

The Boot menu items allow you to change the system boot options. Select an item then press <Enter> to display the sub-menu.

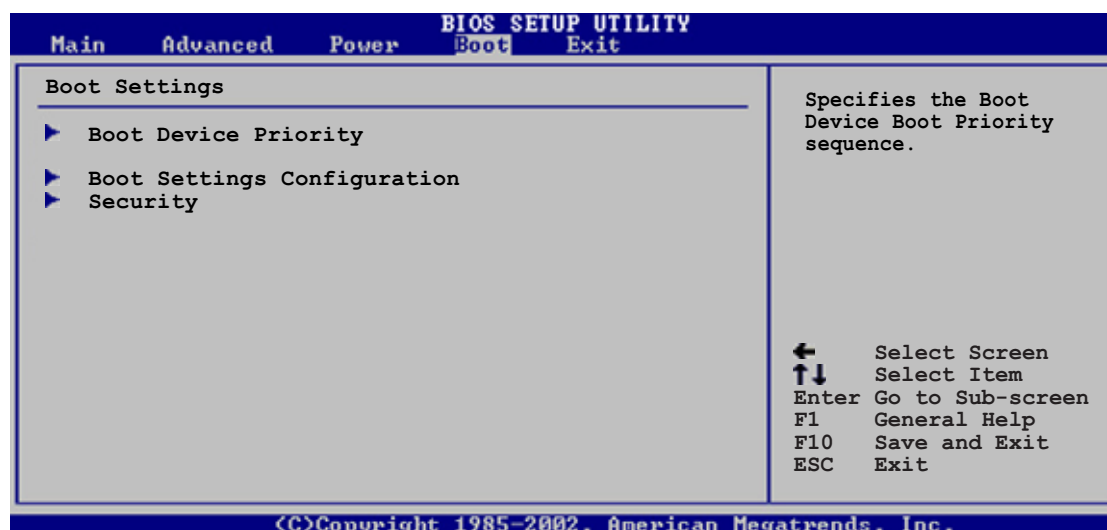

4.6.1 Boot Device Priority

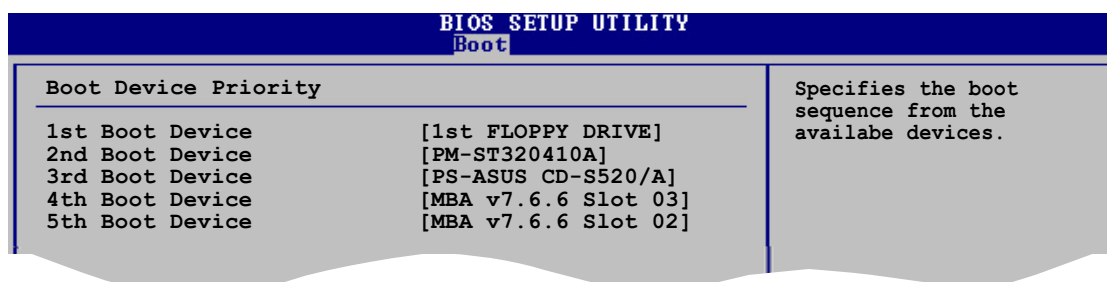

1st ~ xxth Boot Device [1st Floppy Drive]

These items specify the boot device priority sequence from the available devices. The number of device items that appears on the screen depends on the number of devices installed in the system.

Configuration options: [xxxxx Drive] [Disabled]

4.6.2 Boot Settings Configuration

BIOS SETUP UTILITY	
Boot	
Boot Settings Configuration	
Quick Boot	[Enabled]
Full Screen Logo	[Enabled]
AddOn ROM Display Mode	[ForceBIOS]
Bootup Num-Lock	[On]
PS/2 Mouse Support	[Auto]
Wait For 'F1' If Error	[Enabled]
Hit 'DEL' Message Display	[Enabled]
Interrupt 19 Capture	[Enabled]

Allows BIOS to skip certain tests while booting. This will decrease the time needed to boot the system.

Quick Boot [Enabled]

Enabling this item allows the BIOS to skip some power on self tests (POST) while booting to decrease the time needed to boot the system. When set to [Disabled], BIOS performs all the POST items.

Configuration options: [Disabled] [Enabled]

Full Screen Logo [Enabled]

This allows you to enable or disable the full screen logo display feature.

Configuration options: [Disabled] [Enabled]



Set this item to [Enabled] to use the ASUS MyLogo2™ feature.

AddOn ROM Display Mode [ForceBIOS]

Sets the display mode for the option ROM.

Configuration options: [ForceBIOS] [Keep Current]

Bootup Num-Lock [On]

Allows you to select the power-on state for the NumLock.

Configuration options: [Off] [On]

PS/2 Mouse Support [Auto]

Allows you to enable or disable support for PS/2 mouse.

Configuration options: [Disabled] [Enabled] [Auto]

Wait for 'F1' If Error [Enabled]

When set to Enabled, the system waits for the F1 key to be pressed when error occurs. Configuration options: [Disabled] [Enabled]

Hit 'DEL' Message Display [Enabled]

When set to Enabled, the system displays the message "Press DEL to run Setup" during POST. Configuration options: [Disabled] [Enabled]

Interrupt 19 Capture [Enabled]

When set to [Enabled], this function allows the option ROMs to trap Interrupt 19. Configuration options: [Disabled] [Enabled]

4.6.3 Security

The Security menu items allow you to change the system security settings. Select an item then press <Enter> to display the configuration options.

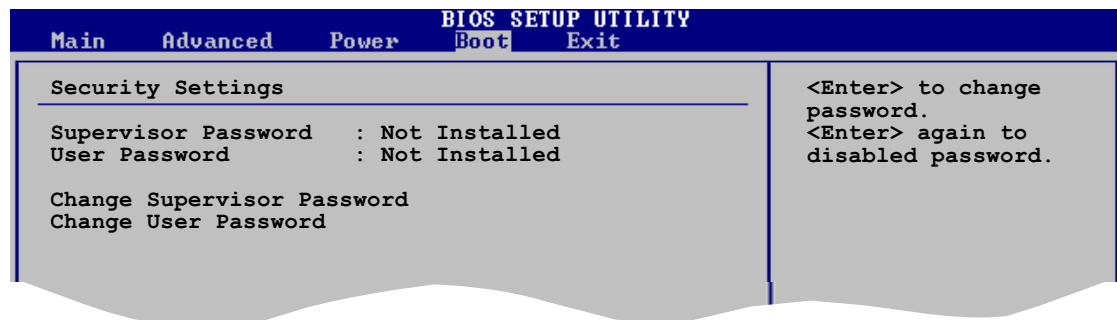

Change Supervisor Password

Select this item to set or change the supervisor password. The Supervisor Password item on top of the screen shows the default **Not Installed**. After you set a password, this item shows **Installed**.

To set a Supervisor Password:

1. Select the Change Supervisor Password item and press <Enter>.
2. From the password box, type a password composed of at least six letters and/or numbers, then press <Enter>.
3. Confirm the password when prompted.

The message "Password Installed" appears after you successfully set your password.

To change the supervisor password, follow the same steps as in setting a user password.

To clear the supervisor password, select the Change Supervisor Password then press <Enter>. The message "Password Uninstalled" appears.



If you forget your BIOS password, you can clear it by erasing the CMOS Real Time Clock (RTC) RAM. See section “2.6 Jumpers” for information on how to erase the RTC RAM.

After you have set a supervisor password, the other items appear to allow you to change other security settings.

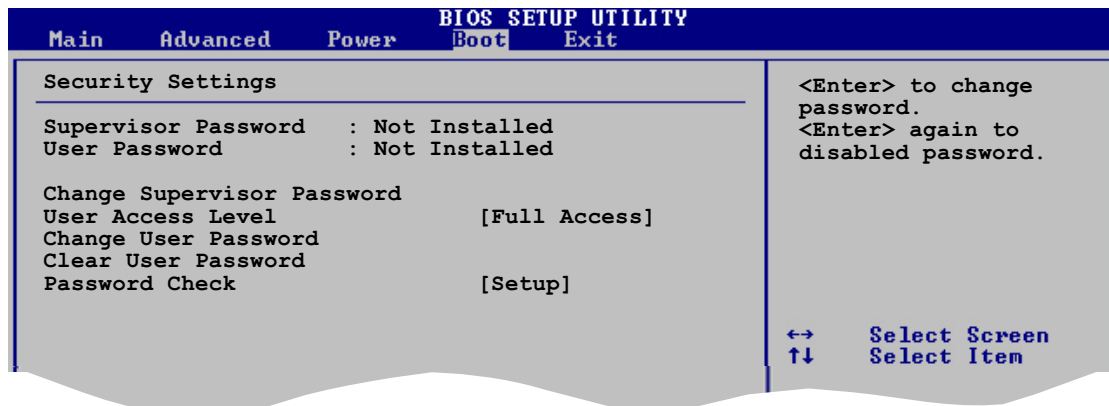

User Access Level (Full Access]

This item allows you to select the access restriction to the Setup items. Configuration options: [No Access] [View Only] [Limited] [Full Access]

No Access prevents user access to the Setup utility.

View Only allows access but does not allow change to any field.

Limited allows changes only to selected fields, such as Date and Time.

Full Access allows viewing and changing all the fields in the Setup utility.

Change User Password

Select this item to set or change the user password. The User Password item on top of the screen shows the default **Not Installed**. After you set a password, this item shows **Installed**.

To set a User Password:

1. Select the Change User Password item and press <Enter>.
2. On the password box that appears, type a password composed of at least six letters and/or numbers, then press <Enter>.
3. Confirm the password when prompted.

The message “Password Installed” appears after you set your password successfully.

To change the user password, follow the same steps as in setting a user password.

Clear User Password

Select this item to clear the user password.

Password Check [Setup]

When set to [Setup], BIOS checks for user password when accessing the Setup utility. When set to [Always], BIOS checks for user password both when accessing Setup and booting the system.

Configuration options: [Setup] [Always]

4.7 Exit menu

The Exit menu items allow you to load the optimal or failsafe default values for the BIOS items, and save or discard your changes to the BIOS items.

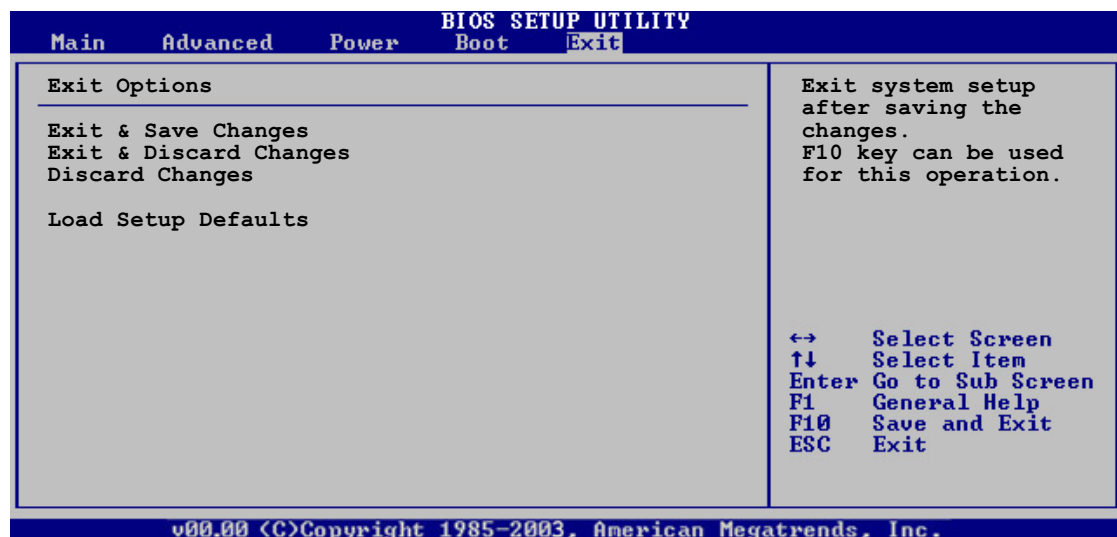

Pressing <Esc> does not immediately exit this menu. Select one of the options from this menu or <F10> from the legend bar to exit.

Exit & Save Changes

Once you are finished making your selections, choose this option from the Exit menu to ensure the values you selected are saved to the CMOS RAM. An onboard backup battery sustains the CMOS RAM so it stays on even when the PC is turned off. When you select this option, a confirmation window appears. Select [OK] to save changes and exit.



If you attempt to exit the Setup program without saving your changes, the program prompts you with a message asking if you want to save your changes before exiting. Press <Enter> to save the changes while exiting.

Exit & Discard Changes

Select this option only if you do not want to save the changes that you made to the Setup program. If you made changes to fields other than System Date, System Time, and Password, the BIOS asks for a confirmation before exiting.

Discard Changes

This option allows you to discard the selections you made and restore the previously saved values. After selecting this option, a confirmation appears. Select [OK] to discard any changes and load the previously saved values.

Load Setup Defaults

This option allows you to load the default values for each of the parameters on the Setup menus. When you select this option or if you press <F5>, a confirmation window appears. Select [OK] to load default values. Select **Exit & Save Changes** or make other changes before saving the values to the non-volatile RAM.

This chapter provides information on RAID configurations for this motherboard.

RAID support

5.1 RAID configurations 5-1

5.1 RAID configurations

The server system/motherboard comes with the **Intel® ICH7R** and the **LSI Logic Embedded SATA RAID** technology built-in the Intel® ICH7R SouthBridge chipset that allows you to configure IDE and Serial ATA hard disk drives as RAID sets. The motherboard supports the following RAID configurations:

5.1.1 RAID definitions

RAID 0 (*Data striping*) optimizes two identical hard disk drives to read and write data in parallel, interleaved stacks. Two hard disks perform the same work as a single drive but at a sustained data transfer rate, double that of a single disk alone, thus improving data access and storage. Use of two new identical hard disk drives is required for this setup.

RAID 1 (*Data mirroring*) copies and maintains an identical image of data from one drive to a second drive. If one drive fails, the disk array management software directs all applications to the surviving drive as it contains a complete copy of the data in the other drive. This RAID configuration provides data protection and increases fault tolerance to the entire system. Use two new drives or use an existing drive and a new drive for this setup. The new drive must be of the same size or larger than the existing drive.

RAID 5 stripes both data and parity information across three or more hard disk drives. Among the advantages of RAID 5 configuration include better HDD performance, fault tolerance, and higher storage capacity. The RAID 5 configuration is best suited for transaction processing, relational database applications, enterprise resource planning, and other business systems. Use a minimum of three identical hard disk drives for this setup.

RAID 10 is a striped configuration with RAID 1 segments whose segments are RAID 1 arrays. This configuration has the same fault tolerance as RAID 1, and has the same overhead for fault-tolerance as mirroring alone. RAID 10 achieves high input/output rates by striping RAID 1 segments. In some instances, a RAID 10 configuration can sustain multiple simultaneous drive failure. A minimum of four hard disk drives is required for this setup.

Intel® Matrix Storage. The Intel® Matrix Storage technology supported by the ICH7R chip allows you to create a RAID 0 and a RAID 1 set using only two identical hard disk drives. The Intel® Matrix Storage technology creates two partitions on each hard disk drive to create a virtual RAID 0 and RAID 1 sets. This technology also allows you to change the hard disk drive partition size without losing any data.



If you want to boot the system from a hard disk drive included in a created RAID set, copy first the RAID driver from the support CD to a floppy disk before you install an operating system to the selected hard disk drive. Refer to section “2. RAID driver installation” for details.

5.1.2 Installing Serial ATA hard disks

The motherboard supports Serial ATA hard disk drives. For optimal performance, install identical drives of the same model and capacity when creating a disk array.

To install the SATA hard disks for a RAID configuration:

1. Install the SATA hard disks into the drive bays.
2. Connect the SATA signal cables.
3. Connect a SATA power cable to the power connector on each drive.

5.1.3 Intel® RAID configurations

This motherboard supports RAID 0, RAID 1, and Intel® Matrix Storage configurations for Serial ATA hard disks drives through the Intel® ICH7R Southbridge chip.

Setting the RAID item in BIOS

You must set the RAID item in the BIOS Setup before you can create a RAID set(s). To do this:

1. Enter the BIOS Setup during POST.
2. Go to the **Main Menu**, select **IDE Configuration**, then press <Enter>.
3. Select the item **Configure SATA As**, then press <Enter> to display the configuration options.
4. Select **RAID** from the **Configure SATA As** item options, then press <Enter>.
5. Select the item **Onboard Serial-ATA BOOTROM**, press <Enter>, then select **Enabled** from the options.
6. Save your changes, then exit the BIOS Setup.



Refer to the system or the motherboard user guide for details on entering and navigating through the BIOS Setup.

Intel® Matrix Storage Manager Option ROM Utility

The Intel® Matrix Storage Manager Option ROM utility allows you to create RAID 0, RAID 1, RAID 10 (RAID 0+1), and RAID 5 set(s) from Serial ATA hard disk drives that are connected to the Serial ATA connectors supported by the Southbridge.

To enter the Intel® Application Accelerator RAID Option ROM utility:

1. Install all the Serial ATA hard disk drives.
2. Turn on the system.
3. During POST, press <Ctrl+I> to display the utility main menu.

```
Intel(R) Matrix Storage Manager Option ROM v5.0.0.1032 ICH7R wRAID5
Copyright(C) 2003-05 Intel Corporation. All Rights Reserved.

[ MAIN MENU ]
1. Create RAID Volume
2. Delete RAID Volume
3. Reset Disks to Non-RAID
4. Exit

[ DISK/VOLUME INFORMATION ]

RAID Volumes:
None defined.

Physical Disks:
Port Drive Model      Serial #              Size      Type/Status(Vol ID)
0  XXXXXXXXXXXX        XXXXXXXX             XX.XXGB  Non-RAID Disk
1  XXXXXXXXXXXX        XXXXXXXX             XX.XXGB  Non-RAID Disk
2  XXXXXXXXXXXX        XXXXXXXX             XX.XXGB  Non-RAID Disk
3  XXXXXXXXXXXX        XXXXXXXX             XX.XXGB  Non-RAID Disk

[↑↓]-Select      [ESC]-Exit      [ENTER]-Select Menu
```

The navigation keys at the bottom of the screen allow you to move through the menus and select the menu options.



The RAID BIOS setup screens shown in this section are for reference only and may not exactly match the items on your screen.

Creating a RAID 0 set (striped)

To create a RAID 0 set:

1. From the utility main menu, select **1. Create RAID Volume**, then press <Enter>. This screen appears.

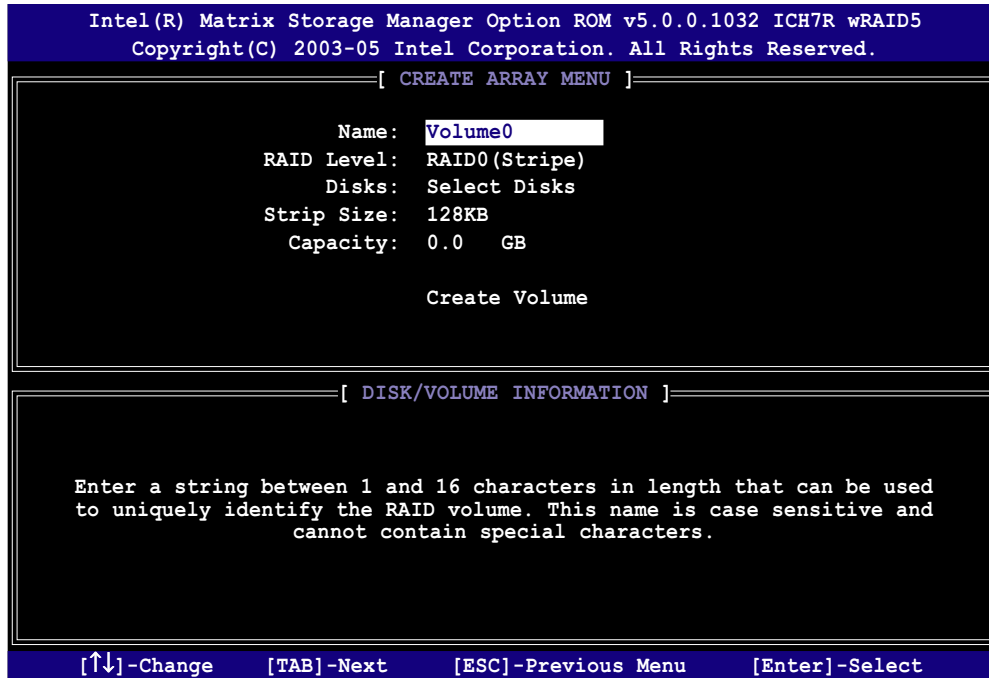

2. Enter a name for the RAID 0 set, then press <Enter>.
3. When the **RAID Level** item is highlighted, press the up/down arrow key to select **RAID 0(Stripe)**, then press <Enter>.
4. When the **Disks** item is highlighted, press <Enter> to select the hard disk drives to configure as RAID. This pop-up screen appears.

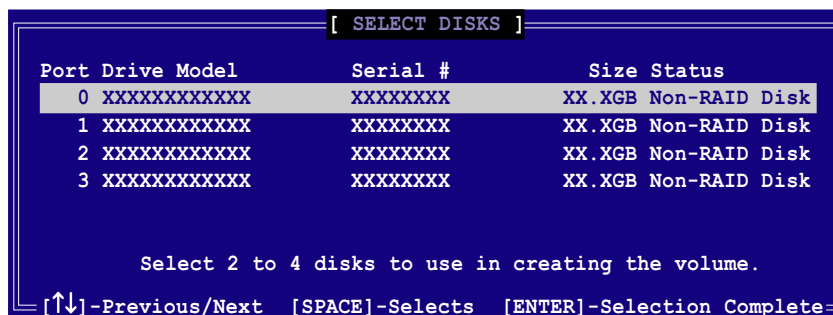

5. Use the up/down arrow key to highlight a drive, then press <Space> to select. A small triangle marks the selected drive. Press <Enter> after completing your selection.

6. Use the up/down arrow key to select the stripe size for the RAID 0 array, then press <Enter>. The available stripe size values range from 4 KB to 128 KB. The default stripe size is 128 KB.



TIP: We recommend a lower stripe size for server systems, and a higher stripe size for multimedia computer systems used mainly for audio and video editing.

7. Key in the RAID volume capacity that you want, then press <Enter>. The default value indicates the maximum allowed capacity.
8. Press <Enter> when the **Create Volume** item is highlighted. This warning message appears.

```
WARNING: ALL DATA ON SELECTED DISKS WILL BE LOST.  
Are you sure you want to create this volume? (Y/N):
```

9. Press <Y> to create the RAID volume and return to the main menu, or <N> to go back to the Create Volume menu.

Creating a RAID 1 set (mirrored)

To create a RAID 1 set:

1. From the utility main menu, select **1. Create RAID Volume**, then press <Enter>. This screen appears.

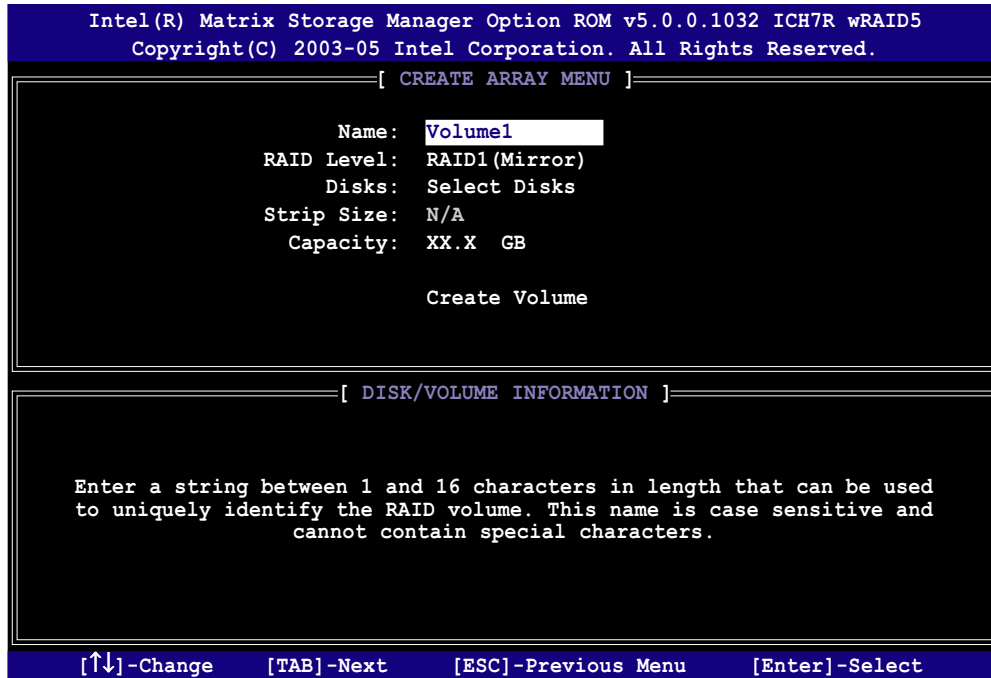

2. Enter a name for the RAID 1 set, then press <Enter>.
3. When the **RAID Level** item is highlighted, press the up/down arrow key to select **RAID 1 (Mirror)**, then press <Enter>.
4. When the **Capacity** item is highlighted, key in the RAID volume capacity that you want, then press <Enter>. The default value indicates the maximum allowed capacity.
5. Press <Enter> when the **Create Volume** item is highlighted. This warning message appears.

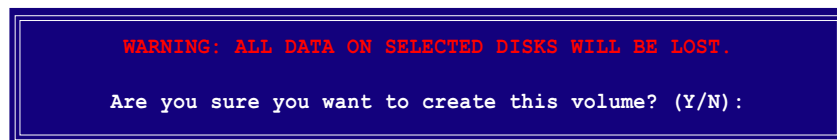

6. Press <Y> to create the RAID volume and return to main menu or <N> to go back to Create Volume menu.

Creating a RAID 10 set (RAID 0+1)

To create a RAID 10 set:

1. From the utility main menu, select **1. Create RAID Volume**, then press <Enter>. This screen appears.

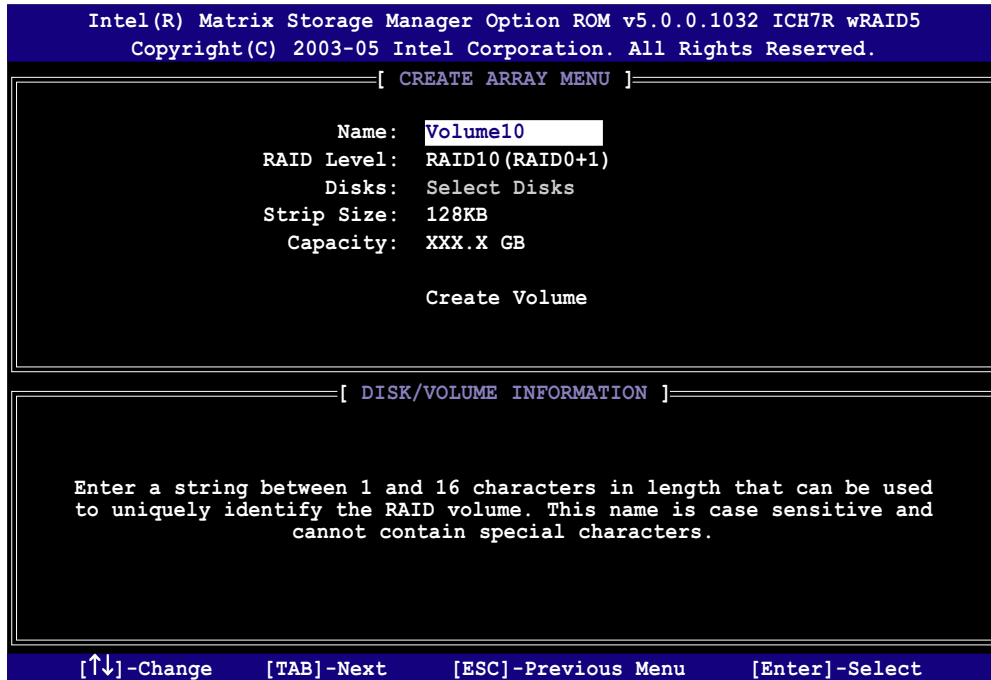

2. Enter a name for the RAID 10 set, then press <Enter>.
3. When the **RAID Level** item is highlighted, press the up/down arrow key to select **RAID 10(RAID0+1)**, then press <Enter>.
4. When the **Stripe Size** item is highlighted, press the up/down arrow key to select the stripe size for the RAID 10 array, then press <Enter>. The available stripe size values range from 4 KB to 128 KB. The default stripe size is 64 KB.



TIP: We recommend a lower stripe size for server systems, and a higher stripe size for multimedia computer systems used mainly for audio and video editing.

5. Key in the RAID volume capacity that you want then press <Enter> when the **Capacity** item is highlighted. The default value indicates the maximum allowed capacity.

6. Press <Enter> when the **Create Volume** item is highlighted. This warning message appears.



7. Press <Y> to create the RAID volume and return to the main menu or <N> to go back to the Create Volume menu.

Creating a RAID 5 set (parity)

To create a RAID 5 set:

1. From the utility main menu, select **1. Create RAID Volume**, then press <Enter>. This screen appears.

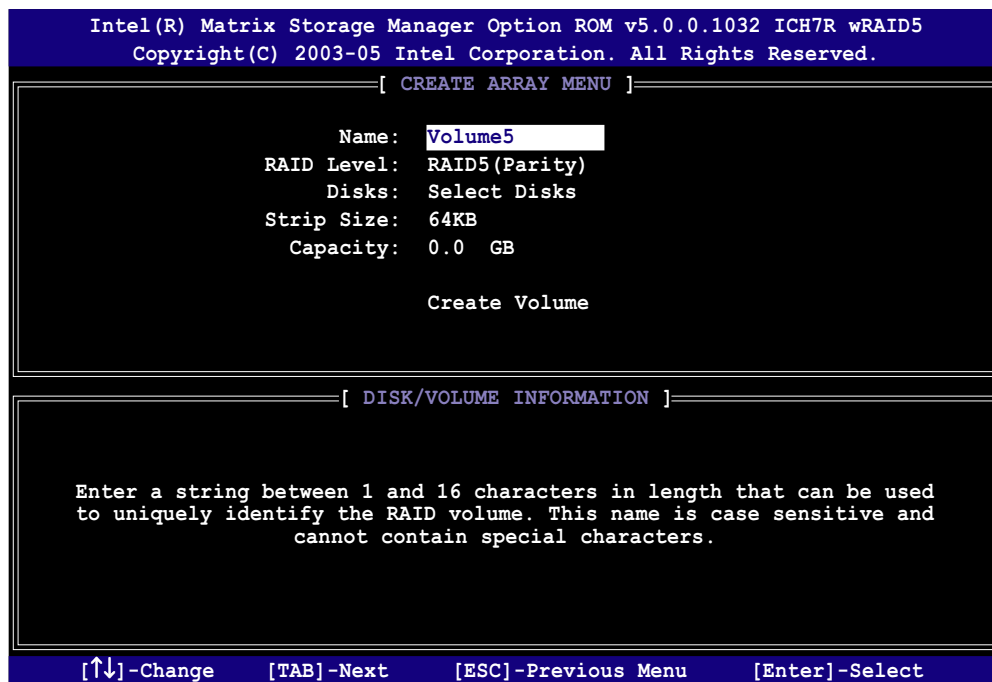

2. Enter a name for the RAID 5 set, then press <Enter>.
3. When the **RAID Level** item is highlighted, press the up/down arrow key to select **RAID 5(Parity)**, then press <Enter>.

- The Disks item is highlighted, press <Enter> to select the hard disk drives to configure as RAID. The following pop-up screen appears.

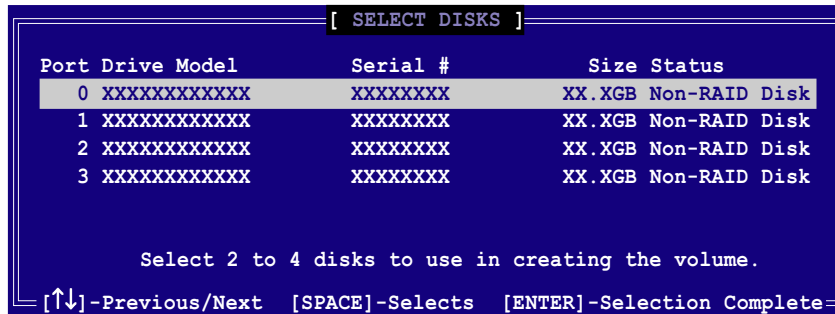

- Use the up/down arrow key to highlight the drive you want to set, then press <Space> to select. A small triangle marks the selected drive. Press <Enter> after completing your selection.
- When the **Stripe Size** item is highlighted, press the up/down arrow key to select the stripe size for the RAID 5 array, then press <Enter>. The available stripe size values range from 4 KB to 128 KB. The default stripe size is 64 KB.



TIP: We recommend a lower stripe size for server systems, and a higher stripe size for multimedia computer systems used mainly for audio and video editing.

- Key in the RAID volume capacity that you want, then press <Enter> when the **Capacity** item is highlighted. The default value indicates the maximum allowed capacity.
- Press <Enter> when the **Create Volume** item is highlighted. This warning message appears.

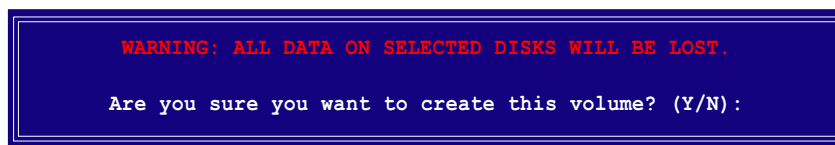

- Press <Y> to create the RAID volume and return to the main menu or <N> to go back to the Create Volume menu.

Deleting a RAID set



Take caution when deleting a RAID set. You will lose all data on the hard disk drives when you delete a RAID set.

To delete a RAID set:

1. From the utility main menu, select **2. Delete RAID Volume**, then press <Enter> to display this screen.

```
Intel(R) Matrix Storage Manager Option ROM v5.0.0.1032 ICH7R wRAID5
Copyright(C) 2003-05 Intel Corporation. All Rights Reserved.

[ DELETE VOLUME MENU ]
-----
Name           Level           Drives      Capacity   Status   Bootable
Volume0        RAIDX (xxxxx)   X           XXX.XGB   Normal   Yes
-----
[ HELP ]
-----

Deleting a volume will destroy the volume data on the drive(s) and
cause any member disks to become available as non-RAID disks.

WARNING: EXISTING DATA WITHIN THIS VOLUME WILL BE LOST AND NON-RECOVERABLE.

[↑↓]-Select      [<ESC>]-Previous Menu      [<Del>]-Delete Volume
```

2. Use the up/down arrow key to select the RAID set you want to delete, then press . This window appears.

```
[ DELETE VOLUME VERIFICATION ]
-----
ALL DATA IN THE VOLUME WILL BE LOST!

Are you sure you want to delete volume "VolumeX"? (Y/N):
```

3. Press <Y> to delete the RAID set and return to the utility main menu; otherwise, press <N> to return to the Delete Volume menu.

Resetting Disks to Non-RAID



Take caution before you reset a RAID volume HDD to non-RAID. Resetting a RAID volume HDD deletes all internal RAID structure on the drive.

To reset a RAID set hard disk drive:

1. From the utility main menu, select **3. Reset Disks to Non-RAID**, then press <Enter> to display this screen.

```
[ RESET RAID DATA ]

Resetting RAID data will remove internal RAID structures
from the selected RAID disks. By removing these structures,
the drive will revert back to a non-RAID disk.

WARNING: Resetting a disk causes all data on the disk to be lost.

Port Drive Model          Serial #          Size Status
---  -  -  -  -  -  -  -  -  -  -  -  -  -  -  -  -  -  -  -  -  -  -
0  XXXXXXXXXXXXX          XXXXXXXX          XX.XGB Member Disk
1  XXXXXXXXXXXXX          XXXXXXXX          XX.XGB Member Disk

Select the disks that should be reset.

[↑↓]-Previous/Next [SPACE]-Selects [ENTER]-Selection Complete
```

2. Use the up/down arrow key to highlight the RAID set drive you want to reset, then press <Space> to select.
3. Press <Enter> to reset the RAID set drive. A confirmation message appears.
4. Press <Y> to reset the drive or press <N> to return to the utility main menu.

Exiting the Intel® Matrix Storage Manager utility

To exit the utility:

1. From the utility main menu, select **4. Exit**, then press <Enter>. This window appears.

```
[ CONFIRM EXIT ]

Are you sure you want to exit? (Y/N):
```

2. Press <Y> to exit or press <N> to return to the utility main menu.

Resetting a RAID set hard disks drive



Take caution before you reset a RAID volume HDD to non-RAID. Resetting a RAID volume HDD deletes all internal RAID structure on the drive.

To reset a RAID set hard disk drive:

1. From the utility main menu, select **[3. Reset Disks to Non-RAID]**, then press <Enter> to display the following screen.

```
          [ RESET RAID DATA ]
Resetting RAID data will remove the internal RAID structures
from the selected RAID disks. By removing these structures
the drive will revert back to a Non-RAID disk.
WARNING: Resetting a disk causes all data on the disk to be lost.
Port Drive Model      Serial #      Size      Status
  0 STXXXXXXXXX      XXXXXXXX    XX.0GB    Member Disk
  1 STXXXXXXXXX      XXXXXXXX    XX.0GB    Member Disk
Select the disk that should be reset
[ ↓↑ ] -Previous/Next  [ Space ] -Selects  [ Enter ] -Selection Complete
```

2. Use the up or down arrow keys to highlight the RAID set drive you want to reset, then press <Space> to select.
3. Press <Enter> to reset the RAID set drive. A confirmation window appears.
4. Press <Y> to reset the drive; otherwise, press <N> to return to the utility main menu.
5. Follow steps 2 to 4 to select and reset other RAID set drives.

5.1.4 LSI Logic Embedded SATA RAID Setup Utility

The LSI Logic Embedded SATA RAID Setup Utility allows you to create RAID 0, RAID 1, and RAID 10 set(s) from SATA hard disk drives connected to the SATA connectors supported by the motherboard Southbridge chip.



The LSI Logic Embedded SATA RAID automatically configures a RAID 1 (Mirrored) set when the **SATA is configured as RAID** in the BIOS and you installed two hard disk drives without a RAID configuration.

To enter the LSI Logic Embedded SATA RAID Setup Utility:

1. Turn on the system after installing all the SATA hard disk drives.
2. During POST, the LSI Logic Embedded SATA RAID Setup Utility automatically detects the installed SATA hard disk drives and displays any existing RAID set(s). Press <Ctrl> + <M> to enter the utility.

```
LSI Logic Embedded SATA RAID BIOS Version 5.4.06091652R
(c)2004 Copyright LSI Logic Corporation. All Rights Reserved.

LSI Logic Embedded SATA RAID Found at PCI Bus No:00 Dev No:1F
Scanning for Port 0 ... Responding. ST380013AS      76319MB      UDMA 6
Scanning for Port 1 ... Responding. ST380013AS      76319MB      UDMA 6
Scanning for Port 2 ... Responding. ST380023AS      76319MB      UDMA 6
Scanning for Port 3 ... Responding. ST380023AS      76319MB      UDMA 6

LSI Logic Embedded SATA RAID Not Configured!

New Drive(s) Found.

Press Ctrl-M to run LSI Logic Embedded SATA RAID Setup Utility.
```



You may also create a RAID set(s) in a Windows® operating environment using the Global Array Manager (GAM) application. Refer to the GAM user guide in the motherboard support CD for details.

- The utility main window appears. Use the arrow keys to select an option from the **Management Menu**, then press <Enter>. Refer to the Management Menu descriptions below.

At the bottom of the screen is the legend box. The keys on the legend box allow you to navigate through the setup menu options or execute commands. The keys on the legend box vary according to the menu level.



Menu	Description
Configure	Allows you to create RAID 0, RAID 1, or RAID 10 set using the Easy Configuration or the New Configuration command. This menu also allows you to view, add, or clear RAID configurations or select the boot drive
Initialize	Allows you to initialize the logical drives of a created RAID set
Objects	Allows you to initialize logical drives or change the logical drive parameters
Rebuild	Allows you to rebuild failed drives
Check Consistency	Allows you to check the data consistency of the logical drives of a created RAID set

Creating a RAID set

The LSI Logic Embedded SATA RAID Setup Utility allows you to create a RAID 0 or RAID 1 set using two types of configurations: **Easy** and **New**.

In **Easy Configuration**, the logical drive parameters are set automatically including the size and stripe size (RAID 1 only).

In **New Configuration**, you manually set the logical drive parameters and assign the set size and stripe size (RAID 1 only).

Using Easy Configuration

To create a RAID set using the **Easy Configuration** option:

1. From the utility main menu, highlight **Configure**, then press <Enter>.
2. Use the arrow keys to select **Easy Configuration**, then press <Enter>.

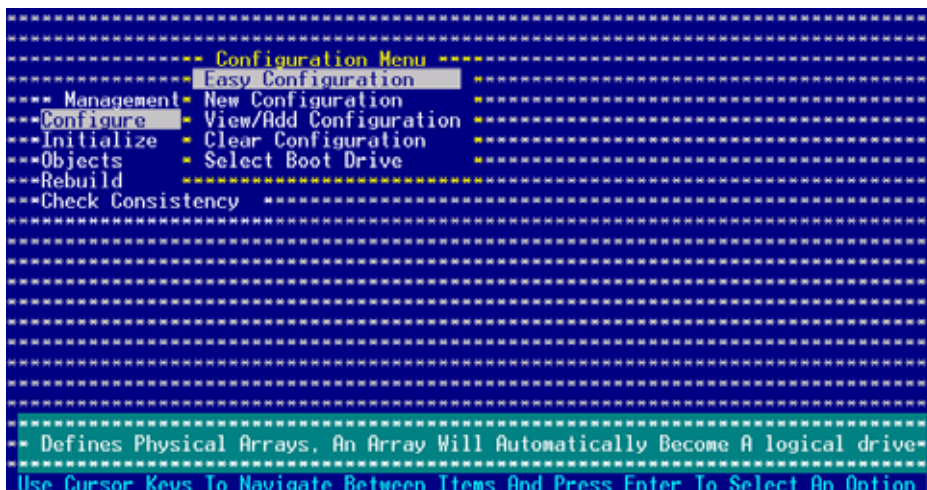

3. The **ARRAY SELECTION MENU** displays the available drives connected to the SATA ports. Select the drives you want to include in the RAID set, then press <SpaceBar>. When selected, the drive indicator changes from **READY** to **ONLIN A[X]-[Y]**, where X is the array number, and Y is the drive number.

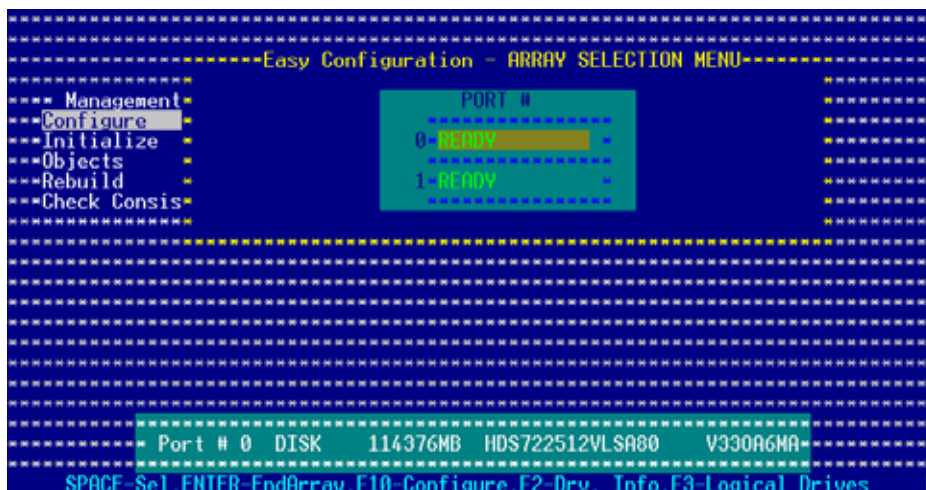

The information of the selected hard disk drive displays at the bottom of the screen.

4. Select all the drives required for the RAID set, then press <Enter>. The configurable array appears on screen.

```

-----Easy Configuration - ARRAY SELECTION MENU-----
* Management *
  Configure
  Initialize
  Objects
  Rebuild
  Check Consis
-----
                                PORT #
                                0- ONLINE 114376MB
                                1- ONLINE 114376MB
-----
Port # 1 DISK 114376MB HDS722512VLSA80 V330A6MA
SPACE- Sel ENTER- EndArray F10- Configure F2- Drv. Info F3- Logical Drives

```

5. Press <F10>, select the configurable array, then press <SpaceBar>.

```

-----Easy Configuration - ARRAY SELECTION MENU-----
-----Select Configurable Array(s)-----
* Management *
  Configure
  Initialize
  Objects
  Rebuild
  Check Consis
-----
                                A-0
                                ONLINE
-----
Cursor Keys SPACE-(De)Select F2-ChdInfo F3-SlotInfo F10-Configure ESC-Quit

```

The logical drive information appears including a Logical Drive menu that allows you to change the logical drive parameters.

```

-----Logical Drive(s) Configured-----
-----
L.D. RAID Size #Stripes StripeSz Status
-----
0 1 114376MB 2 64 KB ONLINE
-----
* Management *
  Configure
  Initialize
  Objects
  Rebuild
  Check Con
-----
-----Logical Drive 0-----
RAID = 1
Size = 114376MB
Stripe Size
Accept
SPAN = NO
-----
Choose RAID Level For This Logical Drive
Use Cursor Keys To Navigate Between Items And Press Enter To Select An Option

```

6. Select **RAID** from the **Logical Drive** menu, then press <Enter>.
7. Select the RAID level from the menu, then press <Enter>.



You need at least two identical hard disk drives when creating a RAID 1 set.

```

***** Logical Drive(s) Configured *****
***** LD  RAID  Size  #Stripes  StripeSz  Status *****
***** 0    1    114376MB  2        64 KB    ONLINE *****
--*-- Managem
--*-- Configure
--*-- Initializ
--*-- Objects
--*-- Rebuild
--*-- Check Con
*****
***** Logical Drive 0 ***** RAID Level *****
***** RAID = 1 ***** RAID 0 *****
***** Size = 114376MB ***** RAID 1 *****
***** Stripe Size *****
***** Accept *****
***** SPAN = NO *****
*****
***** Choose RAID Level For This Logical Drive *****
Use Cursor Keys To Navigate Between Items And Press Enter To Select An Option

```

8. When creating a RAID 1 or a RAID 10 set, select **Stripe Size** from the **Logical Drive** menu, then press <Enter>. When creating a RAID 0 set, proceed to step 10.
9. Key-in the stripe size, then press <Enter>.

```

***** Logical Drive(s) Configured *****
***** LD  RAID  Size  #Stripes  StripeSz  Status *****
***** 0    1    114376MB  2        64 KB    ONLINE *****
--*-- Managem
--*-- Configure
--*-- Initializ
--*-- Objects
--*-- Rebuild
--*-- Check C
***** Enter Stripe Size In KB (4,8,16,32,64,128)? :64 *****
*****
***** Logical Drive 0 *****
***** RAID = 1 *****
***** Size = 114376MB *****
***** Stripe Size *****
***** Accept *****
***** SPAN = NO *****
*****
***** Enter Stripe Size In KB (4,8,16,32,64,128)? :
Use Cursor Keys To Navigate Between Items And Press Enter To Select An Option

```



For server systems, we recommend that you use a lower array block size. For multimedia computer systems used mainly for audio and video editing, we recommend a higher array block size for optimum performance.

- When finished setting the selected logical drive configuration, select **Accept** from the menu, then press <Enter>.

```

***** Logical Drive(s) Configured *****
***** LD RAID Size #Stripes StripeSz Status *****
***** 0 1 114376MB 2 64 KB ONLINE *****
Management
Configure
Initializ
Objects
Rebuild
Check Con
*****

Logical Drive 0
RAID = 1
Size = 114376MB
Stripe Size
Accept
SPAN = NO
*****

Accept This Logical Drive Configuration And Go To Next Logical Drive
Use Cursor Keys To Navigate Between Items And Press Enter To Select An Option
  
```

- When finished setting the selected logical drive configuration, select **Accept** from the menu, then press <Enter>.
- Follow steps 5 to 10 to configure additional logical drives.
- When prompted, save the configuration, then press <Esc> to return to the Management Menu.

```

***** Configuration Menu ***** Save Configuration ? *****
Easy Configuration Yes
New Configuration No
Configure View/Add Configuration
***** Logical Drive(s) Configured *****
***** LD RAID Size #Stripes StripeSz Status *****
***** 0 1 114376MB 2 64 KB ONLINE *****
*****

Select YES Or NO
Use Cursor Keys To Navigate Between Items And Press Enter To Select An Option
  
```



Adding or viewing a RAID configuration

You can add a new RAID configuration or view an existing configuration using the **View/Add Configuration** command.

Adding a new RAID configuration

To add a new RAID configuration:

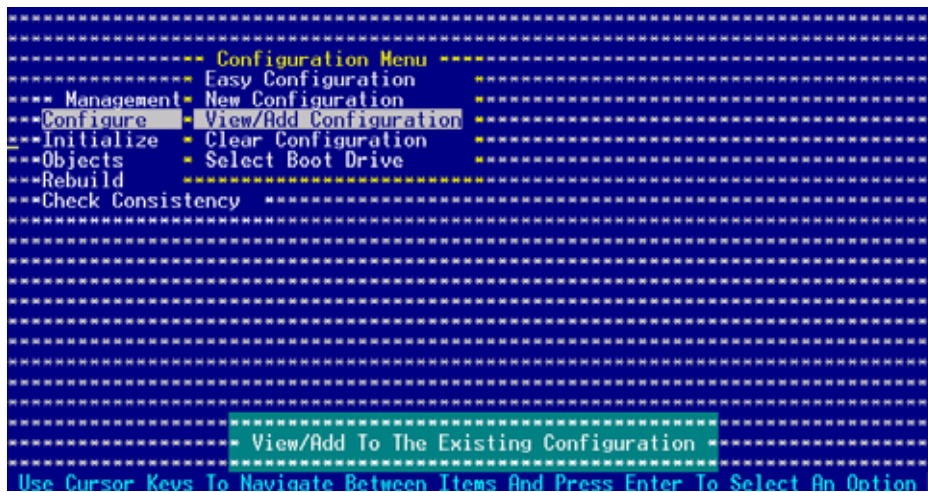
1. From the Management Menu, highlight **Configure**, then press <Enter>.
2. Use the arrow keys to select **View/Add Configuration**, then press <Enter>.



```
----- Configuration Menu -----
----- Easy Configuration -----
Management - New Configuration
Configure - View/Add Configuration
Initialize - Clear Configuration
Objects - Select Boot Drive
Rebuild
Check Consistency
-----
----- View/Add To The Existing Configuration -----
Use Cursor Keys To Navigate Between Items And Press Enter To Select An Option
```

3. The **ARRAY SELECTION MENU** displays the available drives connected to the SATA ports. Select the drive(s) you want to include in the RAID set, then press <SpaceBar>. When selected, the drive indicator changes from **READY** to **ONLIN A[X]-[Y]**, where X is the array number, and Y is the drive number.

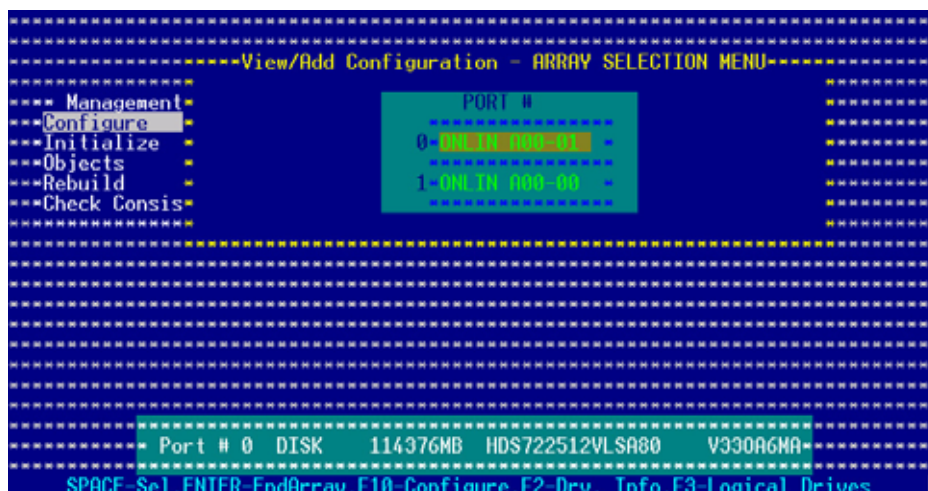

```
-----View/Add Configuration - ARRAY SELECTION MENU-----
Management -
Configure -
Initialize -
Objects -
Rebuild -
Check Consis-
-----
PORT #
0 - READY 1000000000
1 - ONLIN 100 00
-----
Port # 0 DISK 114376MB HDS722512VLSA80 V330A6MA
SPACE-Sel ENTER-EndArray F10-Configure F2-Drv. Info F3-Logical Drives
```



The information of the selected hard disk drive displays at the bottom of the screen.

- Select all the drives required for the RAID set, then press <Enter>. The configurable array appears on screen.

```

*****View/Add Configuration - ARRAY SELECTION MENU*****
Management
Configure
Initialize
Objects
Rebuild
Check Consis
*****
PORT #
0-ONLINE 000-00
1-ONLINE 000-01
*****
Port # 1 DISK 114376MB HDS722512VLSA80 V330A6MA
SPACE-Sel,ENTER-EndArray,F10-Configure,F2-Drv. Info,F3-Logical Drives

```

- Press <F10>, select the configurable array, then press <SpaceBar>.

```

*****View/Add Configuration - ARRAY SELECTION MENU*****
*****Select Configurable Array(s)*****
Management
Configure
Initialize
Objects
Rebuild
Check Consis
*****
A-0
*****
Cursor Keys, SPACE-(De)Select F2-ChIdInfo F3-SlotInfo F10-Configure F5C-Quit

```

The logical drive information appears including a Logical Drive menu that allows you to change the logical drive parameters.

```

***** Logical Drive(s) Configured *****
LD RAID Size #Stripes StripeSz Status
0 1 114376MB 2 64 KB ONLINE
Management
Configure
Initialize
Objects
Rebuild
Check Con
*****
Logical Drive 0
RAID = 1
Size = 114376MB
Stripe Size
Accept
SPAN = NO
*****
Choose RAID Level For This Logical Drive
Use Cursor Keys To Navigate Between Items And Press Enter To Select An Option

```

6. Follow steps 6 to 7 of the **Creating a RAID set: Using Easy Configuration** section.
7. Select **Size** from the **Logical Drive** menu, then press <Enter>.
8. Key-in the desired logical drive size, then press <Enter>.

```

***** Logical Drive(s) Configured *****
***** LD   RAID   Size   #Stripes   StripeSz   Status *****
***** 0     1     114376MB  2          64 KB      ONLINE *****
*** Manage *****
** Configure *****
** Initialize *****
** Objects *****
** Rebuild *****
** Check C *****
*****
***** Enter Logical Drive Size (MB) :114376 *****
*****
***** Logical Drive 0 *****
***** RAID = 1 *****
***** Size = 114376MB *****
***** Stripe Size *****
***** Accept *****
***** SPAN = NO *****
*****
***** Enter Logical Drive Size (MB) : *****
*****
Use Cursor Keys To Navigate Between Items And Press Enter To Select An Option

```

9. Follow steps 8 to 13 of the **Creating a RAID set: Using Easy Configuration** section to add the new RAID configuration.

Initializing the logical drives

After creating the RAID set(s), you must initialize the logical drives. You may initialize the logical drives of a RAID set(s) using the **Initialize** or **Objects** command on the Management Menu.

Using the Initialize command

To initialize the logical drive using the **Initialize** command:

1. From the Management Menu, highlight **Initialize**, then press <Enter>.

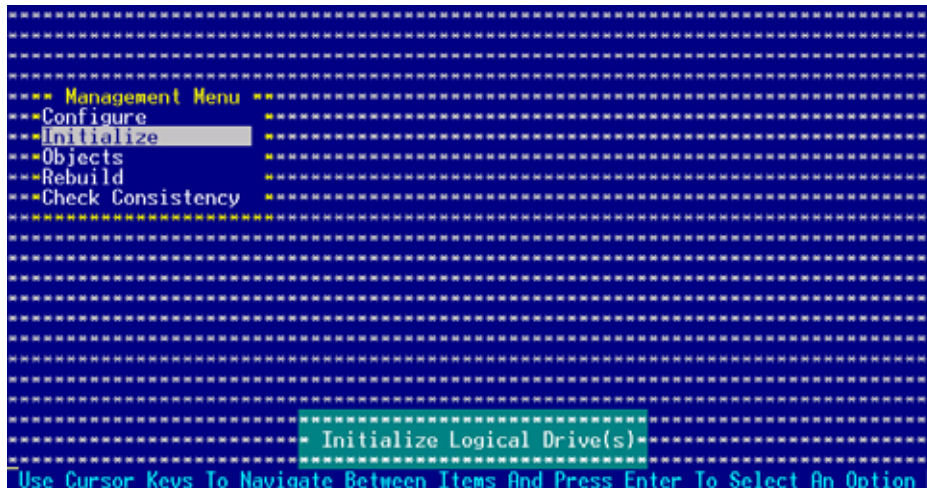

2. The screen displays the available RAID set(s) and prompts you to select the logical drive to initialize. Use the arrow keys to select the logical drive from the **Logical Drive** selection, then press <Enter>.

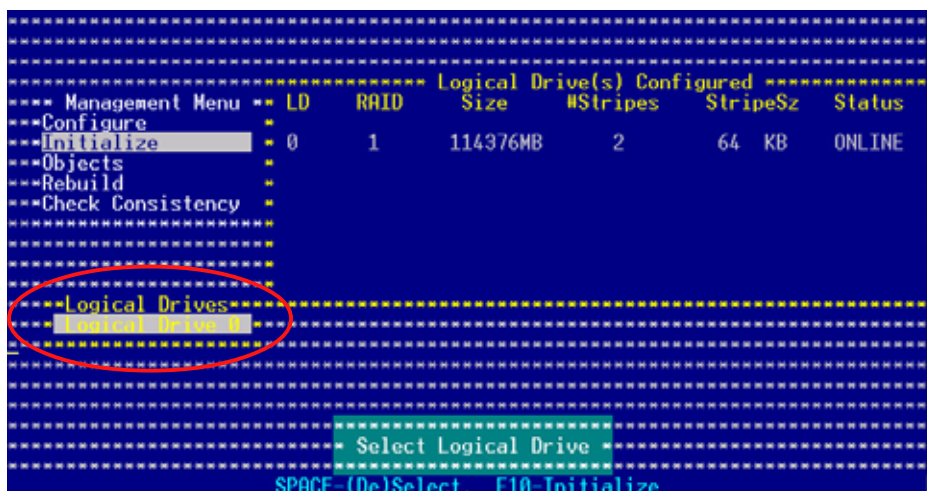

- When prompted, press the <SpaceBar> to select **Yes** from the **Initialize?** dialog box, then press <Enter>. You may also press <F10> to initialize the drive without confirmation.

```
.....
.....
***** Logical Drive(s) Configured *****
--- Management Menu --- LD  RAID  Size  #Stripes  StripeSz  Status
--- Configure
--- Initialize  *  0  1  114376MB  2  64 KB  ONLINE
--- Objects
--- Rebuild
--- Check Consistency
*****
***** Initialize ?*****
--- Yes
--- No
*****
--- Logical Drives
-----
***** Initialize Will Destroy Data On Selected Logical Drive(s). *****
SPACE-(De)Select, F10-Initialize
```



Initializing a logical drive(s) erases all data on the drive.

- A progress bar appears on screen. If desired, press <Esc> to abort initialization.

```
.....
.....
***** Logical Drive(s) Configured *****
--- Management Menu --- LD  RAID  Size  #Stripes  StripeSz  Status
--- Configure
--- Initialize  *  0  1  114376MB  2  64 KB  ONLINE
--- Objects
--- Rebuild
--- Check C
*****
***** Initialize Logical Drives In Progress*****
***** Array Initialization Under Progress. Press ESC to ABORT *****
*****
***** = 16 % Completed *****
--- Logica
-----
***** Initialize Will Destroy Data On Selected Logical Drive(s). *****
SPACE-(De)Select, F10-Initialize
```

Rebuilding failed drives

You can manually rebuild failed hard disk drives using the **Rebuild** or **Objects** command in the Management Menu.

Using the Rebuild command

To rebuild a failed hard disk drive using the **Rebuild** command:

1. From the Management Menu, highlight **Rebuild**, then press <Enter>.



2. The **PHYSICAL DRIVES SELECTION MENU** displays the available drives connected to the SATA ports. Select the drive you want to rebuild, then press <SpaceBar>.

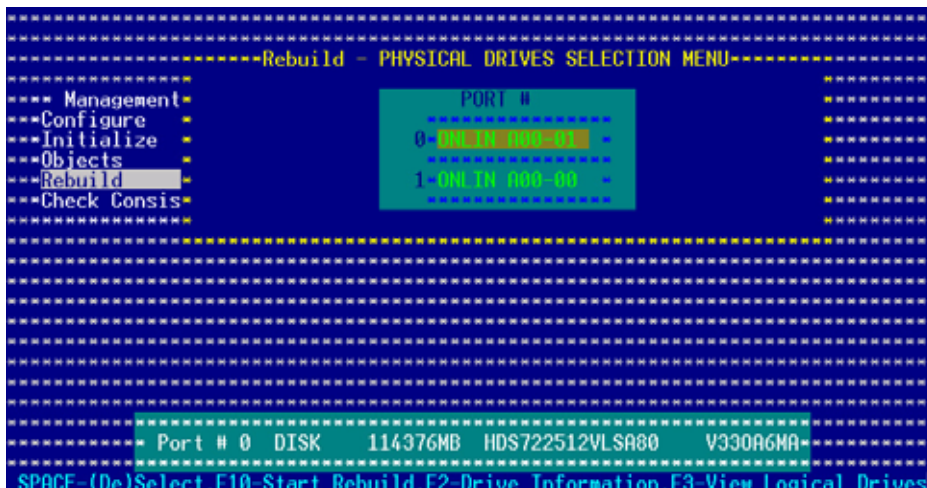

3. After selecting the drive to rebuild, press <F10>. The indicator for the selected drive now shows **RBLD**.

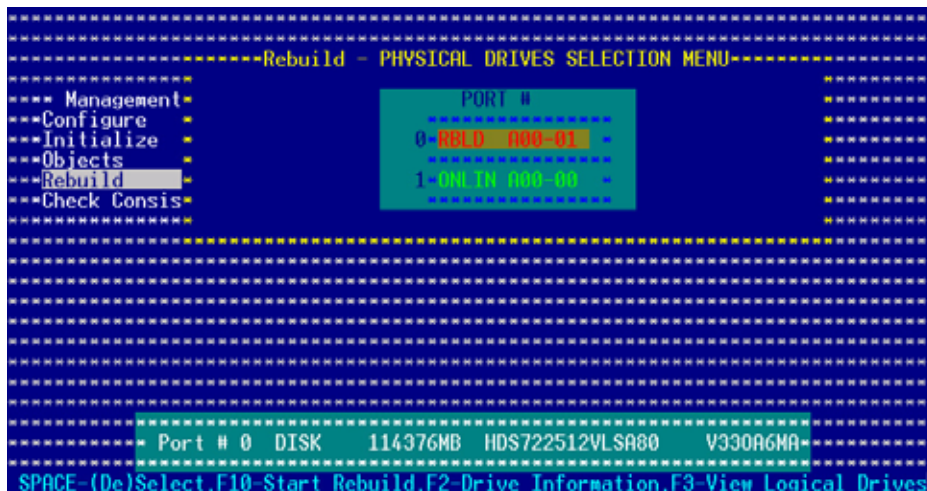

4. When prompted, press <Y> to to rebuild the drive.

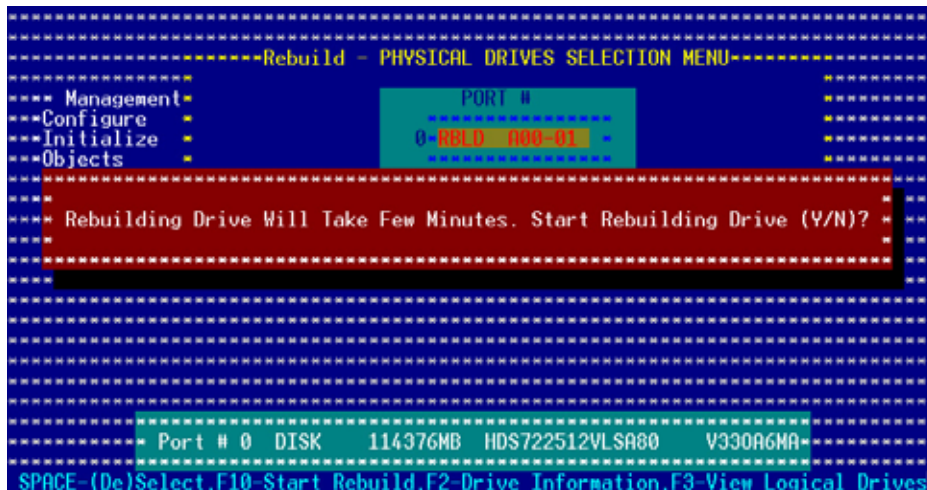

5. When rebuild is complete, press any key to continue.

Using the Objects command

To rebuild a failed hard disk drive using the **Objects** command:

1. From the Management Menu, select **Objects**, then select **Physical Drive** from the menu.
2. Use the arrow keys to select the physical drive you want to rebuild, then press <Enter>.
3. Select **Rebuild** from the pop-up menu, then press <Enter>.
4. When prompted, press <Y> to to rebuild the drive.
5. When rebuild is complete, press any key to continue.

- When prompted, press the <SpaceBar> to select **Yes** from the **Consistency Check** dialog box, then press <Enter>. You may also press <F10> to check the drive consistency.

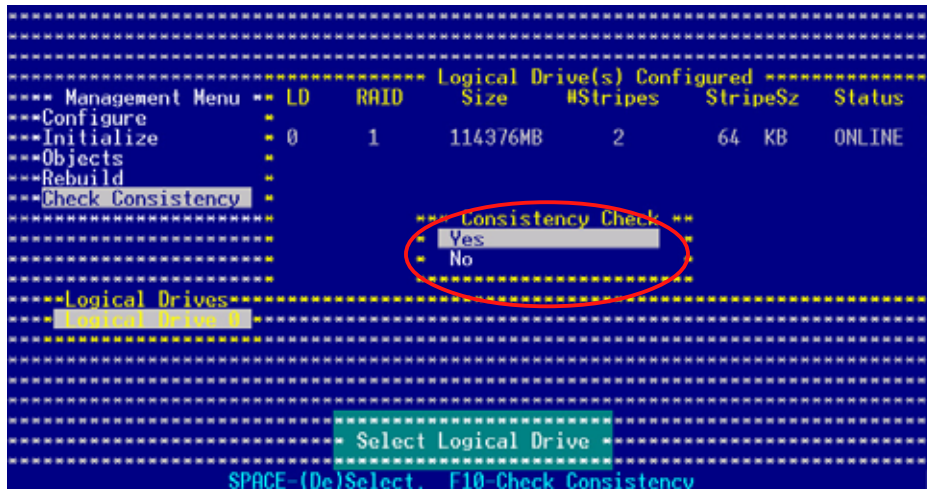

A progress bar appears on screen.

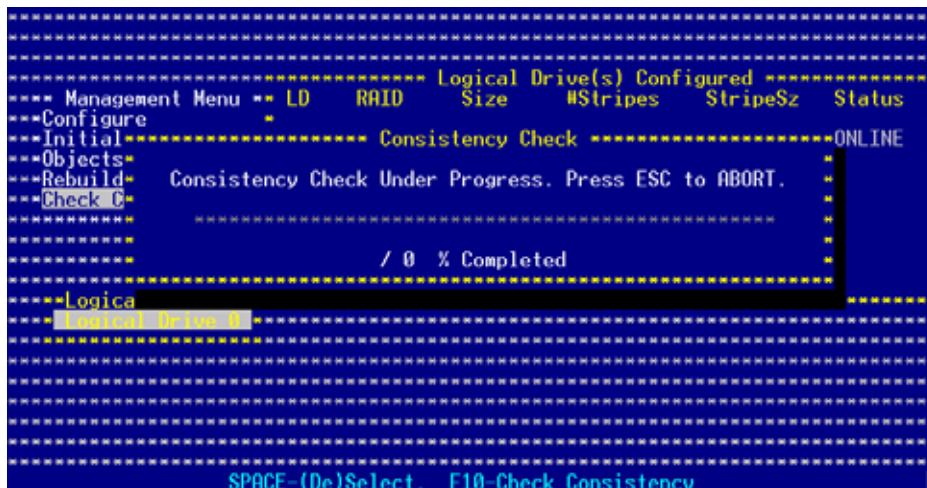

- While checking the disk consistency, press <Esc> to display the following options.
 - Stop - Stops the consistency check. The utility stores the percentage of disk checked, When you restart checking, it continues from the last percentage completed rather than from zero percent.
 - Continue - Continues the consistency check.
 - Abort - Aborts the consistency check. When you restart checking, it continues from zero percent.
- When checking is complete, press any key to continue.

Using the Objects command

To check data consistency using the **Objects** command:

1. From the Management Menu, select **Objects**, then select **Logical Drive** from the menu.
2. Use the arrow keys to select the logical drive you want to check, then press <Enter>.
3. Select **Check Consistency** from the pop-up menu, then press <Enter>.
4. When prompted, press <Y> to to check the drive.
5. When checking is complete, press any key to continue.

Deleting a RAID configuration

To delete a RAID configuration:

1. From the Management Menu, select **Configure > Clear Configuration**, then press <Enter>.

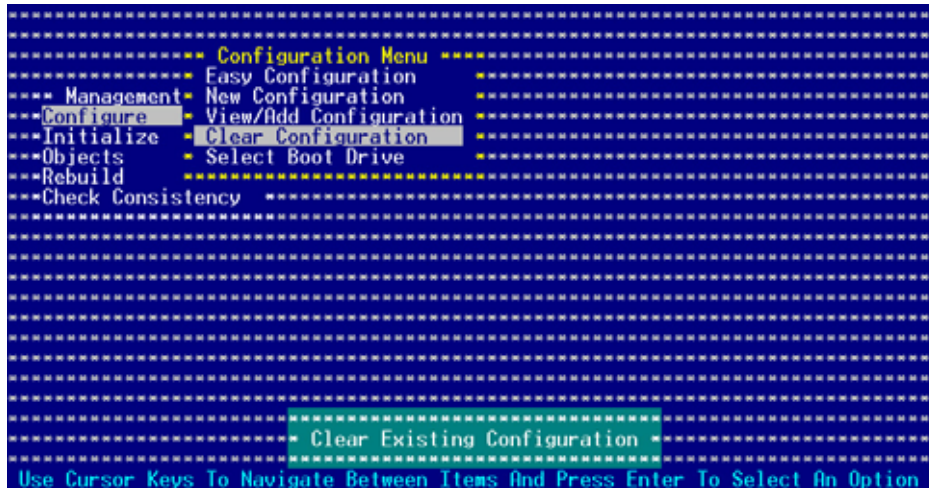

2. When prompted, press the <SpaceBar> to select **Yes** from the **Clear Configuration?** dialog box, then press <Enter>.

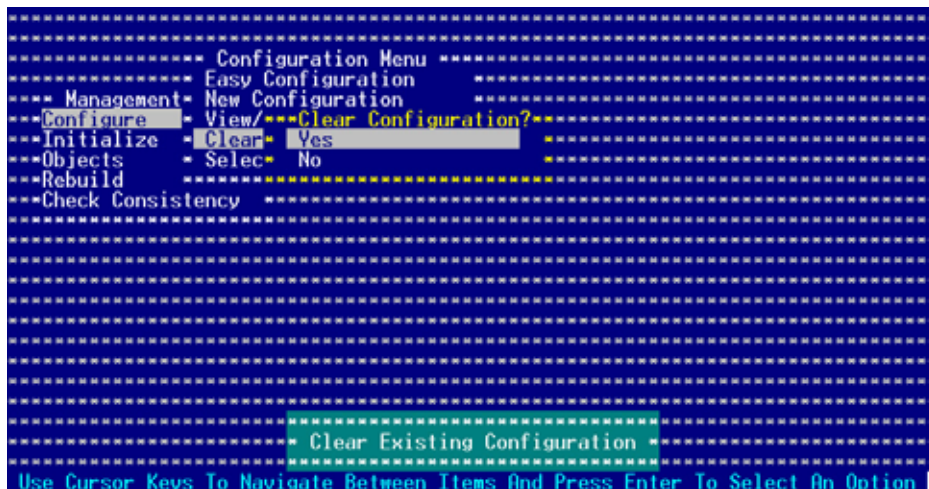

The utility clears the current array.

3. Press any key to continue.

Selecting the boot drive from a RAID set

You must have created a new RAID configuration before you can select the boot drive from a RAID set. Refer to the **Creating a RAID set: Using New Configuration** section for details.

To select the boot drive from a RAID set:

1. From the Management Menu, select **Configure > Select Boot Drive**, then press <Enter>.

```
----- Configuration Menu -----
----- Easy Configuration -----
Management New Configuration
Configure View/Add Configuration
Initialize Clear Configuration
Objects Select Boot Drive
Rebuild
Check Consistency
-----

----- Specify A Logical Drive As Boot Drive On This Adapter -----
Use Cursor Keys To Navigate Between Items And Press Enter To Select An Option
```

2. When prompted, press the <SpaceBar> to select the bootable logical drive from the list, then press <Enter>.

```
----- Bootable Logical Drives (4): Currently (0) -----
Config Boot Drive 0
Easy Co Boot Drive 1
Management New Con Boot Drive 2
Configure View/Ad Boot Drive 3
Initialize Clear C
Objects Select Boot Drive
Rebuild
Check Consistency
-----

----- Specify A Logical Drive As Boot Drive On This Adapter -----
Use Cursor Keys To Navigate Between Items And Press Enter To Select An Option
```

3. The logical drive is selected as boot drive. Press any key to continue.

This chapter provides information on RAID, LAN and VGA driver installation for this motherboard.

Driver installation



Chapter summary



6.1	RAID driver installation	6-1
6.2	LAN driver installation	6-7
6.3	VGA driver installation	6-11

6.1 RAID driver installation

6.1.1 Creating a RAID driver disk

A floppy disk with the RAID driver is required when installing Windows® 2000/XP operating system on a hard disk drive that is included in a RAID set. You can create a RAID driver disk in DOS (using FreeDOS from the support CD) or in Windows® environment.

DOS

To create a RAID driver disk in DOS environment:

1. Place the motherboard support CD in the optical drive.
2. Restart the computer, then enter the BIOS Setup.
3. Set the optical drive as the first boot priority to boot from the support CD. Save your changes, then exit the BIOS Setup.
4. Restart the computer. The following screen appears during POST.

```
a) FreeDOS command prompt
b) Create ICH7R LSI MegaRAID IDE Driver for RHEL4 Driver Disk
c) Create ICH7R LSI MegaRAID IDE Driver for RHEL4 64 bit Driver Disk
d) Create ICH7R LSI MegaRAID IDE Driver for SLES9 SP1 Driver Disk
e) Create ICH7R LSI MegaRAID IDE Driver for SLES9 SP1 64 bit Driver Disk
f) Create ICH7R LSI MegaRAID IDE Driver for SUSE93 Driver Disk
g) Create ICH7R LSI MegaRAID IDE Driver for Win 32/64 bit Driver Disk
h) Create ICH7R Intel Matrix Storage for Win32 driver disk
i) Create ICH7R Intel Matrix Storage for Win64 driver disk
j) Create LSI Logic Fusion-MPT MiniPort for Win2K 32 bit driver
k) Create LSI Logic Fusion-MPT MiniPort for Win2K3 32/64 bit driver
l) Create LSI Logi Fusion-MPT MiniPort for RH3.0AS driver
m) Broadcom Firmware Update
Please choose a ~ m: _
```

5. Place a blank, high-density floppy disk to the floppy disk drive, then press the letter of your choice. The following warning message will appear:

```
Warning!!!
Bootable CD will delete all data in floppy
Press a key to continue.
```

6. Press any key to continue. The RAID drivers are copied to the floppy disk.
7. Eject the floppy disk, then write-protect it to prevent computer virus infection.
8. Press any key to continue.

Windows® 2000/2003 Server

To create a RAID driver disk in Windows® 2000/2003 Server environment:

1. Restart the system from the hard disk drive, then place the system/motherboard support CD in the optical drive.
2. Browse the contents of the support CD to locate the driver disk utility. The 32-bit OS RAID driver disk for the Intel® ICH7R is located in:

\Drivers\Chipset\ICH\Intel\Driver\Makedisk\F6flpy32

The 64-bit OS RAID driver disk for the Intel® ICH7R is located in:

\Drivers\Chipset\ICH\Intel\Driver\Makedisk\F6flpy64

3. Insert a formatted high-density floppy disk to the floppy disk drive.
4. Follow screen instructions to complete the process.
5. After creating a RAID driver disk, eject the floppy disk, then write-protect it to prevent computer virus infection.

6.1.2 Installing the Intel® ICH7R RAID controller driver

Windows® 2000/2003 Server OS

During Windows® 2000/2003 Server OS installation

To install the Intel® ICH7R RAID controller driver when installing Windows® 2000/2003 Server OS:

1. Boot the computer using the Windows® 2000/2003 Server installation CD. The **Windows® 2000/2003 Setup** starts.

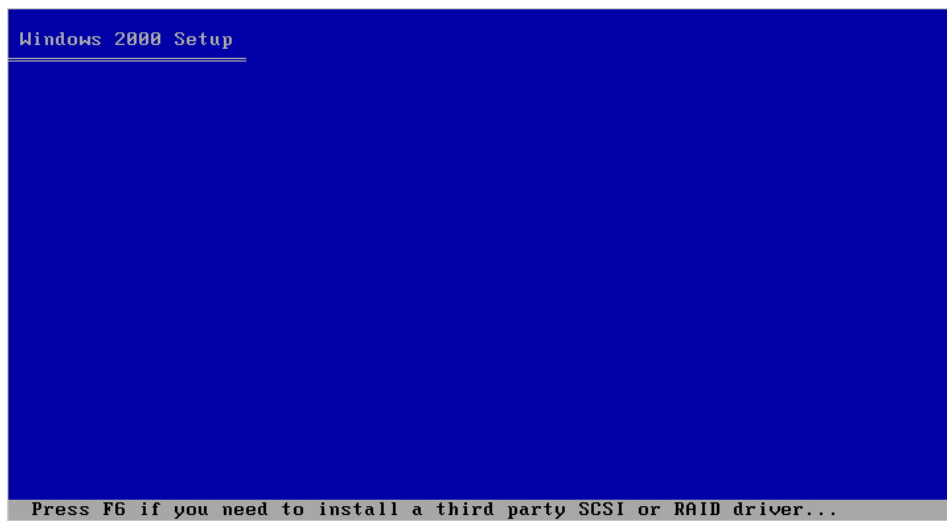

2. Press <F6> when the message “**Press F6 if you need to install a third party SCSI or RAID driver...**” appears at the bottom of the screen.
3. When prompted, press <S> to specify an additional device.

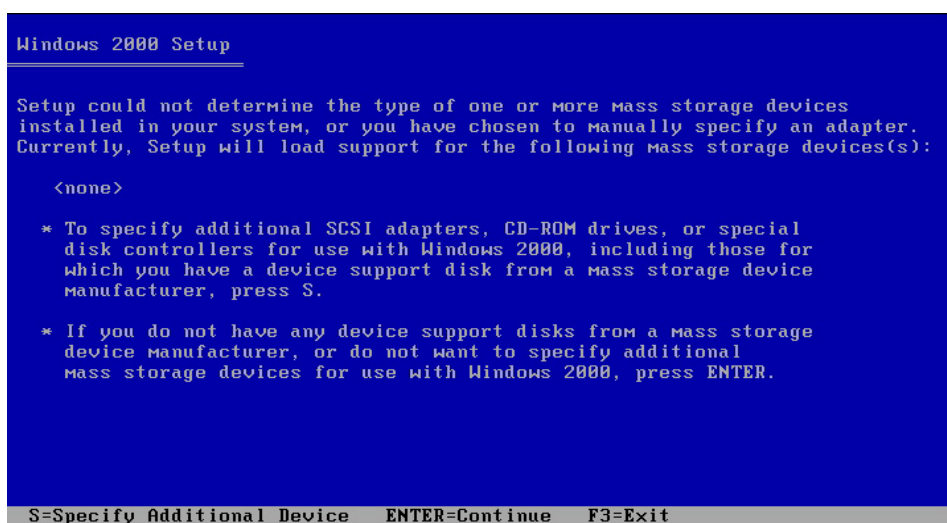

4. Insert the Intel® ICH7R RAID driver disk you created earlier to the floppy disk drive, then press <Enter>.

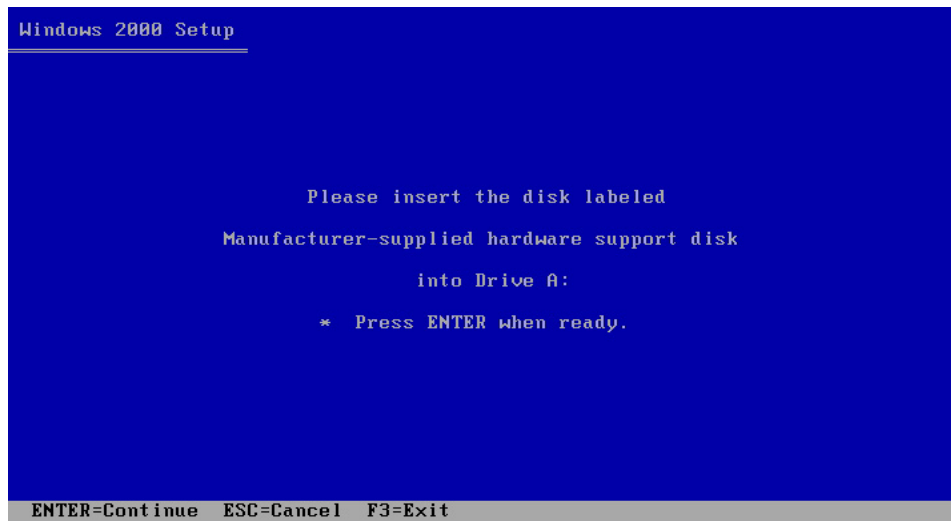

5. Select the **Intel(R) 82801FR SATA RAID Controller (Desktop ICH7R)** from the options, then press <Enter> to select.

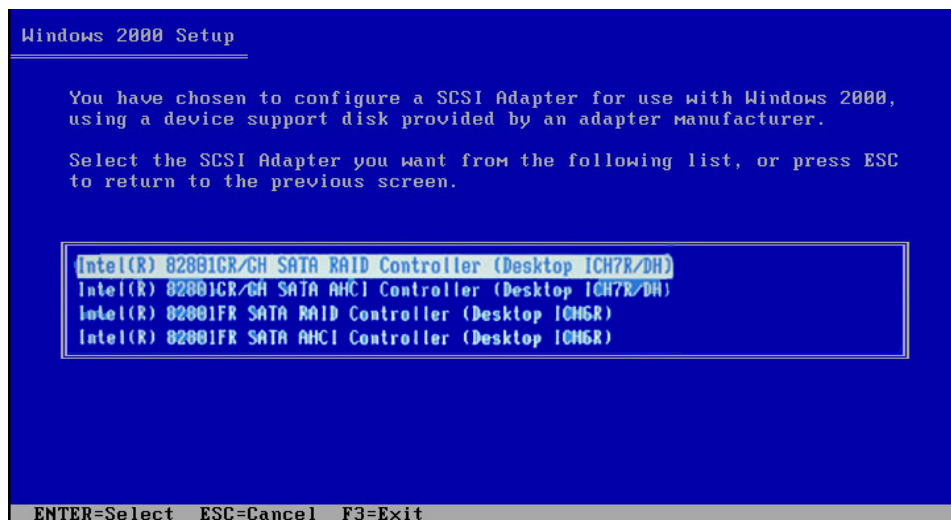

6. The Windows® 2000/2003 Setup loads the RAID controller drivers from the RAID driver disk. When prompted, press <Enter> to continue installation.
7. Setup then proceeds with the OS installation. Follow screen instructions to continue.

To an existing Windows® 2000/2003 Server OS

To install the Intel® ICH7R RAID controller driver on an existing Windows® 2000/2003 Server OS:

1. Restart the computer, then log on with **Administrator** privileges.
2. Windows® automatically detects the RAID controller and displays a **New Hardware Found** window. Click **Cancel**.
3. Right-click the **My Computer** icon on the Windows® desktop , then select **Properties** from the menu.
4. Click the **Hardware** tab, then click the **Device Manager** button to display the list of devices installed in the system.

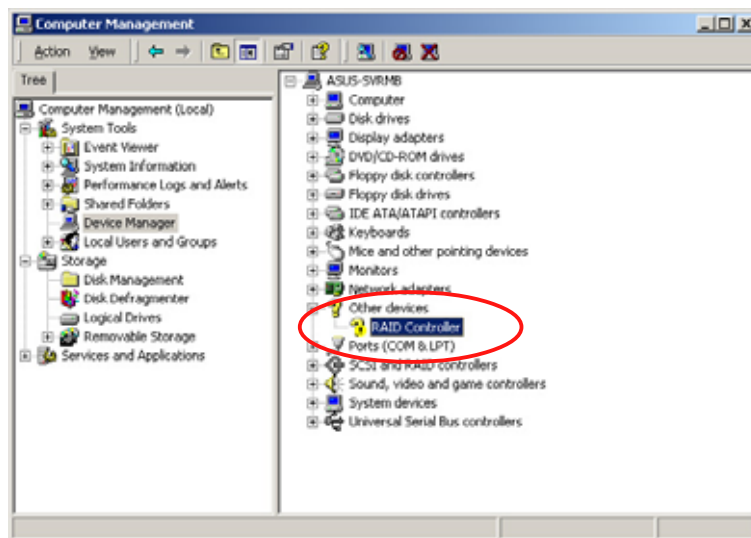

5. Right-click the **RAID controller** item, then select **Properties**.
6. Click the **Driver** tab, then click the **Update Driver** button.
7. The **Upgrade Device Driver Wizard** window appears. Click **Next**.
8. Insert the RAID driver disk you created earlier to the floppy disk drive.
9. Select the option “**Search for a suitable driver for my device (recommended)**”, then click **Next**.
10. The wizard searches the RAID controller drivers. When found, click **Next** to install the drivers.

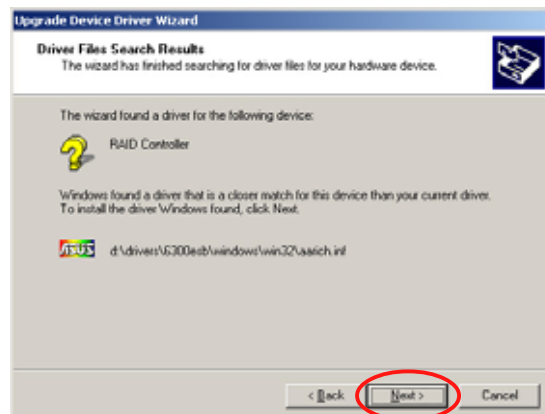

11. Click **Finish** after the driver installation is done.

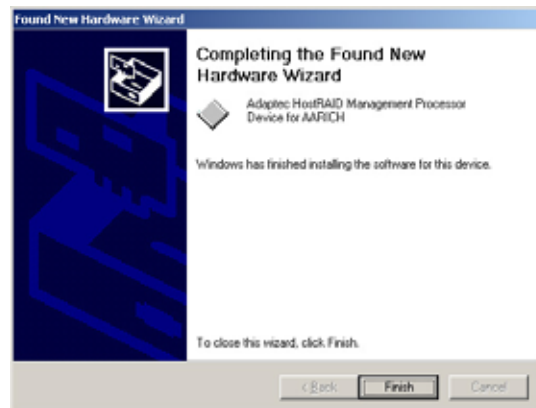

To verify the Intel® ICH7R RAID controller driver installation:

1. Right-click the **My Computer** icon on the Windows® desktop , then select **Properties** from the menu.
2. Click the **Hardware** tab, then click the **Device Manager** button.
3. Click the “+” sign before the item **IDE ATA/ATAPI controllers**.
The **Intel(R) 82801FB Ultra ATA Storage Controllers-2652** item should appear.

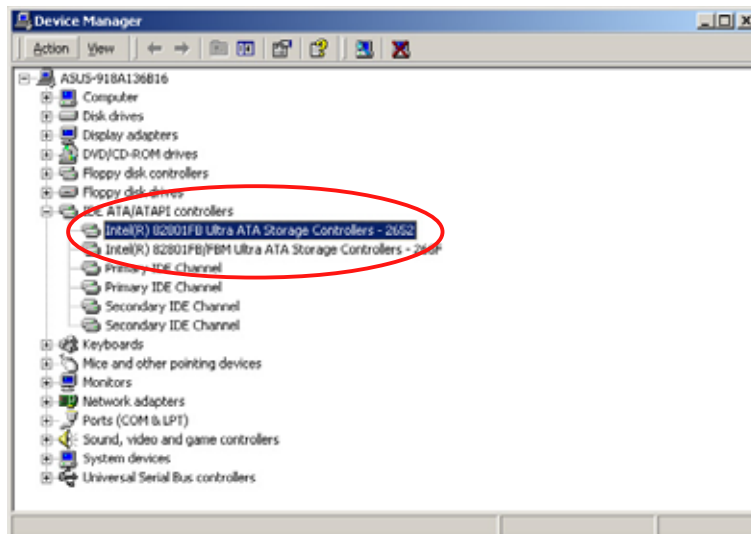

4. Right-click the **Intel(R) 82801FB Ultra ATA Storage Controllers-2652** item, then select **Properties** from the menu.
5. Click the **Driver** tab, then click the **Driver Details** button to display the RAID controller drivers.
6. Click **OK** when finished.

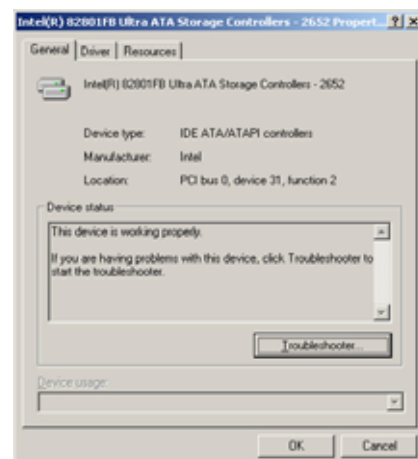

6.2 LAN driver installation

This section provides instructions on how to install the Broadcom® Gigabit LAN controller drivers.

6.2.1 Windows® 2000/2003 Server

To install the Broadcom® Gigabit LAN controller driver on a Windows® 2000/2003 Server OS:

1. Restart the computer, then log on with **Administrator** privileges.
2. Insert the motherboard/system support CD to the optical drive. The CD automatically displays the **Drivers** menu if Autorun is enabled in your computer.



-
- Windows® automatically detects the LAN controllers and displays a **New Hardware Found** window. Click **Cancel** to close this window.
 - If **Autorun** is NOT enabled in your computer, browse the contents of the support CD to locate the file ASSETUP.EXE from the BIN folder. Double-click the **ASSETUP.EXE** to run the CD.
-

3. Click the **Broadcom 5721 LAN Driver** option to begin installation.

4. Click **Next** when the InstallShield Wizard window appears. Follow screen instructions to continue installation.

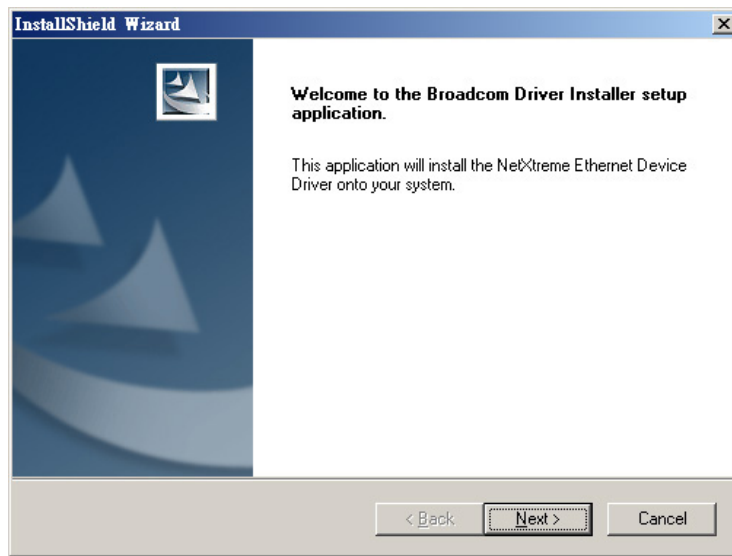

6.2.2 Red Hat® Linux 9.0

Follow these instructions when installing the Broadcom® Gigabit LAN controller base driver for the Red Hat® Linux version 5.2.x operating system. The following procedures were tested for 2.4.x kernels through 2.4.20.

Installing the source RPM package

To install the source RPM package:

1. Install the source RPM package:

```
rpm -ivh bcm5700-<version>.src.rpm
```

2. Change the directory to the RPM path and build the binary driver for your kernel:

```
cd /usr/src/{redhat,OpenLinux,turbo,packages,rpm ..}  
rpm -bb SPECS/bcm5700.spec or rpmbuild -bb SPECS/  
bcm5700.spec
```



The RPM path is different for different Linux distributions.

3. Install the newly built package (driver and man page):

```
rpm -ivh RPMS/i386/bcm5700-<version>.i386.rpm
```



You need the force option when installing the driver on some distributions that has an older version of the driver.

For **2.2.x kernels**, the driver is installed in:

```
/lib/modules/<kernel_version>/net/bcm5700.o
```

For **2.4.x kernels**, the driver is installed in:

```
/lib/modules/<kernel_version>/kernel/drivers/net/  
bcm5700.o
```

For **2.4.x kernels with bcm5700 driver patched in**, the driver is installed in:

```
/lib/modules/<kernel_version>/kernel/drivers/net/bcm/  
bcm5700.o
```

or

```
/lib/modules/<kernel_version>/kernel/drivers/addon/  
bcm5700/bcm5700.o
```

4. Load the driver:

```
insmod bcm5700
```
5. Refer to Linux distribution documentation to configure the network protocol and address.

Building the driver from the TAR file

To build the driver from the TAR file:

1. Create a directory and extract the TAR files:
`tar xvzf bcm5700-<version>.tar.gz`
2. Build the driver `bcm5700.o` as a loadable module for the running kernel:
`cd bcm5700-<version>/src`
`make`
3. Test the driver by loading it:
`insmod bcm5700.o`
4. Install the driver and man page:
`make install`



See the RPM instructions on the previous page for the location of the installed driver.

5. Refer to Linux distribution documentation to configure the network protocol and address.

6.3 VGA driver installation

This section provides instructions on how to install the ATI® RAGE XL Video Graphics Adapter (VGA) driver.

6.3.1 Windows® 2000 Server

You need to manually install the ATI® RAGE XL VGA driver on a Windows® 2000 Server operating system.

To install the ATI® RAGE XL VGA driver:

1. Restart the computer, then log on with **Administrator** privileges.
2. Insert the motherboard/system support CD to the optical drive. The support CD automatically displays the **Drivers** menu if Autorun is enabled in your computer.



Windows® automatically detects the LAN controller and displays a **New Hardware Found** window. Click **Cancel** to close this window.

3. Click the item **ATI Rage XL Display Driver** from the **Drivers** menu.
4. The **ATI Windows 2000 Driver** window appears. Click **Next**. Follow screen instructions to complete installation.



6.3.2 Windows® 2003 Server

The Windows® 2003 Server operating system automatically recognizes the ATI® RAGE XL VGA driver during system installation. There is no need to install an additional driver(s) to support the onboard VGA.

Verifying the VGA driver installation

To verify if the ATI® RAGE XL VGA drivers are properly installed in a Windows® 2000/2003 Server operating system:

1. Right-click the **My Computer** icon on the Windows® desktop, then select **Properties** from the menu.
2. Click the **Hardware** tab, then click the **Device Manager** button.
3. Click the “+” sign before the item **Display adapters**.
The **ATI Technologies Inc. RAGE XL PCI** item should appear.

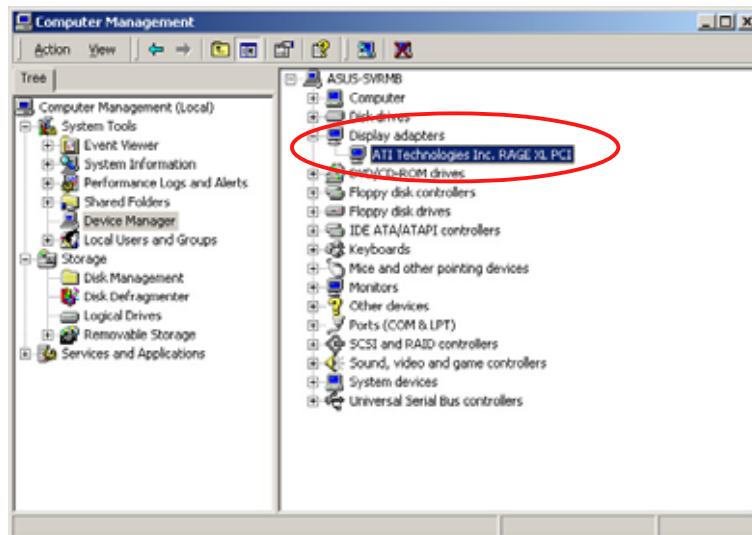

4. Right-click the **ATI Technologies Inc. RAGE XL PCI** item, then select **Properties** from the menu.
5. Click the **Driver** tab, then click the **Driver Details** button to display the VGA drivers.
6. Click **OK** when finished.

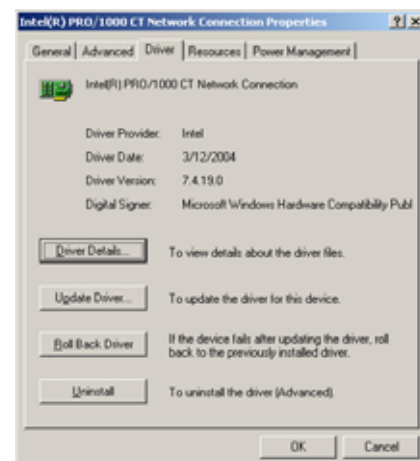

6.3.3 Red Hat® Linux 9.0

The Red Hat® Linux 9.0 (2.4.x kernels) operating system automatically recognizes the ATI® RAGE XL VGA driver during system installation. There is no need to install an additional driver(s) to support the onboard VGA.

The appendix includes additional information that you may refer to when configuring the motherboard.

Reference information



Appendix summary



A.1	P5MT-M block diagram	A-1
-----	----------------------------	-----

A.1 P5MT-M block diagram

