

P5ND2-SLI
Deluxe

ASUS[®]

Motherboard

E2067

**Revised Edition V2
April 2005**

Copyright © 2005 ASUSTeK COMPUTER INC. All Rights Reserved.

No part of this manual, including the products and software described in it, may be reproduced, transmitted, transcribed, stored in a retrieval system, or translated into any language in any form or by any means, except documentation kept by the purchaser for backup purposes, without the express written permission of ASUSTeK COMPUTER INC. ("ASUS").

Product warranty or service will not be extended if: (1) the product is repaired, modified or altered, unless such repair, modification or alteration is authorized in writing by ASUS; or (2) the serial number of the product is defaced or missing.

ASUS PROVIDES THIS MANUAL "AS IS" WITHOUT WARRANTY OF ANY KIND, EITHER EXPRESS OR IMPLIED, INCLUDING BUT NOT LIMITED TO THE IMPLIED WARRANTIES OR CONDITIONS OF MERCHANTABILITY OR FITNESS FOR A PARTICULAR PURPOSE. IN NO EVENT SHALL ASUS, ITS DIRECTORS, OFFICERS, EMPLOYEES OR AGENTS BE LIABLE FOR ANY INDIRECT, SPECIAL, INCIDENTAL, OR CONSEQUENTIAL DAMAGES (INCLUDING DAMAGES FOR LOSS OF PROFITS, LOSS OF BUSINESS, LOSS OF USE OR DATA, INTERRUPTION OF BUSINESS AND THE LIKE), EVEN IF ASUS HAS BEEN ADVISED OF THE POSSIBILITY OF SUCH DAMAGES ARISING FROM ANY DEFECT OR ERROR IN THIS MANUAL OR PRODUCT.

SPECIFICATIONS AND INFORMATION CONTAINED IN THIS MANUAL ARE FURNISHED FOR INFORMATIONAL USE ONLY, AND ARE SUBJECT TO CHANGE AT ANY TIME WITHOUT NOTICE, AND SHOULD NOT BE CONSTRUED AS A COMMITMENT BY ASUS. ASUS ASSUMES NO RESPONSIBILITY OR LIABILITY FOR ANY ERRORS OR INACCURACIES THAT MAY APPEAR IN THIS MANUAL, INCLUDING THE PRODUCTS AND SOFTWARE DESCRIBED IN IT.

Products and corporate names appearing in this manual may or may not be registered trademarks or copyrights of their respective companies, and are used only for identification or explanation and to the owners' benefit, without intent to infringe.

Contents

| | |
|-----------------------------------------------|------|
| Notices | vii |
| Safety information | viii |
| About this guide | ix |
| P5ND2-SLI Deluxe specifications summary | xi |

Chapter 1: Product introduction

| | | |
|-------|--------------------------------|-----|
| 1.1 | Welcome! | 1-1 |
| 1.2 | Package contents | 1-1 |
| 1.3 | Special features | 1-2 |
| 1.3.1 | Product highlights | 1-2 |
| 1.3.2 | ASUS AI features | 1-6 |
| 1.3.3 | Innovative ASUS features | 1-7 |

Chapter 2: Hardware information

| | | |
|-------|---------------------------------------------|------|
| 2.1 | Before you proceed | 2-1 |
| 2.2 | Motherboard overview | 2-2 |
| 2.2.1 | Placement direction | 2-2 |
| 2.2.2 | Screw holes | 2-2 |
| 2.2.3 | Motherboard layout | 2-3 |
| 2.2.4 | Layout contents | 2-4 |
| 2.3 | Central Processing Unit (CPU) | 2-6 |
| 2.3.1 | Installing the CPU | 2-7 |
| 2.3.2 | Installing the CPU heatsink and fan | 2-9 |
| 2.3.3 | Uninstalling the CPU heatsink and fan | 2-11 |
| 2.4 | System memory | 2-13 |
| 2.4.1 | Overview | 2-13 |
| 2.4.2 | Memory configurations | 2-13 |
| 2.4.3 | Installing a DIMM | 2-16 |
| 2.4.4 | Removing a DIMM | 2-16 |
| 2.5 | Expansion slots | 2-17 |
| 2.5.1 | Installing an expansion card | 2-17 |
| 2.5.2 | Configuring an expansion card | 2-17 |
| 2.5.3 | Interrupt assignments | 2-18 |
| 2.5.4 | PCI slots | 2-19 |
| 2.5.5 | PCI Express x1 slot | 2-19 |
| 2.5.6 | Two PCI Express x16 slots | 2-20 |
| 2.6 | Jumpers | 2-21 |
| 2.7 | Connectors | 2-23 |
| 2.7.1 | Rear panel connectors | 2-23 |
| 2.7.2 | Internal connectors | 2-25 |

Contents

Chapter 3: Powering up

| | | |
|-------|--------------------------------------------|-----|
| 3.1 | Starting up for the first time | 3-1 |
| 3.2 | Powering off the computer | 3-2 |
| 3.2.1 | Using the OS shut down function | 3-2 |
| 3.2.2 | Using the dual function power switch | 3-2 |
| 3.3 | ASUS POST Reporter™ | 3-3 |
| 3.3.1 | Vocal POST messages | 3-3 |
| 3.3.2 | Winbond Voice Editor | 3-5 |

Chapter 4: BIOS setup

| | | |
|-------|------------------------------------------------|------|
| 4.1 | Managing and updating your BIOS | 4-1 |
| 4.1.1 | Creating a bootable floppy disk | 4-1 |
| 4.1.2 | Updating the BIOS | 4-2 |
| 4.1.3 | Saving the current BIOS file | 4-4 |
| 4.1.4 | ASUS CrashFree BIOS 2 utility | 4-5 |
| 4.1.5 | ASUS EZ Flash utility | 4-7 |
| 4.1.6 | ASUS Update utility | 4-8 |
| 4.2 | BIOS setup program | 4-11 |
| 4.2.1 | BIOS menu screen | 4-12 |
| 4.2.2 | Menu bar | 4-12 |
| 4.2.3 | Legend bar | 4-13 |
| 4.2.4 | Menu items | 4-13 |
| 4.2.5 | Sub-menu items | 4-13 |
| 4.2.6 | Configuration fields | 4-13 |
| 4.2.7 | Pop-up window | 4-14 |
| 4.2.8 | General help | 4-14 |
| 4.3 | Main menu | 4-15 |
| 4.3.1 | System Time | 4-15 |
| 4.3.2 | System Date | 4-15 |
| 4.3.3 | Language | 4-15 |
| 4.3.4 | Legacy Diskette A | 4-15 |
| 4.3.5 | Primary and Secondary IDE Master/Slave | 4-16 |
| 4.3.6 | First, Second, Third, Fourth SATA Master | 4-18 |
| 4.3.7 | HDD SMART Monitoring | 4-19 |
| 4.3.8 | Installed Memory | 4-19 |
| 4.4 | Advanced menu | 4-20 |
| 4.4.1 | CPU Configuration | 4-20 |
| 4.4.2 | Chipset | 4-22 |
| 4.4.3 | PCIPnP | 4-22 |
| 4.4.4 | Onboard Devices Configuration | 4-23 |

Contents

| | | |
|--------|-----------------------------------|------|
| 4.4.5 | USB Configuration | 4-27 |
| 4.4.6 | SLI Configuration | 4-28 |
| 4.4.7 | JumperFree Configuration | 4-29 |
| 4.4.8 | LAN Cable Status | 4-37 |
| 4.4.9 | PEG Link Mode | 4-38 |
| 4.4.10 | Speech Configuration | 4-39 |
| 4.5 | Power menu | 4-40 |
| 4.5.1 | ACPI Suspend Type | 4-40 |
| 4.5.2 | ACPI APIC Support | 4-40 |
| 4.5.3 | APM Configuration | 4-41 |
| 4.5.4 | Hardware Monitor | 4-43 |
| 4.6 | Boot menu | 4-44 |
| 4.6.1 | Boot Device Priority | 4-44 |
| 4.6.3 | Hard Disk Drives | 4-45 |
| 4.6.2 | Removable Drives | 4-45 |
| 4.6.4 | CDROM Drives | 4-46 |
| 4.6.5 | Boot Settings Configuration | 4-46 |
| 4.6.6 | Security | 4-48 |
| 4.7 | Exit menu | 4-50 |

Chapter 5: Software support

| | | |
|-------|-----------------------------------------|------|
| 5.1 | Installing an operating system | 5-1 |
| 5.2 | Support CD information | 5-1 |
| 5.2.1 | Running the support CD | 5-1 |
| 5.2.2 | Drivers menu | 5-2 |
| 5.2.3 | Utilities menu | 5-3 |
| 5.2.4 | Manuals menu | 5-5 |
| 5.2.5 | ASUS Contact information | 5-6 |
| 5.2.6 | Other information | 5-6 |
| 5.3 | Software information | 5-9 |
| 5.3.1 | ASUS MyLogo2™ | 5-9 |
| 5.3.2 | AI NET 2 | 5-11 |
| | Using the Virtual Cable Tester™ | 5-11 |
| 5.3.3 | Audio configurations | 5-12 |
| 5.3.4 | Using the NVIDIA® Firewall™ | 5-18 |
| 5.4 | RAID configurations | 5-21 |
| 5.4.1 | Installing hard disks | 5-22 |
| 5.4.2 | NVIDIA® RAID configurations | 5-23 |
| 5.4.3 | Silicon Image RAID configurations | 5-30 |
| 5.5 | Creating a RAID driver disk | 5-37 |

Chapter 6: NVIDIA® SLI™ technology support

| | | |
|-------|-------------------------------------------------|-----|
| 6.1 | Overview | 6-1 |
| | Requirements | 6-1 |
| 6.2 | Dual graphics card setup | 6-2 |
| 6.2.1 | Setting the ASUS EZ selector card | 6-2 |
| 6.2.2 | Installing SLI-ready graphics cards | 6-4 |
| 6.2.3 | Setting the SLI mode in BIOS | 6-8 |
| 6.2.4 | Installing the device drivers | 6-8 |
| 6.2.5 | Enabling the multi-GPU feature in Windows | 6-8 |

Appendix: CPU features

| | | |
|-------|---------------------------------------------------|-----|
| A.1 | Intel® EM64T | A-1 |
| | Using the Intel® EM64T feature | A-1 |
| A.2 | Enhanced Intel SpeedStep® Technology (EIST) | A-1 |
| A.2.1 | System requirements | A-1 |
| A.2.2 | Using the EIST | A-2 |
| A.3 | Intel® Hyper-Threading Technology | A-3 |
| | Using the Hyper-Threading Technology | A-3 |

Notices

Federal Communications Commission Statement

This device complies with Part 15 of the FCC Rules. Operation is subject to the following two conditions:

- This device may not cause harmful interference, and
- This device must accept any interference received including interference that may cause undesired operation.

This equipment has been tested and found to comply with the limits for a Class B digital device, pursuant to Part 15 of the FCC Rules. These limits are designed to provide reasonable protection against harmful interference in a residential installation. This equipment generates, uses and can radiate radio frequency energy and, if not installed and used in accordance with manufacturer's instructions, may cause harmful interference to radio communications. However, there is no guarantee that interference will not occur in a particular installation. If this equipment does cause harmful interference to radio or television reception, which can be determined by turning the equipment off and on, the user is encouraged to try to correct the interference by one or more of the following measures:

- Reorient or relocate the receiving antenna.
- Increase the separation between the equipment and receiver.
- Connect the equipment to an outlet on a circuit different from that to which the receiver is connected.
- Consult the dealer or an experienced radio/TV technician for help.



The use of shielded cables for connection of the monitor to the graphics card is required to assure compliance with FCC regulations. Changes or modifications to this unit not expressly approved by the party responsible for compliance could void the user's authority to operate this equipment.

Canadian Department of Communications Statement

This digital apparatus does not exceed the Class B limits for radio noise emissions from digital apparatus set out in the Radio Interference Regulations of the Canadian Department of Communications.

This class B digital apparatus complies with Canadian ICES-003.

Safety information

Electrical safety

- To prevent electrical shock hazard, disconnect the power cable from the electrical outlet before relocating the system.
- When adding or removing devices to or from the system, ensure that the power cables for the devices are unplugged before the signal cables are connected. If possible, disconnect all power cables from the existing system before you add a device.
- Before connecting or removing signal cables from the motherboard, ensure that all power cables are unplugged.
- Seek professional assistance before using an adapter or extension cord. These devices could interrupt the grounding circuit.
- Make sure that your power supply is set to the correct voltage in your area. If you are not sure about the voltage of the electrical outlet you are using, contact your local power company.
- If the power supply is broken, do not try to fix it by yourself. Contact a qualified service technician or your retailer.

Operation safety

- Before installing the motherboard and adding devices on it, carefully read all the manuals that came with the package.
- Before using the product, make sure all cables are correctly connected and the power cables are not damaged. If you detect any damage, contact your dealer immediately.
- To avoid short circuits, keep paper clips, screws, and staples away from connectors, slots, sockets and circuitry.
- Avoid dust, humidity, and temperature extremes. Do not place the product in any area where it may become wet.
- Place the product on a stable surface.
- If you encounter technical problems with the product, contact a qualified service technician or your retailer.

About this guide

This user guide contains the information you need when installing and configuring the motherboard.

How this guide is organized

This guide contains the following parts:

- **Chapter 1: Product introduction**
This chapter describes the features of the motherboard and the new technology it supports.
- **Chapter 2: Hardware information**
This chapter lists the hardware setup procedures that you have to perform when installing system components. It includes description of the switches, jumpers, and connectors on the motherboard.
- **Chapter 3: Powering up**
This chapter describes the power up sequence, the vocal POST messages, and ways of shutting down the system.
- **Chapter 4: BIOS setup**
This chapter tells how to change system settings through the BIOS Setup menus. Detailed descriptions of the BIOS parameters are also provided.
- **Chapter 5: Software support**
This chapter describes the contents of the support CD that comes with the motherboard package.
- **Chapter 6: NVIDIA® SLI™ technology support**
This chapter tells how to install SLI-ready PCI Express graphics cards.
- **Appendix: CPU features**
The Appendix describes the CPU features that the motherboard supports.

Where to find more information

Refer to the following sources for additional information and for product and software updates.

1. ASUS websites

The ASUS website provides updated information on ASUS hardware and software products. Refer to the ASUS contact information.

2. Optional documentation

Your product package may include optional documentation, such as warranty flyers, that may have been added by your dealer. These documents are not part of the standard package.

Conventions used in this guide

To make sure that you perform certain tasks properly, take note of the following symbols used throughout this manual.



DANGER/WARNING: Information to prevent injury to yourself when trying to complete a task.



CAUTION: Information to prevent damage to the components when trying to complete a task.



IMPORTANT: Instructions that you **MUST** follow to complete a task.



NOTE: Tips and additional information to help you complete a task.

Typography

Bold text

Indicates a menu or an item to select.

Italics

Used to emphasize a word or a phrase.

<Key>

Keys enclosed in the less-than and greater-than sign means that you must press the enclosed key.

Example: <Enter> means that you must press the Enter or Return key.

<Key1+Key2+Key3>

If you must press two or more keys simultaneously, the key names are linked with a plus sign (+).

Example: <Ctrl+Alt+D>

Command

Means that you must type the command exactly as shown, then supply the required item or value enclosed in brackets.

Example: At the DOS prompt, type the command line:

```
afudos /i[filename]
afudos /iP5ND2E.ROM
```

P5ND2-SLI Deluxe specifications summary

| | |
|---------------------------------------|----------------------------------------------------------------------------------------------------------------------------------------------------------------------------------------------------------------------------------------------------------------------------------------------------------------------------------------------------------------------------------------------------------------------------------------------------------------------------------------------------------------------------------------------------------------------------------------------------------------------------------------------------------------------------------------------------------------------------|
| CPU | <p>LGA775 socket for Intel® Pentium® Processor Extreme Edition/Intel® Pentium® D/Intel® Pentium® 4/Intel® Celeron® processors</p> <p>Compatible with Intel® PCG 05B/05A and 04B/04A processors</p> <p>Supports Intel® Enhanced Memory 64 Technology (EM64T)</p> <p>Supports Enhanced Intel SpeedStep® Technology (EIST)</p> <p>Supports Intel® Hyper-Threading Technology</p> <p>(Note: Due to chipset limitation, the Intel® Pentium® D 820 processor works only in single-core mode.)</p> |
| Chipset | <p>Northbridge: NVIDIA® nForce™ 4 SLI - Intel® Edition</p> <p>Southbridge: NVIDIA® MCP-04</p> |
| Front Side Bus | <p>1066/800/533 MHz</p> |
| Memory | <p>Dual-channel memory architecture</p> <p>4 x 240-pin DIMM sockets support unbuffered non-ECC DDR2-667/DDR2-533 memory modules</p> <p>Supports up to 8 GB system memory</p> <p>Supports the NVIDIA® Dynamic Adaptive Speculative Preprocessor (DASP) and QuickSync feature</p> |
| Expansion slots | <p>2 x PCI Express x16 slots with Scalable Link Interface (SLI™) support</p> <p>2 x PCI Express x1 slots</p> <p>3 x PCI slots</p> |
| Scalable Link Interface (SLI™) | <p>SLI™ mode supports:</p> <ul style="list-style-type: none"> - 2 x identical SLI™-ready PCI Express x16 graphics cards <p>(Note: In SLI mode, the PCI Express x16 slots work at the bandwidth of PCI Express x8. The combined bandwidth of these maintain the bandwidth of PCI Express x16.)</p> <p>Single card mode supports (default):</p> <ul style="list-style-type: none"> - 1 x any PCI Express x16 graphics card on the first slot (blue) - 1 x PCI Express x1 card on the second slot (black) <p>ASUS EZ Selector</p> <p>ASUS SLI Warning LED</p> <p>ASUS EZ Plug™</p> <p>ASUS PEG Link for dual PCI Express graphics cards</p> <p>ASUS Two-slot thermal design</p> |
| AI Audio | <p>Realtek® ALC850 8-channel CODEC</p> <p>1 x Coaxial S/PDIF out port</p> <p>1 x Optical S/PDIF out port</p> <p>Supports Universal Audio Jack (UAJ®) Technology</p> <p>Supports Audio Sensing and Enumeration Technology</p> |

(continued on the next page)

P5ND2-SLI Deluxe specifications summary

| | |
|------------------------------|----------------------------------------------------------------------------------------------------------------------------------------------------------------------------------------------------------------------------------------------------------------------------------------------------------------------------------------------------------------------------------------------------------------------------------------------------------------------------------------------------------------------------------------------------------------------------------------------------------------------------------------------------------------|
| Storage | <p>NVIDIA® nForce™ MCP-04 chipset supports:</p> <ul style="list-style-type: none"> - 2 x Ultra DMA 133/100/66/33 - 4 x Serial ATA 3Gb/s devices - RAID 0, RAID 1, RAID 0+1, RAID 5 and JBOD that spans across the Serial ATA and Parallel ATA drives - up to 8 hard disk drives of Multi-RAID configuration <p>Silicon Image 3132 SATA controller supports:</p> <ul style="list-style-type: none"> - 1 x Internal Serial ATA 3Gb/s hard disk drive - 1 x External Serial ATA 3Gb/s (SATA On-The-Go) - RAID 0 and RAID 1 |
| Dual Gigabit LAN | <p>NVIDIA® nForce™ 4 - Intel® Edition built-in Gigabit MAC with external Marvell® PHY supports:</p> <ul style="list-style-type: none"> - NV ActiveArmor - NV Firewall - AI NET2 <p>Intel® 82540EM Gigabit LAN controller</p> |
| USB | <p>Supports up to 10 USB 2.0 ports</p> |
| IEEE 1394 | <p>TI 1394a controller supports:</p> <ul style="list-style-type: none"> - 1 x Internal IEEE 1394a connector - 1 x IEEE 1394a connector at the rear panel |
| Overclocking features | <p>CPU Lock Free ASUS AI Overclocking (Intelligent Frequency Tuner) ASUS NOS (Non-delay Overclocking System) ASUS PEG Link for single/dual graphics cards Precision Tweaker supports:</p> <ul style="list-style-type: none"> - DIMM voltage: 8-step DRAM voltage control - Core voltage: Adjustable CPU voltage at 0.0125 V - PCI Express Frequency: Allows 1MHz increment from 100MHz to 150MHz - Stepless Frequency Selection(SFS) allows 1MHz increment from 133MHz to 400 MHz <p>ASUS C.P.R. (CPU Parameter Recall) Adjustable FSB/DDR2 frequencies with fixed PCI/PCIe frequencies</p> |
| Special features | <p>ASUS SATA On-The-Go ASUS SLI Warning LED ASUS EZ Plug ASUS Post Reporter™ ASUS Q-Fan2 ASUS CrashFree BIOS 2 ASUS Multi-language BIOS ASUS MyLogo2 ASUS EZ Flash</p> |

(continued on the next page)

P5ND2-SLI Deluxe specifications summary

| | |
|----------------------------|--------------------------------------------------------------------------------------------------------------------------------------------------------------------------------------------------------------------------------------------------------------------------------------------------------------------------------------------------------------------------------------------------------------------------------------------------------------------------------------------------------------------------------------------------------------------------------------|
| BIOS features | 4 MB Flash ROM, Phoenix-Award BIOS, PnP, DMI2.0, SM BIOS 2.3, WfM2.0 |
| Power Requirement | ATX power supply (with 24-pin and 4-pin 12 V plugs) ATX 12 V 2.0 compliant ASUS EZ Plug* (*When using two graphics cards and a 20-pin ATX PSU) |
| Rear panel | 1 x Parallel port 2 x LAN (RJ-45) ports 4 x USB 2.0 ports 1 x External SATA port (SATA On-The-Go) 1 x Optical S/PDIF Out port 1 x Coaxial S/PDIF Out port 1 x PS/2 keyboard port (purple) 1 x PS/2 mouse port (green) 1 x IEEE1394a connector 8-channel audio ports |
| Internal connectors | 1 x Floppy disk drive connector 2 x IDE connectors 5 x Serial ATA connectors 1 x Serial port connector (COM port) 1 x 24-pin ATX power connector 1 x 4-pin ATX 12 V power connector 1 x 4-pin ASUS EZ Plug™ connector 3 x USB connectors for 6 additional USB 2.0 ports 1 x Internal audio connectors (CD/AUX) 1 x IEEE 1394a connector 1 x GAME/MIDI connector 1 x Chassis intrusion connector 1 x Front panel audio connector 1 x SLI selector card connector CPU, Chassis (x2), Chipset, Power fan connectors System panel connector |
| Support CD contents | Device drivers ASUS PC Probe II ASUS Update ASUS AI Booster Microsoft® DirectX 9.0c Anti-Virus Utility (OEM version) WinDVD Suite (OEM version) Winbond Voice Editor Adobe Acrobat Reader ASUS Screensaver |
| Form Factor | ATX form factor: 12 in x 9.6 in (30.5 cm x 24.4 cm) |

*Specifications are subject to change without notice.

This chapter describes the motherboard features and the new technologies it supports.

Product introduction



Chapter summary



| | | |
|-----|------------------------|-----|
| 1.1 | Welcome! | 1-1 |
| 1.2 | Package contents | 1-1 |
| 1.3 | Special features | 1-2 |

1.1 Welcome!

Thank you for buying an ASUS® P5ND2-SLI Deluxe motherboard!

The motherboard delivers a host of new features and latest technologies, making it another standout in the long line of ASUS quality motherboards!

Before you start installing the motherboard, and hardware devices on it, check the items in your package with the list below.

1.2 Package contents

Check your motherboard package for the following items.

| | |
|------------------------|-------------------------------------------------------------------------------------------------------------------------------------------------------------------------------------------------------|
| Motherboard | ASUS P5ND2-SLI Deluxe motherboard |
| I/O modules | IEEE1394a module Serial (COM) port module USB 2.0 (2 ports) and GAME (1 port) module |
| Cables | 5 x Serial ATA cables 2 x Serial ATA power cables (dual plugs) 1 x Serial ATA power cable (single plug) 1 x Ultra DMA 133/100/66 cables 40-conductor IDE cable Floppy disk drive cable |
| Accessories | I/O shield 1 x SLI connector 1 x SLI retention module |
| Application CDs | ASUS motherboard support CD InterVideo® WinDVD Suite® (OEM version) |
| Documentation | User guide |



If any of the above items is damaged or missing, contact your retailer.

1.3 Special features

1.3.1 Product highlights

Latest processor technology

The motherboard comes with a 775-pin surface mount Land Grid Array (LGA) socket designed for the Intel® Pentium® Processor Extreme Edition, Intel® Pentium® D, Intel® Pentium® 4, and Intel® Celeron® processor in the 775-land package. The motherboard supports Intel® processors with 1066/800/533 MHz Front Side Bus (FSB). The motherboard also supports the Intel® Hyper-Threading Technology, Intel® Dual-Core Technology and is fully compatible with Intel® 05B/05A and 04B/04A processors. See page 2-6 for details.

NVIDIA® Scalable Link Interface (SLI™) - Intel® Edition

The NVIDIA® nForce4® Scalable Link Interface (SLI™) - Intel® Edition technology allows two graphics processing units (GPUs) in a single system. This technology takes advantage of the PCI Express™ bus architecture and features intelligent hardware and software solutions that allows multiple GPUs to work together and achieve exceptional graphics performance. See Chapter 6 for details.

Intel® Dual-Core Technology CPU support

The motherboard supports dual-core processors containing two physical CPU cores with dedicated L2 caches to meet demands for more powerful processing. See page 2-6 for details.

Intel® EM64T

The motherboard supports Intel® processors with the Intel® EM64T (Extended Memory 64 Technology). The Intel® EM64T feature allows your computer to run on 64-bit operating systems and access larger amounts of system memory for faster and more efficient computing. See the Appendix for details.

Enhanced Intel SpeedStep® Technology (EIST)

The Enhanced Intel SpeedStep® Technology (EIST) intelligently manages the CPU resources by automatically adjusting the CPU voltage and core frequency depending on the CPU loading and system speed or power requirement. See Appendix for details.

DDR2 memory support

The motherboard supports DDR2 memory which features data transfer rates of 667 MHz or 533 MHz to meet the higher bandwidth requirements of the latest 3D graphics, multimedia, and Internet applications. The dual-channel DDR2 architecture doubles the bandwidth of your system memory to boost system performance, eliminating bottlenecks with peak bandwidths of up to 8.5 GB/s. See pages 2-13 to 2-16 for details.

QuickSync

The NVIDIA® nForce4® SLI™ - Intel® Edition memory controller features the QuickSync synchronization technology that transfers memory requests and data between the Front Side Bus (FSB) and memory clock domains in the shortest amount of time. QuickSync ensures that the memory controller has the shortest latency between receiving/placing CPU requests, and between receiving the data from memory and sending it to the CPU for all FSB and memory speeds.

DASP 3.0

The NVIDIA® Dynamic Adaptive Speculative Preprocessor (DASP) 3.0 comes with sophisticated data pre-fetch algorithms in preprocessors that are tasked to track data threads and pre-fetch appropriate data for improved performance.

Built-in NVFirewall™ and NVActiveArmor™



The NVIDIA® Firewall™ (NVFirewall™) is an easy-to-use high-performance desktop firewall application that protects your system from intruders. Integrated into the NVIDIA® nForce4® SLI™ chipset, it provides advanced anti-computer-hacking technologies, remote management capabilities, and a user-friendly setup wizard that improves overall system security.

Enhancing your network security is the NVIDIA® ActiveArmor™ (NV ActiveArmor™) engine that provides advanced data packet inspection. This innovative technology ensures that only safe data packets are passed on the network. It boosts overall system performance by offloading the CPU from the rigorous task of filtering data packets. See page 5-18 for details.

Serial ATA 3Gb/s and SATA-On-The-Go



The motherboard supports the Serial ATA 3 Gb/s technology through the Serial ATA interfaces and the NVIDIA® SLI™ - Intel® Edition chipset. The Serial ATA 3 Gb/s specification provides twice the bandwidth of the current Serial ATA products with a host of new features, including Native Command Queuing (NCQ), Power Management (PM) Implementation Algorithm, and Hot Swap. Serial ATA allows thinner, more flexible cables with lower pin count and reduced voltage requirements.

Leveraging these Serial ATA 3Gb/s features is the SATA-On-The-Go. This external port on the rear panel I/O provides smart setup, hot-plug and support for up to 16 devices with port-multiplier functions. See pages 2-27 and 2-28 for details.

Dual RAID solution

Onboard RAID controllers provide the motherboard with dual-RAID functionality that allows you to select the best RAID solution using IDE or Serial ATA devices.

The NVIDIA® nForce4® SLI™ allows RAID 0, RAID 1, RAID 0+1, JBOD, and a software patch to support RAID 5 configuration for four SATA 3Gb/s and two PATA connectors. See pages 2-27 and 5-23.

The Sil3132R controller supports two additional SATA 3Gb/s connectors and allows RAID 0 and RAID 1 configurations. See pages 2-28 and 5-30 for details.

Dual Gigabit LAN solution

The motherboard comes with dual Gigabit LAN controllers to provide the total solution for your networking needs. These network controllers use the PCI Express segment to provide faster data bandwidth for your wired or wireless Internet, LAN, and file sharing requirements. See pages 2-23 and 2-24 for details.

PCI Express™ interface

The motherboard fully supports PCI Express, the latest I/O interconnect technology that speeds up the PCI bus. PCI Express features point-to-point serial interconnections between devices and allows higher clockspeeds by carrying data in packets. This high speed interface is software compatible with existing PCI specifications. See pages 2-19 and 2-20 for details.

CPU Lock Free

This feature allows you to adjust the CPU multiplier to 14x. Setting the appropriate BIOS setting automatically reduces the CPU multiplier value for more flexibility when increasing external FSB. See page 4-20 for details

S/PDIF digital sound ready

The motherboard supports the S/PDIF technology through the S/PDIF interfaces on the rear panel and at midboard. The S/PDIF technology turns your computer into a high-end entertainment system with digital connectivity to powerful audio and speaker systems. See page 2-25 for details.

IEEE 1394a support

The IEEE 1394a interface provides high-speed and flexible PC connectivity to a wide range of peripherals and devices compliant to the IEEE 1394a standard. The IEEE 1394a interface allows up to 400 Mbps transfer rates through simple, low-cost, high-bandwidth asynchronous (real-time) data interfacing between computers, peripherals, and consumer electronic devices such as camcorders, VCRs, printers, TVs, and digital cameras. See pages 2-24 and 2-30 for details.

USB 2.0 technology

The motherboard implements the Universal Serial Bus (USB) 2.0 specification, dramatically increasing the connection speed from the 12 Mbps bandwidth on USB 1.1 to a fast 480 Mbps on USB 2.0. USB 2.0 is backward compatible with USB 1.1. See pages 2-24 and 2-30 for details.

1.3.2 ASUS AI features

AI Quiet

The ASUS AI Quiet function dynamically controls CPU speed and reduces temperature and fan speeds, thus minimizing noise and ensuring quiet operation.

AI NOS™ (Non-Delay Overclocking System)

ASUS Non-delay Overclocking System™ (NOS) is a technology that auto-detects the CPU loading and dynamically overclocks the CPU speed only when needed. See page 4-29 for details.

Precision Tweaker

This feature allows you to fine tune the CPU/memory voltage and gradually increase the memory Front Side Bus (FSB) and PCI Express frequency at 1MHz increment to achieve maximum system performance.

AI NET 2

AI NET 2 is a BIOS-based diagnostic tool that detects and reports Ethernet cable faults and shorts. With this utility, you can easily monitor the condition of the Ethernet cable(s) connected to the LAN (RJ-45) port(s). During the bootup process, AI NET 2 immediately diagnoses the LAN cable(s) and reports shorts and faults up to 100 meters at 1 meter accuracy. See pages 4-37 and 5-11 for details.

AI Audio technology

The motherboard supports 8-channel audio through the onboard Realtek® ALC850 CODEC with 16-bit DAC, a stereo 16-bit ADC, and an AC97 2.3 compatible multi-channel audio designed for PC multimedia systems. It also provides Jack-Sensing function, S/PDIF out support, interrupt capability and includes the Realtek® proprietary UAJ® (Universal Audio Jack) technology. See pages 2-23 and 5-12 for details.

Fanless Design

The ASUS fanless design allows multi-directional heat flow from major thermal sources in the motherboard to lower overall system temperature, resulting in quieter operation and longer system life.

PEG Link Mode

This feature enhances your PCI Express graphics card performance. It allows the motherboard to automatically adjust the PCI Express graphics link mode to the correct frequency based on the system configuration. Four additional settings are available for overclocking the PEG Link Mode.

CPU Lock Free

This feature allows you to adjust the CPU multiplier to 14x. Setting the appropriate BIOS setting automatically reduces the CPU multiplier value for more flexibility when increasing external FSB. See page 4-20 for details

1.3.3 Innovative ASUS features

CPU Lock Free

This feature allows you to adjust the CPU multiplier to 14x. Setting the appropriate BIOS setting automatically reduces the CPU multiplier value for more flexibility when increasing external FSB. See page 4-20 for details

ASUS Two-slot thermal design

The motherboard is designed with two PCI Express x1 slots placed between the PCI Express x16 slots allowing an increase in airflow between the two PCI Express x16 graphics cards. This special design permits more room for ventilation thus lowering the overall system temperature.

CrashFree BIOS 2

This feature allows you to restore the original BIOS data from the support CD in case when the BIOS codes and data are corrupted. This protection eliminates the need to buy a replacement ROM chip. See page 4-5 for details.

ASUS Q-Fan 2 technology

The ASUS Q-Fan 2 technology smartly adjusts the fan speeds according to the system loading to ensure quiet, cool, and efficient operation. See page 4-43 for details.

ASUS Multi-language BIOS

The multi-language BIOS allows you to select the language of your choice from the available options. The localized BIOS menus allow easier and faster configuration. See page 4-15 for details.

ASUS POST Reporter™

The motherboard offers a new exciting feature called the ASUS POST Reporter™. The ASUS POST Reporter™ provides friendly voice messages and alerts during the Power-On Self-Tests (POST) to inform you of the system boot status and causes of boot errors, if any. The bundled Winbond Voice Editor software lets you to customize the voice messages in different languages. See page 3-3 for details.

ASUS MyLogo2™

This new feature present in the motherboard allows you to personalize and add style to your system with customizable boot logos. See page 5-11 for details.

ASUS EZ Plug™

This patented ASUS technology is a 4-pin auxiliary +12V connector that is designed to maintain the voltage integrity of your system. This plug guarantees adequate supply of power to the motherboard and other installed peripherals. See page 2-34 for the illustration.

C.P.R. (CPU Parameter Recall)

The C.P.R. feature of the motherboard BIOS allows automatic re-setting to the BIOS default settings in case the system hangs due to overclocking. When the system hangs due to overclocking, C.P.R. eliminates the need to open the system chassis and clear the RTC data. Simply shut down and reboot the system, and the BIOS automatically restores the CPU default setting for each parameter.

This chapter lists the hardware setup procedures that you have to perform when installing system components. It includes description of the jumpers and connectors on the motherboard.

Hardware information



Chapter summary



| | | |
|-----|-------------------------------------|------|
| 2.1 | Before you proceed | 2-1 |
| 2.2 | Motherboard overview | 2-2 |
| 2.3 | Central Processing Unit (CPU) | 2-6 |
| 2.4 | System memory | 2-13 |
| 2.5 | Expansion slots | 2-17 |
| 2.6 | Jumpers | 2-21 |
| 2.7 | Connectors | 2-23 |

2.1 Before you proceed

Take note of the following precautions before you install motherboard components or change any motherboard settings.



- Unplug the power cord from the wall socket before touching any component.
- Use a grounded wrist strap or touch a safely grounded object or to a metal object, such as the power supply case, before handling components to avoid damaging them due to static electricity.
- Hold components by the edges to avoid touching the ICs on them.
- Whenever you uninstall any component, place it on a grounded antistatic pad or in the bag that came with the component.
- **Before you install or remove any component, ensure that the ATX power supply is switched off or the power cord is detached from the power supply.** Failure to do so may cause severe damage to the motherboard, peripherals, and/or components.

Onboard LED

The motherboard comes with a standby power LED. The green LED lights up to indicate that the system is ON, in sleep mode, or in soft-off mode. This is a reminder that you should shut down the system and unplug the power cable before removing or plugging in any motherboard component. The illustration below shows the location of the onboard LED.

The red warning LED lights up when you installed two graphics card but did not connect the ASUS EZ Plug™. The illustration below shows the location of the onboard LEDs.

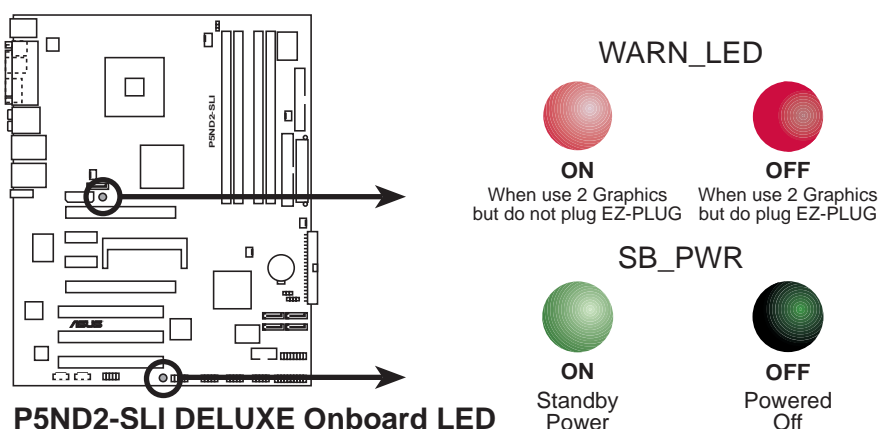

Make sure to connect the EZPlug when using two PCI Express graphics cards and a 20-pin ATX power supply unit.

2.2 Motherboard overview

Before you install the motherboard, study the configuration of your chassis to ensure that the motherboard fits into it.



Make sure to unplug the power cord before installing or removing the motherboard. Failure to do so can cause you physical injury and damage motherboard components.

2.2.1 Placement direction

When installing the motherboard, make sure that you place it into the chassis in the correct orientation. The edge with external ports goes to the rear part of the chassis as indicated in the image below.

2.2.2 Screw holes

Place nine (9) screws into the holes indicated by circles to secure the motherboard to the chassis.



Do not overtighten the screws! Doing so can damage the motherboard.

Place this side towards
the rear of the chassis

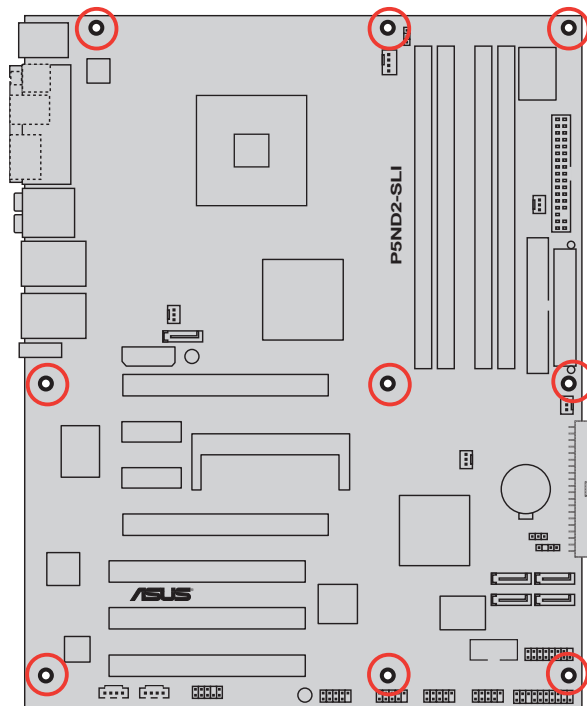

2.2.3 Motherboard layout

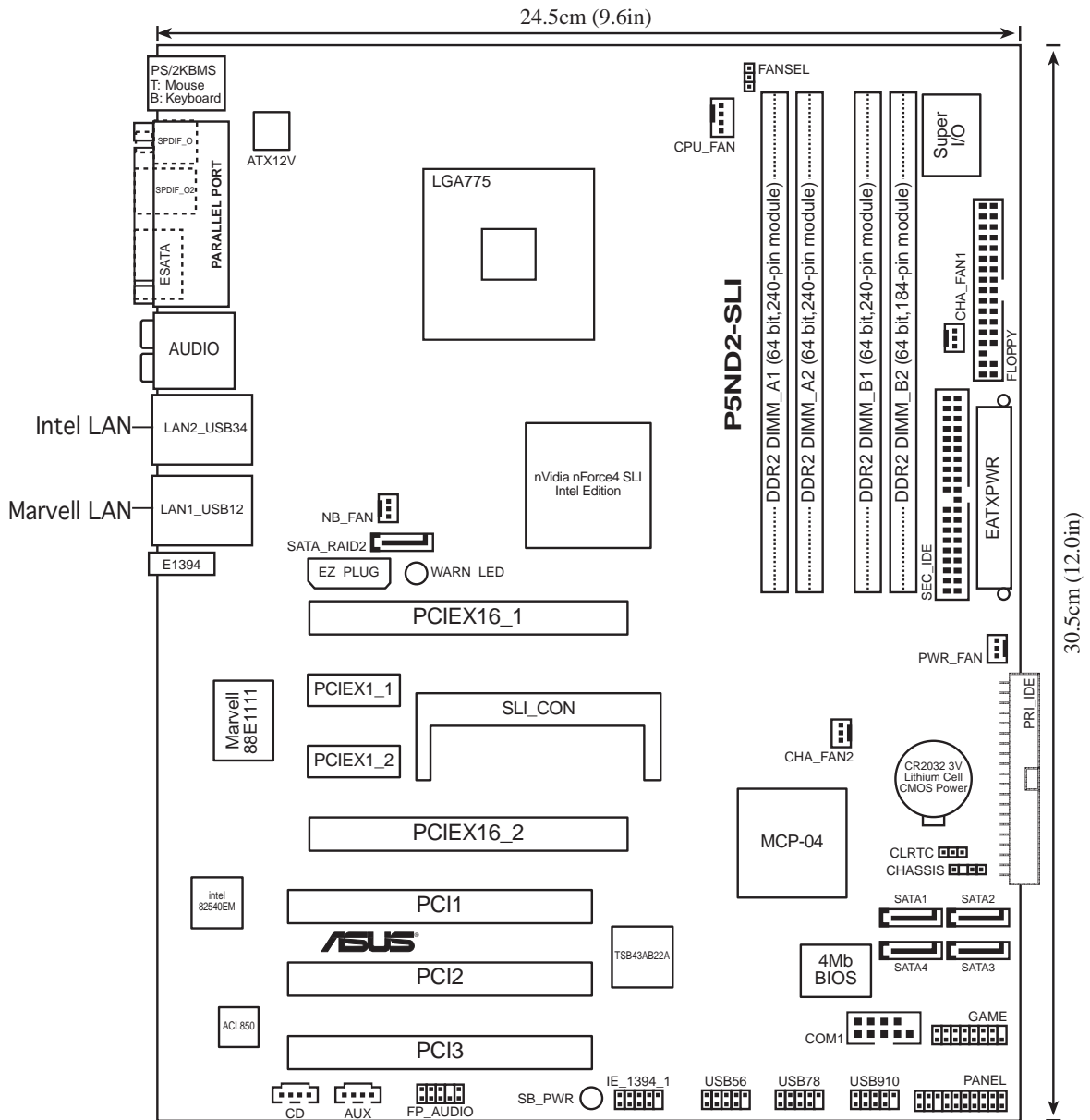

2.2.4 Layout contents

| Slots | | Page |
|--------------|----------------------|-------------|
| 1. | DDR2 DIMM slots | 2-13 |
| 2. | PCI slots | 2-19 |
| 3. | PCI Express x1 slot | 2-19 |
| 4. | PCI Express x16 slot | 2-20 |

| Jumpers | | Page |
|----------------|------------------------------|-------------|
| 1. | Clear RTC RAM (3-pin CLRRTC) | 2-21 |
| 2. | Fan selector (3-pin FANSEL) | 2-22 |

| Rear panel connectors | | Page |
|------------------------------|---------------------------------------|-------------|
| 1. | PS/2 mouse port (green) | 2-23 |
| 2. | Parallel port | 2-23 |
| 3. | Rear Speaker Out port (gray) | 2-23 |
| 4. | Side Speaker Out port (black) | 2-23 |
| 5. | Center/Subwoofer port (yellow orange) | 2-23 |
| 6. | Line In port (light blue) | 2-23 |
| 7. | Line Out port (lime) | 2-23 |
| 8. | Microphone port (pink) | 2-23 |
| 9. | LAN 2 (RJ-45) [Intel®] | 2-24 |
| 10. | LAN 1 (RJ-45) [Marvell®] | 2-24 |
| 11. | IEEE 1394 port | 2-24 |
| 12. | USB 2.0 ports 3 and 4 | 2-24 |
| 13. | USB 2.0 ports 1 and 2 | 2-24 |
| 14. | External SATA port | 2-25 |
| 14. | Optical S/PDIF Out port | 2-25 |
| 15. | Coaxial S/PDIF Out port | 2-25 |
| 16. | PS/2 keyboard port (purple) | 2-25 |

| Internal connectors | | Page |
|---------------------|----------------------------------------------------------------------------------------------------------------------------------------|------|
| 1. | Floppy disk drive connector (34-1 pin FLOPPY) | 2-25 |
| 2. | Primary IDE connector (40-1 pin PRI_IDE) | 2-26 |
| 3. | Secondary IDE connector (40-1 pin SEC_IDE) | 2-26 |
| 4. | SouthBridge SATA connectors (7-pin SATA1 [blue], SATA2 [blue], SATA3 [blue], SATA4 [blue]) | 2-27 |
| 5. | Silicon Image SATA RAID connectors (7-pin SATA_RAID2[red]) | 2-28 |
| 6. | Optical drive audio connector (4-pin CD) | 2-29 |
| 7. | Auxiliary audio connector (4-pin AUX) | 2-29 |
| 8. | Front panel audio connector (10-1 pin FP_AUDIO) | 2-29 |
| 9. | USB connectors (10-1 pin USB56, USB78, USB910) | 2-30 |
| 10. | IEEE 1394 port connectors (10-1 pin IE1394_1) | 2-30 |
| 11. | GAME/MIDI port connector (16-1 pin GAME) | 2-31 |
| 12. | Serial port connector (10-1 pin COM1) | 2-31 |
| 13. | CPU, Chassis, NorthBridge, and Power Fan connectors (4-pin CPU_FAN, 3-pin PWR_FAN, 3-pin NB_FAN, 3-pin CHA_FAN1, 3-pin CHA_FAN2) | 2-32 |
| 14. | Chassis intrusion connector (4-1 pin CHASSIS) | 2-33 |
| 15. | ATX power connectors (24-pin EATXPWR, 4-pin ATX12V, 4-pin EZ_PLUG) | 2-34 |
| 16. | ASUS EZ Selector card connector (144-pin SLI_CON) | 2-35 |
| 17. | System panel connector (20-pin PANEL) | 2-35 |
| | System power LED (Green 3-pin PLED) | |
| | Hard disk drive activity LED (Red 2-pin IDE_LED) | |
| | System warning speaker (Orange 4-pin SPEAKER) | |
| | ATX power button/soft-off button (Yellow 2-pin PWR) | |
| | Reset button (Blue 2-pin RESET) | |

2.3 Central Processing Unit (CPU)

The motherboard comes with a surface mount LGA775 socket designed for the Intel® Pentium® D, Intel® Pentium® 4 and Intel® Celeron® processors in the 775-land package.

This motherboard supports the Intel® Pentium® Processor Extreme Edition, the latest CPU with embedded dual physical cores and Hyper-Threading technology, making four CPU threads possible. Refer to the table below for the operating system support status.

| OS licensing support list | |
|---------------------------------------------|------------------------------------------------------------|
| Intel Dual-Core CPU support | Intel Dual-Core CPU and Hyper-Threading Technology support |
| Windows® 2000 Professional | |
| Windows® 2000 Advanced Server | Windows® 2000 Advanced Server |
| Windows® XP Home | Windows® XP Home |
| Windows® XP Professional | Windows® XP Professional |
| Windows® Server 2003 - Standard, Enterprise | Windows® Server 2003 - Standard, Enterprise |



- Due to chipset limitation, Intel® Pentium® D 820 processors work only in single-core CPU mode.
- Due to chipset limitation, dual-core processors cannot support the Intel® EIST, TM2, and C1E functions.



- Install a chassis fan with at least a speed of 2000 rpm and 9 CFM turnrate when using a dual-core CPU to ensure system stability. Overheating can permanently damage the system and/or CPU.
- We do not recommend overclocking the system beyond the product specifications. The motherboard warranty will not be extended to any damage caused by overclocking.
- Upon purchase of the motherboard, make sure that the PnP cap is on the socket and the socket contacts are not bent. Contact your retailer immediately if the PnP cap is missing, or if you see any damage to the PnP cap/socket contacts/motherboard components. ASUS will shoulder the cost of repair only if the damage is shipment/transit-related.
- Keep the cap after installing the motherboard. ASUS will process Return Merchandise Authorization (RMA) requests only if the motherboard comes with the cap on the LGA775 socket.
- The product warranty does not cover damage to the socket contacts resulting from incorrect CPU installation/removal, or misplacement/loss/incorrect removal of the PnP cap.



Visit the Intel® website (www.intel.com) for the latest information

2.3.1 Installing the CPU

To install a CPU:

1. Locate the CPU socket on the motherboard.

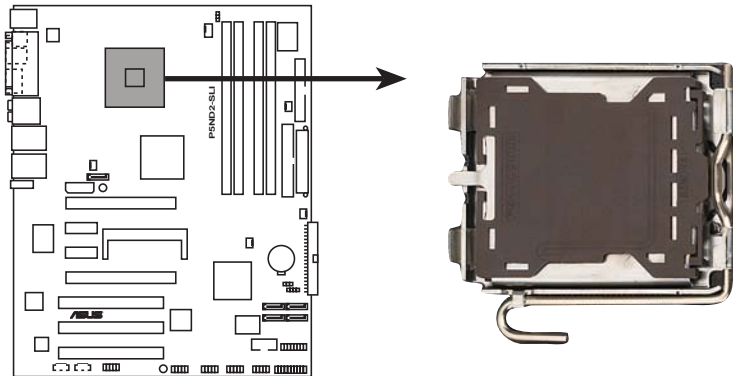

P5ND2-SLI DELUXE CPU Socket 775



Before installing the CPU, make sure that the cam box is facing towards you and the load lever is on your left.

2. Press the load lever with your thumb (A), then move it to the left (B) until it is released from the retention tab.

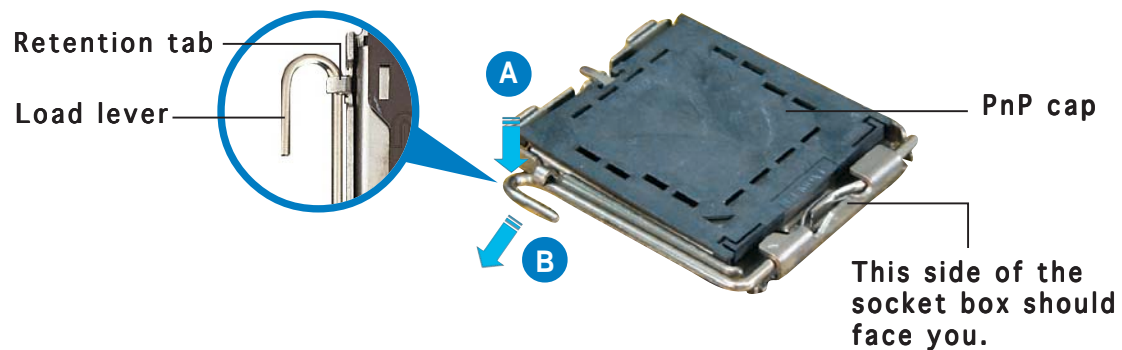

To prevent damage to the socket pins, do not remove the PnP cap unless you are installing a CPU.

3. Lift the load lever in the direction of the arrow to a 135° angle.

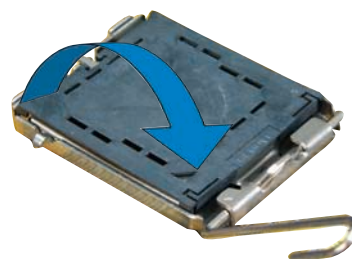

- Lift the load plate with your thumb and forefinger to a 100° angle (A), then push the PnP cap from the load plate window to remove (B).

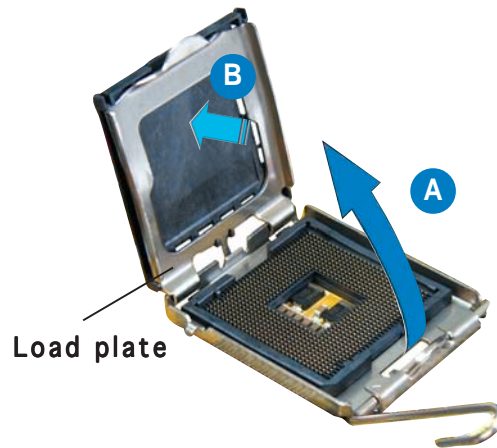

- Position the CPU over the socket, making sure that the gold triangle is on the bottom-left corner of the socket. The socket alignment key should fit into the CPU notch.

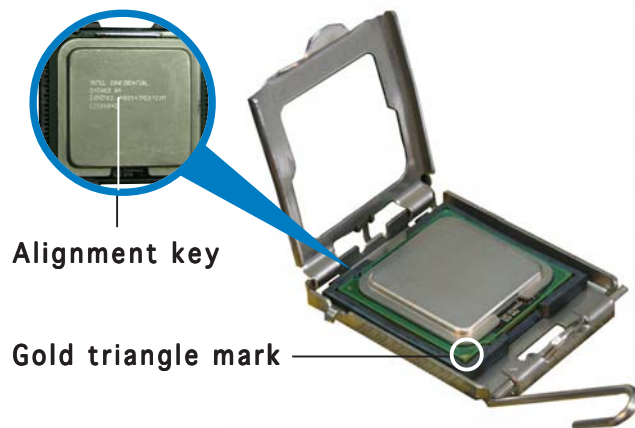

The CPU fits in only one correct orientation. DO NOT force the CPU into the socket to prevent bending the connectors on the socket and damaging the CPU!

- Close the load plate (A), then push the load lever (B) until it snaps into the retention tab.



The motherboard supports Intel® Pentium® 4 LGA775 processors with the Intel® Enhanced Memory 64 Technology (EM64T), Enhanced Intel SpeedStep® Technology (EIST), and Hyper-Threading Technology. Refer to the Appendix for more information on these CPU features.

2.3.2 Installing the CPU heatsink and fan

Intel® LGA775 processors require a specially designed heatsink and fan assembly to ensure optimum thermal condition and performance.



- When you buy a boxed Intel® processor, the package includes the CPU fan and heatsink assembly. If you buy a CPU separately, make sure that you use only Intel®-certified multi-directional heatsink and fan.
- Your Intel® LGA775 processor heatsink and fan assembly comes in a push-pin design and requires no tool to install.
- If you purchased a separate CPU heatsink and fan assembly, make sure that you have properly applied Thermal Interface Material to the CPU heatsink or CPU before you install the heatsink and fan assembly.



Make sure that you have installed the motherboard to the chassis before you install the CPU fan and heatsink assembly.

To install the CPU heatsink and fan:

1. Place the heatsink on top of the installed CPU, making sure that the four fasteners match the holes on the motherboard.



Orient the heatsink and fan assembly such that the CPU fan cable is closest to the CPU fan connector.

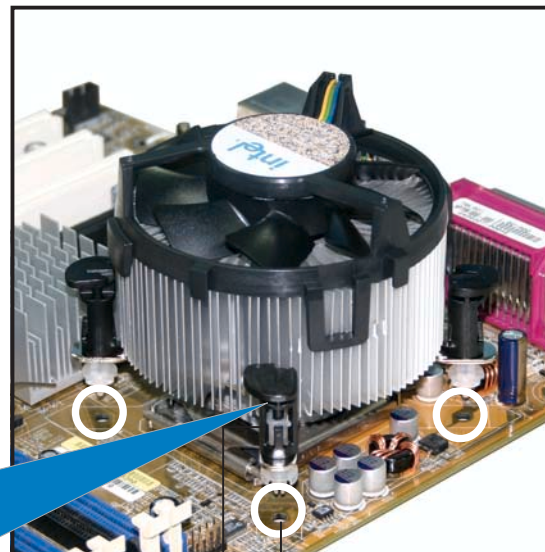

Narrow end
of the groove

Fastener

Motherboard hole



Make sure to orient each fastener with the narrow end of the groove pointing outward. (The photo shows the groove shaded for emphasis.)

2. Push down two fasteners at a time in a diagonal sequence to secure the heatsink and fan assembly in place.

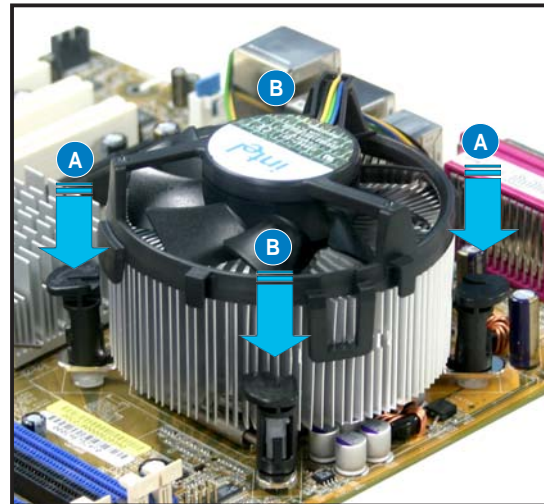
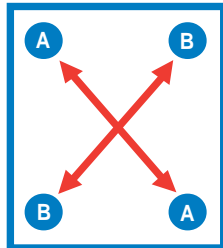

3. Connect the CPU fan cable to the connector on the motherboard labeled CPU_FAN.

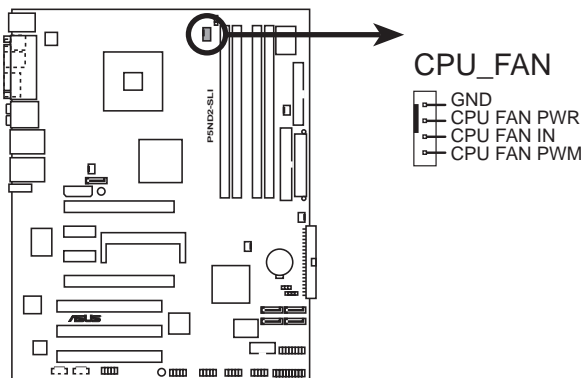

P5ND2-SLI DELUXE CPU fan connector



- Do not forget to connect the CPU fan connector! Hardware monitoring errors can occur if you fail to plug this connector.
- The retention module of some third-party CPU heatsink and fan can interfere with chipset components at the bottom of the board. Before purchasing a separate CPU heatsink and fan, make sure that it will not interfere with the chipset components.

2.3.3 Uninstalling the CPU heatsink and fan

To uninstall the CPU heatsink and fan:

1. Disconnect the CPU fan cable from the connector on the motherboard.
2. Rotate each fastener counterclockwise.



3. Pull up two fasteners at a time in a diagonal sequence to disengage the heatsink and fan assembly from the motherboard.

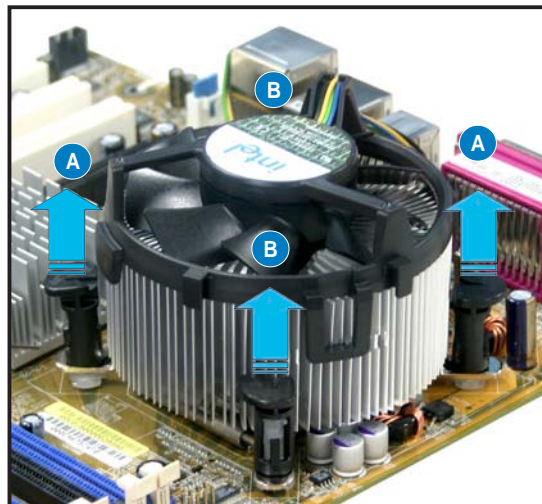
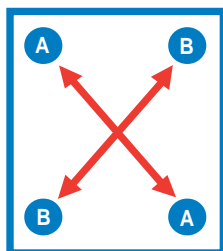

4. Carefully remove the heatsink and fan assembly from the motherboard.

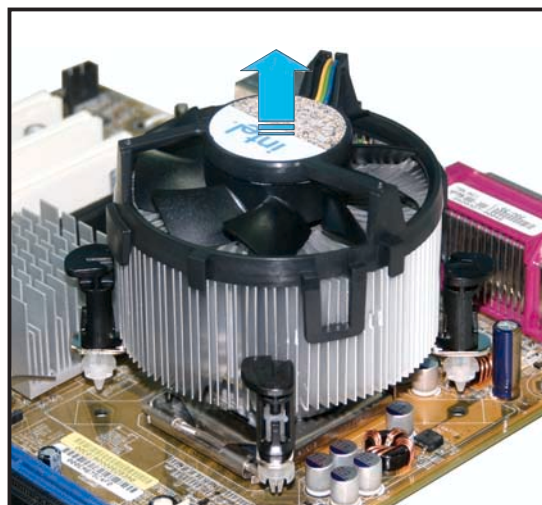

5. Rotate each fastener clockwise to ensure correct orientation when reinstalling.

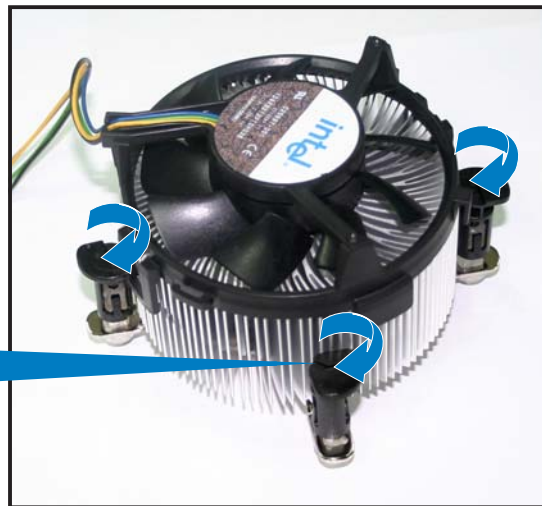
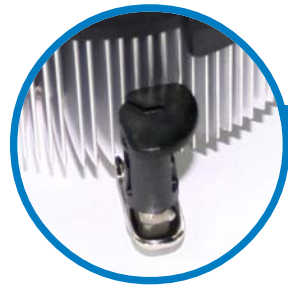

Narrow end of the groove



The narrow end of the groove should point outward after resetting. (The photo shows the groove shaded for emphasis.)

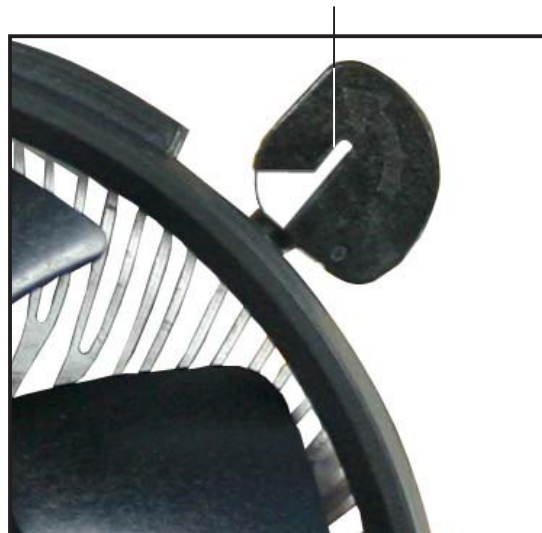

Refer to the documentation in the boxed or stand-alone CPU fan package for detailed information on CPU fan installation.

2.4 System memory

2.4.1 Overview

The motherboard comes with four Double Data Rate 2 (DDR2) Dual Inline Memory Modules (DIMM) sockets.

A DDR2 module has the same physical dimensions as a DDR DIMM but has a 240-pin footprint compared to the 184-pin DDR DIMM. DDR2 DIMMs are notched differently to prevent installation on a DDR DIMM socket.

The figure illustrates the location of the DDR2 DIMM sockets:

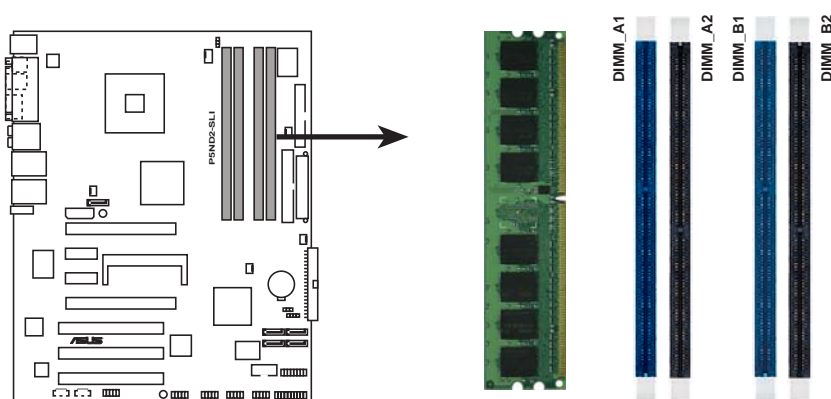

P5ND2-SLI DELUXE 240-pin DDR DIMM sockets

| Channel | Sockets |
|-----------|---------------------|
| Channel A | DIMM_A1 and DIMM_A2 |
| Channel B | DIMM_B1 and DIMM_B2 |

2.4.2 Memory configurations

You may install 256 MB, 512 MB, 1 GB and 2 GB unbuffered non-ECC DDR2 DIMMs into the DIMM sockets.



- For dual-channel configuration, the total size of memory module(s) installed per channel must be the same (DIMM_A1 + DIMM_A2 = DIMM_B1 + DIMM_B2).
- Always install DIMMs with the same CAS latency. For optimum compatibility, it is recommended that you obtain memory modules from the same vendor. Refer to the DDR2 Qualified Vendors List on the next page for details.
- Due to chipset resource allocation, the system may detect less than 8 GB system memory when you installed four 2 GB DDR2 memory modules.
- This motherboard does not support memory modules made up of 128 Mb chips or double sided x16 memory modules.

Qualified Vendors Lists (QVL)

DDR2-800/667 with 800 MHz capability*

| DDR2 | | | | | | | DIMM support | | |
|------|------|--------|-------|-------|---------|-----------|--------------|---|---|
| Type | Size | Vendor | Model | Brand | Side(s) | Component | A | B | C |
| | | | | | | | | | |
| | | | | | | | | | |
| | | | | | | | | | |
| | | | | | | | | | |
| | | | | | | | | | |

* ASUS has tested and overclocked these memory modules to 720 MHz. ASUS, however, does not guarantee that these memory modules will run at the same speed on your system.

DDR2-667 MHz capability

| Size | Vendor | Model | Brand | Side(s) | Component | DIMM support | | |
|--------|----------|----------------------|----------|---------|------------------|--------------|---|---|
| | | | | | | A | B | C |
| 256MB | SAMSUNG | M378T3253FZ0-CE6 | SAMSUNG | SS | K4T56083QF-ZCE6 | • | • | • |
| 512MB | SAMSUNG | M378T6453FZ0-CE6 | SAMSUNG | DS | K4T56083QF-ZCE6 | • | • | • |
| 256MB | SAMSUNG | M391T3253FZ0-CE6 | SAMSUNG | SS | K4T56083QF-ZCE6 | • | • | • |
| 512MB | SAMSUNG | M391T6453FZ0-CE6 | SAMSUNG | DS | K4T56083QF-ZCE6 | • | • | • |
| 256MB | Kingston | HYB18T512800AF3S | Kingston | SS | KVR667D2N5/512 | • | • | • |
| 1024MB | Kingston | E5108AE-GE-E | Kingston | DS | KVR667D2N5/1G | • | • | |
| 512MB | Hynix | HYMP564U64AP8-Y5 | Hynix | SS | HY5PS12821AFP-Y5 | • | • | • |
| 1024MB | Hynix | HYMP512U64AP8-Y5 | Hynix | DS | HY5PS12821AFP-Y5 | • | • | |
| 1024MB | Hynix | HYMP512U64AP8-Y4 | Hynix | DS | HY5PS12821AFP-Y4 | • | • | |
| 512MB | Hynix | HYMP564U64AP8-Y4 | Hynix | SS | HY5PS12821AFP-Y4 | • | • | • |
| 512MB | MICRON | MT16HTF6464AY-667B4 | MICRON | DS | 4VB41D9CZM | • | • | • |
| 1024MB | MICRON | MT16HTF12864AY-667A2 | MICRON | DS | 4UAID9CWX | • | • | |
| 256MB | MICRON | MT8HTF3264AY-667B5 | MICRON | SS | 4SB42D9CZM | • | • | |
| 512MB | MICRON | MT16HTF6464AY-667B3 | MICRON | DS | 4TB41D9CZM | • | • | |
| 512MB | Infineon | HYS64T64000HU-3S-A | Infineon | SS | HYB18T512800AF3S | • | • | |
| 256MB | ELPIDA | EBE25UC8ABFA-6E-E | ELPIDA | SS | E2508AB-GE-E | • | • | • |
| 512MB | ELPIDA | EBE51UD8AEFA-6E-E | ELPIDA | SS | E5108AE-GE-E | • | • | • |
| 1024MB | ELPIDA | EBE11UD8AEFA-6E-E | N/A | DS | N/A | • | • | |
| 512MB | GEIL | GX21GB5300DC | N/A | SS | GL2L64G088BA30T | • | • | |
| 256MB | NANYA | NT256T64UH4A0FY-3C | NANYA | SS | NT5TU32M16AG-3C | • | • | • |
| 512MB | TwinMOS | 8G-25JK5-EBT | N/A | SS | E5108AE-GE-E | • | • | • |

Side(s): **SS** - Single-sided **DS** - Double-sided

DIMM support:

- A** - Supports one module inserted into either slot, in Single-channel memory configuration.
- B** - Supports one pair of modules inserted into either the yellow slots or the black slots as one pair of Dual-channel memory configuration.
- C** - Supports two pairs of modules inserted into the yellow and black slots as two pairs of Dual-channel memory configuration.



Visit the ASUS website for the latest DDR2-800/DDR2-667 MHz QVL.

DDR2-533

| Size | Vendor | Model | Brand | Side(s) | Component | DIMM support | | |
|--------|----------|----------------------|----------|---------|--------------------|--------------|---|---|
| | | | | | | A | B | C |
| 512MB | SAMSUNG | M378T6553BG0-CD5 | N/A | SS | K4T51083QB-GCD5 | • | | • |
| 1024MB | SAMSUNG | M378T2953BG0-CD5 | N/A | DS | K4T51083QB-GCD5 | • | • | |
| 256MB | SAMSUNG | M378T3253FG0-CD5 | N/A | SS | K4T56083QF-GCD5 | • | | • |
| 512MB | SAMSUNG | M378T6453FG0-CD5 | N/A | DS | K4T56083QF-GCD5 | • | | • |
| 512MB | Infineon | HYS64T64000GU-3.7-A | Infineon | SS | HYB18T512800AC37 | • | • | • |
| 256MB | Infineon | HYS64T32000HU-3.7-A | Infineon | SS | HYB18T512160AF-3.7 | • | • | • |
| 1024MB | Infineon | HYS64T128020HU-3.7-A | Infineon | DS | HYB18T512800AF37 | • | • | |
| 512MB | Infineon | HYS64T64000HU-3.7-A | Infineon | SS | HYB18T512800AF37 | • | | • |
| 512MB | CORSAIR | CM2X512-4200 | N/A | DS | N/A | • | • | • |
| 512MB | MICRON | MT16HTF6464AG-53EB2 | MICRON | DS | 4FBII9BQM | • | • | • |
| 1024MB | MICRON | MT16HTF12864AY-53EA1 | MICRON | DS | 4JAIID9CRZ | | • | |
| 256MB | MICRON | MT8HTF3264AY-53EB3 | MICRON | SS | 4FBII9CHM | • | • | • |
| 512MB | MICRON | MT16HTF6464AY-53EB2 | MICRON | DS | 4FBII9CHM | • | | • |
| 256MB | MICRON | N/A | MICRON | SS | 4DBIIZ9BQT | • | • | • |
| 1024MB | MICRON | MT16HTF12864AY-53EA1 | MICRON | DS | 4MAIID9CRZ | • | • | |
| 1024MB | Kingston | KVR533D2N4/1G | N/A | DS | E5108AB-5C-E | • | • | |
| 256MB | Kingston | KVR533D2N4/256 | N/A | SS | HYB18T512160AC-3.7 | • | | • |
| 512MB | Kingston | KVR533D2N4/512 | ELPIDA | SS | E5108AB-5C-E | • | • | • |
| 512MB | Hynix | HYMP564U648-C4 | N/A | SS | HY5PS12821F-C4 | • | • | • |
| 1024MB | Hynix | HYMP512U648-C4 | N/A | DS | HY5PS12821F-C4 | • | • | |
| 1024MB | Hynix | HYMP512U648-C4 | N/A | DS | HY5PS12821FP-C4 | • | • | |
| 512MB | ELPIDA | EBE51UD8ABFA-5C | ELPIDA | DS | E5108AB-5C-E | | | • |
| 512MB | ELPIDA | EBE51UD8ABFA-5C-E | ELPIDA | DS | E5108AB-5C-E | | • | • |
| 1024MB | ELPIDA | EBE11UD8ABFA-5C-E | ELPIDA | DS | E5108AB-5C-E | • | • | • |

Side(s): **SS** - Single-sided **DS** - Double-sided

DIMM support:

- A** - Supports one module inserted into either slot, in Single-channel memory configuration.
- B** - Supports one pair of modules inserted into either the yellow slots or the black slots as one pair of Dual-channel memory configuration.
- C** - Supports two pairs of modules inserted into the yellow and black slots as two pairs of Dual-channel memory configuration.



Visit the [ASUS website](#) for the latest DDR2-533 MHz QVL.

2.4.3 Installing a DIMM



Unplug the power supply before adding or removing DIMMs or other system components. Failure to do so can cause severe damage to both the motherboard and the components.

To install a DIMM:

1. Unlock a DIMM socket by pressing the retaining clips outward.
2. Align a DIMM on the socket such that the notch on the DIMM matches the break on the socket.
3. Firmly insert the DIMM into the socket until the retaining clips snap back in place and the DIMM is properly seated.

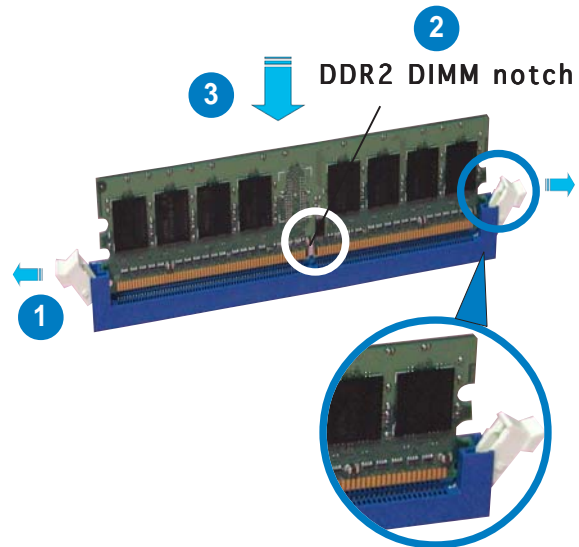

Unlocked retaining clip



- A DDR2 DIMM is keyed with a notch so that it fits in only one direction. Do not force a DIMM into a socket to avoid damaging the DIMM.
- The DDR2 DIMM sockets do not support DDR DIMMs. DO not install DDR DIMMs to the DDR2 DIMM sockets.

2.4.4 Removing a DIMM

Follow these steps to remove a DIMM.

1. Simultaneously press the retaining clips outward to unlock the DIMM.



Support the DIMM lightly with your fingers when pressing the retaining clips. The DIMM might get damaged when it flips out with extra force.

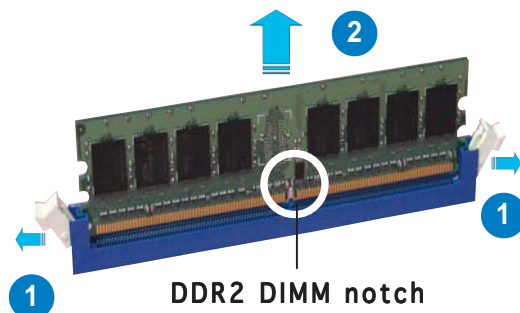

2. Remove the DIMM from the socket.

2.5 Expansion slots

In the future, you may need to install expansion cards. The following sub-sections describe the slots and the expansion cards that they support.



Make sure to unplug the power cord before adding or removing expansion cards. Failure to do so may cause you physical injury and damage motherboard components.

2.5.1 Installing an expansion card

To install an expansion card:

1. Before installing the expansion card, read the documentation that came with it and make the necessary hardware settings for the card.
2. Remove the system unit cover (if your motherboard is already installed in a chassis).
3. Remove the bracket opposite the slot that you intend to use. Keep the screw for later use.
4. Align the card connector with the slot and press firmly until the card is completely seated on the slot.
5. Secure the card to the chassis with the screw you removed earlier.
6. Replace the system cover.

2.5.2 Configuring an expansion card

After installing the expansion card, configure the it by adjusting the software settings.

1. Turn on the system and change the necessary BIOS settings, if any. See Chapter 4 for information on BIOS setup.
2. Assign an IRQ to the card. Refer to the tables on the next page.
3. Install the software drivers for the expansion card.



When using PCI cards on shared slots, ensure that the drivers support “Share IRQ” or that the cards do not need IRQ assignments. Otherwise, conflicts will arise between the two PCI groups, making the system unstable and the card inoperable. Refer to the table on the next page for details.

2.5.3 Interrupt assignments

Standard interrupt assignments

| IRQ | Priority | Standard Function |
|-----|----------|------------------------------|
| 0 | 1 | System Timer |
| 1 | 2 | Keyboard Controller |
| 2 | — | Re-direct to IRQ#9 |
| 4 | 12 | Communications Port (COM1)* |
| 5 | 13 | IRQ holder for PCI steering* |
| 6 | 14 | Floppy Disk Controller |
| 7 | 15 | Printer Port (LPT1)* |
| 8 | 3 | System CMOS/Real Time Clock |
| 9 | 4 | IRQ holder for PCI steering* |
| 10 | 5 | IRQ holder for PCI steering* |
| 11 | 6 | IRQ holder for PCI steering* |
| 12 | 7 | PS/2 Compatible Mouse Port* |
| 13 | 8 | Numeric Data Processor |
| 14 | 9 | Primary IDE Channel |
| 15 | 10 | Secondary IDE Channel |

* These IRQs are usually available for ISA or PCI devices.

IRQ assignments for this motherboard

| | A | B | C | D | E | F | G | H |
|----------------------------|--------|--------|--------|--------|--------|---|---|---|
| PCI Express x16 slot | shared | — | — | — | — | — | — | — |
| PCI Express x16 slot | shared | — | — | — | — | — | — | — |
| PCI Express x1 slot | shared | — | — | — | — | — | — | — |
| PCI Express x1 slot | shared | — | — | — | — | — | — | — |
| PCI slot 1 | shared | — | — | — | — | — | — | — |
| PCI slot 2 | — | shared | — | — | — | — | — | — |
| PCI slot 3 | — | — | shared | — | — | — | — | — |
| Onboard USB 1.0 controller | shared | — | — | — | — | — | — | — |
| Onboard USB 1.0 controller | — | shared | — | — | — | — | — | — |
| Onboard USB 2.0 controller | — | — | shared | — | — | — | — | — |
| Onboard LAN1 | shared | — | — | — | — | — | — | — |
| Onboard LAN2 | — | — | — | shared | — | — | — | — |
| Onboard IDE controller | — | — | — | — | shared | — | — | — |
| Onboard SATA controller | shared | — | — | — | — | — | — | — |
| Onboard PCI SATA RAID (SI) | — | — | — | shared | — | — | — | — |
| Onboard 1394a | — | — | — | — | shared | — | — | — |
| Onboard Audio controller | shared | — | — | — | — | — | — | — |

2.5.4 PCI slots

The PCI slots support cards such as a LAN card, SCSI card, USB card, and other cards that comply with PCI specifications. The figure shows a LAN card installed on a PCI slot.

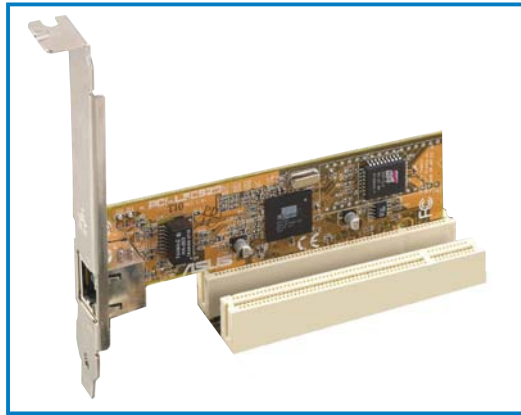

2.5.5 PCI Express x1 slot

This motherboard supports PCI Express x1 network cards, SCSI cards and other cards that comply with the PCI Express specifications. The figure shows a network card installed on the PCI Express x1 slot.

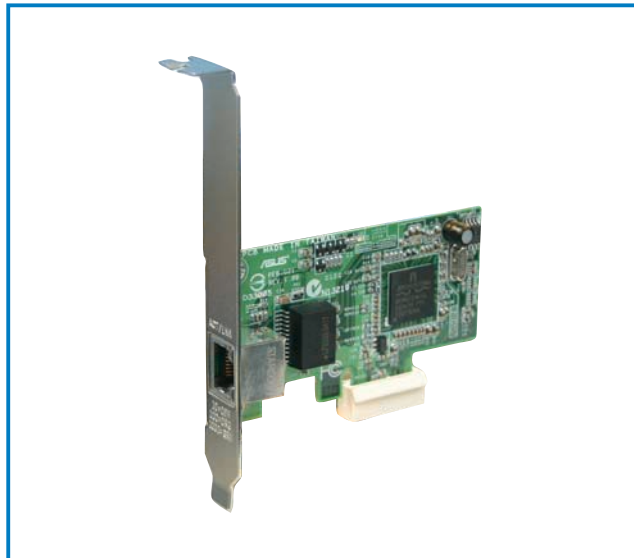

2.5.6 Two PCI Express x16 slots

This motherboard supports one PCI Express x16 graphics card or two SLI-ready PCI Express x16 graphic cards that comply with the PCI Express specifications. The figure shows a graphics card installed on the PCI Express x16 slot.

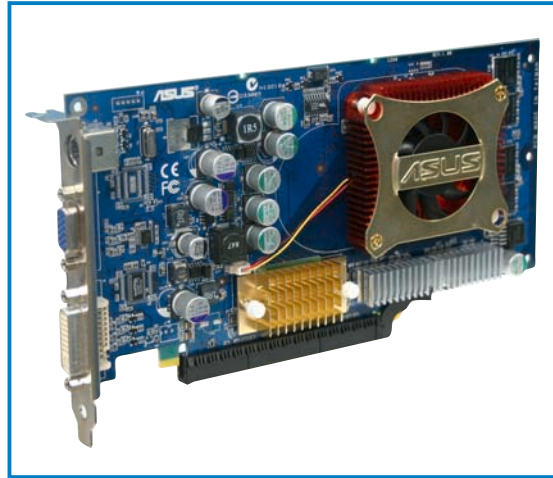

- Install a chassis fan when using two graphics cards for better thermal environment.
- Connect the EZ Plug™ when using two graphics cards for stable performance.



- In Normal mode, only the PCI Express blue slot can be used for PCI Express x16 graphics cards. The PCI Express black slot functions as a PCI Express x1 slot.
- In SLI mode, the PCI Express x16 slots work at the bandwidth of PCI Express x8. The combined bandwidth of these maintain the bandwidth of PCI Express x16.
- See the table below for possible PCI Express card configurations.

Table 1 PCI Express x16 slot configurations

| EZ selector card setting | | PCIEX16_1 (blue) | | PCIEX16_2 (black) | |
|--------------------------|-----------------------------------------|----------------------------|-------|------------------------------------------|----------------|
| | | Card Type | Speed | Card Type | Speed |
| Single Video Card | | any PCIe x16 graphics card | x16 | any PCIe x1 card | x1 |
| Dual Video Card | SLI mode | SLI-ready graphics card | x8 | SLI-ready graphics card | x8 |
| | Multi-monitor, RAID or LAN setup | any PCIe x16 graphics card | x8 | any PCIe graphics card, RAID or LAN card | x8, x4, x2, x1 |

2.6 Jumpers

1. Clear RTC RAM (CLRTC)

This jumper allows you to clear the Real Time Clock (RTC) RAM in CMOS. You can clear the CMOS memory of date, time, and system setup parameters by erasing the CMOS RTC RAM data. The onboard button cell battery powers the RAM data in CMOS, which include system setup information such as system passwords.

To erase the RTC RAM:

1. Turn OFF the computer and unplug the power cord.
2. Remove the onboard battery.
3. Move the jumper cap from pins 1-2 (default) to pins 2-3. Keep the cap on pins 2-3 for about 5~10 seconds, then move the cap back to pins 1-2.
4. Re-install the battery.
5. Plug the power cord and turn ON the computer.
6. Hold down the key during the boot process and enter BIOS setup to re-enter data.



Except when clearing the RTC RAM, never remove the cap on CLRTC jumper default position. Removing the cap will cause system boot failure!

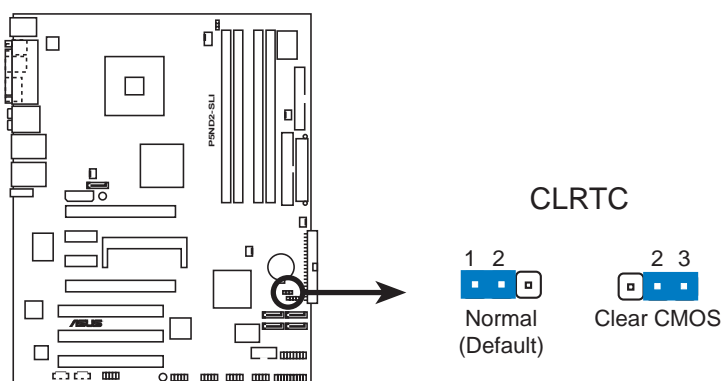

P5ND2-SLI DELUXE Clear RTC RAM



You do not need to clear the RTC when the system hangs due to overclocking. For system failure due to overclocking, use the C.P.R. (CPU Parameter Recall) feature. Shut down and reboot the system so the BIOS can automatically reset parameter settings to default values.

2. Fan power (3-pin FANSEL)

This jumper allows you to connect either a 3-pin or a 4-pin fan cable plug to the CPU fan connector (CPU_FAN). Set this jumper to pins 1-2 if you are using a 4-pin fan cable plug, or to pins 2-3 if you are using a 3-pin plug.

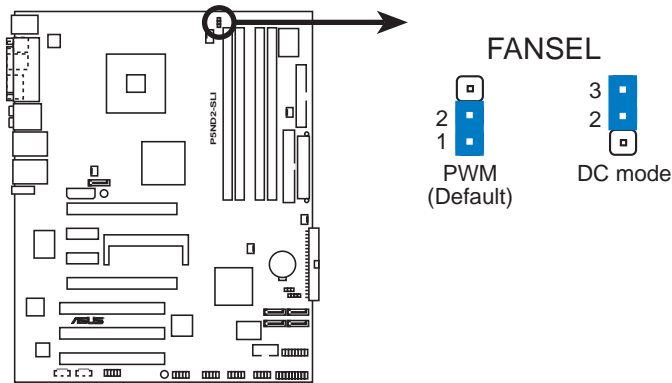

P5ND2-SLI DELUXE FAN power setting



Set this jumper to DC mode (pins [2-3]) when using a CPU heatsink and fan with a 4-pin power cable that do not comply with Intel®'s PWM fan specifications.

2.7 Connectors

2.7.1 Rear panel connectors

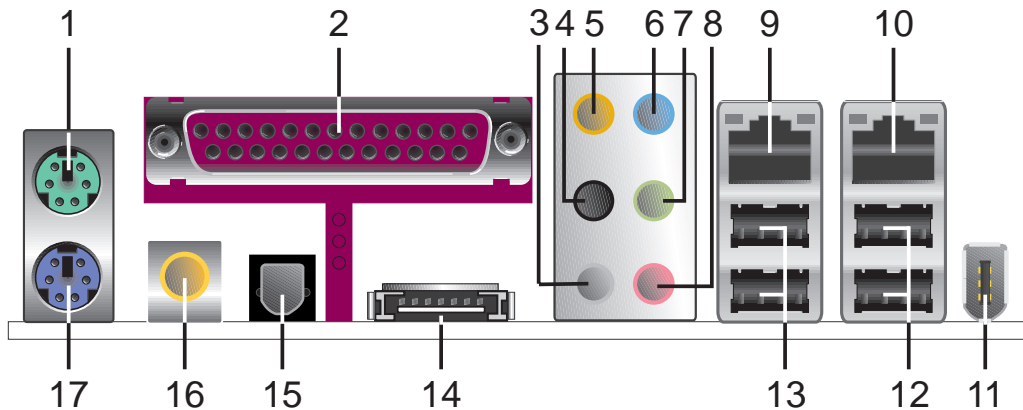

1. **PS/2 mouse port (green).** This port is for a PS/2 mouse.
2. **Parallel port.** This 25-pin port connects a parallel printer, a scanner, or other devices.
3. **Rear Speaker Out port (gray).** This port connects the rear speakers on a 4-channel, 6-channel, or 8-channel audio configuration.
4. **Side Speaker Out port (black).** This port connects the side speakers in an 8-channel audio configuration.
5. **Center/Subwoofer port (yellow orange).** This port connects the center/subwoofer speakers.
6. **Line In port (light blue).** This port connects the tape, CD, DVD player, or other audio sources.
7. **Line Out port (lime).** This port connects a headphone or a speaker. In 4-channel, 6-channel, and 8-channel configuration, the function of this port becomes Front Speaker Out.
8. **Microphone port (pink).** This port connects a microphone.



- Refer to the audio configuration table below for the function of the audio ports in 2, 4, 6, or 8-channel configuration.
- See section “5.3.3 Audio configurations” on page 5-12 for details.

Audio 2, 4, 6, or 8-channel configuration

| Port | Headset 2-channel | 4-channel | 6-channel | 8-channel |
|---------------|----------------------|-------------------|-------------------|-------------------|
| Light Blue | Line In | Line In | Line In | Line In |
| Lime | Line Out | Front Speaker Out | Front Speaker Out | Front Speaker Out |
| Pink | Mic In | Mic In | Mic In | Mic In |
| Gray | • | Rear Speaker Out | Rear Speaker Out | Rear Speaker Out |
| Black | • | • | • | Side Speaker Out |
| Yellow Orange | • | • | Center/Subwoofer | Center/Subwoofer |

9. **LAN 2 (RJ-45) port.** Supported by the Intel® 82540EM Gigabit LAN controller, this port allows Gigabit connection to a Local Area Network (LAN) through a network hub. Refer to the table below for the LAN port LED indications.
10. **LAN 1 (RJ-45) port.** Supported by the MCP-04 SouthBridge built-in Gigabit MAC with External Marvell® LAN PHY, this port allows Gigabit connection to a Local Area Network (LAN) through a network hub.

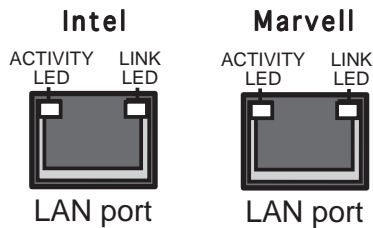

32-bit OS LAN port LED indications

| Intel | | Marvell | | Description |
|--------------|----------|--------------|----------|---------------------|
| Activity LED | Link LED | Activity LED | Link LED | |
| YELLOW | ORANGE | OFF | OFF | Soft-off Mode |
| YELLOW | ORANGE | YELLOW* | OFF | During Power ON/OFF |
| YELLOW* | ORANGE | YELLOW* | ORANGE | 100 Mbps connection |
| YELLOW* | GREEN | YELLOW* | GREEN | 1 Gbps connection |

* Blinking

64-bit OS LAN port LED indications

| Intel | | Marvell | | Description |
|--------------|----------|--------------|----------|---------------------|
| Activity LED | Link LED | Activity LED | Link LED | |
| YELLOW | ORANGE | DNR | DNR | Soft-off Mode |
| YELLOW | ORANGE | DNR | DNR | During Power ON/OFF |
| YELLOW* | ORANGE | DNR | DNR | 100 Mbps connection |
| YELLOW* | GREEN | DNR | DNR | 1 Gbps connection |

* Blinking

DNR - Driver Not Ready

11. **IEEE 1394a port.** This 6-pin IEEE 1394 port provides high-speed connectivity for audio/video devices, storage peripherals, PCs, or portable devices.
12. **USB 2.0 ports 1 and 2.** These two 4-pin Universal Serial Bus (USB) ports are available for connecting USB 2.0 devices.
13. **USB 2.0 ports 3 and 4.** These two 4-pin Universal Serial Bus (USB) ports are available for connecting USB 2.0 devices.

14. **External Serial ATA port.** This port connects to an external SATA box or a Serial ATA port multiplier that supports up to 16 devices and enables smart setup and hot-plug function.
15. **Optical S/PDIF Out port.** This port connects an external audio output device via an optical S/PDIF cable.
16. **Coaxial S/PDIF Out port.** This port connects an external audio output device via a coaxial S/PDIF cable.
17. **PS/2 keyboard port (purple).** This port is for a PS/2 keyboard.

2.7.2 Internal connectors

1. Floppy disk drive connector (34-1 pin FLOPPY)

This connector is for the provided floppy disk drive (FDD) signal cable. Insert one end of the cable to this connector, then connect the other end to the signal connector at the back of the floppy disk drive.



Pin 5 on the connector is removed to prevent incorrect cable connection when using a FDD cable with a covered Pin 5.

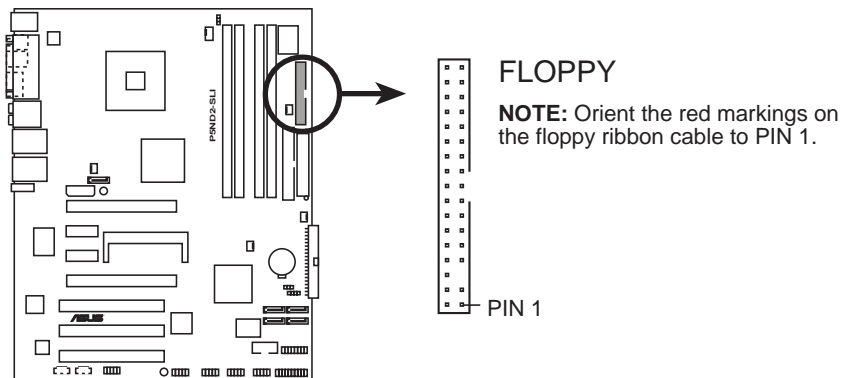

P5ND2-SLI DELUXE Floppy disk drive connector

2. IDE connectors (40-1 pin PRI_IDE, SEC_IDE)

These connectors are for Ultra DMA 133/100/66 signal cables. The Ultra DMA 133/100/66 signal cable has three connectors: a blue connector for the primary IDE connector on the motherboard, a black connector for an Ultra DMA 133/100/66 IDE slave device (optical drive/hard disk drive), and a gray connector for an Ultra DMA 133/100/66 IDE master device (hard disk drive). If you install two hard disk drives, you must configure the second drive as a slave device by setting its jumper accordingly. Refer to the hard disk documentation for the jumper settings.



- Pin 20 on the IDE connector is removed to match the covered hole on the Ultra DMA cable connector. This prevents incorrect insertion when you connect the IDE cable.
- Use the 80-conductor IDE cable for Ultra DMA 100/66 IDE devices.

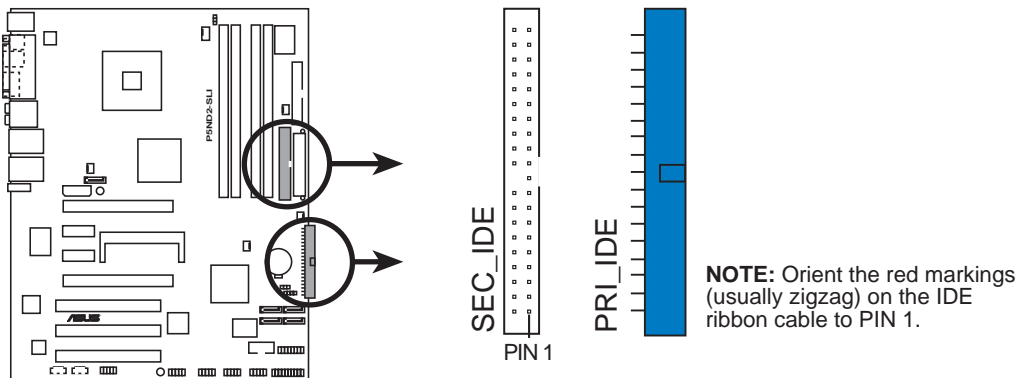

P5ND2-SLI DELUXE IDE connectors

4. Serial ATA connectors (7-pin SATA1 [blue], SATA2 [blue], SATA3 [blue], SATA4 [blue])

These connectors are for the Serial ATA signal cables for Serial ATA 3Gb/s hard disk and optical disk drives. The Serial ATA 3Gb/s is backward compatible with Serial ATA 1.5Gb/s specification.

If you installed Serial ATA hard disk drives, you can create a RAID 0, RAID 1, RAID 0+1, RAID 5 or JBOD configuration with the Primary and Secondary IDE drives through the onboard NVIDIA® MCP-04 RAID controller. Refer to section “5.4.2 NVIDIA® RAID configurations” on page 5-26 for details on how to set up Serial ATA RAID configurations.



These connectors are disabled by default. If you intend to create a Serial ATA RAID set using these connectors, enable the **First, Second, Third or Fourth SATA Master RAID** items in **Advanced > Onboard Devices Configuration > NVRAID Configuration** of the BIOS. See section “4.4.4 Onboard Devices Configuration” on page 4-23 for details.

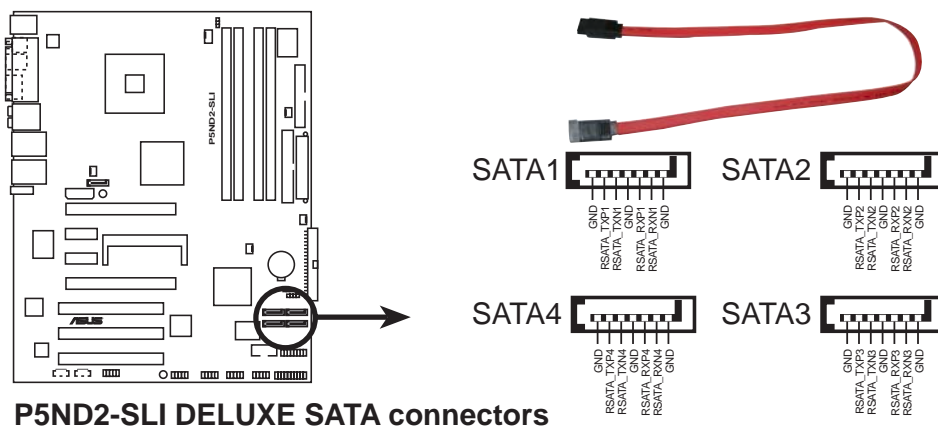

P5ND2-SLI DELUXE SATA connectors



These connectors support Native Command Queuing (NCQ), Power Management (PM) Implementation Algorithm, Hot Swap and smart setup.

5. Serial ATA RAID connector (7-pin SATA_RAID2)

This connector is for a Serial ATA signal cable. It supports a Serial ATA hard disk drive that you can combine with an external Serial ATA 3Gb/s device to configure a RAID 0 or RAID 1 set, through the onboard Silicon Image SATA RAID controller. Refer to Chapter 5 for details on how to set up Serial ATA RAID configurations.



See section “4.4.4 Onboard Devices Configuration” on page 4-23 for details.

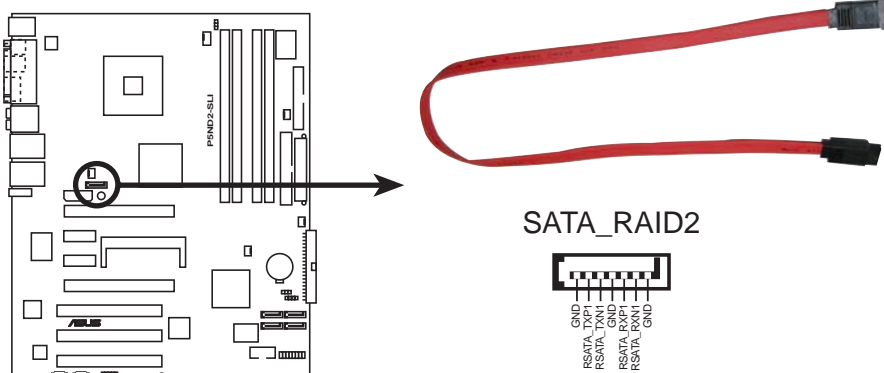

P5ND2-SLI DELUXE SATA RAID connector



- Before creating a RAID set using Serial ATA hard disks, make sure that you have connected the Serial ATA signal cable and installed Serial ATA hard disk drives; otherwise, you cannot enter the Silicon Image RAID utility and SATA BIOS setup during POST.
- Use a Serial ATA port multiplier if you want to configure a RAID 5, RAID 10 or CONCATENATION set.
- Use an external Serial ATA box if you want to configure a RAID 0 or RAID 1 set.
- The Serial ATA port multiplier and external Serial ATA box are purchased separately.



DO NOT unplug the external Serial ATA box when a RAID 0 or RAID 1 was configured.

7. Audio connectors (4-pin CD, AUX)

These connectors allow you to receive stereo audio input from sound sources such as a CD-ROM, TV-tuner, or MPEG card.

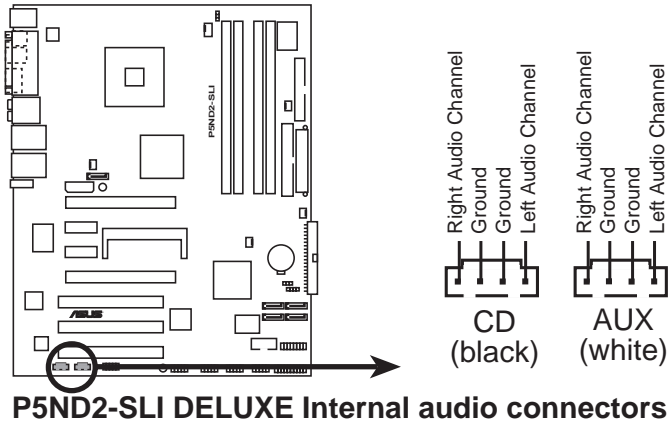

Due to system resource allocation, the function of the AUX connector is disabled under 8-channel mode.

8. Front panel audio connector (10-1 pin FP_AUDIO)

This connector is for a chassis-mounted front panel audio I/O module that supports legacy AC '97 audio standard. Connect one end of the front panel audio I/O module cable to this connector.

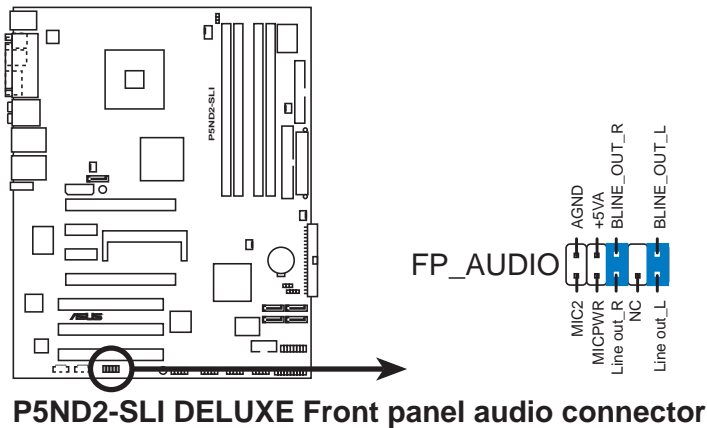

9. USB connectors (10-1 pin USB56, USB78, USB910)

These connectors are for USB 2.0 ports. Connect the USB/GAME module cable to any of these connectors, then install the module to a slot opening at the back of the system chassis. These USB connectors comply with USB 2.0 specification that supports up to 480 Mbps connection speed.

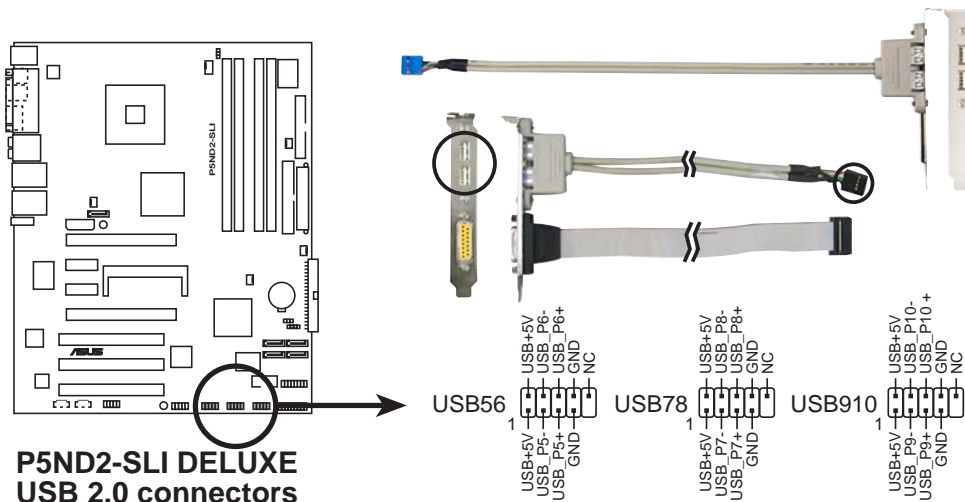

Never connect a **1394** cable to the USB connectors. Doing so will damage the motherboard!

10. IEEE 1394 port connector (10-1 pin IE1394_1)

This connector is for IEEE 1394 ports. Connect the IEEE 1394 module cable to this connector, then install the module to a slot opening at the back of the system chassis.

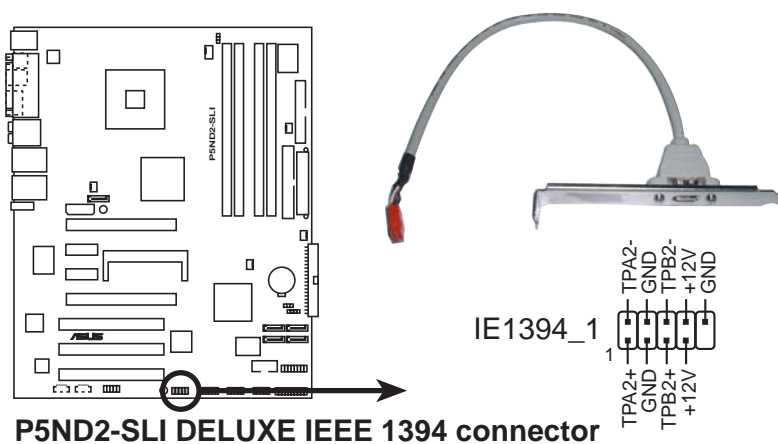

Never connect a **USB** cable to the IEEE 1394b connectors. Doing so will damage the motherboard!

11. GAME/MIDI port connector (16-1 pin GAME)

This connector is for a GAME/MIDI port. Connect the USB/GAME module cable to this connector, then install the module to a slot opening at the back of the system chassis. The GAME/MIDI port connects a joystick or game pad for playing games, and MIDI devices for playing or editing audio files.

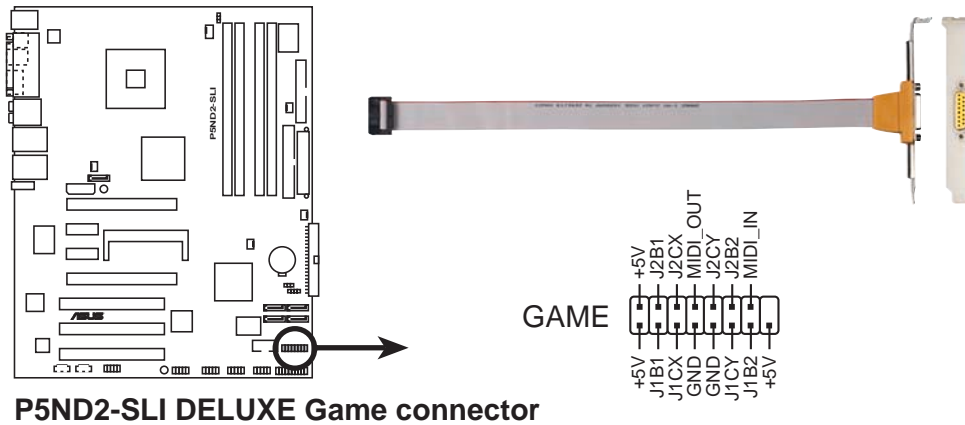

12. Serial port connector (10-1 pin COM1)

This connector is for a serial (COM) port. Connect the serial port module cable to this connector, then install the module to a slot opening at the back of the system chassis.

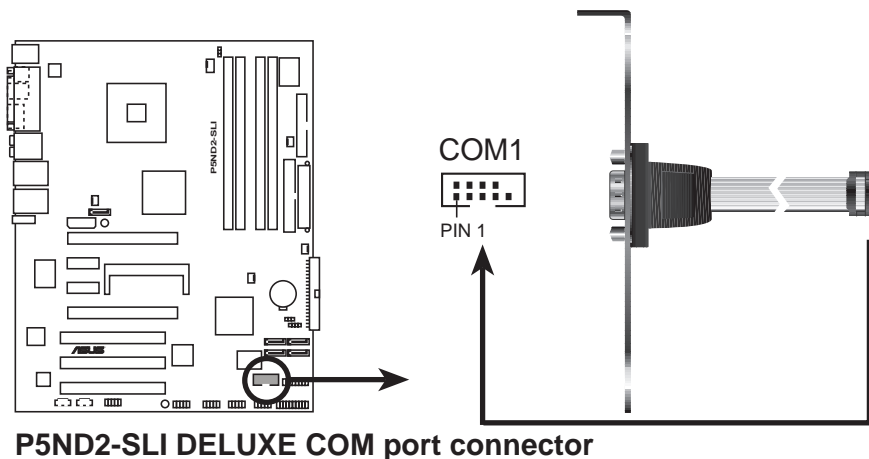

13. CPU, Chassis, NorthBridge, and Power Fan connectors (4-pin CPU_FAN, 3-pin PWR_FAN, 3-pin CHA_FAN1, 3-pin CHA_FAN2, 3-pin NB_FAN)

The fan connectors support cooling fans of 350 mA ~ 2000 mA (24 W max.) or a total of 1 A ~ 3.48 A (41.76 W max.) at +12V. Connect the fan cables to the fan connectors on the motherboard, making sure that the black wire of each cable matches the ground pin of the connector.



Do not forget to connect the fan cables to the fan connectors. Insufficient air flow inside the system may damage the motherboard components. These are not jumpers! Do not place jumper caps on the fan connectors!

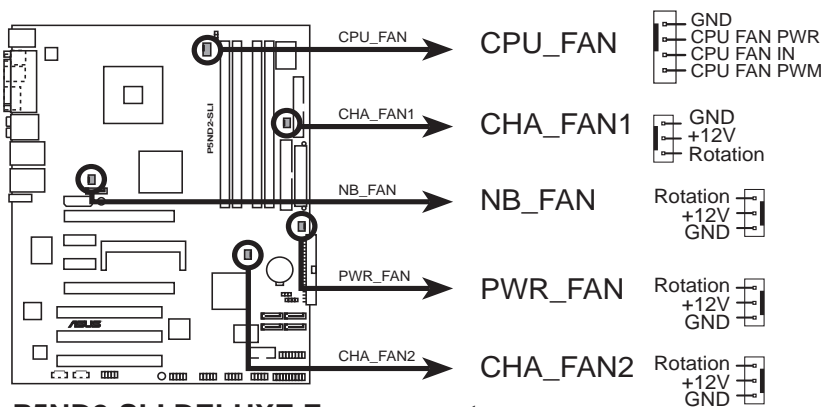

Only the CPU_FAN and CHA_FAN1 connectors support the ASUS Q-Fan 2 feature.



- Install an additional chassis fan when you are using two PCI Express graphics cards for better thermal environment.
- For some chassis models with short 3-pin chassis fan cable, connect the cable to the NB_FAN connector.

14. Chassis intrusion connector (4-1 pin CHASSIS)

This connector is for a chassis-mounted intrusion detection sensor or switch. Connect one end of the chassis intrusion sensor or switch cable to this connector. The chassis intrusion sensor or switch sends a high-level signal to this connector when a chassis component is removed or replaced. The signal is then generated as a chassis intrusion event.

By default, the pins labeled “Chassis Signal” and “Ground” are shorted with a jumper cap. Remove the jumper caps only when you intend to use the chassis intrusion detection feature.

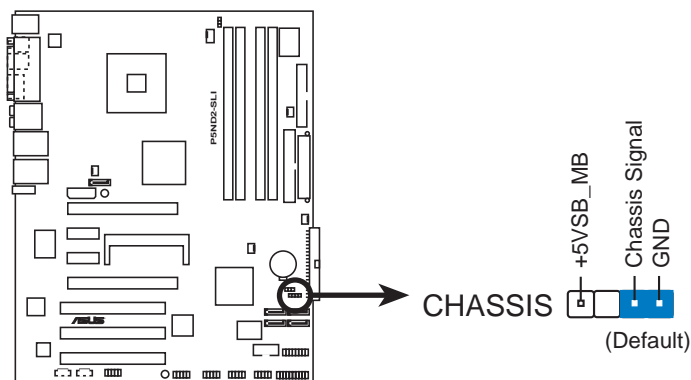

P5ND2-SLI DELUXE Chassis intrusion connector

15. ATX power connectors (24-pin EATXPWR, 4-pin ATX12V, 4-pin EZ_PLUG)

These connectors are for ATX power supply plugs. The power supply plugs are designed to fit these connectors in only one orientation. Find the proper orientation and push down firmly until the connectors completely fit.



- Do not forget to connect the 4-pin ATX +12 V power plug; otherwise, the system will not boot.
- When using two graphics cards, do not forget to connect the 4-pin ATX +12 V power plug to the EZ Plug™; otherwise, the system will be unstable. See page 6-x for details.
- Use of a PSU with a higher power output is recommended when configuring a system with more power-consuming devices. The system may become unstable or may not boot up if the power is inadequate.
- Make sure that your power supply unit (PSU) can provide at least the minimum power required by your system. See the table below for details.

Power supply requirements

| Components/Peripherals | Loading | | |
|---------------------------|-------------------|-------------------|-------------------|
| | Heavy | Normal | Light |
| Intel® LGA775 CPU type | Intel Pentium EE | Intel Pentium D | Intel Pentium 4 |
| PCIe™ x16 graphics cards | 6800 Ultra x2 | 6800GT x2 | 6600GT x2 |
| DDR DIMMs | 4 | 2 | 2 |
| HDD | 4 | 2 | 2 |
| Optical drive (DVD/CD-RW) | 2 | 2 | 1 |
| PCIe™ x 1 card | 1 | 0 | 0 |
| PCI cards | 3 | 2 | 1 |
| IEEE 1394 devices | 1 | 0 | 0 |
| USB devices | 6 | 4 | 3 |
| Required +12V current | > 25A | > 20A | > 17A |
| Required wattage | >= 500W | >= 400W | >= 350W |

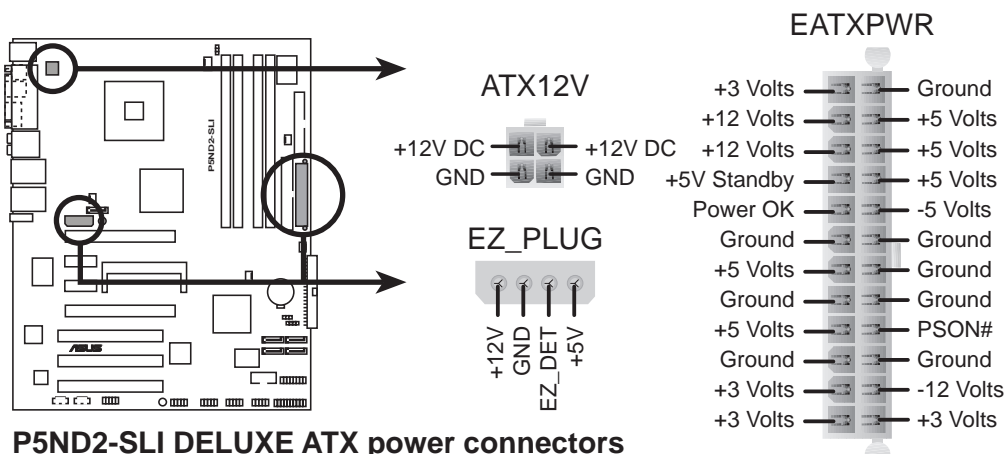

16. ASUS EZ selector card connector (144-pin SLI_CON)

This connector is for the ASUS proprietary ASUS EZ selector card that allows you to set the SLI mode to either Single Video card or Dual Video cards. See Chapter 6 for details.

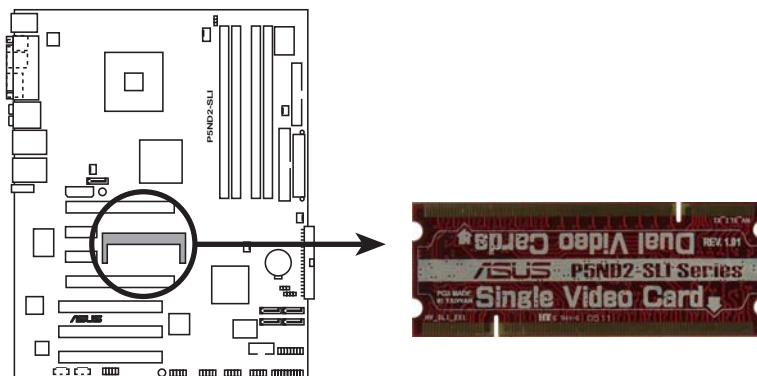

P5ND2-SLI DELUXE EZ selector card connector

17. System panel connector (20-pin PANEL)

This connector supports several chassis-mounted functions.

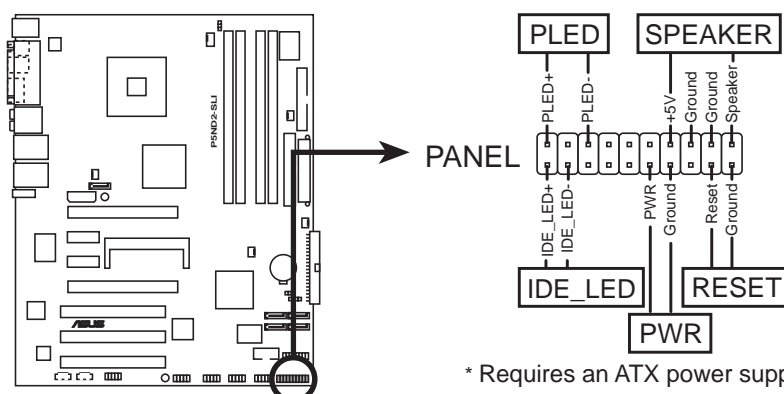

P5ND2-SLI DELUXE System panel connector



The system panel connector is color-coded for easy connection. Refer to the connector description below for details.

- **System power LED (Green 3-pin PLED)**

This 3-pin connector is for the system power LED. Connect the chassis power LED cable to this connector. The system power LED lights up when you turn on the system power, and blinks when the system is in sleep mode.

- **Hard disk drive activity LED (Red 2-pin IDE_LED)**
This 2-pin connector is for the HDD Activity LED. Connect the HDD Activity LED cable to this connector. The IDE LED lights up or flashes when data is read from or written to the HDD.
- **System warning speaker (Orange 4-pin SPEAKER)**
This 4-pin connector is for the chassis-mounted system warning speaker. The speaker allows you to hear system beeps and warnings.
- **ATX power button/soft-off button (Light Green 2-pin PWR)**
This connector is for the system power button. Pressing the power button turns the system on or puts the system in sleep or soft-off mode depending on the BIOS settings. Pressing the power switch for more than four seconds while the system is ON turns the system OFF.
- **Reset button (Blue 2-pin RESET)**
This 2-pin connector is for the chassis-mounted reset button for system reboot without turning off the system power.

This chapter describes the power up sequence, the vocal POST messages, and ways of shutting down the system.

Powering up

Chapter summary

3

| | | |
|-----|--------------------------------------|-----|
| 3.1 | Starting up for the first time | 3-1 |
| 3.2 | Powering off the computer | 3-2 |
| 3.3 | ASUS POST Reporter™ | 3-3 |

3.1 Starting up for the first time

1. After making all the connections, replace the system case cover.
2. Be sure that all switches are off.
3. Connect the power cord to the power connector at the back of the system chassis.
4. Connect the power cord to a power outlet that is equipped with a surge protector.
5. Turn on the devices in the following order:
 - a. Monitor
 - b. External SCSI devices (starting with the last device on the chain)
 - c. System power
6. After applying power, the system power LED on the system front panel case lights up. For systems with ATX power supplies, the system LED lights up when you press the ATX power button. If your monitor complies with “green” standards or if it has a “power standby” feature, the monitor LED may light up or switch between orange and green after the system LED turns on.

The system then runs the power-on self tests or POST. While the tests are running, the BIOS beeps (see BIOS beep codes table below) or additional messages appear on the screen. If you do not see anything within 30 seconds from the time you turned on the power, the system may have failed a power-on test. Check the jumper settings and connections or call your retailer for assistance.

7. At power on, hold down the <Delete> key to enter the BIOS Setup. Follow the instructions in Chapter 4.

3.2 Powering off the computer

3.2.1 Using the OS shut down function

If you are using Windows® 2000:

1. Click the **Start** button then click **Shut Down...**
2. Make sure that the **Shut Down** option button is selected, then click the **OK** button to shut down the computer.
3. The power supply should turn off after Windows® shuts down.

If you are using Windows® XP:

1. Click the **Start** button then select **Turn Off Computer.**
2. Click the **Turn Off** button to shut down the computer.
3. The power supply should turn off after Windows® shuts down.

3.2.2 Using the dual function power switch

While the system is ON, pressing the power switch for less than four seconds puts the system to sleep mode or to soft-off mode, depending on the BIOS setting. Pressing the power switch for more than four seconds lets the system enter the soft-off mode regardless of the BIOS setting. Refer to section “4.5 Power Menu” in Chapter 4 for details.

3.3 ASUS POST Reporter™

This motherboard includes the Winbond speech controller to support a special feature called the ASUS POST Reporter™. This feature lets you hear vocal messages during POST that alerts you of system events and boot status. In case of a boot failure, you will hear the specific cause of the problem.

These POST messages are customizable using the Winbond Voice Editor software that came with your package. You can record your own messages to replace the default messages.

3.3.1 Vocal POST messages

Following is a list of the default POST messages and the corresponding actions you can take:

| POST Message | Action |
|---------------------------|-------------------------------------------------------------------------------------------------------------------------------------------------------------------------------------------------------------------------------------------------------------------------------------------------------------------------------|
| No CPU installed | <ul style="list-style-type: none">• Install a supported processor to the CPU socket. See section “2.3 Central Processing Unit (CPU)” for details. |
| System failed CPU test | <ul style="list-style-type: none">• Check the CPU if properly installed.• Call ASUS technical support for assistance. See the ASUS contact information on the inside front cover of this user guide. |
| System failed memory test | <ul style="list-style-type: none">• Install supported DDR2 DIMMs into the memory sockets.• Check if the DIMMs on the DIMM sockets are properly installed.• Make sure that your DIMMs are not defective.• Refer to section “2.4 System memory” for instructions on installing a DIMM. |
| System failed VGA test | <ul style="list-style-type: none">• Install a PCI graphics card into one of the PCI slots, or a PCI Express AGP card into the PCI Express x16 slot.• Make sure that your graphics card is not defective. |
| System failed due to CPU | <ul style="list-style-type: none">• Check your CPU overclocking settings in the BIOS setup and restore the default CPU parameters. |
| No keyboard detected | <ul style="list-style-type: none">• Check if your keyboard is properly connected to the purple PS/2 connector on the rear panel.• See section “2.7.1 Rear panel connectors” for the location of the connector. |
| No IDE hard disk detected | <ul style="list-style-type: none">• Make sure you have connected an IDE hard disk drive to one of the IDE connectors on the motherboard. |

| POST Message | Action |
|--------------------------------------------|--------------------------------------------------------------------------------------------------------------------------------------------------------------------------------------------------------------------------------------------------------|
| CPU temperature too high | <ul style="list-style-type: none"> • Check if the CPU fan is working properly. |
| CPU fan failed | <ul style="list-style-type: none"> • Check the CPU fan and make sure it turns on after you apply power to the system. • Make sure that your CPU fan supports the fan speed detection function. |
| CPU voltage out of range | <ul style="list-style-type: none"> • Check your power supply and make sure it is not defective. • Call ASUS technical support for assistance. See the “ASUS contact information” on the inside front cover of this user guide. |
| Computer now booting from operating system | <ul style="list-style-type: none"> • No action required |



You can enable or disable the ASUS POST Reporter™ in the **Speech Configuration** option in the BIOS setup. See section 4.4.8 for details.

3.3.2 Winbond Voice Editor

The Winbond Voice Editor software allows you to customize the vocal POST messages. You can install this application from the support CD.



To avoid conflicts, do not run the Winbond Voice Editor while running the ASUS PC Probe application.

Launching the Voice Editor

You can launch the program from the Windows® desktop by clicking **Start > All Programs > Winbond Voice Editor > Voice Editor**.

The Winbond Voice Editor screen appears.

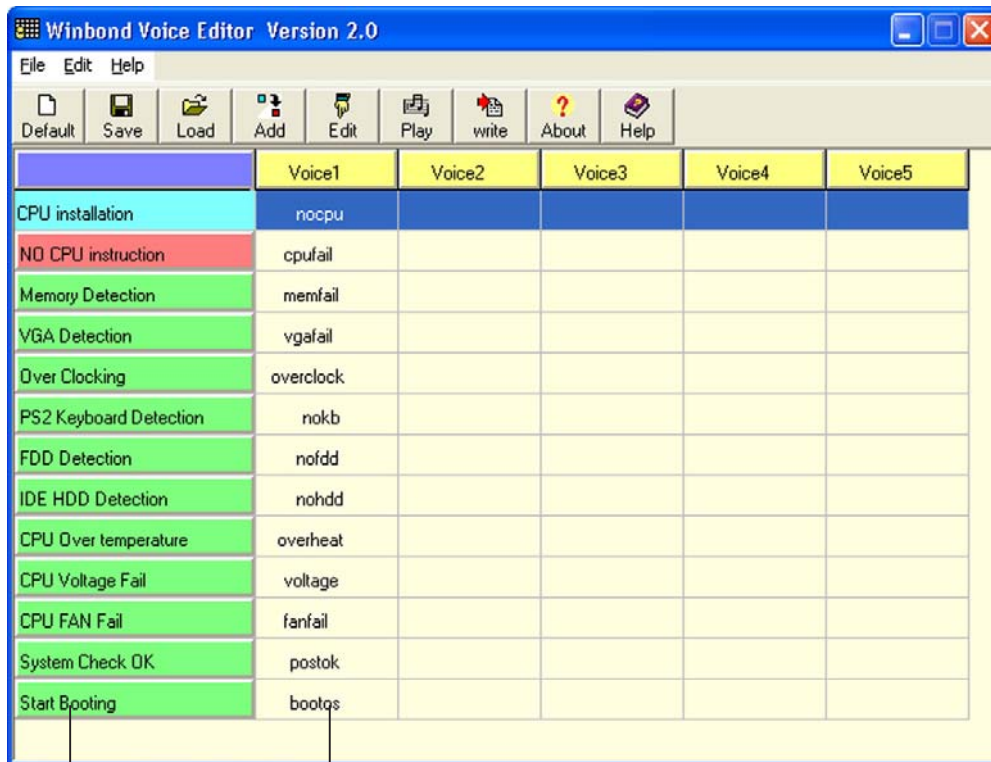

POST Events Default Messages

Playing the default wave files

To play the default wave files, simply click on a POST event on the left side of the screen, then click the Play button.



The default language setting is English.

Changing the default language

To change the default language:

1. Click the **Load** button from the Voice Editor main window. A window with the available languages appears.

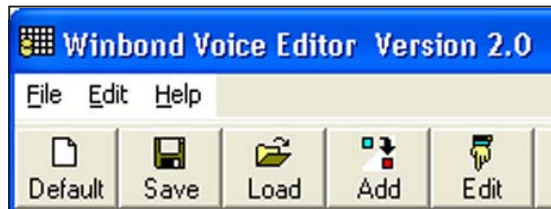

2. Select your desired language, then click **Open**.
The event messages for the language you selected appear on the Voice Editor main window.

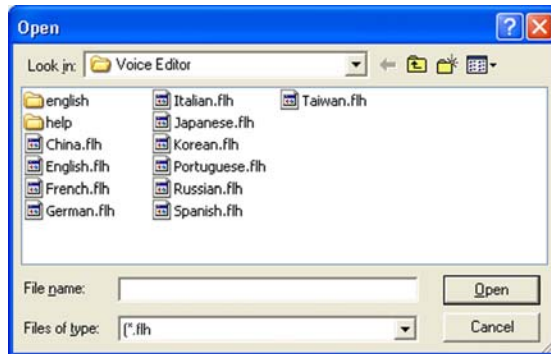

Not all events on some languages have a corresponding message due to file size constraints.

3. Click the **Write** button from the Voice Editor main window to update the EEPROM.
4. Click **Yes** to confirm.

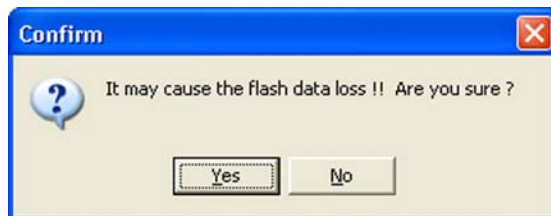

The next time you boot your computer, the ASUS Post Reporter announces the messages in the selected language.

Customizing your POST messages

The Voice Editor application allows you to record your own POST messages if your language is not supported or if you wish to replace the pre-installed wave files.

To customize your POST messages.

1. Launch the Voice Editor application and note the list of POST events on the leftmost column of the screen.
2. Prepare your message for each event.
3. Use a recording software (e.g. Windows® Recorder) to record your messages, then save the messages as wave files (.WAV).



- The total compressed size for all the wave files must not exceed 1Mbit, so keep your messages as short as possible.
- To keep file sizes small, save your files at a low quality. For example, use 8-bit, mono quality at 22Khz sampling rate.
- Create a separate folder for your wave files so you can locate them easily.

4. From the Voice Editor screen, click the **Add** button to display the **Add Wave File** window.
5. Copy the wave files that you recorded to the database, then close the window when done.

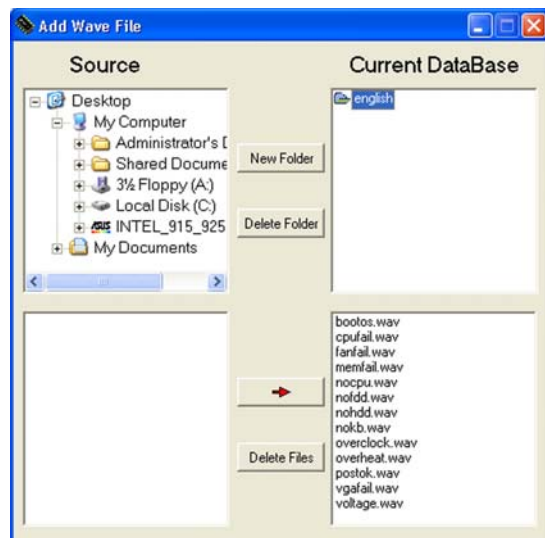

6. Select a POST event on the Voice Editor main window, then click the **Edit** button. The **Event Sound Editor** window appears.
7. Locate and select your wave file for the event, then click on the arrow opposite Voice1. The file you select appears on the space next to it.
8. Click **OK** to return to the Voice Editor main window.
9. Do steps 6 to 8 for the other events.

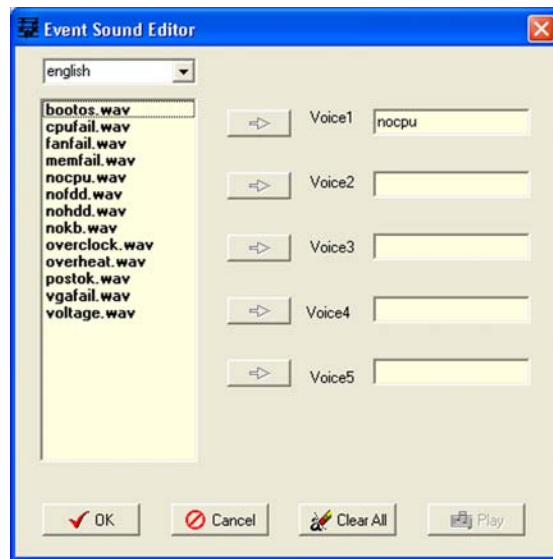

10. When done, click **Save**. A window appears prompting you to save your configuration.
11. Type a file name with an **.flh** extension, then click Save.

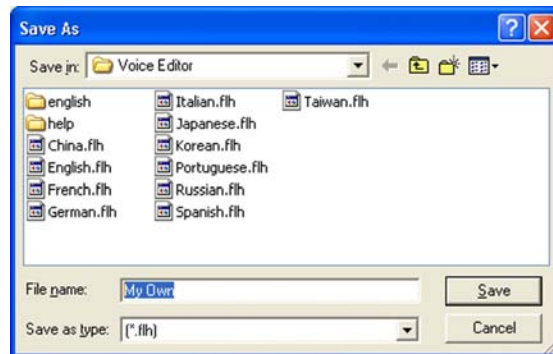

12. Click the **Write** button to compress the file and copy into the EEPROM.
13. Click **Yes** on the confirmation window that appears.

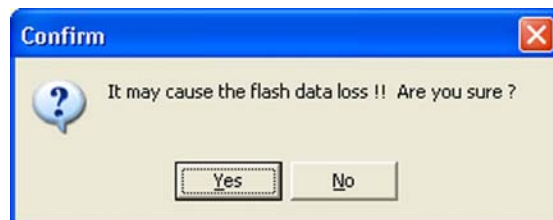

If you receive an error message telling you that the files exceed the total allowable size, do any or all of the following:

- Shorten your messages.
- Save the wave files at a lower quality
- Do not include seldom-used events like FDD Detection, IDE HDD Detection, etc.

This chapter tells how to change the system settings through the BIOS Setup menus. Detailed descriptions of the BIOS parameters are also provided.

BIOS setup

Chapter summary

| | | |
|-----|---------------------------------------|------|
| 4.1 | Managing and updating your BIOS | 4-1 |
| 4.2 | BIOS setup program | 4-11 |
| 4.3 | Main menu | 4-15 |
| 4.4 | Advanced menu | 4-20 |
| 4.5 | Power menu | 4-40 |
| 4.6 | Boot menu | 4-44 |
| 4.7 | Exit menu | 4-50 |

4.1 Managing and updating your BIOS

The following utilities allow you to manage and update the motherboard Basic Input/Output System (BIOS) setup.

1. **Award BIOS Flash Utility** (Updates the BIOS in DOS mode using a bootable floppy disk.)
2. **ASUS CrashFree BIOS 2** (Updates the BIOS using a bootable floppy disk or the motherboard support CD when the BIOS file fails or gets corrupted.)
3. **ASUS EZ Flash** (Updates the BIOS in DOS using a floppy disk or the motherboard support CD.)
4. **ASUS Update** (Updates the BIOS in Windows® environment.)

Refer to the corresponding sections for details on these utilities.



Save a copy of the original motherboard BIOS file to a bootable floppy disk in case you need to restore the BIOS in the future. Copy the original motherboard BIOS using the ASUS Update or AwardBIOS Flash utilities.

4.1.1 Creating a bootable floppy disk

1. Do either one of the following to create a bootable floppy disk.

DOS environment

- a. Insert a 1.44MB floppy disk into the drive.
- b. At the DOS prompt, type `format A:/S` then press <Enter>.

Windows® XP environment

- a. Insert a 1.44 MB floppy disk to the floppy disk drive.
- b. Click **Start** from the Windows® desktop, then select **My Computer**.
- c. Select the 3 1/2 Floppy Drive icon.
- d. Click **File** from the menu, then select **Format**. A **Format 3 1/2 Floppy Disk** window appears.
- e. Select **Create an MS-DOS startup disk** from the format options field, then click **Start**.

Windows® 2000 environment

To create a set of boot disks for Windows® 2000:

- a. Insert a formatted, high density 1.44 MB floppy disk into the drive.
- b. Insert the Windows® 2000 CD to the optical drive.

- c. Click **Start**, then select **Run**.
 - d. From the Open field, type
`D:\bootdisk\makeboot a:`
assuming that D: is your optical drive.
 - e. Press <Enter>, then follow screen instructions to continue.
2. Copy the original or the latest motherboard BIOS file to the bootable floppy disk.

4.1.2 Updating the BIOS

The Basic Input/Output System (BIOS) can be updated using the AwardBIOS Flash Utility. Follow these instructions to update the BIOS using this utility.

1. Download the latest BIOS file from the ASUS web site. Rename the file to **A8NSLI-B.BIN** and save it to a floppy disk.



Save only the updated BIOS file in the floppy disk to avoid loading the wrong BIOS file.

2. Copy the AwardBIOS Flash Utility (awdfash.exe) from the Software folder of the support CD to the floppy disk with the latest BIOS file.
3. Boot the system in DOS mode using the bootable floppy disk you created earlier.
4. When the **A:>** appears, replace the bootable floppy disk with the floppy disk containing the new BIOS file and the Award BIOS Flash Utility.
5. At the prompt, type **awdfash** then press <Enter>. The Award BIOS Flash Utility screen appears.

```
AwardBIOS Flash Utility for ASUS V1.08
(C) Phoenix Technologies Ltd. All Rights Reserved

For NF-KC804-P5ND2-SLI-00      DATE: 03/25/2005
Flash Type - SST 49LF004A/B /3.3V

File Name to Program: 

Message: Please input File Name!
```

4.1.4 ASUS CrashFree BIOS 2 utility

The ASUS CrashFree BIOS 2 is an auto recovery tool that allows you to restore the BIOS file when it fails or gets corrupted during the updating process. You can update a corrupted BIOS file using the motherboard support CD or the floppy disk that contains the updated BIOS file.



Prepare the motherboard support CD or the floppy disk containing the updated motherboard BIOS before using this utility.

Recovering the BIOS from the support CD

To recover the BIOS from the support CD:

1. Turn on the system.
2. Insert the motherboard support CD to the optical drive.
3. The utility displays the following message and automatically checks the CD for the BIOS file.

```
Award BootBlock BIOS v1.0
Copyright (c) 2000, Award Software, Inc.

BIOS ROM checksum error
Detecting IDE ATAPI device...
```

When found, the utility reads the BIOS file and starts flashing the corrupted BIOS file.

```
Award BootBlock BIOS v1.0
Copyright (c) 2000, Award Software, Inc.

BIOS ROM checksum error
Detecting IDE ATAPI device...
Found CDROM, try to Boot from it... Pass
```



DO NOT shut down or reset the system while updating the BIOS! Doing so can cause system boot failure!

4. Restart the system after the utility completes the updating process.

Recovering the BIOS from a floppy disk

To recover the BIOS from the support CD:

1. Remove any CD from the optical drive, then turn on the system.
2. Insert the floppy disk with the original or updated BIOS file to the floppy disk drive.
3. The utility displays the following message and automatically checks the floppy disk for the original or updated BIOS file.

```
Award BootBlock BIOS v1.0
Copyright (c) 2000, Award Software, Inc.

BIOS ROM checksum error
Detecting IDE ATAPI device...
```

When no CD is found, the utility automatically checks the optical drive for the original or updated BIOS file. The utility then updates the corrupted BIOS file.

```
Award BootBlock BIOS v1.0
Copyright (c) 2000, Award Software, Inc.

BIOS ROM checksum error
Detecting IDE ATAPI device...
  Found CDROM, try to Boot from it... Fail

Detecting floppy drive A media...
```



DO NOT shut down or reset the system while updating the BIOS! Doing so can cause system boot failure!

4. Restart the system after the utility completes the updating process.



The recovered BIOS may not be the latest BIOS version for this motherboard. Visit the ASUS website (www.asus.com) to download the latest BIOS file.

4.1.5 ASUS EZ Flash utility

The ASUS EZ Flash feature allows you to update the BIOS without having to go through the long process of booting from a floppy disk and using a DOS-based utility. The EZ Flash utility is built-in the BIOS chip so it is accessible by pressing <Alt> + <F2> during the Power-On Self Tests (POST).

To update the BIOS using EZ Flash:

1. Visit the ASUS website (www.asus.com) to download the latest BIOS file for the motherboard.
2. Save the BIOS file to a floppy disk, then restart the system.
3. Press <Alt> + <F2> during POST to display the following.

```
Insert Disk then press Enter or ESC to continue POST
```

4. Insert the floppy disk that contains the BIOS file to the floppy disk drive then press <Enter>. The following screen appears.

```
AwardBIOS Flash Utility for ASUS V1.08
(C) Phoenix Technologies Ltd. All Rights Reserved

For NF-KC804-P5ND2-SLI-00      DATE: 03/25/2005
Flash Type - SST 49LF004A/B /3.3V

File Name to Program: 

Message: Please wait...
```

5. When the correct BIOS file is found, EZ Flash performs the BIOS update process and automatically reboots the system when done.



Do not shutdown or reset the system while updating the BIOS to prevent system boot failure!

4.1.6 ASUS Update utility

The ASUS Update is a utility that allows you to manage, save, and update the motherboard BIOS in Windows® environment. The ASUS Update utility allows you to:

- Save the current BIOS file
- Download the latest BIOS file from the Internet
- Update the BIOS from an updated BIOS file
- Update the BIOS directly from the Internet, and
- View the BIOS version information.

This utility is available in the support CD that comes with the motherboard package.



ASUS Update requires an Internet connection either through a network or an Internet Service Provider (ISP).

Installing ASUS Update

To install ASUS Update:

1. Place the support CD in the optical drive. The **Drivers** menu appears.
2. Click the **Utilities** tab, then click **Install ASUS Update VX.XX.XX**. See page 5-3 for the **Utilities** screen menu.
3. The ASUS Update utility is copied to your system.



Quit all Windows® applications before you update the BIOS using this utility.

Updating the BIOS through the Internet

To update the BIOS through the Internet:

1. Launch the ASUS Update utility from the Windows® desktop by clicking **Start > Programs > ASUS > ASUSUpdate > ASUSUpdate**. The ASUS Update main window appears.

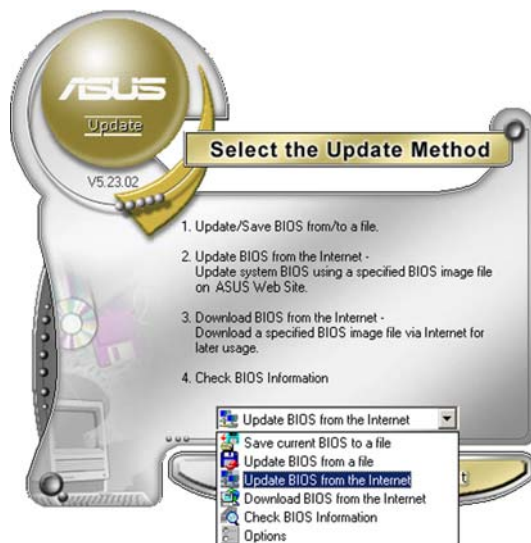
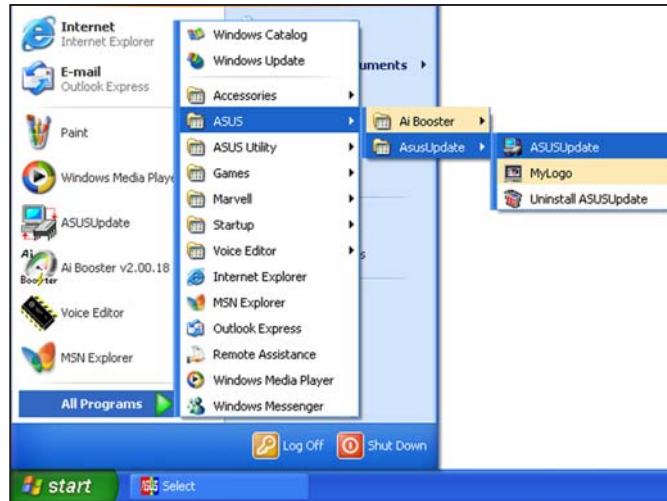

2. Select **Update BIOS from the Internet** option from the drop-down menu, then click **Next**.



3. Select the ASUS FTP site nearest you to avoid network traffic, or click **Auto Select**. Click **Next**.

- From the FTP site, select the BIOS version that you wish to download. Click Next.
- Follow the screen instructions to complete the update process.



The ASUS Update utility is capable of updating itself through the Internet. Always update the utility to avail all its features.



Updating the BIOS through a BIOS file

To update the BIOS through a BIOS file:

- Launch the ASUS Update utility from the Windows® desktop by clicking **Start > Programs > ASUS > ASUSUpdate > ASUSUpdate**. The ASUS Update main window appears.
- Select **Update BIOS from a file** option from the drop-down menu, then click **Next**.

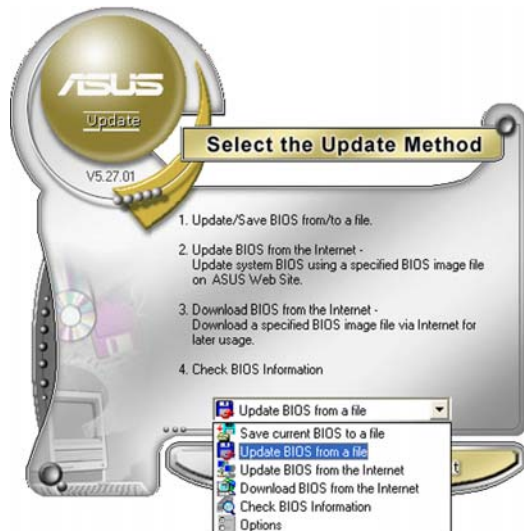

- Locate the BIOS file from the **Open** window, then click **Save**.
- Follow the screen instructions to complete the update process.

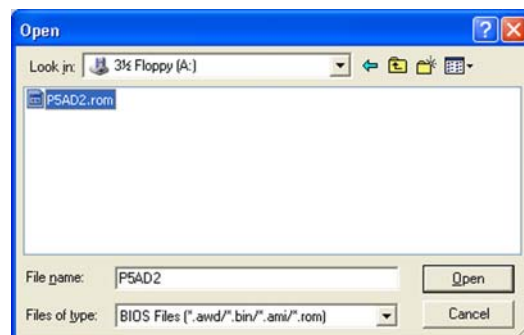

4.2 BIOS setup program

This motherboard supports a programmable Low-Pin Count (LPC) chip that you can update using the provided utility described in section “4.1 Managing and updating your BIOS.”

Use the BIOS Setup program when you are installing a motherboard, reconfiguring your system, or prompted to “Run Setup”. This section explains how to configure your system using this utility.

Even if you are not prompted to use the Setup program, you can change the configuration of your computer in the future. For example, you can enable the security password feature or change the power management settings. This requires you to reconfigure your system using the BIOS Setup program so that the computer can recognize these changes and record them in the CMOS RAM of the LPC chip.

The LPC chip on the motherboard stores the Setup utility. When you start up the computer, the system provides you with the opportunity to run this program. Press during the Power-On Self-Test (POST) to enter the Setup utility; otherwise, POST continues with its test routines.

If you wish to enter Setup after POST, restart the system by pressing <Ctrl+Alt+Delete>, or by pressing the reset button on the system chassis. You can also restart by turning the system off and then back on. Do this last option only if the first two failed.

The Setup program is designed to make it as easy to use as possible. Being a menu-driven program, it lets you scroll through the various sub-menus and make your selections from the available options using the navigation keys.



-
- The default BIOS settings for this motherboard apply for most conditions to ensure optimum performance. If the system becomes unstable after changing any BIOS settings, load the default settings to ensure system compatibility and stability. Select the **Load Default Settings** item under the Exit Menu. See section “4.7 Exit Menu.”
 - The BIOS setup screens shown in this section are for reference purposes only, and may not exactly match what you see on your screen.
 - Visit the ASUS website (www.asus.com) to download the latest BIOS file for this motherboard and .
-

4.2.1 BIOS menu screen

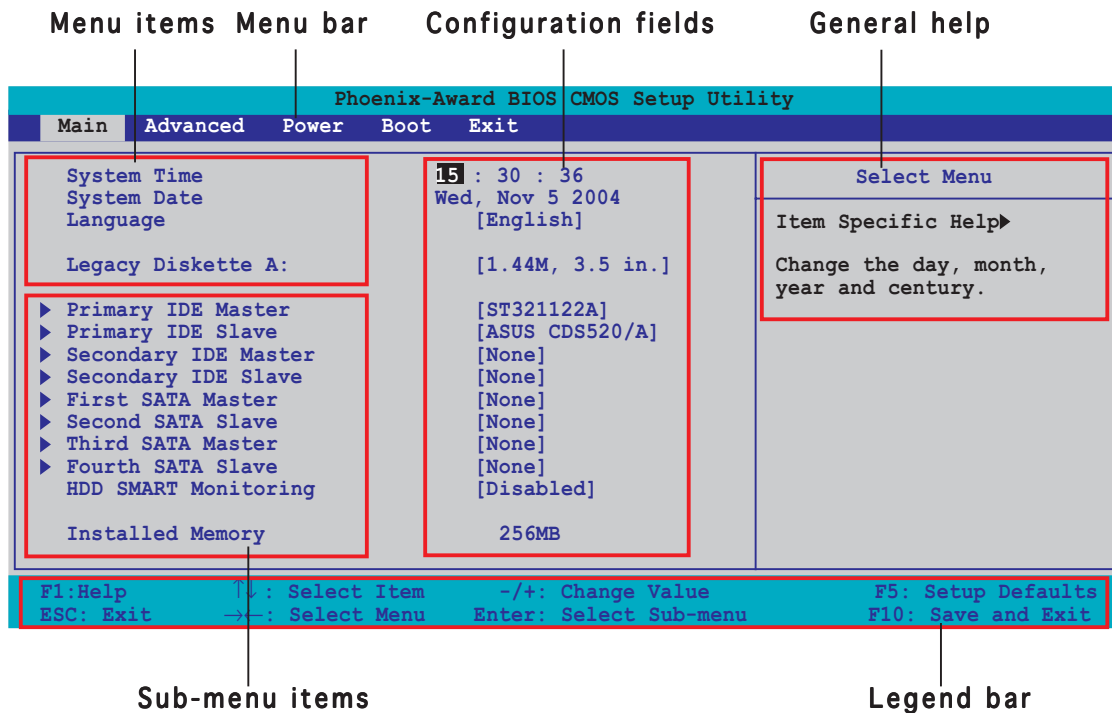

4.2.2 Menu bar

The menu bar on top of the screen has the following main items:

- Main** For changing the basic system configuration
- Advanced** For changing the advanced system settings
- Power** For changing the advanced power management (APM) configuration
- Boot** For changing the system boot configuration
- Exit** For selecting the exit options and loading default settings

To select an item on the menu bar, press the right or left arrow key on the keyboard until the desired item is highlighted.



- The BIOS setup screens shown in this chapter are for reference purposes only, and may not exactly match what you see on your screen.
- Visit the ASUS website (www.asus.com) to download the latest BIOS information.

4.2.3 Legend bar

At the bottom of the Setup screen is a legend bar. The keys in the legend bar allow you to navigate through the various setup menus. The following table lists the keys found in the legend bar with their corresponding functions.

| Navigation Key | Function |
|------------------------|------------------------------------------------------------------|
| <F1> | Displays the General Help screen |
| <F5> | Loads setup default values |
| <Esc> | Exits the BIOS setup or returns to the main menu from a sub-menu |
| Left or Right arrow | Selects the menu item to the left or right |
| Up or Down arrow | Moves the highlight up or down between fields |
| Page Down or - (minus) | Scrolls backward through the values for the highlighted field |
| Page Up or + (plus) | Scrolls forward through the values for the highlighted field |
| <Enter> | Brings up a selection menu for the highlighted field |
| <F10> | Saves changes and exit |

4.2.4 Menu items

The highlighted item on the menu bar displays the specific items for that menu. For example, selecting **Main** shows the Main menu items.

The other items (Advanced, Power, Boot, and Exit) on the menu bar have their respective menu items.

4.2.5 Sub-menu items

A solid triangle before each item on any menu screen means that the item has a sub-menu. To display the sub-menu, select the item and press <Enter>.

4.2.6 Configuration fields

These fields show the values for the menu items. If an item is user-configurable, you can change the value of the field opposite the item. You cannot select an item that is not user-configurable.

A configurable field is enclosed in brackets, and is highlighted when selected. To change the value of a field, select it then press <Enter> to display a list of options. Refer to “4.2.7 Pop-up window.”

4.2.7 Pop-up window

Select a menu item then press <Enter> to display a pop-up window with the configuration options for that item.

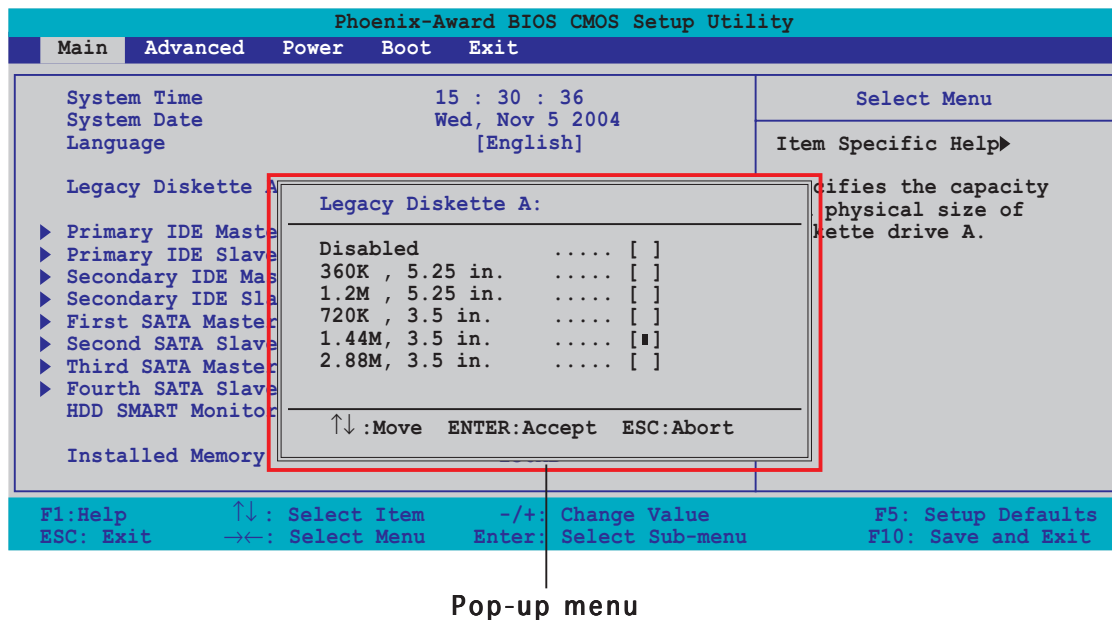

4.2.8 General help

At the top right corner of the menu screen is a brief description of the selected item.

4.3 Main menu

When you enter the BIOS Setup program, the Main menu screen appears, giving you an overview of the basic system information.



Refer to section “4.2.1 BIOS menu screen” for information on the menu screen items and how to navigate through them.

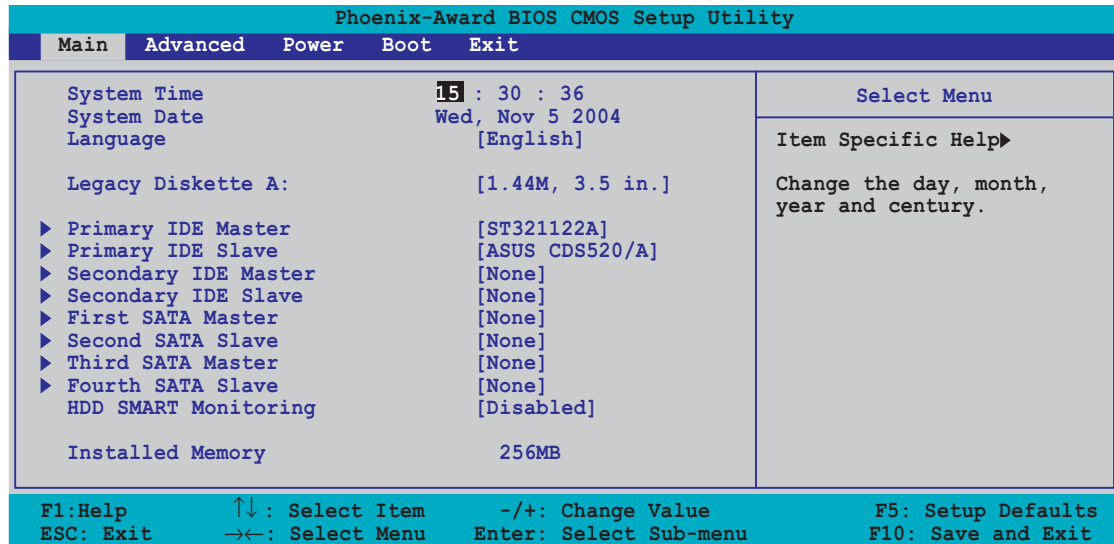

4.3.1 System Time [xx:xx:xxxx]

Allows you to set the system time.

4.3.2 System Date [Day xx/xx/xxxx]

Allows you to set the system date.

4.3.3 Language [English]

Allows you to choose the BIOS language version from the options.

Configuration options: [Français] [German] [English]

4.3.4 Legacy Diskette A [1.44M, 3.5 in.]

Sets the type of floppy drive installed. Configuration options: [Disabled]

[360K, 5.25 in.] [1.2M , 5.25 in.] [720K , 3.5 in.] [1.44M, 3.5 in.]

[2.88M, 3.5 in.]

4.3.5 Primary and Secondary IDE Master/Slave

While entering Setup, the BIOS automatically detects the presence of IDE devices. There is a separate sub-menu for each IDE device. Select a device item then press <Enter> to display the IDE device information.

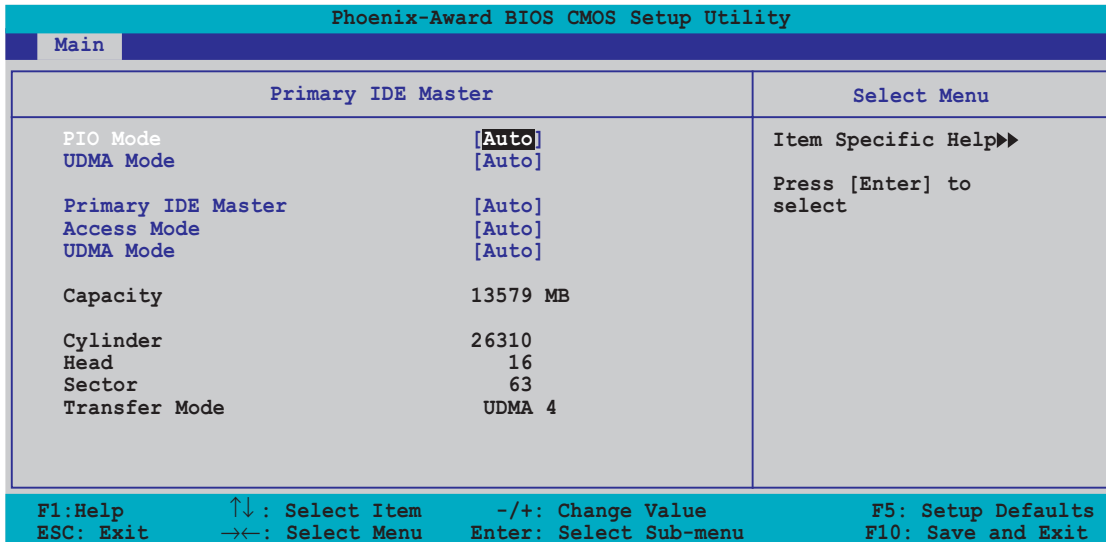

The BIOS automatically detects the values opposite the dimmed items (Capacity, Cylinder, Head, Sector and Transfer Mode). These values are not user-configurable. These items show N/A if no IDE device is installed in the system.

PIO Mode

Sets the PIO mode for the IDE device.

Configuration options: [Auto] [Mode 0] [Mode 1] [Mode 2] [Mode 3] [Mode 4]

UDMA Mode

Disables or sets the UDMA mode. Configuration options: [Disabled] [Auto]

IDE Primary Master/Slave [Auto]; IDE Secondary Master/Slave [Auto]

Select [Auto] to automatically detect an IDE hard disk drive. If automatic detection is successful, the BIOS automatically fills in the correct values for the remaining fields on this sub-menu. If the hard disk was already formatted on a previous system, the setup BIOS may detect incorrect parameters. Select [Manual] to manually enter the IDE hard disk drive parameters. If no drive is installed select [None].

Configuration options: [None] [Auto] [Manual]

Access Mode [Auto]

The default [Auto] allows automatic detection of an IDE hard disk drive. Select [CHS] for this item if you set the IDE Primary Master/Slave to [Manual]. Configuration options: [CHS] [LBA] [Large] [Auto]



Before attempting to configure a hard disk drive, make sure you have the correct configuration information supplied by the drive manufacturer. Incorrect settings may cause the system to fail to recognize the installed hard disk.

Capacity

Displays the auto-detected hard disk capacity. This item is not configurable.

Cylinder

Shows the number of the hard disk cylinders. This item is not configurable.

Head

Shows the number of the hard disk read/write heads. This item is not configurable.

Sector

Shows the number of sectors per track. This item is not configurable.

Transfer Mode

Shows the Transfer mode. This item is not configurable.



After entering the IDE hard disk drive information into BIOS, use a disk utility, such as FDISK, to partition and format new IDE hard disk drives. This is necessary so that you can write or read data from the hard disk. Make sure to set the partition of the Primary IDE hard disk drives to active.

4.3.6 First, Second, Third, Fourth SATA Master

While entering Setup, the BIOS automatically detects the presence of Serial ATA devices. There is a separate sub-menu for each SATA device. Select a device item then press <Enter> to display the SATA device information.

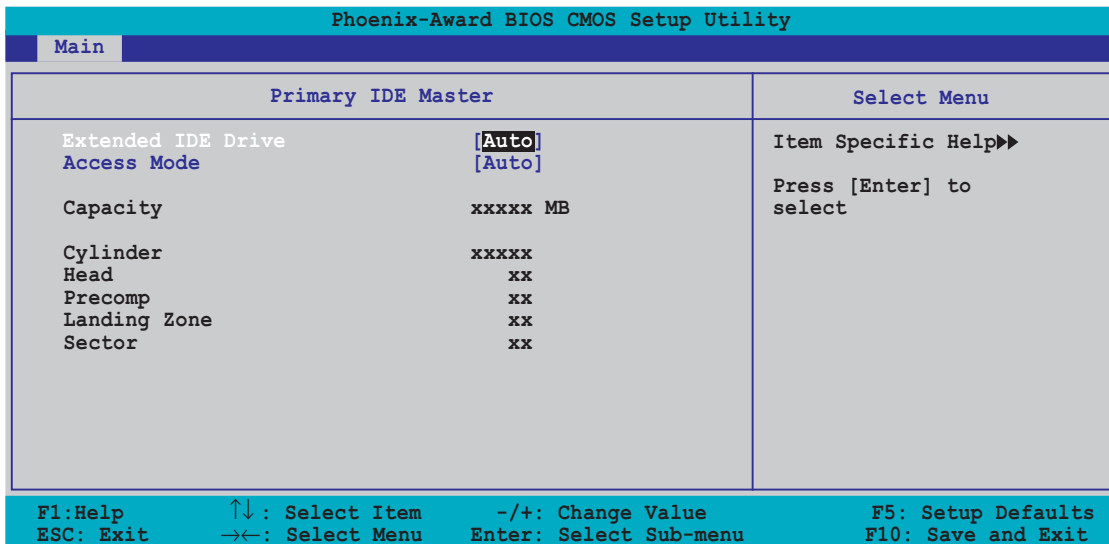

The BIOS automatically detects the values opposite the dimmed items (Capacity, Cylinder, Head, Precomp, Landing Zone and Sector). These values are not user-configurable. These items show 0 if no SATA device is installed in the system.

Extended Drive

Selects the type of fixed disk connected to the system.

Configuration options: [None] [Auto]

Access Mode

Sets the sector addressing mode. Configuration options: [Large] [Auto]



Before attempting to configure a hard disk drive, make sure you have the correct configuration information supplied by the drive manufacturer. Incorrect settings may cause the system to fail to recognize the installed hard disk.

Capacity

Displays the auto-detected hard disk capacity. This item is not configurable.

Cylinder

Shows the number of the hard disk cylinders. This item is not configurable.

Head

Shows the number of the hard disk read/write heads. This item is not configurable.

Precomp

Shows the number of precomp per track. This item is not configurable.

Landing Zone

Shows the number of landing zone per track. This item is not configurable.

Sector

Shows the number of sectors per track. This item is not configurable.



After entering the IDE hard disk drive information into BIOS, use a disk utility, such as FDISK, to partition and format new IDE hard disk drives. This is necessary so that you can write or read data from the hard disk. Make sure to set the partition of the Primary IDE hard disk drives to active.

4.3.7 HDD SMART Monitoring

Allows you to enable or disable the HDD Self-Monitoring Analysis and Reporting Technology (SMART) feature.

Configuration options: [Disabled] [Enabled]

4.3.8 Installed Memory

Shows the size of installed memory.

4.4 Advanced menu

The Advanced menu items allow you to change the settings for the CPU and other system devices.



Take caution when changing the settings of the Advanced menu items. Incorrect field values can cause the system to malfunction.

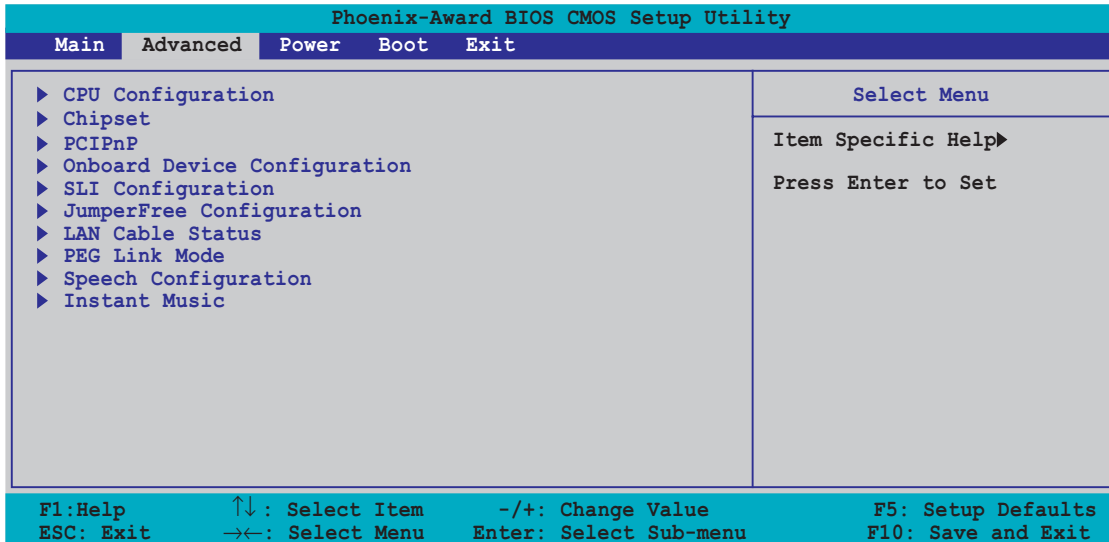

4.4.1 CPU Configuration

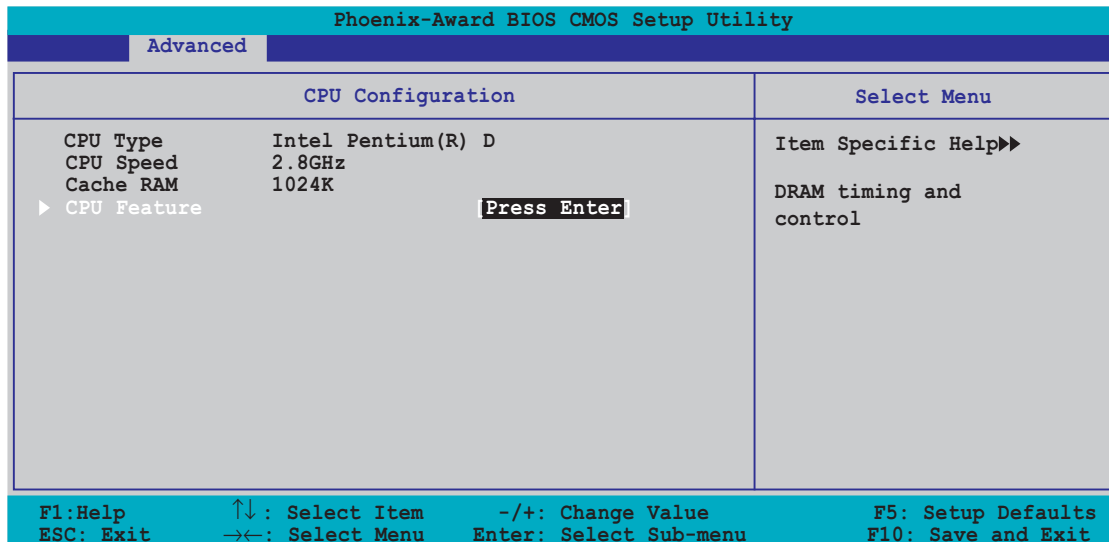

CPU Feature

The items in this sub-menu show the CPU-related information auto-detected by the BIOS.

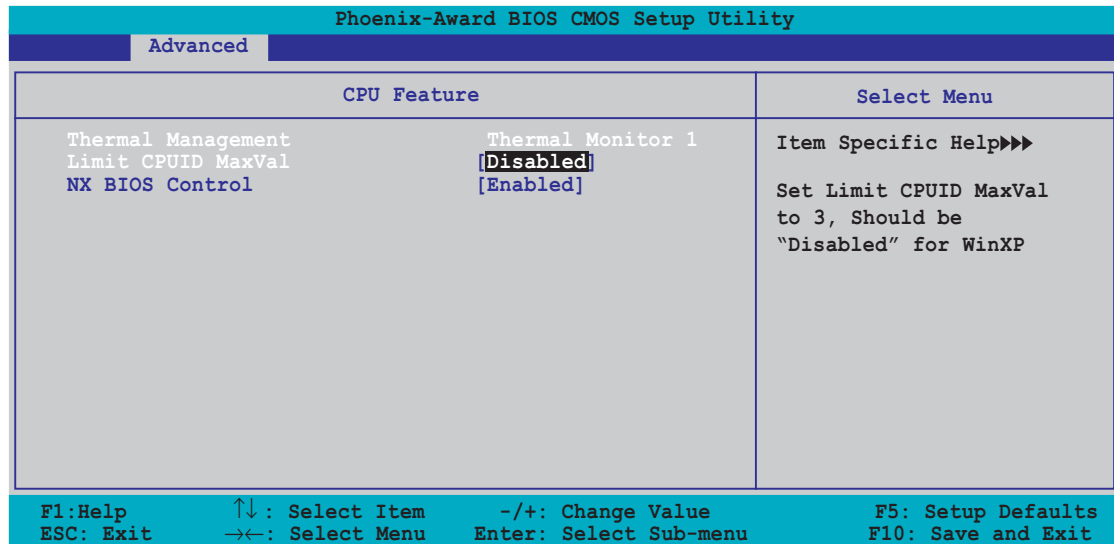

Limit CPUID MaxVal [Disabled]

Enables or disables the CPU ID maximum value limit.

Configuration options: [Disabled] [Enabled]

NX BIOS Control [Enabled]

Enables or disables the NX BIOS control. When disabled, the BIOS forces the NX feature flag to always return 0.

Configuration options: [Disabled] [Enabled]

4.4.2 Chipset

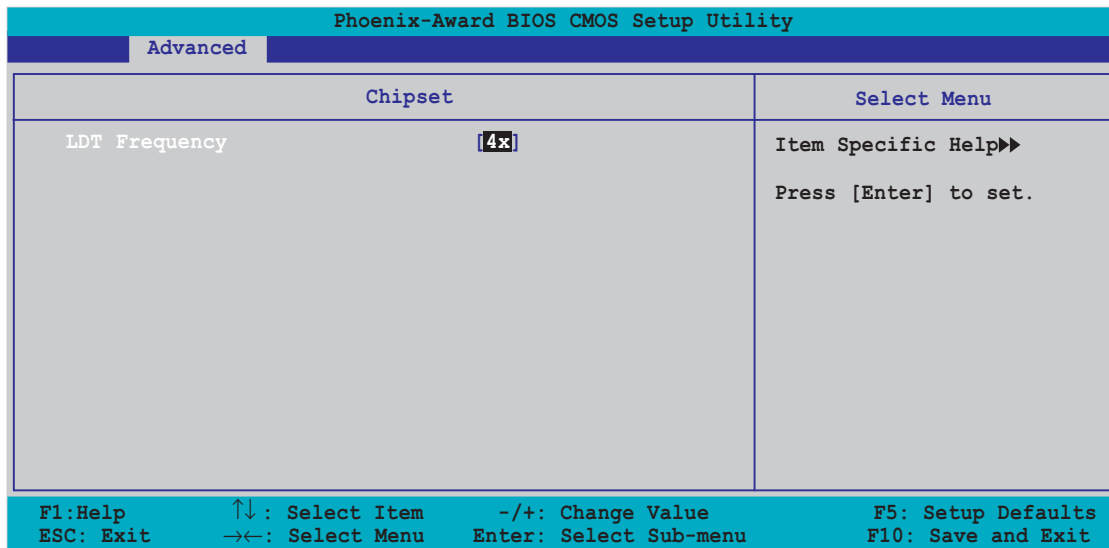

LDT Frequency [4x]

Sets the Lightning Data Transport (LDT) frequency multiplier.
Configuration options: [1x] [2x] [3x] [4x] [5x] [3.5x]

4.4.3 PCIPnP

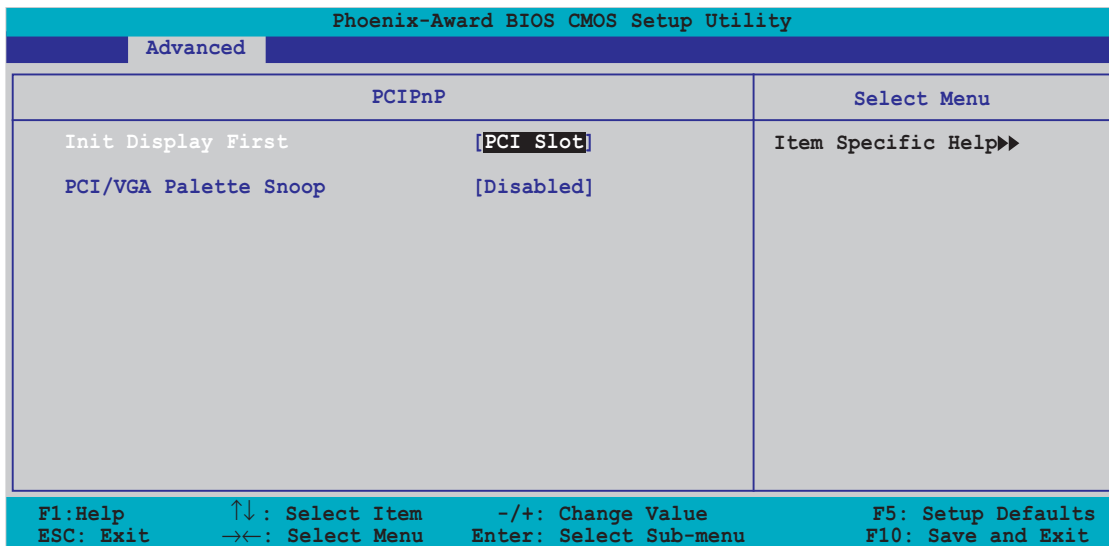

Init Display First [PCI slot]

Allows you to set which graphics controller to use as primary boot device.
Configuration options: [PCI Slot] [PCIEx]

PCI/VGA Palette Snoop [Disabled]

When set to [Enabled], the palette snooping feature informs the PCI devices that an ISA graphics device is installed in the system so that the latter can function correctly. Configuration options: [Disabled] [Enabled]

4.4.4 Onboard Devices Configuration

| Phoenix-Award BIOS CMOS Setup Utility | |
|---------------------------------------------------------------------------------------------------------------------------------------------------------------------------------------------------------------------------------------------------------------------------------------------------------------------------------------------------------------------------------------------------------------------------------------------------------------------------------------------------------------------------------------------------------------------------------------------------------------------------------------|----------------------|
| Advanced | |
| Onboard Device Configuration | Select Menu |
| <ul style="list-style-type: none"> ▶ IDE Function Setup ▶ NVRAID Configuration Onboard NV LAN [Enabled] Onboard NV LAN Boot ROM [Disabled] Onboard Intel LAN [Enabled] Onboard Intel LAN Boot ROM [Disabled] Onboard PCI-E SATAII [Enabled] AC97 Audio [Enabled] PCI IEEE 1394a [Enabled] Serial Port1 Address [3F8/IRQ4] Parallel Port Address [378/IRQ7] Parallel Port Mode [ECP+EPP] ECP Mode Use DMA [3] Game Port Address [201] Midi Port Address [330] Midi Port IRQ [10] | Item Specific Help▶▶ |
| F1: Help ↑↓: Select Item -/+ : Change Value F5: Setup Defaults ESC: Exit →←: Select Menu Enter: Select Sub-menu F10: Save and Exit | |

IDE Function Setup

This sub-menu contains IDE function-related items. Select an item then press <Enter> to edit.

| Phoenix-Award BIOS CMOS Setup Utility | |
|---------------------------------------------------------------------------------------------------------------------------------------------------------------------------------------------------------------------------------------------------------------|----------------------------------------------------------------|
| Advanced | |
| Onboard Device Configuration | Select Menu |
| OnChip IDE Channel0 [Enabled] OnChip IDE Channel1 [Enabled] IDE DMA transfer access [Enabled] Serial Port 1, 2 [Enabled] SATA DMA transfer [Enabled] Serial Port 3, 4 [Enabled] SATA2 DMA transfer [Enabled] IDE Prefetch Mode [Enabled] | Item Specific Help▶▶ Disable/Enable OnChip IDE Channel0 |
| F1: Help ↑↓: Select Item -/+ : Change Value F5: Setup Defaults ESC: Exit →←: Select Menu Enter: Select Sub-menu F10: Save and Exit | |

OnChip IDE Channel0 [Enabled]

Allows you to enable or disable the onchip IDE channel 0 controller .
Configuration options: [Disabled] [Enabled]

OnChip IDE Channel1 [Enabled]

Allows you to enable or disable the onchip IDE channel 1 controller .
Configuration options: [Disabled] [Enabled]

IDE DMA transfer access [Enabled]

Allows you to enable or disable the IDE DMA transfer access.
Configuration options: [Disabled] [Enabled]

Serial Port 1, 2 [Enabled]

Allows you to enable or disable the SATA 1 and 2 ports.
Configuration options: [Disabled] [Enabled]

SATA DMA transfer [Enabled]

Allows you to enable or disable the SATA DMA transfer access.
Configuration options: [Disabled] [Enabled]

Serial Port 3, 4 [Enabled]

Allows you to enable or disable the SATA 3 and 4 ports.
Configuration options: [Disabled] [Enabled]

SATA2 DMA transfer [Enabled]

Allows you to enable or disable the SATA2 DMA transfer access.
Configuration options: [Disabled] [Enabled]

IDE Prefetch Mode [Enabled]

Allows you to enable or disable the IDE prefetch mode.
Configuration options: [Disabled] [Enabled]

NVRAID Configuration

This sub-menu contains NVRAID function-related items. Select an item then press <Enter> to edit.

| Phoenix-Award BIOS CMOS Setup Utility | |
|---------------------------------------|-------------------------------------|
| Advanced | |
| NVRAID Configuration | Select Menu |
| RAID Enabled [Disabled] | Item Specific Help▶▶ |
| x IDE Primary Master RAID Disabled | Disable/Enable NVIDIA RAID feature. |
| x IDE Primary Slave RAID Disabled | |
| x IDE Secondary Master RAID Disabled | |
| x IDE Secondary Slave RAID Disabled | |
| x First SATA Master RAID Disabled | |
| x Second SATA Master RAID Disabled | |
| x Third SATA Master RAID Disabled | |
| x Fourth SATA Master RAID Disabled | |

F1:Help ↑↓: Select Item -/+ : Change Value F5: Setup Defaults
ESC: Exit →←: Select Menu Enter: Select Sub-menu F10: Save and Exit

RAID Enabled [Disabled]

Enables or disables the onboard RAID controller. When Enabled, the succeeding items becomes user-configurable.

Configuration options: [Enabled] [Disabled]

IDE Primary, Secondary Master/Slave RAID [Disabled]

Enables or disables the RAID function of the primary or secondary master or slave IDE. Configuration options: [Enabled] [Disabled]

First, Second, Third, Fourth SATA Master RAID [Disabled]

Enables or disables the RAID function of the first, second, third or fourth SATA master drive. Configuration options: [Enabled] [Disabled]

Onboard NV LAN [Enabled]

Enables or disables the onboard NVIDIA® Gigabit LAN controller.

Configuration options: [Enabled] [Disabled]

OnBoard NV LAN Boot ROM [Disabled]

Allows you to enable or disable the onboard NVIDIA® LAN boot ROM.

Configuration options: [Disabled] [Enabled]

Onboard Intel LAN [Disabled]

Enables or disables the onboard Intel® Gigabit LAN controller.

Configuration options: [Enabled] [Disabled]

OnBoard Intel LAN Boot ROM [Disabled]

Allows you to enable or disable the onboard Intel® boot ROM.
Configuration options: [Disabled] [Enabled]

Onboard PCI-E SATAII [Enabled]

Allows you to enable or disable the onboard PCI Express Serial ATA II controller. Configuration options: [Disabled] [Enabled]

AC97 Audio [Enabled]

Allows you to disable or enabled the onboard AC97 audio controller.
Configuration options: [Disabled] [Enabled]

PCI IEEE 1394a [Enabled]

Allows you to disable or enabled the onboard PCI IEEE 1394 controller.
Configuration options: [Disabled] [Enabled]

Serial Port1 Address [3F8/IRQ4]

Allows you to select the Serial Port1 base address.
Configuration options: [Disabled] [3F8/IRQ4] [3E8/IRQ4] [2E8/IRQ3]

Parallel Port Address [378/IRQ7]

Allows you to select the Parallel Port base addresses.
Configuration options: [Disabled] [378/IRQ7] [278/IRQ5] [3BC/IRQ7]

Parallel Port Mode [ECP+EPP]

Allows you to select the Parallel Port mode.
Configuration options: [Normal] [Bi-directional] [EPP] [ECP]

ECP Mode Use DMA [3]

Allows selection of ECP Mode. Configuration options: [1] [3]

Game Port Address [201]

Allows you to select the Game Port address or to disable the port.
Configuration options: [Disabled] [201] [209]

Midi Port Address [330]

Allows you to select the Game Port address or to disable the port.
Configuration options: [Disabled] [330] [300]

Midi Port IRQ [10]

Allows you to set the Midi port IRQ address. Configuration options: [5] [10]

4.4.5 USB Configuration

The items in this menu allows you to change the USB-related features. Select an item then press <Enter> to display the configuration options.

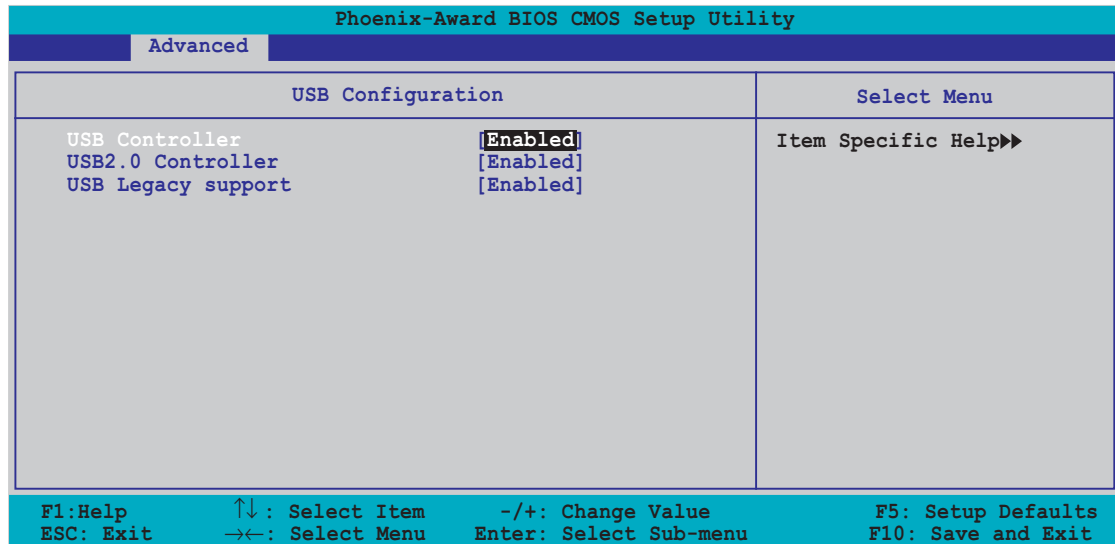

USB Controller [Enabled]

Allows you to enable or disable the onchip USB controller.
Configuration options: [Disabled] [Enabled]

USB 2.0 Controller [Enabled]

Allows you to enable or disable the USB 2.0 controller.
Configuration options: [Disabled] [Enabled]

USB Legacy Support [Enabled]

Allows you to enable or disable support for USB devices on legacy operating systems (OS). Configuration options: [Disabled] [Enabled]

4.4.6 SLI Configuration

| Phoenix-Award BIOS CMOS Setup Utility | | | |
|---------------------------------------|-----------------|-------------------------------------------------------------------------------------------------------------------------------------------------------------------------------------------------------------------------------------|--------------------|
| Advanced | | | |
| SLI Configuration | | Select Menu | |
| SLI mode | [Auto] | Item Specific Help▶▶ | |
| EZ-Plug Warning | [Enabled] | Allows you to select the Scalable Link Interface mode. When set to Auto, BIOS detects the setting of SLI EZ selector card. Set to Normal when using single PCI-E graphics card; set to SLI mode when 2 SLI ready cards are plugged. | |
| F1: Help | ↑↓: Select Item | -/+ : Change Value | F5: Setup Defaults |
| ESC: Exit | →←: Select Menu | Enter: Select Sub-menu | F10: Save and Exit |

SLI Mode [Auto]

Allows you to select the Scalable Link Interface (SLI™) mode. When set to Auto, the BIOS detects the setting of the SLI EZ Selector card. Set to Normal when using one PCI Express graphics card or set to SLI mode when using two SLI-ready graphics cards.

Configuration options: [Auto] [Normal] [SLI]



- We recommend to keep the setting of this item to [Auto].
- When not set to [Auto], make sure that the setting is the same as the ASUS EZ selector card setting.
- See section “6.2.1 Setting the SLI selector card” on page 6-2 for details.

EZ-Plug Warning [Enabled]

Allows you to enable or disable the EZ-Plug warning feature.

Configuration options: [Disabled] [Enabled]

4.4.7 JumperFree Configuration

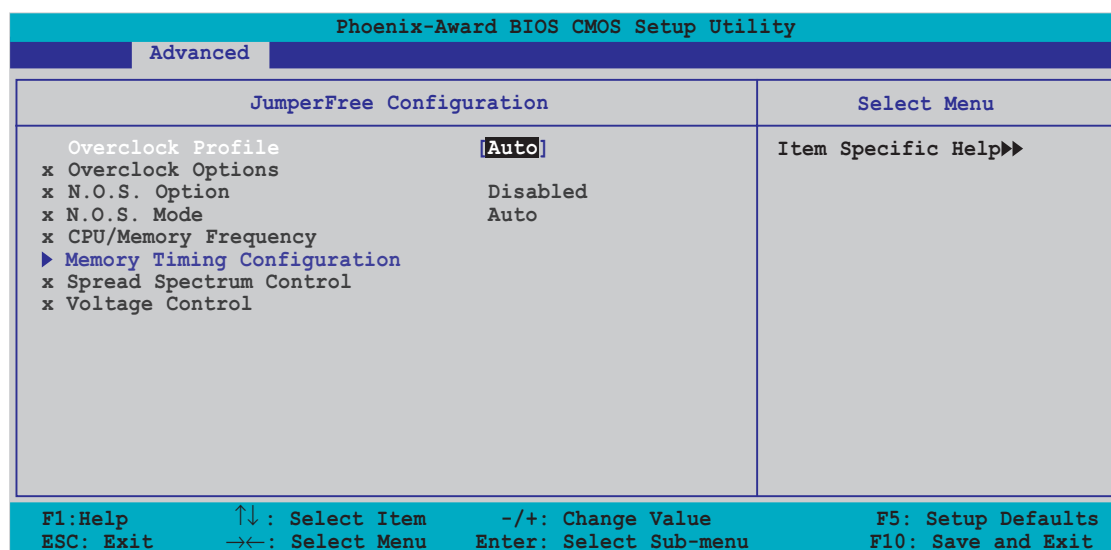

Overclock Profile [Auto]

Allows selection of CPU overclocking options to achieve desired CPU internal frequency. Select either one of the preset overclocking configuration options:

| | |
|---------------------|------------------------------------------------------------------------------------------------------------------------------------------------------------------|
| Manual | Allows you to individually set overclocking parameters. |
| Auto | Loads the optimal settings for the system. |
| Standard | Loads the standard settings for the system. |
| AI Overclock | Loads overclocking profiles with optimal parameters for stability when overclocking. |
| AI N.O.S. | The ASUS AI Non-delay Overclocking System feature intelligently determines the system load and automatically boost the performance for the most demanding tasks. |
| Safe Mode | Loads the safest configuration for your system. |

Overclock Options [Disable]

Allows you to disable or set the overlocking options.

Configuration options: [Disable] [Overclock 5%] [Overclock 10%]
[Overclock 15%] [Overclock 20%] [FSB 960/800] [FSB 1280/800]
[FSB 1000/667] [FSB 1333/667] [FSB 1200/800] [FSB 1600/800]



The Overclock Options item is user-configurable only when the **Overclock Profile** is set to [AI Overclock].

N.O.S. Option [Disabled]

Disables or sets the Non-Delay Overclocking System options.

Configuration options: [Disable] [Overclock 3%] [Overclock 5%]
[Overclock 8%] [Overclock 10%]

N.O.S. Mode [Auto]

Sets the Non-Delay Overclocking System mode. Select either of the following configuration options:

Auto - loads the optimum sensitivity and overclocking percentage setting.

Standard - activates overclocking on a threshold between light and heavy CPU loading.

Sensitive - activates overclocking on a light CPU loading.

Heavy Load - activates overclocking on a heavy CPU loading.



The N.O.S. Option and N.O.S. Mode items are user-configurable only when the **Overclock Profile** is set to [AI N.O.S.].

CPU/Memory Frequency

This sub-menu allows you to set CPU, PCI Express, and memory related fields. Set the **Overclock Profile** to Manual, if you want to configure this item.

| Phoenix-Award BIOS CMOS Setup Utility | | |
|------------------------------------------------------------------------------|-------------|-----------------------------------------------|
| Advanced | | |
| CPU/Memory Configuration | Select Menu | |
| PCIE Frequency (MHz) | [100] | Item Specific Help▶▶ Press [Enter] to Set. |
| FSB Turbo Mode | [Disabled] | |
| System Clock Mode | [Optimal] | |
| x New FSB Speed (QDR) | Auto | |
| Current FSB Speed (QDR) | 800.0 MHz | |
| x New MEM Speed (DDR) | Auto | |
| Current MEM Speed (DDR) | 533.3 MHz | |
| F1: Help ↑↓: Select Item -/+ : Change Value F5: Setup Defaults | | |
| ESC: Exit →←: Select Menu Enter: Select Sub-menu F10: Save and Exit | | |

PCIE Frequency [100]

Allows you to set the PCI Express frequency. Key-in a decimal value between 100-150 MHz. Configuration options: [100MHz] [101MHz] ~ [150MHz]



Selecting a very high PCIE frequency may cause the system to become unstable! If this happens, revert to the default setting.

FSB Turbo Mode [Disabled]

Enables or disables the Front Side Bus (FSB) turbo mode. Configuration options: [Disabled] [Enabled]

System Clock Mode [Optimal]

Sets the system clock mode. The default setting [Optimal], automatically sets the FSB and memory speeds. Set to [Linked] if you want the system to overclock proportionally, setting to [Expert] allows you to manually input the FSB and memory speeds. Configuration options: [Optimal] [Linked] [Expert]

New FSB Speed (QDR) [800]

Allows you to key-in new FSB speed. The configuration options vary depending on the CPU installed.



The New FSB Speed (QDR) item is user-configurable only when the **System Clock Mode** is set to [Linked] or [Expert].

Current FSB Speed (QDR)

Displays the current FSB speed.

New MEM Speed (DDR)

Allows you to key-in new memory speed. The configuration options vary depending on the DDR2 memory installed.



The New MEM Speed (DDR) item is user-configurable only when the **System Clock Mode** is set to [Expert].

Current MEM Speed (DDR)

Displays the current memory speed.

Memory Timing Configuration

This sub-menu allows you to set the memory timing configuration. Set the **Overclock Profile** to Manual, if you want to configure this item.

| Phoenix-Award BIOS CMOS Setup Utility | | |
|---------------------------------------|------------------|----------------------|
| Advanced | | |
| CPU/Memory Configuration | | Select Menu |
| Memory Timings | [Optimal] | Item Specific Help▶▶ |
| Current CAS-RCD-RP-RAS-TC | 4-4-4-12-16 (1T) | |
| x T(CAS) | Auto | |
| x T(RCD) | Auto | |
| x T(RP) | Auto | |
| x T(RAS) | Auto | |
| x T(RC) | Auto | |
| x Addressing Mode | Auto | |

F1: Help ↑↓: Select Item -/+: Change Value F5: Setup Defaults
ESC: Exit →←: Select Menu Enter: Select Sub-menu F10: Save and Exit

Memory Timings [Optimal]

Allows you to set the memory timing parameters. The default setting [Optimal], automatically configures the memory timings. Set to [Expert] if you want to input the memory timings manually.

Current CAS-RCD-RP-RAS-RC

Displays the current CAS, RCD, RP, RAS, and RC memory timing parameter settings.

T (CAS) [Auto]

Controls the latency between the SDRAM read command and the time the data actually becomes available.

Configuration options: [Auto] [1] [2] [3] [4] [5] [6]

T (RCD) [Auto]

Sets the RAS-to-CAS delay timing.

Configuration options: [Auto] [1] [2] [3] [4] [5] [6] [7]

T (RP) [Auto]

Sets the row-precharge delay timing.

Configuration options: [Auto] [1] [2] [3] [4] [5] [6] [7]

T (RAS) [Auto]

Sets the row-active delay timing.

Configuration options: [Auto] [1] [2] ~ [31]

T (RC) [Auto]

Sets the row cycle timing.

Configuration options: [Auto] [1] [2] ~ [31]

Addressing Mode [Auto]

Allows you to enable two-clock addressing.

Configuration options: [Auto] [1 clock] [2 clock]

Spread Spectrum Control

This sub-menu allows you to set the CPU, PCI Express, Serial ATA, and Lightning Data Transport (LDT) clock generator spread spectrum. The spread spectrum is used to dynamically change the system frequency to minimize problems with electromagnetic interference (EMI). Set the **Overclock Profile** to Manual, if you want to configure this item.

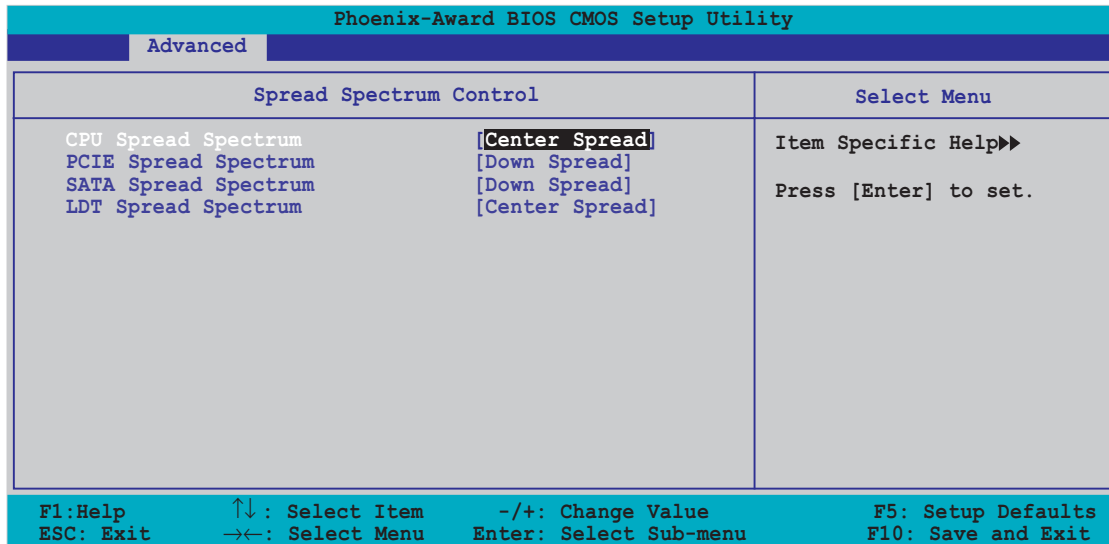

CPU Spread Spectrum [Center Spread]

Disables or sets the CPU clock generator spread spectrum. The default setting [Center Spread] allows a dynamic CPU frequency change of -0.25% to +0.25%. The [Down Spread] setting allows a dynamic CPU frequency change of -0.5% to 0.0%. Setting to [0.5%++ Spread] allows dynamic frequency changes from -0.5% to +0.5%.
Configuration options: [Disabled] [Center Spread] [Down Spread] [0.5%++ Spread]

PCIE Spread Spectrum [Down Spread]

Disables or sets the PCI Express clock generator spread spectrum. The default setting [Down Spread] allows a dynamic PCI Express frequency change of -0.5% to 0.0%.
Configuration options: [Disabled] [Down Spread]

SATA Spread Spectrum [Down Spread]

Disables or sets the Serial ATA clock generator spread spectrum. The default setting [Down Spread] allows a dynamic Serial ATA frequency change of -0.5% to 0.0%.
Configuration options: [Disabled] [Down Spread]

LDT Spread Spectrum [Center Spread]

Disables or sets the Lightning Data Transport (LDT) clock generator spread spectrum. The default setting [Center Spread] allows a dynamic LDT frequency change of -0.25% to +0.25%.

Configuration options: [Disabled] [Center Spread]

Voltage Control

This sub-menu allows you to set the system operating voltages. Set the **Overclock Profile** to Manual, if you want to configure this item.

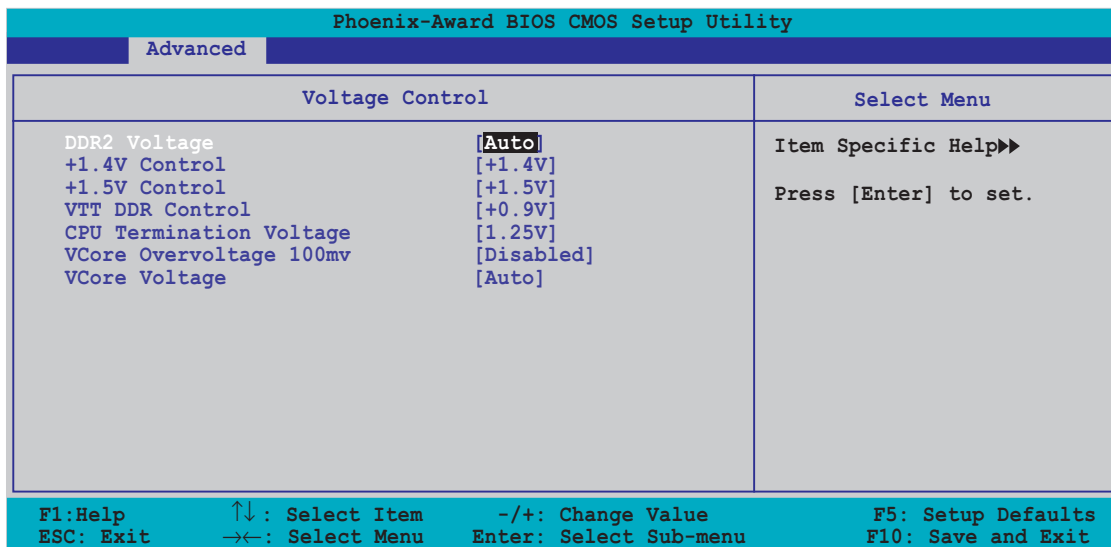

DDR2 Voltage [Auto]

Allows you to set the DDR2 operating voltage. Set to Auto for safe mode. Configuration options: [Auto] [+1.80V] [+1.85V] [+1.90V] [+1.95] [+2.00V] [+2.05V] [+2.10V] [+2.15V]



Refer to the DDR2 documentation before setting the memory voltage. Setting a very high memory voltage may damage the memory module(s)!

+1.4V Control [+1.4V]

Allows you to set the +1.4V control.
Configuration options: [+1.4V] [+1.5V]

+1.5V Control [+1.5V]

Allows you to set the +1.5V control.
Configuration options: [+1.5V] [+1.6V]

VTT DDR Control [+0.9V]

Allows you to set the VTT DDR control.
Configuration options: [+0.9V] [+1.0V]

CPU Termination Voltage [1.25V]

Allows you to set the CPU termination voltage.
Configuration options: [1.25V] [1.30V] [1.35V] [1.40V]

VCore Overvoltage 100mv [Disabled]

Disables or enables the VCore overvoltage 100mv feature.
Configuration options: [Disabled] [Enabled]

VCore Overvoltage 100mv [Disabled]

Disables or enables the VCore overvoltage 100mv feature.
Configuration options: [Disabled] [Enabled]

VCore Voltage [Auto]

Sets the operating VCore voltage. Configuration options: [Auto]
[1.6000V] [1.5875V] [1.5750V] [1.5625V] [1.5500V] [1.5375V]
[1.5250V] [1.5125V] [1.5000V] [1.4875V] [1.4750V] [1.4625V]
[1.4500V] [1.4375V] [1.4250V] [1.4125V] [1.4000V] [1.3875V]
[1.3750V] [1.3625V] [1.3500V] [1.3375V] [1.3250V] [1.3125V]
[1.3000V] [1.2875V] [1.2750V] [1.2625V] [1.2500V] [1.2375V]
[1.2250V] [1.2125V] [1.2000V] [1.1875V] [1.1750V] [1.1625V]
[1.1500V] [1.1375V] [1.1250V] [1.1125V] [1.1000V] [1.0875V]
[1.0750V] [1.0625V] [1.0500V] [1.0375V] [1.0250V] [1.0125V]
[1.0000V] [0.9875V] [0.9750V] [0.9625V] [0.9500V] [0.9375V]
[0.9250V] [0.9125V] [0.9000V] [0.8875V] [0.8750V] [0.8625V]
[0.8500V] [0.8375V]

4.4.8 LAN Cable Status

The items in this menu displays the status of the Local Area Network (LAN) cable.

| Phoenix-Award BIOS CMOS Setup Utility | | | |
|---------------------------------------|-----------------|------------------------------|--------------------|
| Advanced | | | |
| JumperFree Configuration | | Select Menu | |
| AI NET2 | [Disabled] | | |
| Pair | Status | Length | |
| LAN1 (1-2) | Open | N/A | |
| LAN1 (3-4) | Open | N/A | |
| LAN1 (5-6) | Open | N/A | |
| LAN1 (7-8) | Open | N/A | |
| | | Item Specific Help▶▶ | |
| | | Check LAN cable during POST. | |
| F1:Help | ↑↓: Select Item | -/+ : Change Value | F5: Setup Defaults |
| ESC: Exit | →←: Select Menu | Enter: Select Sub-menu | F10: Save and Exit |

AI NET2 [Disabled]

Enables or disables AI NET2 feature.

Configuration options: [Disabled] [Enabled]

4.4.9 PEG Link Mode

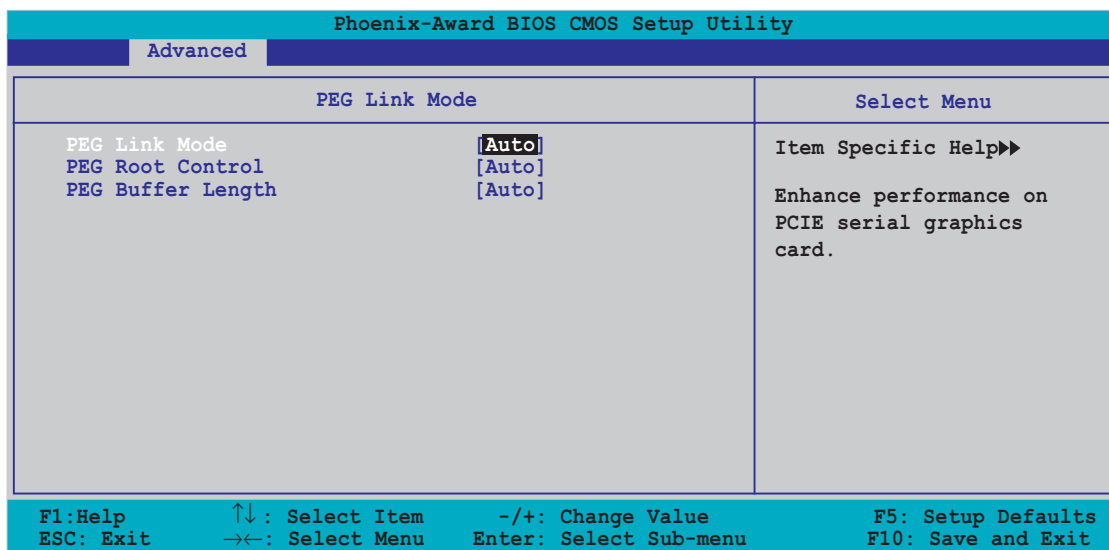

PEG Link Mode [Disabled]

Sets the PCI Express graphics link mode. Setting this item to [Auto] allows the motherboard to automatically adjust the PCI Express graphics link mode to the correct frequency based on the system configuration. Four additional settings are available for overclocking the PEG Link Mode. Configuration options: [Auto] [Slow] [Normal] [Fast] [Faster]



Setting to [Fastest] may cause your system to be unstable. If this happens, revert to [Auto].

PEG Root Control [Auto]

Allows you to enable or disable the PCI Express graphics root control. Configuration options: [Auto] [Enabled] [Disabled]

PEG Buffer Length [Auto]

Allows you to set the PCI Express graphics buffer length. For optimum performance, set this item to Auto. Configuration options: [Auto] [Long] [Short]

4.4.10 Speech Configuration

| Phoenix-Award BIOS CMOS Setup Utility | |
|-----------------------------------------|-------------------------------------|
| Advanced | |
| Speech Configuration | Select Menu |
| Speech IC Reporter [Enabled] | Item Specific Help▶▶ |
| Report IDE Error [Disabled] | Enable/Disable Speech IC Controller |
| Report System Booting [Disabled] | |

F1: Help ↑↓: Select Item -/+ : Change Value F5: Setup Defaults
ESC: Exit →←: Select Menu Enter: Select Sub-menu F10: Save and Exit

Speech IC Reporter **[Enabled]**

Allows you to enable or disable the ASUS Speech POST Reporter™ feature.
Configuration options: [Disabled] [Enabled]



The following items appear only when Speech POST Reporter is set to Enabled.

Report IDE Error **[Disabled]**

Enables or disables the report feature in the event of an IDE error.
Configuration options: [Disabled] [Enabled]

Report System Booting **[Disabled]**

Enables or disables the report after booting the system.
Configuration options: [Disabled] [Enabled]

4.5 Power menu

The Power menu items allow you to change the settings for the Advanced Configuration and Power Interface (ACPI) and the Advanced Power Management (APM). Select an item then press <Enter> to display the configuration options.

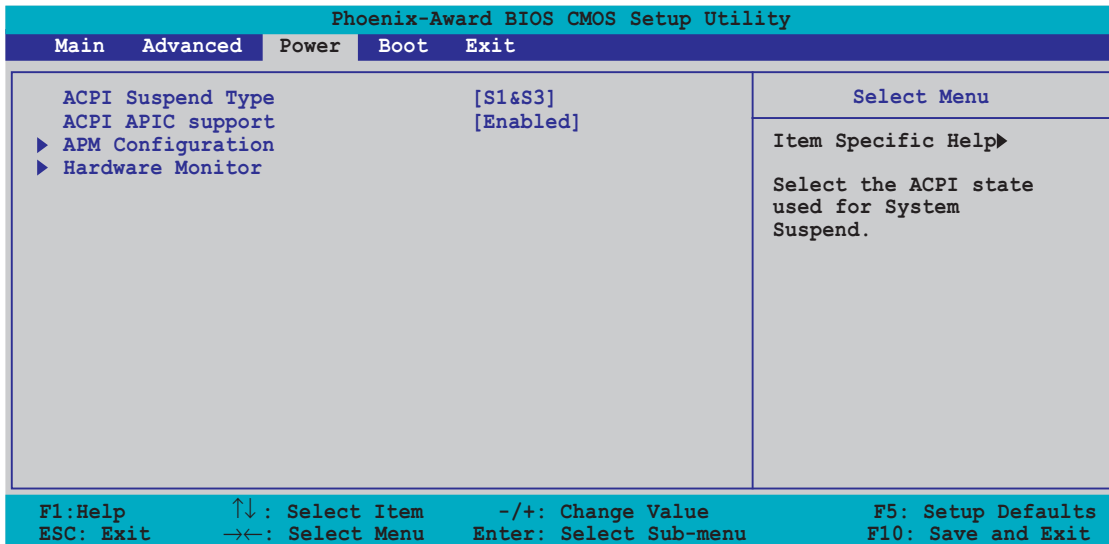

4.5.1 ACPI Suspend Type [S1&S3]

Allows you to select the Advanced Configuration and Power Interface (ACPI) state to be used for system suspend.

Configuration options: [S1 (POS)] [S3(STR)] [S1&S3]

4.5.2 ACPI APIC Support [Enabled]

Allows you to enable or disable the Advanced Configuration and Power Interface (ACPI) support in the Application-Specific Integrated Circuit (ASIC). When set to Enabled, the ACPI APIC table pointer is included in the RSDT pointer list. Configuration options: [Disabled] [Enabled]

4.5.3 APM Configuration

| Phoenix-Award BIOS CMOS Setup Utility | | |
|---------------------------------------|---------------|---------------------------------------------------------------------------------------------------------------|
| Power | | |
| APM Configuration | Select Menu | |
| Restore on AC Power Loss | [Disabled] | Item Specific Help▶▶ Press [ENTER] to select whether or not to restart the system after AC power loss. |
| HDD Down In Suspend | [Disabled] | |
| PWR Button < 4 secs | [Instant Off] | |
| Power On By PCI Devices | [Disabled] | |
| Power On By External Modems | [Disabled] | |
| Power-On by RTC Alarm | [Disabled] | |
| x Date (of Month) | 0 | |
| x Resume Time (hh:mm:ss) | 0 : 0 : 0 | |
| Power Up By PS/2 Mouse | [Disabled] | |
| Power Up By PS/2 Keyboard | [Disabled] | |

F1: Help ↑↓: Select Item -/+ : Change Value F5: Setup Defaults
ESC: Exit →←: Select Menu Enter: Select Sub-menu F10: Save and Exit

Restore on AC Power Loss [Disabled]

Allows you to enable or disable the Restore on AC Power Loss function.
Configuration options: [Disabled] [Enabled]

HDD Down In Suspend [Disabled]

Allows you to enable or disable the HDD Down In Suspend feature.
Configuration options: [Disabled] [Enabled]

PWR Button < 4 secs [Instant-Off]

Allows you to set the event after the power button is pressed for more than 4 seconds. Configuration options: [Suspend] [Instant-Off]

Power On By PCI Devices [Disabled]

When set to [Enabled], this parameter allows you to turn on the system through a PCI LAN or modem card. This feature requires an ATX power supply that provides at least 1A on the +5VSB lead.
Configuration options: [Disabled] [Enabled]

Power On By External Modems [Disabled]

This allows either settings of [Enabled] or [Disabled] for powering up the computer when the external modem receives a call while the computer is in Soft-off mode. Configuration options: [Disabled] [Enabled]



The computer cannot receive or transmit data until the computer and applications are fully running. Thus, connection cannot be made on the first try. Turning an external modem off and then back on while the computer is off causes an initialization string that turns the system power on.

Power On By RTC Alarm [Disabled]

Allows you to enable or disable RTC to generate a wake event. When this item is set to Enabled, the items Date of Month Alarm and Time (hh:mm:ss) Alarm items become user-configurable with set values.

Configuration options: [Disabled] [Enabled]

Day of Month Alarm [Disabled]

To set the date of alarm, highlight this item and press <Enter> to display the Day of Month Alarm pop-up menu. Key-in a value within the specified range then press <Enter>. Configuration options: [Min=0] [Max=31]

Time (hh:mm:ss) Alarm [Disabled]

To set the time of alarm:

1. Highlight this item and press <Enter> to display a pop-up menu for the hour field.
2. Key-in a value (Min=0, Max=23), then press <Enter>.
3. Press <TAB> to move to the minutes field then press <Enter>.
4. Key-in a minute value (Min=0, Max=59), then press <Enter>.
5. Press <TAB> to move to the seconds field then press <Enter>.
6. Key-in a value (Min=0, Max=59), then press <Enter>.

Power Up By PS/2 Mouse [Disabled]

When set to [Enabled], this parameter allows you to use the PS/2 mouse to turn on the system. This feature requires an ATX power supply that provides at least 1A on the +5VSB lead.

Configuration options: [Disabled] [Enabled]

Power On By PS/2 Keyboard [Disabled]

Allows you to disable the Power On by PS/2 keyboard function or set specific keys on the PS/2 keyboard to turn on the system. This feature requires an ATX power supply that provides at least 1A on the +5VSB lead.

Configuration options: [Disabled] [Space Bar] [Ctrl-ESC] [Power Key]

4.5.4 Hardware Monitor

The items in this sub-menu displays the hardware monitor values automatically detected by the BIOS. It also allows you to change CPU Q-Fan feature-related parameters. Select an item then press <Enter> to display the configuration options.

| Phoenix-Award BIOS CMOS Setup Utility | | |
|---------------------------------------|-------------------|----------------------|
| Power | | |
| Hardware Monitor | | Select Menu |
| Q-Fan Controller | [Disabled] | Item Specific Help▶▶ |
| Vcore Voltage | 1.50V | |
| 3.3V Voltage | 3.31V | |
| 5V Voltage | 4.94V | |
| 12V Voltage | 11.26V | |
| CPU Temperature | 48°C | |
| M/B Temperature | 38°C | |
| CPU FAN Speed | 4962 RPM | |
| PWR FAN Speed | 0 RPM | |
| CHA FAN Speed | 0 RPM | |
| CPU Fan Speed warning | [1200 RPM] | |

F1:Help ↑↓: Select Item -/+ : Change Value F5: Setup Defaults
ESC: Exit →←: Select Menu Enter: Select Sub-menu F10: Save and Exit

Q-Fan Controller [Disabled]

Allows you to enable or disable the ASUS Q-Fan2 feature.
Configuration options: [Disabled] [Enabled]

VCORE Voltage, +12V Voltage, 3.3V Voltage, 5VCC Voltage

The onboard hardware monitor automatically detects the voltage output through the onboard voltage regulators. These items are not user-configurable.

CPU Temperature, M/B Temperature

The onboard hardware monitor automatically detects and displays the motherboard and CPU temperatures. These items are not user-configurable.

CPU Fan Speed, PWR Fan Speed, CHA Fan Speed

The onboard hardware monitor automatically detects and displays the CPU, Power, and Chassis fan speeds in rotations per minute (RPM). If the fan is not connected to the motherboard, the field shows 0. These items are not user-configurable.

CPU Fan Speed warning [1200 RPM]

Allows you to set the CPU fan warning speed.
Configuration options: [Disabled] [800 RPM] [1200 RPM] [1600 RPM]

4.6 Boot menu

The Boot menu items allow you to change the system boot options. Select an item then press <Enter> to display the sub-menu.

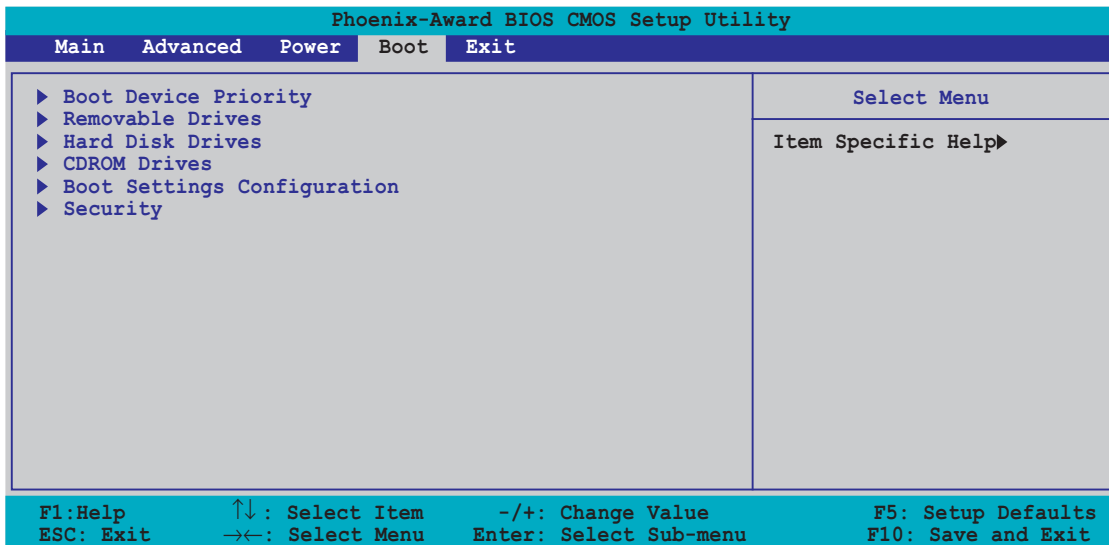

4.6.1 Boot Device Priority

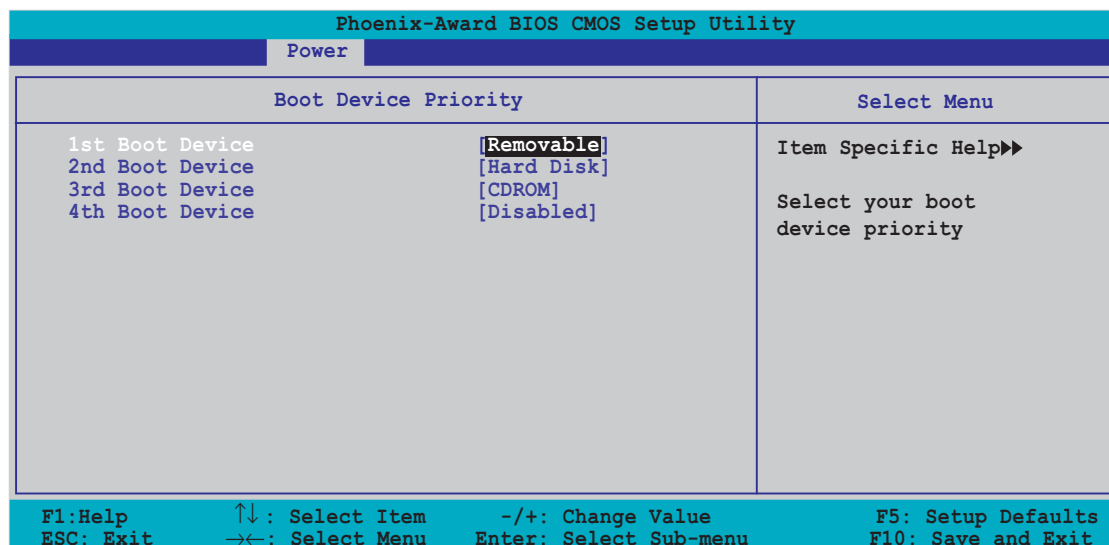

1st ~ xxth Boot Device [Removable]

These items specify the boot device priority sequence from the available devices. The number of device items that appears on the screen depends on the number of devices installed in the system.

Configuration options: [Removable] [Hard Disk] [CDROM] [Legacy LAN] [Disabled]

4.6.2 Removable Drives

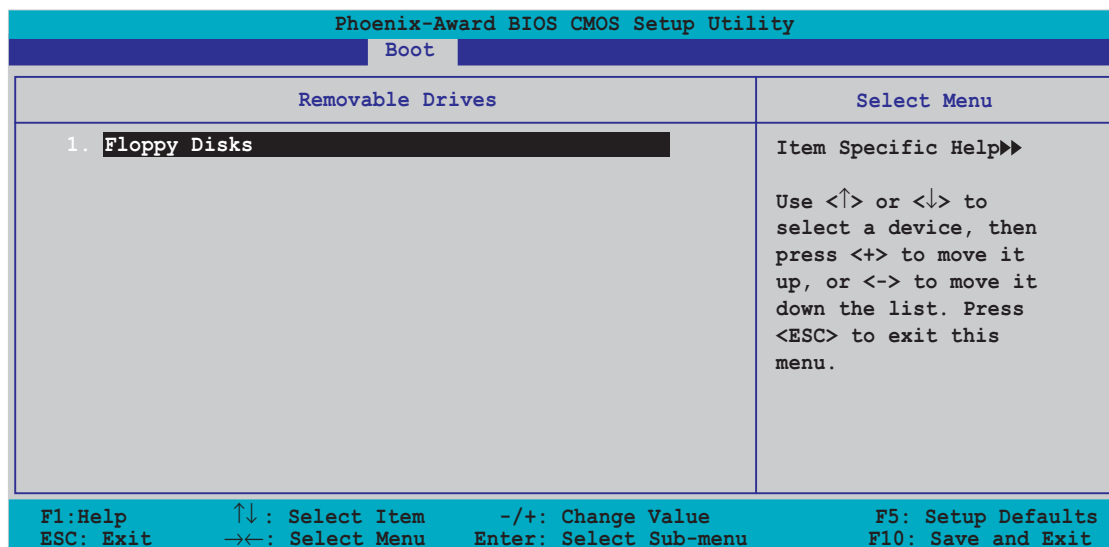

1. Floppy Disks

Allows you to assign a removable drive attached to the system.

4.6.3 Hard Disk Drives

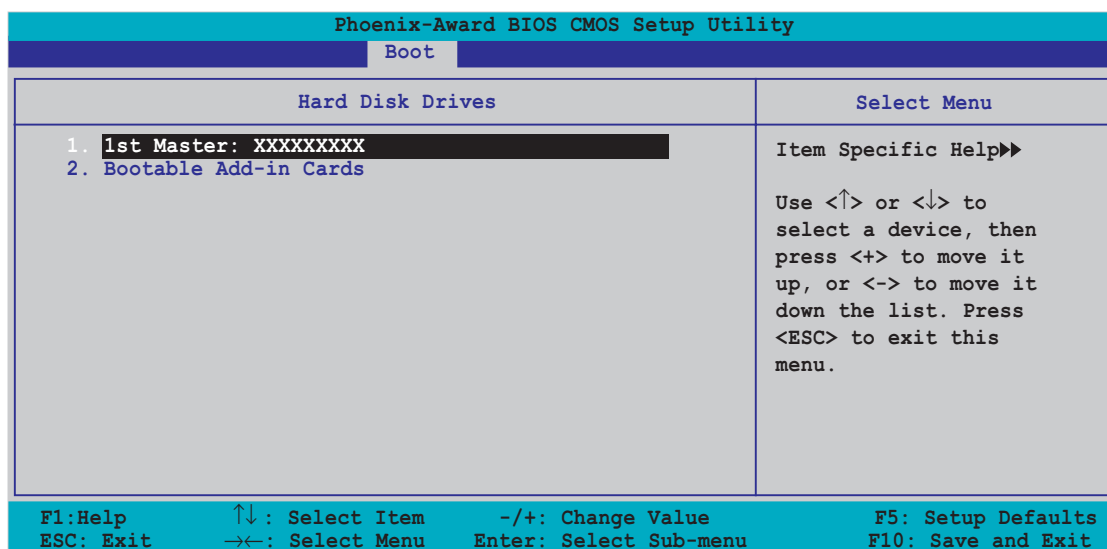

1. 1st Master: XXXXXXXXX

Allows you to assign hard disk drives attached to the system.

4.6.4 CDROM Drives

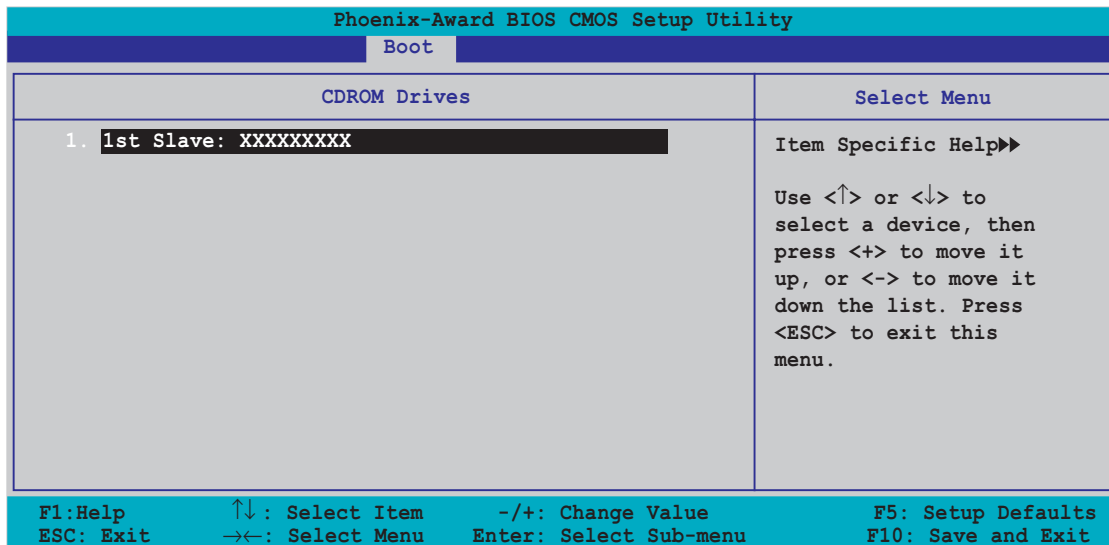

1. 1st Slave: XXXXXXXXX

Allows you to assign optical drives attached to the system.

4.6.5 Boot Settings Configuration

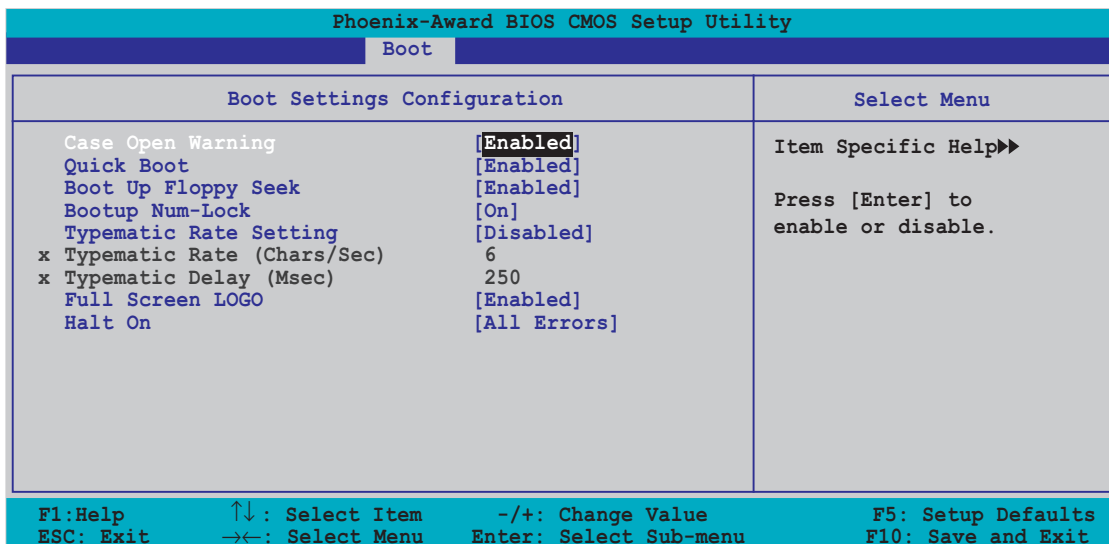

Case Open Warning [Enabled]

Enables or disables the chassis open status feature. Setting to Enabled, clears the chassis open status. Refer to section "2.7 Internal connectors" for setting details. Configuration options: [Disabled] [Enabled]

Quick Boot [Enabled]

Allows you to enable or disable the system quick boot feature. When Enabled, the system skips certain tests while booting. Configuration options: [Disabled] [Enabled]

Boot Up Floppy Seek [Enabled]

Enables or disables the chassis open status feature. Setting to Enabled, clears the chassis open status. Configuration options: [Disabled] [Enabled]

Bootup Num-Lock [On]

Allows you to select the power-on state for the NumLock. Configuration options: [Off] [On]

Typematic Rate Setting [Disabled]

Allows you to set the keystroke rate. Enable this item to configure the **Typematic Rate (Chars/Sec)** and the **Typematic Delay (Msec)**. Configuration options: [Disabled] [Enabled]



The items **Typematic Rate (Chars/Sec)** and **Typematic Delay (Msec)** becomes user-configurable only when the item Typematic Rate Setting is enabled.

Typematic Rate (Chars/Sec) [6]

Allows you to select the rate at which a character repeats when you hold a key. Configuration options: [6] [8] [10] [12] [15] [20] [24] [30]

Typematic Delay (Msec) [250]

Allows you to set the delay before keystrokes begin to repeat. Configuration options: [250] [500] [750] [1000]

Full Screen LOGO [Enabled]

Allows you to enable or disable the full screen logo display feature. Configuration options: [Disabled] [Enabled]



-
- Make sure that the above item is set to [Enabled] if you want to use the ASUS MyLogo2™ feature.
 - See section “5.4.1 ASUS MyLogo2™” for details.
-

Halt On [All Errors]

Allows you to error report type. Configuration options: [All Errors] [No Errors] [All, But Keyboard] [All, But Diskette] [All, But Disk/Key]

4.6.6 Security

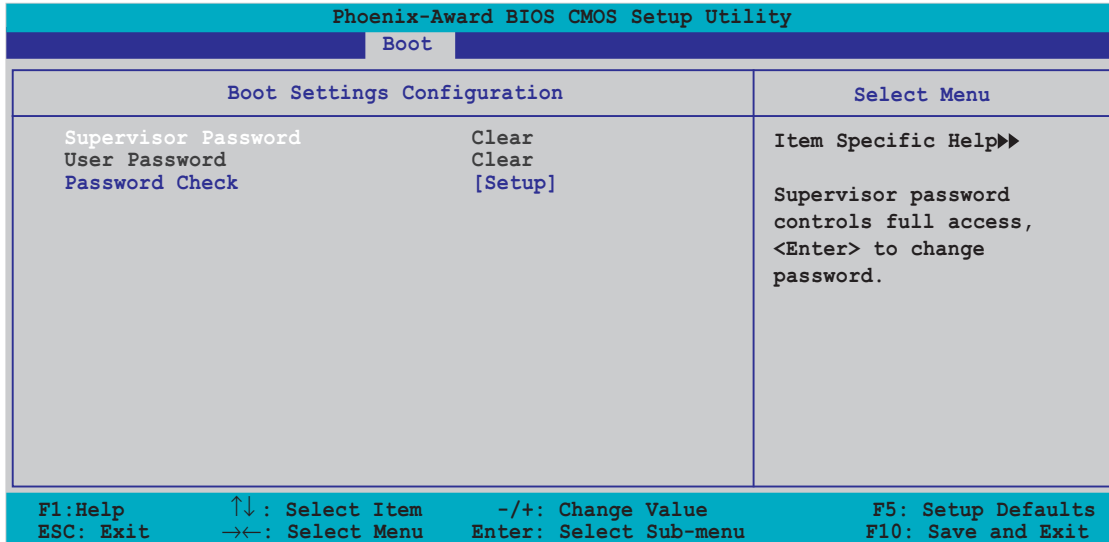

Supervisor Password User Password

These fields allow you to set passwords:

To set a password:

1. Select an item then press <Enter>.
2. Type in a password using a combination of a maximum of eight (8) alpha-numeric characters, then press <Enter>.
3. When prompted, confirm the password by typing the exact characters again, then press <Enter>. The password field setting is changed to Set.

To clear the password:

1. Select the password field and press <Enter> twice. The following message appears:



2. Press any key to continue. The password field setting is changed to Clear.

A note about passwords

The Supervisor password is required to enter the BIOS Setup program preventing unauthorized access. The User password is required to boot the system preventing unauthorized use.

Forgot your password?

If you forget your password, you can clear it by erasing the CMOS Real Time Clock (RTC) RAM. The RAM data containing the password information is powered by the onboard button cell battery. If you need to erase the CMOS RAM, refer to section “2.6 Jumpers” for instructions.

Password Check

This field requires you to enter the password before entering the BIOS setup or the system. Select [Setup] to require the password before entering the BIOS Setup. Select [System] to require the password before entering the system. Configuration options: [Setup] [System]

4.7 Exit menu

The Exit menu items allow you to load the optimal or failsafe default values for the BIOS items, and save or discard your changes to the BIOS items.

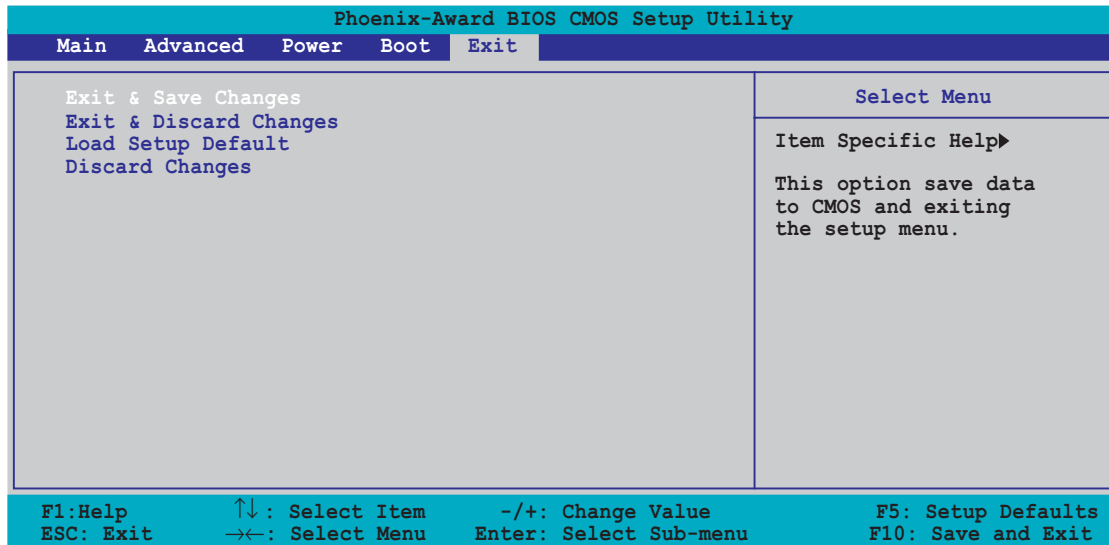

Pressing <Esc> does not immediately exit this menu. Select one of the options from this menu or <F10> from the legend bar to exit.

Exit & Save Changes

Once you are finished making your selections, choose this option from the Exit menu to ensure the values you selected are saved to the CMOS RAM. An onboard backup battery sustains the CMOS RAM so it stays on even when the PC is turned off. When you select this option, a confirmation window appears. Select **Yes** to save changes and exit.



If you attempt to exit the Setup program without saving your changes, the program prompts you with a message asking if you want to save your changes before exiting. Press <Enter> to save the changes while exiting.

Exit & Discard Changes

Select this option only if you do not want to save the changes that you made to the Setup program. If you made changes to fields other than System Date, System Time, and Password, the BIOS asks for a confirmation before exiting.

Load Setup Defaults

This option allows you to load the default values for each of the parameters on the Setup menus. When you select this option or if you press <F5>, a confirmation window appears. Select **Yes** to load default values. Select **Exit & Save Changes** or make other changes before saving the values to the non-volatile RAM.

Discard Changes

This option allows you to discard the selections you made and restore the previously saved values. After selecting this option, a confirmation appears. Select **Yes** to discard any changes and load the previously saved values.

This chapter describes the contents of the support CD that comes with the motherboard package.

5 Software support

| | | |
|-----|--------------------------------------|------|
| 5.1 | Installing an operating system | 5-1 |
| 5.2 | Support CD information | 5-1 |
| 5.3 | Software information | 5-9 |
| 5.4 | RAID configurations | 5-21 |
| 5.5 | Creating a RAID driver disk | 5-37 |

5.1 Installing an operating system

This motherboard supports Windows® 2000/XP operating systems (OS). Always install the latest OS version and corresponding updates to maximize the features of your hardware.



- Motherboard settings and hardware options vary. Use the setup procedures presented in this chapter for reference only. Refer to your OS documentation for detailed information.
- Make sure that you install Windows® 2000 Service Pack 4 or the Windows® XP Service Pack 2 or later versions before installing the drivers for better compatibility and system stability.

5.2 Support CD information

The support CD that came with the motherboard package contains the drivers, software applications, and utilities that you can install to avail all motherboard features.



The contents of the support CD are subject to change at any time without notice. Visit the ASUS website(www.asus.com) for updates.

5.2.1 Running the support CD

Place the support CD to the optical drive. The CD automatically displays the **Drivers** menu if Autorun is enabled in your computer.

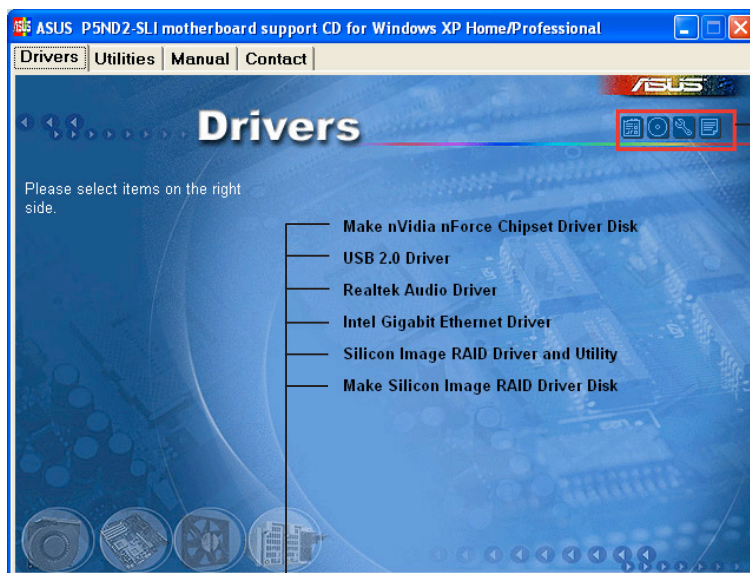

Click an icon to display support CD/motherboard information

Click an item to install



If **Autorun** is NOT enabled in your computer, browse the contents of the support CD to locate the file **ASSETUP.EXE** from the BIN folder. Double-click the **ASSETUP.EXE** to run the CD.

5.2.2 Drivers menu

The drivers menu shows the available device drivers if the system detects installed devices. Install the necessary drivers to activate the devices.

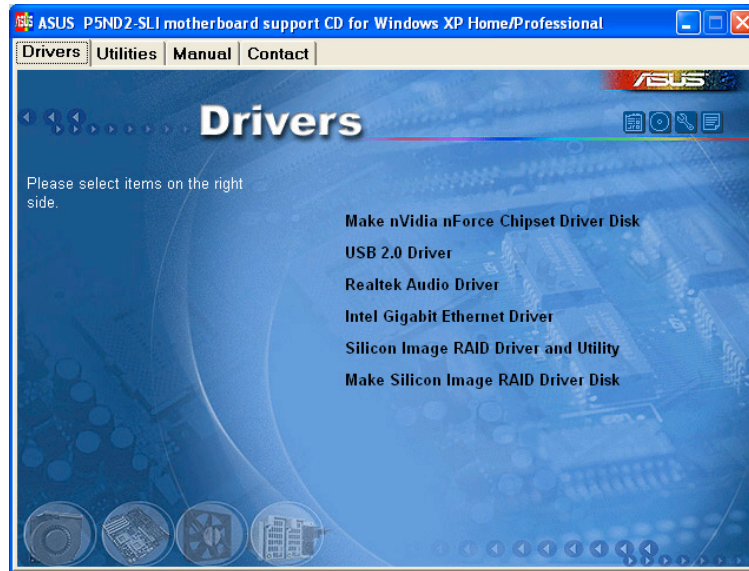

Nvidia Chipset Driver Program

Installs the NVIDIA® Chipset drivers for the NVIDIA® nForce™ 4 SLI chipset.

Make NVIDIA nForce Chipset Driver Disk

Creates the NVIDIA® driver disk for Serial ATA and RAID features.

USB 2.0 Driver

Installs the Universal Serial Bus 2.0 (USB 2.0) driver.

Realtek Audio Driver

Installs the Realtek® ALC850 audio controller and application.

Intel Gigabit Ethernet Driver

Installs the Intel® Gigabit Ethernet driver.

Silicon Image RAID Driver and Utility

Displays the README file of the Silicon Image SATA Link™ Sil 3114 driver installation.

Make Silicon Image RAID Driver Disk

Creates the Silicon Image SATA Link™ Sil 3114 driver disk for Serial ATA RAID.

5.2.3 Utilities menu

The Utilities menu shows the applications and other software that the motherboard supports.

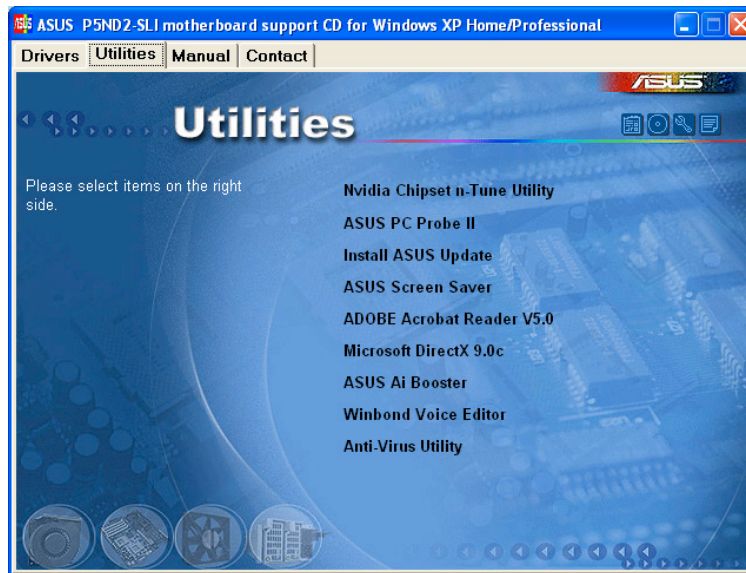

NVIDIA Chipset nTune Utility

Installs the NVIDIA® nTune™ utility that allows easy and safe system tuning for optimum performance.

ASUS PC Probe II

This smart utility monitors the fan speed, CPU temperature, and system voltages, and alerts you of any detected problems. This utility helps you keep your computer in healthy operating condition.

ASUS Update

Allows you to download the latest version of the BIOS from the ASUS website.



Before using the ASUS Update, make sure that you have an Internet connection so you can connect to the ASUS website.

ASUS Screen Saver

Bring life to your computer screen by installing the ASUS screen saver.

ADOBE Acrobat Reader

Installs the Adobe® Acrobat® Reader that allows you to open, view, and print documents in Portable Document Format (PDF).

Microsoft DirectX

Installs the Microsoft® DirectX 9.0 driver. The Microsoft DirectX® 9.0 is a multimedia technology that enhances computer graphics and sound. DirectX® improves the multimedia features of your computer so you can enjoy watching TV and movies, capturing videos, or playing games in your computer. Visit the Microsoft website (www.microsoft.com) for updates.

ASUS AI Booster

The ASUS AI Booster application allows you to overclock the CPU speed in a Windows® environment.

Winbond Voice Editor

This program is for recording and customizing wave files for the ASUS POST Reporter™. Use this program to change the default vocal POST messages. See section “3.2 Vocal POST Messages” for a list of the default messages.

Anti-virus Utility

The anti-virus application scans, identifies, and removes computer viruses. View the online help for detailed information.

5.2.4 Manuals menu

The Manuals menu contains a list of supplementary user manuals. Click an item to open the folder of the user manual.



- Most user manual files are in Portable Document Format (PDF). Install the Adobe® Acrobat® Reader from the **Utilities menu** before opening a user manual file.
- Some user manuals listed in this menu may not be applicable for this motherboard model.

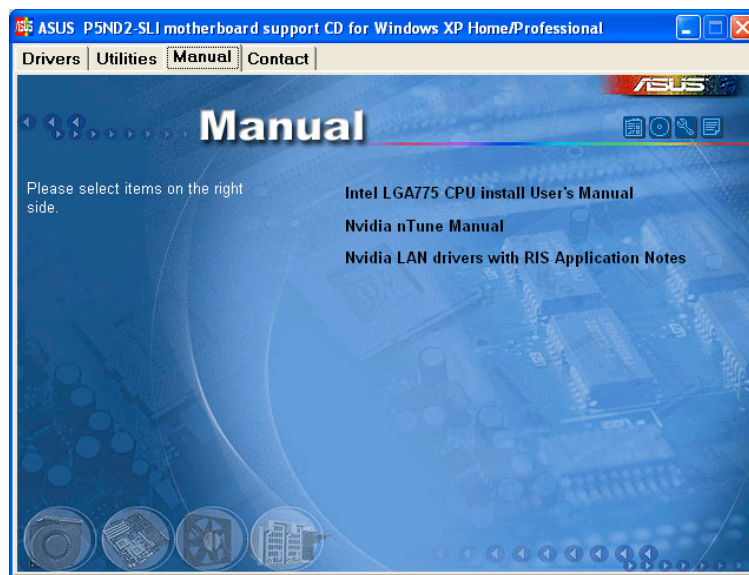

Intel LGA775 CPU Install User's Manual

Allows you to open the Intel® LGA775 CPU installation guide.

NVIDIA nTune Manual

Allows you to open the NVIDIA® nTune™ user's manual.

NVIDIA LAN drivers with RIS Application Notes

Allows you to open the NVIDIA® LAN drivers user manual with RIS application notes.

5.2.5 ASUS Contact information

Click the **Contact** tab to display the ASUS contact information. You can also find this information on the inside front cover of this user guide.

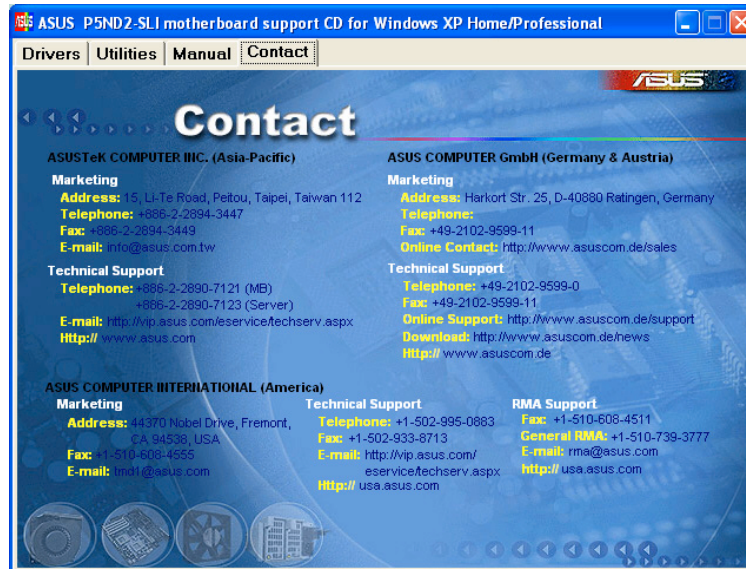

5.2.6 Other information

The icons on the top right corner of the screen give additional information on the motherboard and the contents of the support CD. Click an icon to display the specified information.

Motherboard Info

Displays the general specifications of the motherboard.

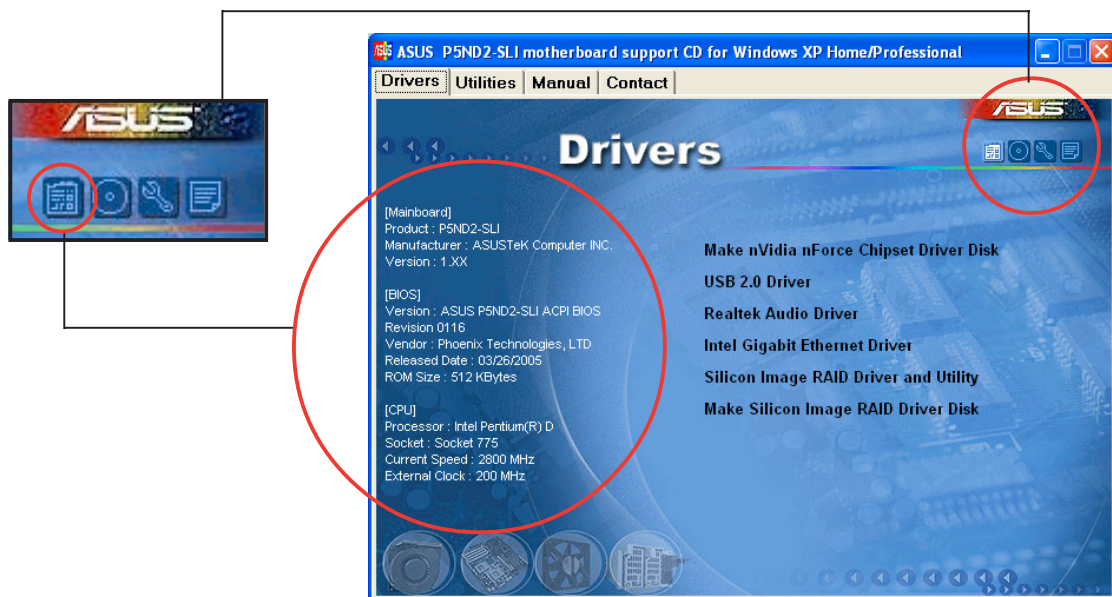

Browse this CD

Displays the support CD contents in graphical format.

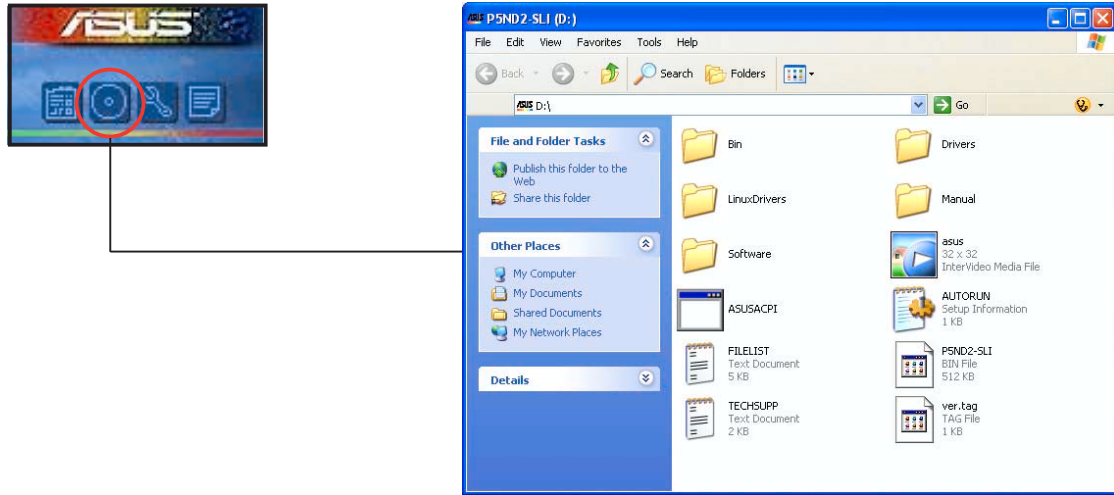

Technical support Form

Displays the ASUS Technical Support Request Form that you have to fill out when requesting technical support.

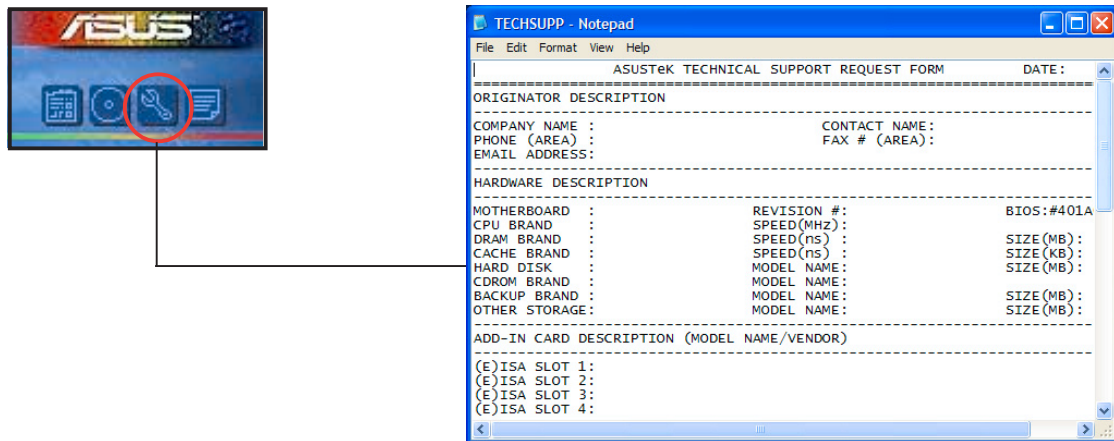

Filelist

Displays the contents of the support CD and a brief description of each in text format.



```
Filelist Notepad
File Edit Format View Help
File list for the included support software for P5N62 Series motherboard
-----
File Name      Description
-----
--Drivers
-Audio
-ALC890        -Realtek AC'97 driver v5.10.00.5831 for windows 2000/XP/2003 and windows 64bit XP/200
-Chipset
-WINXP_2K     -Nvidia chipset driver version v7.03 for windows 2000/XP
-SB01         -Nvidia chipset driver version v6.34 for 64bit windows XP/2003.
-LAN
-Intel        -Intel(R) Ethernet driver v8.4.21.0 for windows 2000/XP/2003/XP.
-SATA
-SII1132     -Silicon Image Serial ATA RAID3 GUI v1.2.2.0 for windows XP/2K/2003.
-RAID_driver -Silicon Image SII 3132 SATA RAID driver v1.2.2.0 for windows XP/2K/2003.
-Manual      -user guide.pdf file.
--Software
-Acrobat     -Adobe Acrobat Reader v5.0.
-AIBooster   -ASUS AI booster utility v2.00.53 for windows 2000/XP/2003 and for windows 64bit XP/20
-AMDFLASH    -Flash bios tool under DOS.
-ASUSupdt   -ASUS update v6.03.01 Install Program for windows 2000/XP/2003 and for windows 64bit X
-Setup.exe
```

5.3 Software information

Most of the applications in the support CD have wizards that will conveniently guide you through the installation. View the online help or readme file that came with the software application for more information.

5.3.1 ASUS MyLogo2™

The ASUS MyLogo2™ utility lets you customize the boot logo. The boot logo is the image that appears on screen during the Power-On Self-Tests (POST). The ASUS MyLogo2™ is automatically installed when you install the **ASUS Update** utility from the support CD. See section “5.2.3 Utilities menu” for details.



- Before using the ASUS MyLogo2™, use the Award BIOS Flash utility to make a copy of your original BIOS file, or obtain the latest BIOS version from the ASUS website. See section “4.1.2 Updating the BIOS”.
- Make sure that the BIOS item **Full Screen Logo** is set to [Enabled] if you wish to use ASUS MyLogo2. See section “4.6.5 Boot Settings Configuration”.
- You can create your own boot logo image in GIF, JPG, or BMP file formats.

To launch the ASUS MyLogo2™:

1. Launch the ASUS Update utility. Refer to section “4.1.5 ASUS Update utility” for details.
2. Select **Options** from the drop down menu, then click **Next**.
3. Check the option **Launch MyLogo to replace system boot logo before flashing BIOS**, then click **Next**.
4. Select **Update BIOS from a file** from the drop down menu, then click **Next**.
5. When prompted, locate the new BIOS file, then click **Next**. The ASUS MyLogo2 window appears.
6. From the left window pane, select the folder that contains the image you intend to use as your boot logo.



7. When the logo images appear on the right window pane, select an image to enlarge by clicking on it.



8. Adjust the boot image to your desired size by selecting a value on the **Ratio** box.



9. When the screen returns to the ASUS Update utility, flash the original BIOS to load the new boot logo.
10. After flashing the BIOS, restart the computer to display the new boot logo during POST.

5.3.2 AI NET 2

The Marvell® Virtual Cable Tester™ (VCT) is a cable diagnostic utility that reports LAN cable faults and shorts using the Time Domain Reflectometry (TDR) technology. The VCT detects and reports open and shorted cables, impedance mismatches, pair swaps, pair polarity problems, and pair skew problems of up to 100 meters at one meter accuracy.

The VCT feature reduces networking and support costs through a highly manageable and controlled network system. This utility can be incorporated in the network systems software for ideal field support as well as development diagnostics.

Using the Virtual Cable Tester™

To use the the Marvell® Virtual Cable Tester™ utility:

1. Launch the VCT utility from the Windows® desktop by clicking **Start > All Programs > Marvell > Virtual Cable Tester**.
2. Click **Virtual Cable Tester** from the menu to display the screen below.

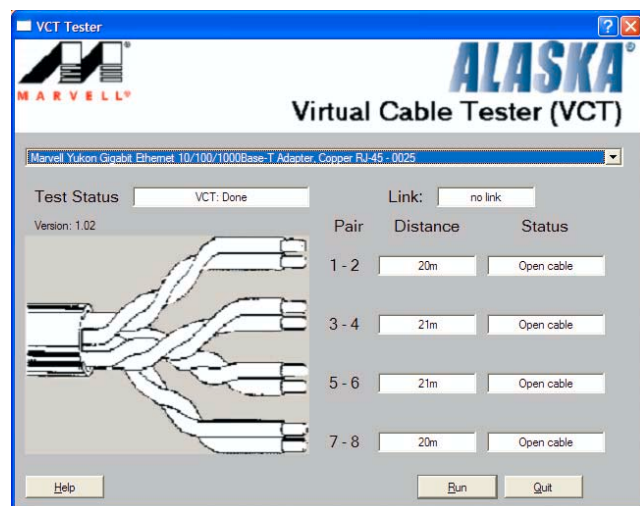

3. Click the **Run** button to perform a cable test.



- The VCT only runs on systems with Windows® XP or Windows® 2000 operating systems.
- The **Run** button on the Virtual Cable Tester™ main window is disabled if no problem is detected on the LAN cable(s) connected to the LAN port(s).
- If you want the system to check the LAN cable before entering the OS, enable the **POST Check LAN cable** item in the BIOS. See section “4.4.6 LAN Cable Status” for details.

5.3.3 Audio configurations

The Realtek® ALC850 AC '97 audio CODEC provides 8-channel audio capability to deliver the ultimate audio experience on your PC. The software provides Jack-Sensing function (Line-In, Line-Out, Mic-In), S/PDIF out support and interrupt capability. The ALC850 also includes the Realtek® proprietary UAJ® (Universal Audio Jack) technology for three ports (Line-In, Line-Out and Mic-In), eliminating cable connection errors and giving users plug and play convenience.

Follow the installation wizard to install the **Realtek ALC850 Audio Driver and Application** from the support CD that came with the motherboard package.

If the Realtek audio software is correctly installed, you will find the SoundEffect icon on the taskbar.

From the taskbar, double-click on the **SoundEffect** icon to display the **Realtek Audio Control Panel**.



Realtek SoundEffect icon



The Jack-sensing and UAJ® technology features are supported on the Line-In, Line-Out, and Mic jacks only.

Sound Effect options

The Realtek® ALC850 Audio CODEC allows you to set your listening environment, adjust the equalizer, set the karaoke, or select pre-programmed equalizer settings for your listening pleasure.

To set the sound effect options:

1. From the Realtek Audio Control Panel, click the **Sound Effect** button.
2. Click the shortcut buttons to change the acoustic environment, adjust the equalizer, or set the karaoke to your desired settings.
3. The audio settings take effect immediately after you click on the buttons.
4. Click the Exit (**X**) button on the upper-right hand corner of the window to exit.



S/PDIF option

The Sony/Philips Digital Interface (S/PDIF) options allows you to change your S/PDIF output settings.

To set the S/PDIF options:

1. From the Realtek Audio Control Panel, click the **SPDIF** button.
2. Click the option buttons to change your S/PDIF out settings.
3. Click the Exit (**X**) button on the upper-right hand corner of the window to exit.



Speaker Configuration

This option allows you to set your speaker configuration.

To set the speaker configuration:

1. From the Realtek Audio Control Panel, click the **Speaker Configuration** button.
2. Select from the combo list box your current speaker setup, then click **Auto Test** to test your settings.
3. Click the **UAJ Automatic** button to enable or disable the Universal Audio Jack(UAJ®) technology feature.
4. Click the Exit (X) button on the upper-right hand corner of the window to exit.

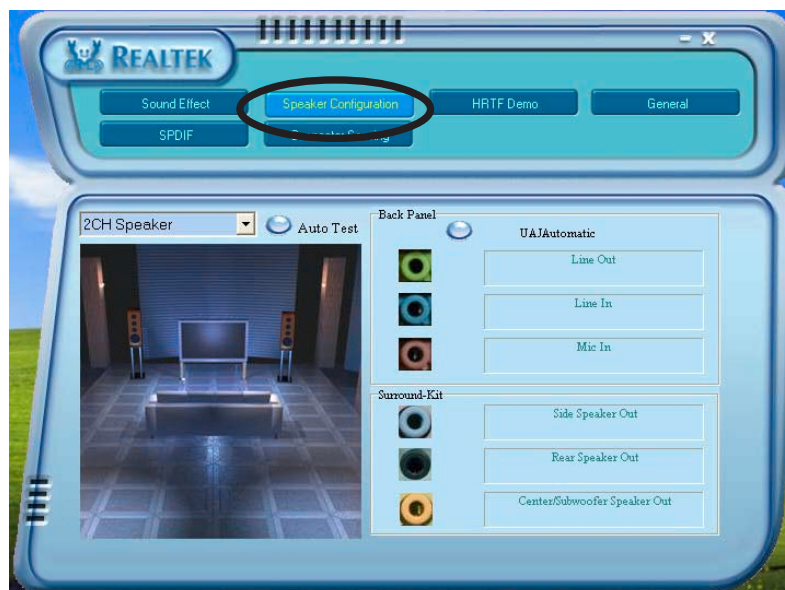

AI Audio feature

The AI Audio feature works through the connector sensing option that allows you to check if your audio devices are connected properly.

To start the connector sensing:

1. From the Realtek Audio Control Panel, click the **Connector Sensing** button.
2. Click the **Bracket** button to display connected audio devices.
3. Click the **Option** button to change sensing options.
4. Click the **Start** button to start connection sensing. A progress bar displays current connector sensing status.



Make sure to exit all audio applications before starting this function.



5. When finished, the utility prompts the Realtek® EZ-connection dialog box showing your current audio connections. The text at the bottom of the box explains your audio connection status. An *X* mark denotes an incorrect connection.

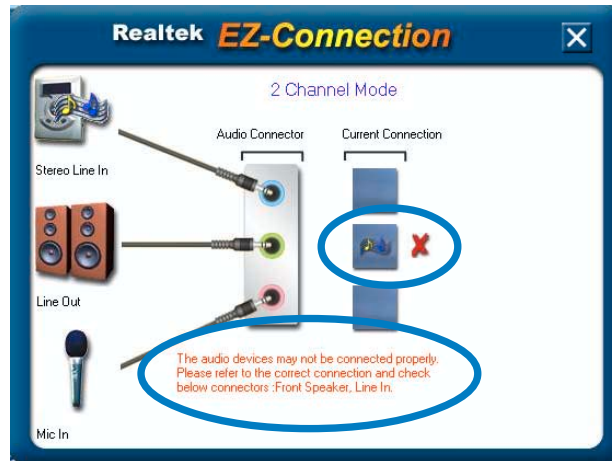

6. If there are detected problems, make sure that your audio cables are connected to the proper audio jack and repeat connector sensing.
7. Click the **X** button to exit EZ-connection dialog box.
8. Click the Exit (**X**) button on the upper-right hand corner of the window to exit audio control panel.

HRTF Demo

This option shows a demo of the Head-Related Transfer Functions (HRTF).

To start the HRTF demo:

1. From the Realtek Audio Control Panel, click the **HRTF Demo** button.
2. Click the option buttons to change the sound, moving path or EAX settings.
3. Click the **Play** button to start or the **Stop** button to stop.
4. Click the Exit (**X**) button on the upper-right hand corner of the window to exit.

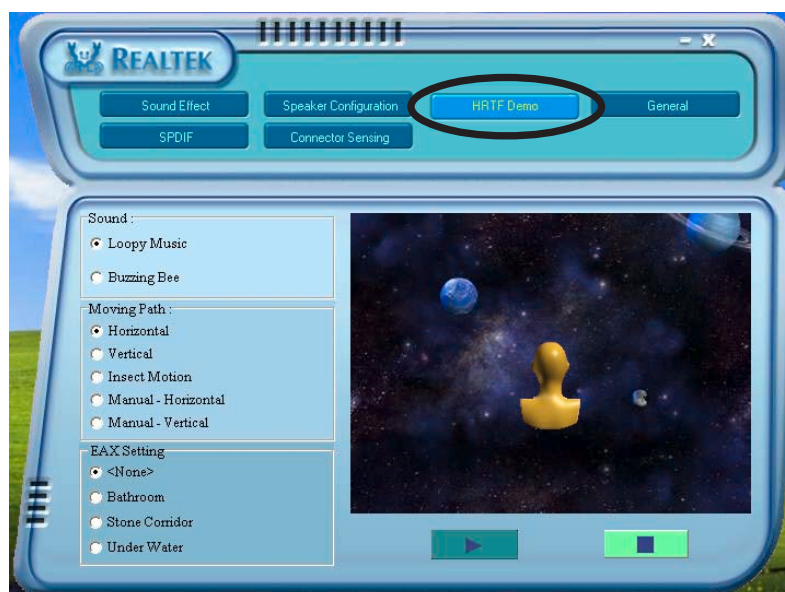

General settings

This option shows the audio settings and allows you to change the language setting or toggle the SoundEffect icon display on the Windows taskbar.

To display the general settings:

1. From the Realtek Audio Control Panel, click the **General** button.
2. Click the option button to enable or disable the icon display on the Windows taskbar.
3. Click the **Language** combo list box to change language display.
4. Click the Exit (X) button on the upper-right hand corner of the window to exit.



Rear panel audio ports function variation

The functions of the Line Out (lime), Line In (blue), Mic (pink), Rear Speaker Out (gray), Side Speaker Out (black), and Center/Subwoofer (yellow orange) ports on the rear panel change when you select the 4-channel, 6-channel or 8-channel audio configuration as shown in the following table. See the 8, 6, 4 or 2-channel speaker configuration on page 2-20.

5.3.4 Using the NVIDIA® Firewall™

The motherboard supports the NVIDIA® Firewall™ (NVFirewall™) application that protects your computer from intruders. The NVFirewall™ is classified as a personal firewall or desktop firewall that works at the device level to protect your system from malicious computer code by controlling the connections to and from your computer and alerting you for attempted intrusions. The following sections describe how to use the NVIDIA® Firewall™.

Launching the NVFirewall™ summary

After you install the NVFirewall™ application from the motherboard support CD, it is automatically activated with a **Medium** security profile as its default setting. The setup summary of NVFirewall™ is displayed in the summary menu.

To launch the NVFirewall™ summary menu:

1. Click the **NVIDIA® Firewall™ icon** from the Windows® taskbar.



NVIDIA® Firewall™ icon

2. Double-click the icon to display the NVFirewall™ Summary menu.

Click to select firewall profile

Click to view profile details

Click to view the firewall log

Click to view the firewall stats

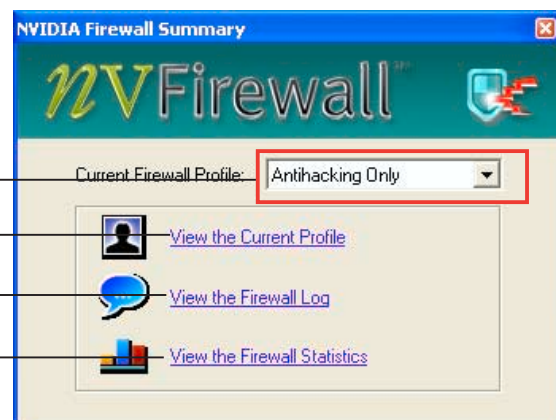

Setting security profiles

The NVFirewall™ application allows several security profiles to match your system security needs. The following describes the NVFirewall™ security profiles:

- **Low** - allows safe incoming connections and deny those that are known to be dangerous connections. This profile also enables some anti-hacking features.
- **Medium** - blocks most incoming connections. Incoming connections to some ports must be set to allow file transfers using some online messaging applications. This profile also enables some anti-hacking features.
- **High** - allows the least traffic through. Only outbound connections are allowed. This profile also includes the “stealth mode” feature that makes your system invisible to intruders. This also enables some anti-hacking features.
- **Lockdown** - blocks all incoming and outgoing connections.
- **Anti-hacking only** - this profile enables all anti-hacking features but disables the firewall. This security profile is useful if you want to use a third-party firewall application.
- **Custom 1, 2, 3** - these are reserved for customized profiles.
- **Off** - deactivates the firewall.

To set a security profile:

1. From the NVFirewall™ summary menu, click the **Current Firewall Profile** combo list box then select a security profile. The following confirmation box appears.
2. Click **Change Profile** to apply settings or **Don't Change Profile** to return to previous menu.



Turning the NVFirewall™ off



Take caution when using this option, your computer becomes vulnerable to viruses, hackers or intruders after you turn off the firewall.

To turn off the NVFirewall™:

1. From the NVIDIA Firewall™ summary menu, click the **Current Firewall Profile** combo list box then select **Off**. The following confirmation box appears.

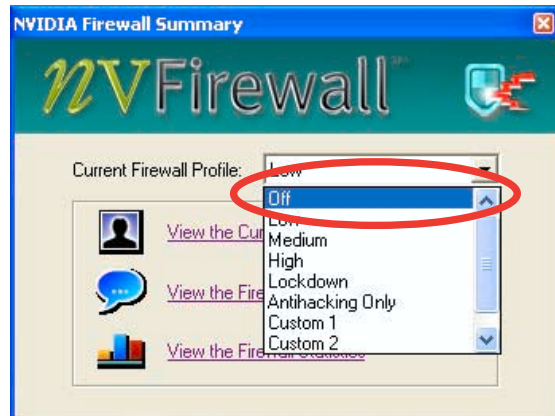

2. Click **Turn Firewall OFF**.

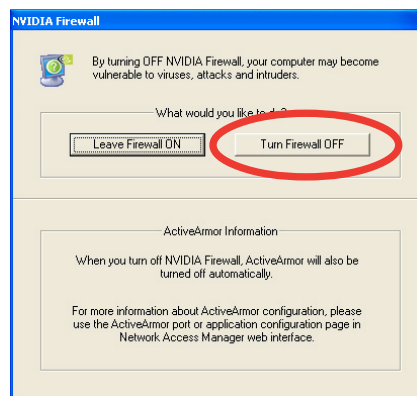

5.4 RAID configurations

The motherboard comes with the Silicon Image Sil3114 and the NVIDIA® SLI Southbridge RAID controllers that allow you to configure IDE and Serial ATA hard disk drives as RAID sets. The motherboard supports the following RAID configurations.

RAID 0 (*Data striping*) optimizes two identical hard disk drives to read and write data in parallel, interleaved stacks. Two hard disks perform the same work as a single drive but at a sustained data transfer rate, double that of a single disk alone, thus improving data access and storage. Use of two new identical hard disk drives is required for this setup.

RAID 1 (*Data mirroring*) copies and maintains an identical image of data from one drive to a second drive. If one drive fails, the disk array management software directs all applications to the surviving drive as it contains a complete copy of the data in the other drive. This RAID configuration provides data protection and increases fault tolerance to the entire system. Use two new drives or use an existing drive and a new drive for this setup. The new drive must be of the same size or larger than the existing drive.

RAID 0+1 is *data striping* and *data mirroring* combined without parity (redundancy data) having to be calculated and written. With the RAID 0+1 configuration you get all the benefits of both RAID 0 and RAID 1 configurations. Use four new hard disk drives or use an existing drive and three new drives for this setup.

RAID 5 stripes both data and parity information across three or more hard disk drives. Among the advantages of RAID 5 configuration include better HDD performance, fault tolerance, and higher storage capacity. The RAID 5 configuration is best suited for transaction processing, relational database applications, enterprise resource planning, and other business systems. Use a minimum of three identical hard disk drives for this setup.

RAID 10 is a striped configuration with each stripe a RAID 1 array of drives. It combines the features of both RAID 1 and RAID 0. Fault tolerance is provided through *mirroring* while adding performance through *striping*. This offers higher performance than a RAID 1 configuration but at a much higher cost. A minimum of four hard disk drives is required for this setup.

JBOD (*Spanning*) stands for **Just a Bunch of Disks** and refers to hard disk drives that are not yet configured as a RAID set. This configuration stores the same data redundantly on multiple disks that appear as a single disk on the operating system. Spanning does not deliver any advantage over using separate disks independently and does not provide fault tolerance or other RAID performance benefits.



If you want to boot the system from a hard disk drive included in a RAID set, copy first the RAID driver from the support CD to a floppy disk before you install an operating system to a selected hard disk drive. Refer to section “5.6 Creating a RAID driver disk” for details.

5.4.1 Installing hard disks

The motherboard supports Ultra DMA /133/100/66 and Serial ATA hard disk drives. For optimal performance, install identical drives of the same model and capacity when creating a disk array.

Installing Parallel ATA hard disks

To install IDE hard disks for a RAID configuration:

1. Set the jumpers of each hard disk as Master/Master or Slave/Slave.
2. Install the hard disks into the drive bays.
3. Connect the HDD signal cables.
4. Connect a 4-pin power cable to the power connector on each drive.

Installing Serial ATA (SATA) hard disks

To install the SATA hard disks for a RAID configuration:

1. Install the SATA hard disks into the drive bays.
2. Connect the SATA signal cables.
3. Connect a SATA power cable to the power connector on each drive.



Refer to the RAID controllers user manual in the motherboard support CD for detailed information on RAID configurations. See section “5.2.4 Manuals menu”.

5.4.2 NVIDIA® RAID configurations

The motherboard includes a high performance IDE RAID controller integrated in the NVIDIA® SLI southbridge chipset. It supports RAID 0, RAID 1, RAID 0+1, RAID 5 and JBOD with four independent Serial ATA channels.

Setting the BIOS RAID items

After installing the hard disk drives, make sure to set the necessary RAID items in the BIOS before setting your RAID configuration.

To set the BIOS RAID items:

1. Boot the system and press during the Power-On Self-Test (POST) to enter the BIOS Setup Utility.
2. From the **Advanced > Onboard Devices Configuration > NVRAID Configuration** menu item in the BIOS set the **RAID Enabled** item to Enabled. The succeeding items become user-configurable.
3. Select and enable the IDE or SATA drive(s) that you want to configure as RAID. See section “4.4.3 Onboard Devices Configuration” for details.
4. Save your changes and Exit Setup.



-
- For detailed descriptions on the NVIDIA® RAID configuration, refer to the “NVIDIA® RAID User’s Manual” found in your motherboard support CD.
 - When using Windows 2000 operating system, make sure to install the Windows 2000 Service Pack 4 or later versions.
-

Entering the NVIDIA® RAID utility

To enter the NVIDIA® RAID utility:

1. Boot up your computer.
2. During POST, press <F10> to display the main menu of the utility.



The RAID BIOS setup screens shown in this section are for reference only, and may not exactly match the items on your screen.

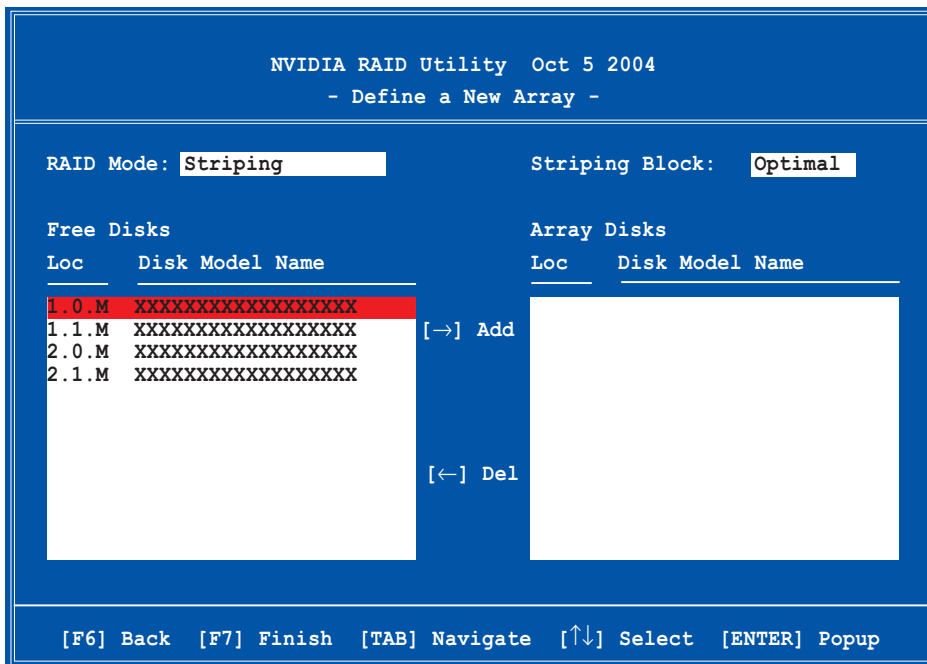

At the bottom of the screen are the navigation keys. These keys allow you to move through and select menu options.

Creating a RAID Volume

To create a RAID volume:

1. From the NVIDIA® RAID utility Define a New Array menu, select **RAID Mode** then press <Enter>. The following submenu appears.

Use the up or down arrow keys to select a RAID mode then press <Enter>.

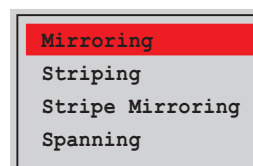

2. Press <TAB> select the Striping Block then press <Enter>. The following submenu appears:

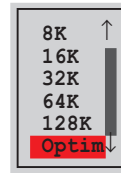

If you selected Striping or Stripe Mirroring, use the up or down arrow keys to select the stripe size for your RAID 0 array then press <Enter>. The available values range from 8 KB to 128 KB. The default selection is 128 KB. The strip value should be chosen based on the planned drive usage.

- 8 /16 KB - low disk usage
- 64 KB - typical disk usage
- 128 KB - performance disk usage



TIP: For server systems, we recommend using a lower array block size. For multimedia computer systems used mainly for audio and video editing, we recommend a higher array block size for optimum performance.

3. Press <TAB> to select the Free Disks area. Use the left or right arrow keys to assign the array disks.
4. Press <F7> to create RAID set. The following message box appears.

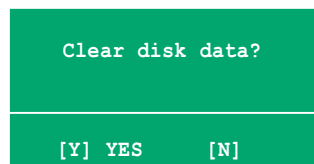

5. Press <Y> to clear the selected disks or <N> to proceed without clearing the disks. The following screen appears.



Take caution in using this option. All data on the RAID drives will be lost!

```

NVIDIA RAID Utility  Oct 5 2004
- Array List -

  Boot  Id  Status  Vendor  Array Model Name
  ----  -  -  -  -
No    4  Healthy  NVIDIA  MIRROR  XXX.XXG

[Ctrl-X]Exit  [↑↓]Select  [B]Set Boot  [N]New Array  [ENTER]Detail

```

A new set of navigation keys is displayed on the bottom of the screen.

6. Press <Ctrl+X> to save settings and exit.

Rebuilding a RAID array

To rebuild a RAID array:

1. From the Array List menu, use the up or down arrow keys to select a RAID array then press <Enter>. The RAID Array details appear.

```

Array 1 : NVIDIA MIRROR  XXX.XXG
- Array Detail -

RAID Mode: Mirroring
Striping Width: 1          Striping Block: 64K

  Adapt  Channel  M/S      Index  Disk Model Name      Capacity
  ----  -  -  -  -  -
  2      1      Master   0      XXXXXXXXXXXXXXXXXXXX  XXX.XXGB
  1      0      Master   1      XXXXXXXXXXXXXXXXXXXX  XXX.XXGB

[R] Rebuild  [D] Delete  [C] Clear Disk  [ENTER] Return

```

A new set of navigation keys is displayed on the bottom of the screen.

2. Press <R> to rebuild a RAID array. The following screen appears.

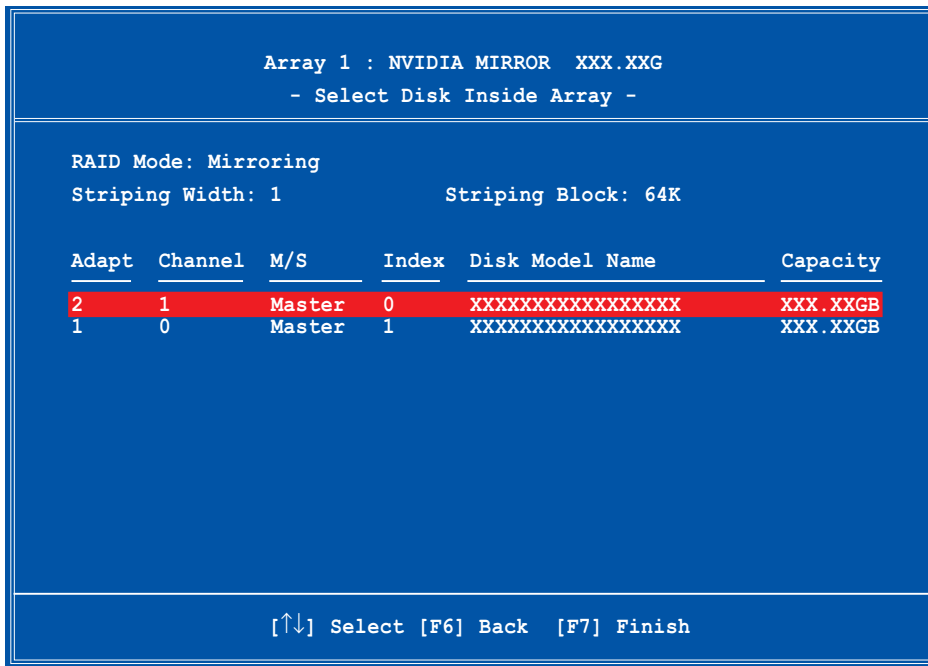

3. Use the up or down arrow keys to select a RAID array to rebuild, then press <F7>. The following confirmation message appears.

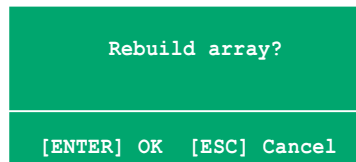

4. Press <Enter> to start rebuilding array or press <Esc> to cancel.
5. After the rebuild process, the Array list menu appears.

Deleting a RAID array

To delete a RAID array:

1. From the Array List menu, use the up or down arrow keys to select a RAID array then press <Enter>. The RAID Array details appear.

```
Array 1 : NVIDIA MIRROR XXX.XXG
- Array Detail -

RAID Mode: Mirroring
Striping Width: 1          Striping Block: 64K

Adapt  Channel  M/S      Index  Disk Model Name      Capacity
-----  -
2       1          Master   0      XXXXXXXXXXXXXXXXXXXX  XXX.XXGB
1       0          Master   1      XXXXXXXXXXXXXXXXXXXX  XXX.XXGB

[R] Rebuild [D] Delete [C] Clear Disk [ENTER] Return
```

A new set of navigation keys is displayed on the bottom of the screen.

2. Press <D> to delete a RAID array. The following confirmation message appears.

```
Delete this array?

[Y] YES [N] No
```

3. Press <Y> to delete array or press <N> to cancel.



Take caution in using this option. All data on the RAID drives will be lost!

4. If you selected Yes, the Define a New Array menu appears.

Clearing a disk data

To clear disk data:

1. From the Array List menu, use the up or down arrow keys to select a RAID array then press <Enter>. The RAID Array details appear.

```
Array 1 : NVIDIA MIRROR XXX.XXG
- Array Detail -

RAID Mode: Mirroring
Striping Width: 1          Striping Block: 64K

Adapt  Channel  M/S      Index  Disk Model Name      Capacity
-----  -
2       1          Master    0      XXXXXXXXXXXXXXXXXXXX  XXX.XXGB
1       0          Master    1      XXXXXXXXXXXXXXXXXXXX  XXX.XXGB

[R] Rebuild [D] Delete [C] Clear Disk [ENTER] Return
```

A new set of navigation keys is displayed on the bottom of the screen.

2. Press <C> to clear disk. The following confirmation message appears.

```
Clear disk data?

[Y] YES [N]
```

5. Press <Y> to clear the disk data or press <N> to cancel.



Take caution in using this option. All data on the RAID drives will be lost!

5.4.3 Silicon Image RAID configurations

The Silicon Image RAID controller supports RAID 0, RAID 1, RAID 10, JBOD, and RAID 5 configurations. Use the Silicon Image RAID utility to configure a disk array.

Setting the BIOS RAID items

After installing the hard disk drives, make sure to set the necessary RAID items in the BIOS before setting your RAID configuration.

To set the BIOS RAID items:

1. Boot the system and press during the Power-On Self-Test (POST) to enter the BIOS Setup Utility.
2. From the **Advanced > Onboard Devices Configuration** menu item in the BIOS set the **Silicon Image Controller** item to RAID Mode. See section “4.4.6 Onboard Devices Configuration” for details.
3. Save your changes and Exit Setup.

Launching the Silicon Image Array Management Software

Launch the Silicon Image Array Management software from Windows® XP by clicking the **Start** button and selecting **All Programs > Silicon Image > Sam**



-
- For details on the Silicon Image SATAraid™ RAID configuration, refer to the “Sil3132 User’s Manual” in your motherboard support CD.
-
- You can only set the SATALink™ RAID 5 and JBOD configuration using the SATALink™ SATA RAID Management Software.
-
- Make sure to install the Silicon Image SATA Link Sil 3132 driver and the Silicon Image RAID 5 Array Management Utility from the support CD before using RAID 5 configuration.
-

Entering the Silicon Image BIOS RAID Configuration Utility

To enter the Silicon Image BIOS RAID configuration utility:

1. Boot up your computer.
2. During POST, press <Ctrl+S> or <F4>.



The RAID BIOS setup screens shown in this section are for reference only, and may not exactly match the items on your screen.

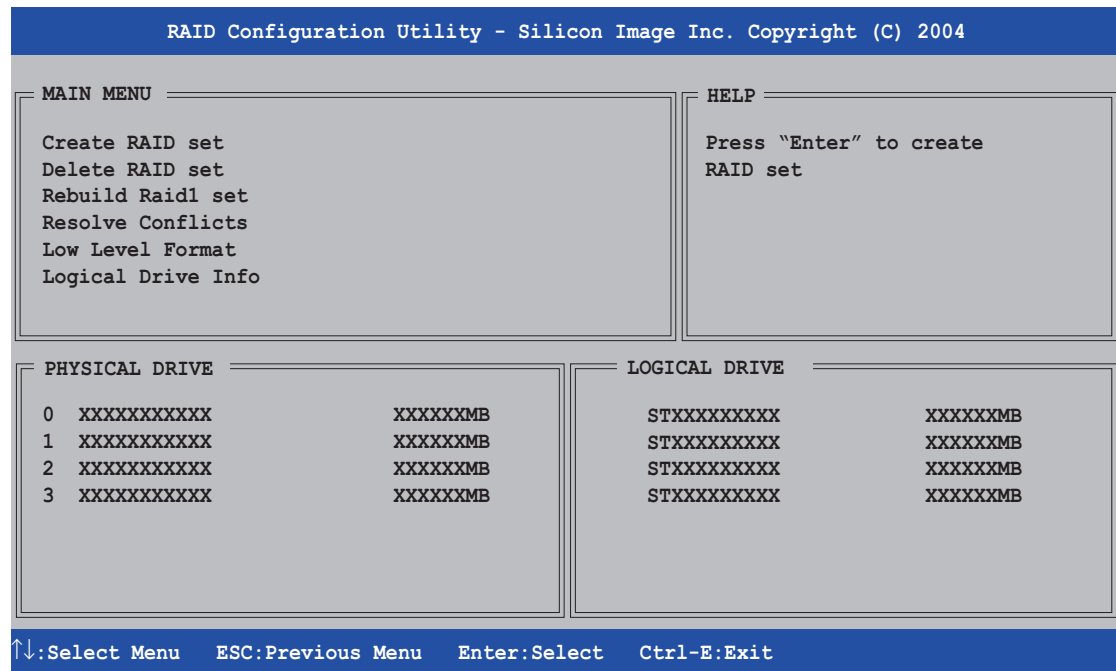

The Main Menu on the upper left corner allows you to select an operation to be performed. The Main Menu options include the following:

Create RAID set - creates a new legacy RAID set or allocates spare drives.

Delete RAID set - deletes a RAID set or deallocates a spare drive.

Rebuild RAID1 set - rebuilds a RAID 1 set (e.g. swapped drives).

Resolve Conflicts - automatically restores disrupted drives on a RAID set.

Low Level Format - creates a pattern of reference marks on a drive.

Formatting the disks erases all data previously stored in the drive.

Logical Drive Info - shows the current configuration of each RAID set.

On the upper right corner of the screen is the Help message box. The message describes the function of each menu item. At the bottom of the screen is the legend box. The keys on the legend box allow you to navigate through the setup menu options. The following lists the keys found in the legend box and their corresponding functions.

↑, ↓ : Select/Move to the next item

ESC : Previous Menu

Enter : Select

Ctrl-E : Exit

Creating a RAID 0 set (Striped)

To create a RAID set:

1. From the Silicon Image configuration utility main menu, select **Create RAID set** then press <Enter> to display an option menu.

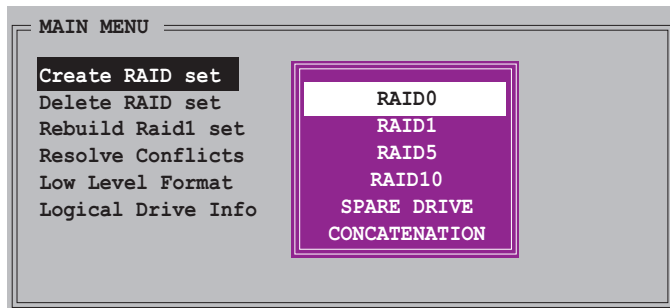

2. Select **RAID 0** then press <Enter> to display the following.

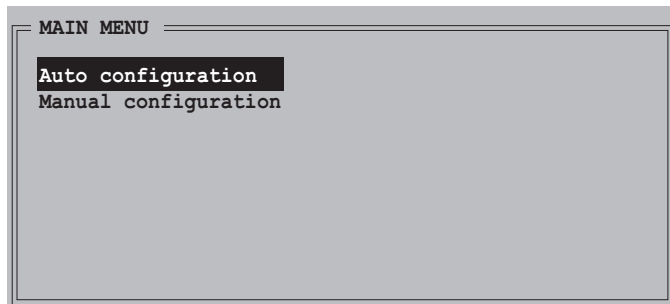

3. Select your desired method of configuration.
Auto configuration
 - a. Select Auto Configuration then press <Enter>.
 - b. The utility prompts a message to input the RAID size, use the up or down arrow keys to set the RAID size then press <Enter>.
 - c. Press <Y> to confirm or <N> to return to the Main Menu.



By default, Auto configuration sets the stripe size to 64K and sets the logical drives based on the physical drives installed.

Manual configuration

- a. Select **Manual configuration** and press <Enter>. The following pop-up menu appears.
- b. Use the up or down arrow keys to select a chunk size appropriate to your drive usage then press <Enter>.

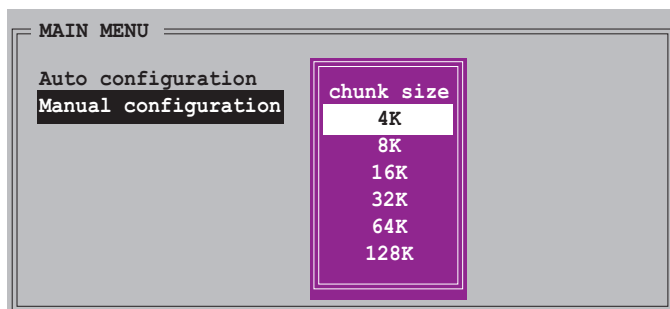



TIP: For server systems, we recommend using a lower array block size. For multimedia computer systems used mainly for audio and video editing, we recommend a higher array block size for optimum performance.

- c. The selection bar moves to the Physical Drive menu. Using the up or down arrow keys, select a drive then press <Enter> to set the first drive of the RAID set.

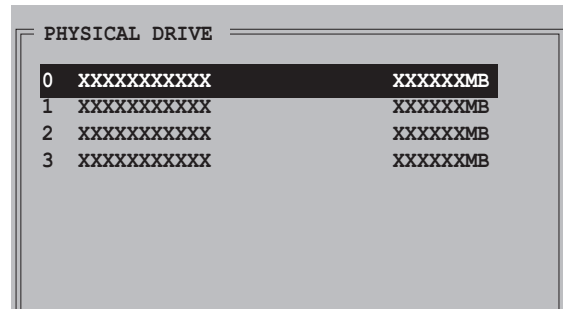

- d. Repeat step c to set the second, third, and fourth drive. The number of available drives depend on the installed and enabled physical drives in the system.
- e. The utility prompts a message to input the RAID size, use the up or down arrow keys to set the RAID size then press <Enter>.
- f. Press <Y> to confirm or <N> to return to the Main Menu.

Creating a RAID 1 set (Mirrored)

To create a RAID 1 set:

1. From the Silicon Image configuration utility main menu, select **Create RAID set** then press <Enter>. The following sub-menu appears.

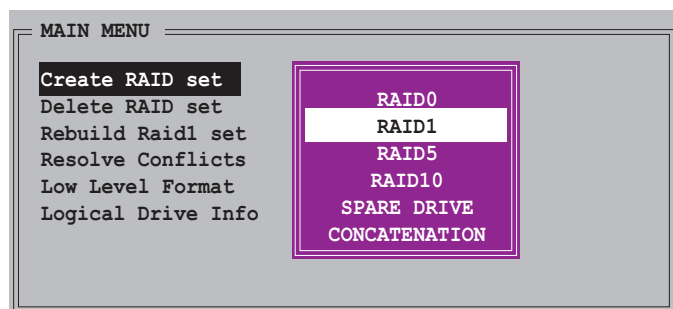

2. Select **RAID 1** then press <Enter> to display the following.

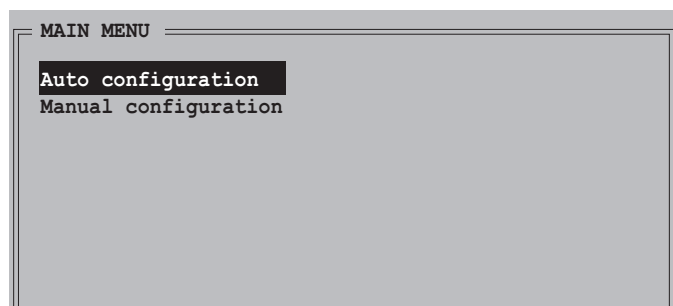

3. Select your desired method of configuration.

Auto configuration

- a. Select Auto Configuration then press <Enter>.
- b. The utility prompts a message to input the RAID size, use the up or down arrow keys to set the RAID size then press <Enter>.
- c. Press <Y> to confirm or <N> to return to the Main Menu.



- Auto-configuration creates a RAID 1 set without a backup copy of the current source disk data.
- When migrating a single hard disk drive to a RAID 1 set, use of the Manual configuration is recommended.

Manual configuration

- a. Select **Manual configuration** and press <Enter>. The selection bar moves to the Physical Drives menu.
- b. Using the up or down arrow keys, select the *source drive* and press <Enter>.
- c. Repeat step b to select the *target drive*.
- d. After selecting the source and target drives, the following pop-up menu appears.

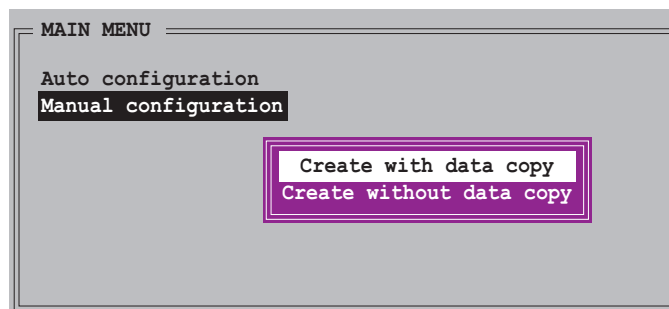
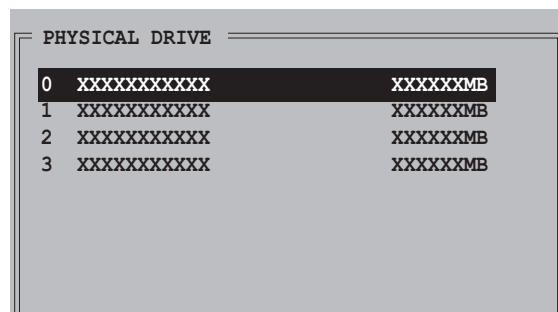

- The **Create with data copy** option allows you to copy the current data from the source drive to the mirror drive.
- Select **Create with data copy** if you have important data in your source drive.
- The **Create without data copy** option disables the disk copy function of the Mirrored set.
- If you selected **Create without data copy**, the RAID 1 set must be repartitioned and reformatted to guarantee the consistency of its contents.

- e. If you selected **Create with data copy**, the following pop-up menu appears.

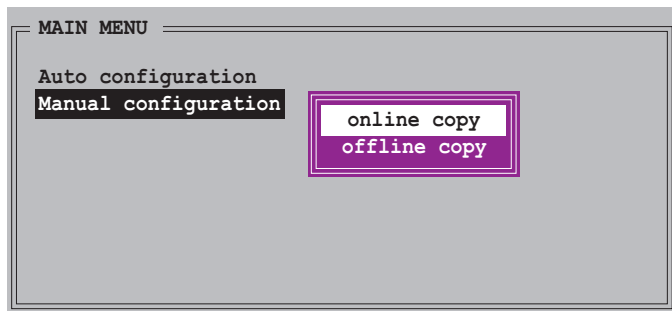

The **online copy** option automatically copies the data to the target drives on the background while writing to the source drives. The **offline copy** option allows you to copy the contents of the source drive to the target drives now.

- f. Use the up or down arrow keys to select desired copy method, then press <Enter>.
- g. The utility prompts a message to input the RAID size, use the up or down arrow keys to set the RAID size then press <Enter>.
- h. Press <Y> to confirm or <N> to return to the Main Menu.



A copy progress appears if you previously selected offline copy.

Creating a CONCATENATION set

To create a CONCATENATION set:

1. From the Silicon Image configuration utility main menu, select **Create RAID set** then press <Enter>.

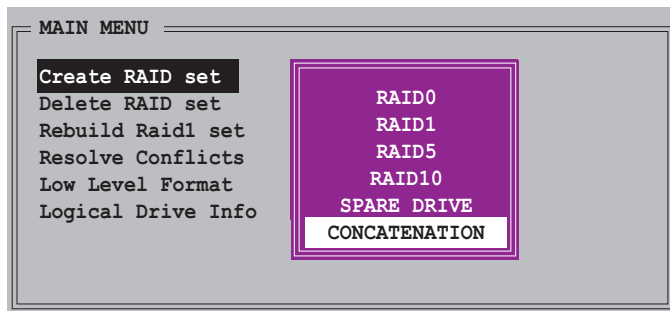

2. From the sub-menu Select **CONCATENATION** then press <Enter>.

3. The selection bar moves to the Physical Drive menu. Using the up or down arrow keys, select a drive then press <Enter> to set a drive for the RAID set.

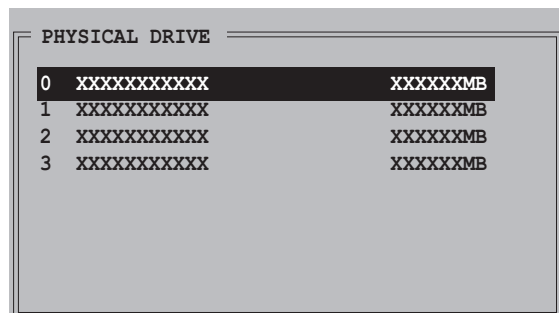

4. The utility prompts a message to input the RAID size, use the up or down arrow keys to set the RAID size then press <Enter>.

5. Press <Y> to confirm or <N> to return to the Main Menu.



- Configure a CONCATENATION set when using a single Serial ATA drive; otherwise, the system will not recognize the drive.
- You can also create a RAID set using the SATARAID5 GUI utility under a Windows® environment.

5.5 Creating a RAID driver disk

A floppy disk with the RAID driver is required when installing Windows® 2000/XP operating system on a hard disk drive that is included in a RAID set.

To create a RAID driver disk:

1. Place the motherboard support CD into the CD-ROM drive.
2. When the **Drivers** menu appears, select the RAID driver disk you want to create:
 - Click **Make NVIDIA RAID Driver** to create an NVIDIA® RAID driver disk.
 - Click **Make Silicon SATA RAID Driver Disk** to create a Silicon Image SATAraid™ RAID driver disk.

Or

Browse the contents of the support CD to locate the driver disk utility.

- Go to **\Drivers\Chipset\WINXP_2K\Driver_Disk** for the NVIDIA® RAID driver disk utility.
- Go to **\Drivers\Sil3132** for the Silicon Image RAID driver disk utility.



Refer to section “5.2.2 Drivers menu” for details.

4. Insert floppy disk to floppy disk drive.
5. Follow succeeding screen information to complete process.
6. Write-protect the floppy disk to avoid computer virus infection.

To install the RAID driver:

1. During the OS installation, the system prompts you to press the F6 key to install third-party SCSI or RAID driver.
2. Press <F6> then insert the floppy disk with RAID driver into the floppy disk drive.
3. Follow the succeeding screen instructions to complete the installation.



Due to chipset limitation, the Serial ATA ports supported by the NVIDIA chipset doesn't support Serial Optical Disk Drives (Serial ODD) under DOS.

This chapter tells how to install
SLI-ready PCI Express graphics cards.

NVIDIA® SLI™ **technology** **support**



Chapter summary

| | | |
|-----|---------------------------------|-----|
| 6.1 | Overview | 6-1 |
| 6.2 | Dual graphics cards setup | 6-2 |

6.1 Overview

The motherboard supports the NVIDIA® SLI™ (Scalable Link Interface) - Intel® Edition technology that allows you to install two identical PCI Express™ x16 graphics cards. Follow the installation procedures in this section.

Requirements

- You should have two identical SLI-ready graphics cards that are NVIDIA® certified.
- Visit the ASUS website (www.asus.com) for a list of qualified SLI-ready graphics cards for this motherboard.
- Make sure that your graphics card driver supports the NVIDIA SLI technology. Download the latest driver from the NVIDIA website (www.nvidia.com).
- Make sure that your power supply unit (PSU) can provide at least the minimum power required by your system. See “8. ATX power connectors” on page 2-34 for details.



-
- The NVIDIA SLI technology supports Windows® XP™ operating system only.
 - Due to chipset driver limitation, SLI mode is not supported under Windows XP 64-bit edition.
 - Visit the NVIDIA zone website (<http://www.nzone.com>) for the latest certified graphics card and supported 3D application list.
-

6.2 Dual graphics card setup

6.2.1 Setting the ASUS EZ selector card

Your motherboard package comes with a pre-installed ASUS EZ selector card. By default, the card is set for a single graphics card. To use two graphics cards on this motherboard, you must first set the selector card to **Dual Video Cards**.

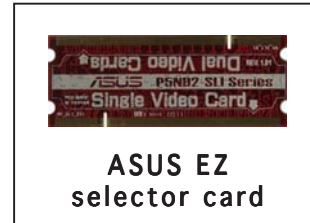

To set the selector card:

1. Locate the selector card on the motherboard.

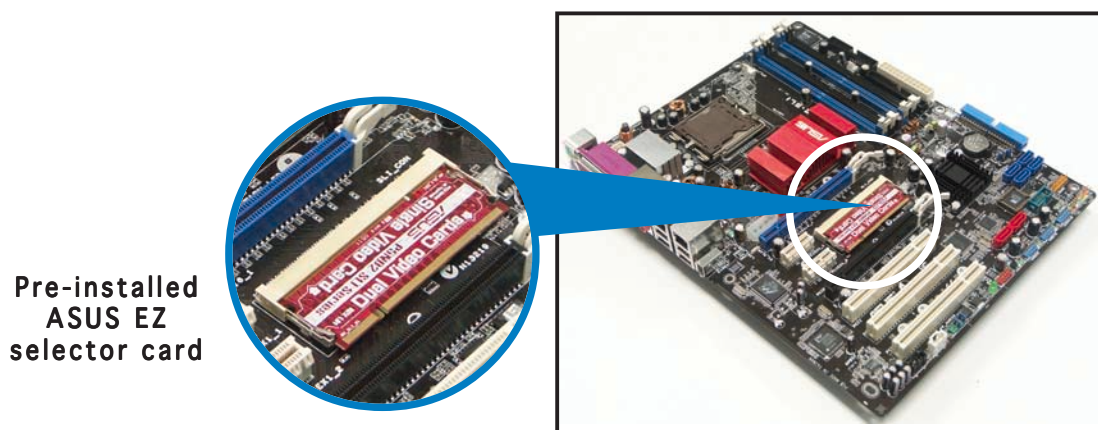

2. Simultaneously push the retention clips outward to release the card.

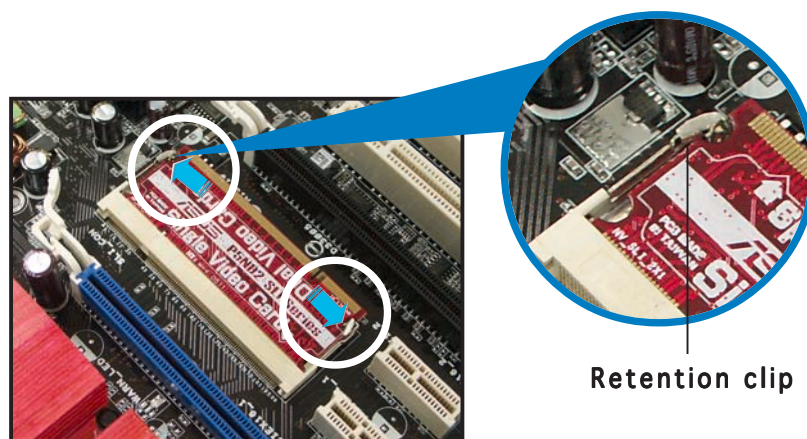

3. When released, pull the selector card out of the slot.

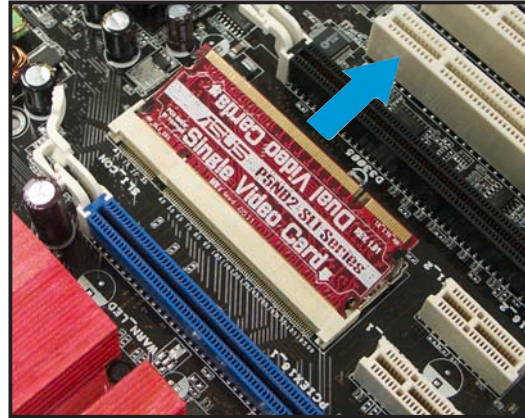

4. Invert the selector card and insert the edge labeled **Dual Video Cards**.

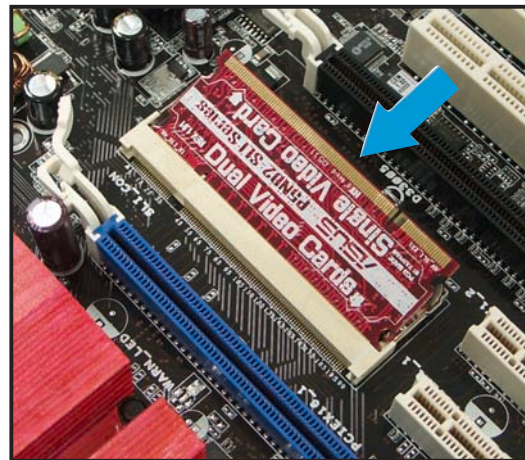

5. Push down the selector card until the retention clips snap into place.



Make sure to completely insert the selector card into the slot.

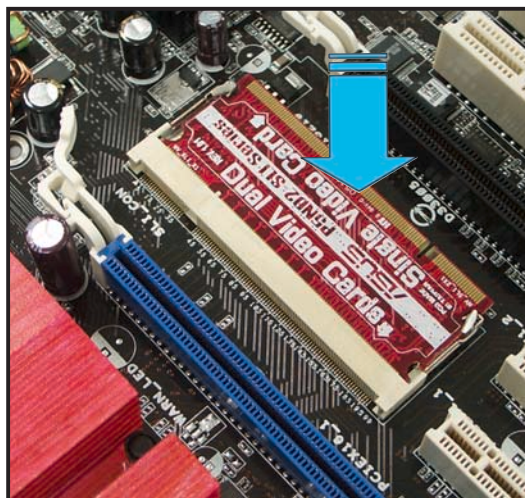

6.2.2 Installing SLI-ready graphics cards



Install only identical SLI-ready graphics cards that are NVIDIA® certified. Different types of graphics cards will not work together properly.

To install the graphics cards:

1. Prepare two graphics cards. Each graphics card should have goldfingers for the SLI connector.

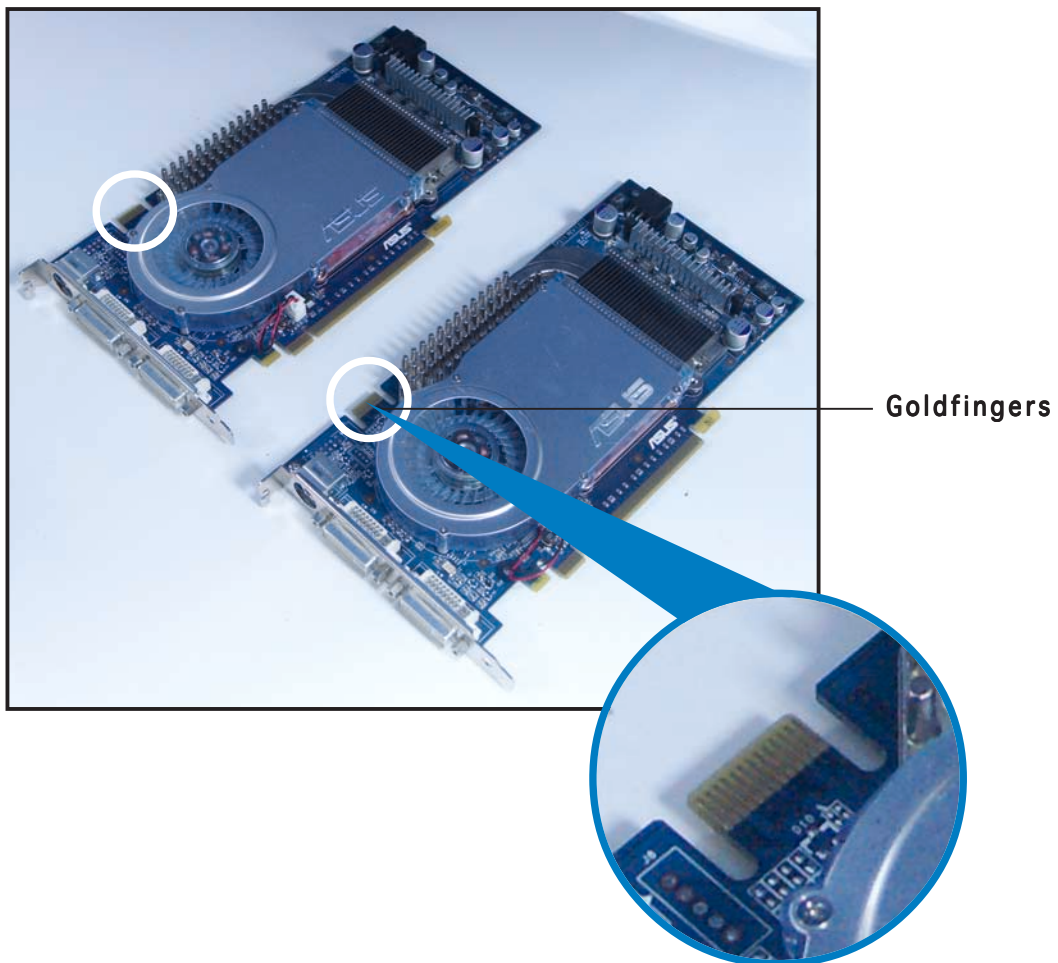

2. Remove the metal bracket covers opposite the two PCI Express x16 slots.

3. Insert one graphics card into the blue slot labeled **PCIEX16_1**. Make sure that the card is properly seated on the slot.

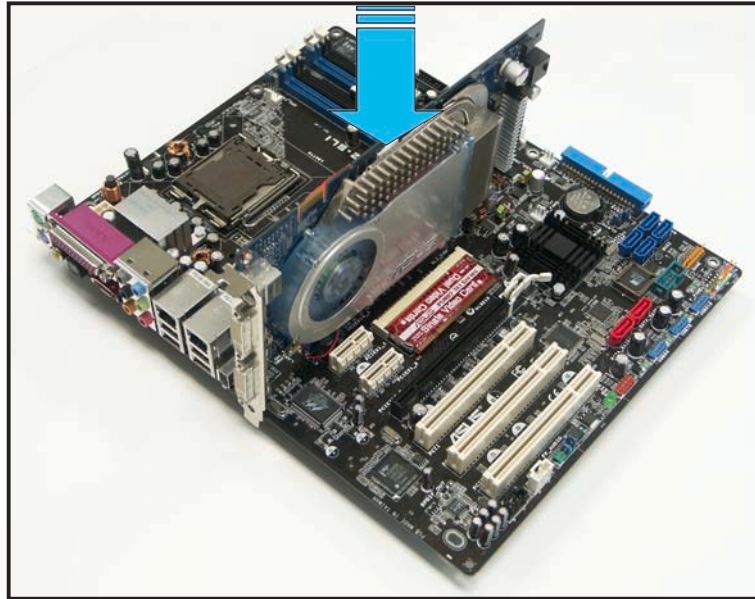

4. Insert the second graphics card into the black slot labeled **PCIEX16_2**. Make sure that the card is properly seated on the slot.

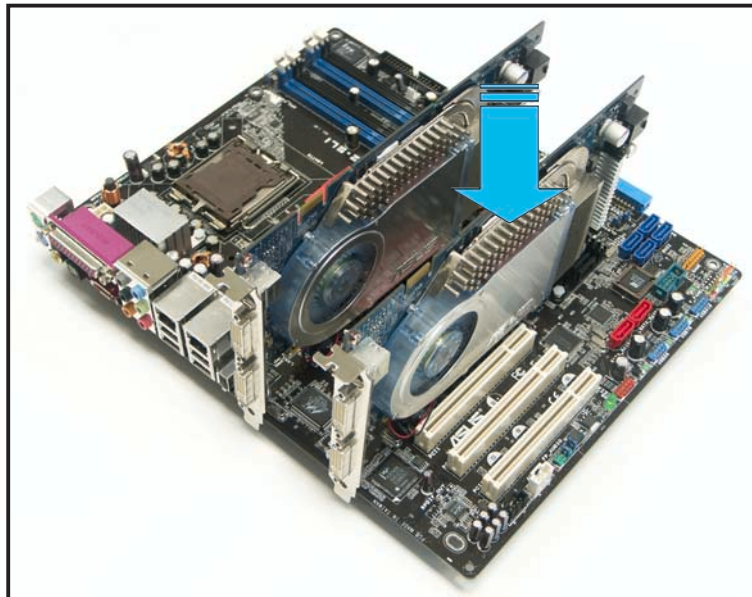

If required, connect an auxiliary power source to the PCI Express graphics cards.

5. Align and insert the SLI connector to the goldfingers on each graphics card. Make sure that the connector is firmly in place.

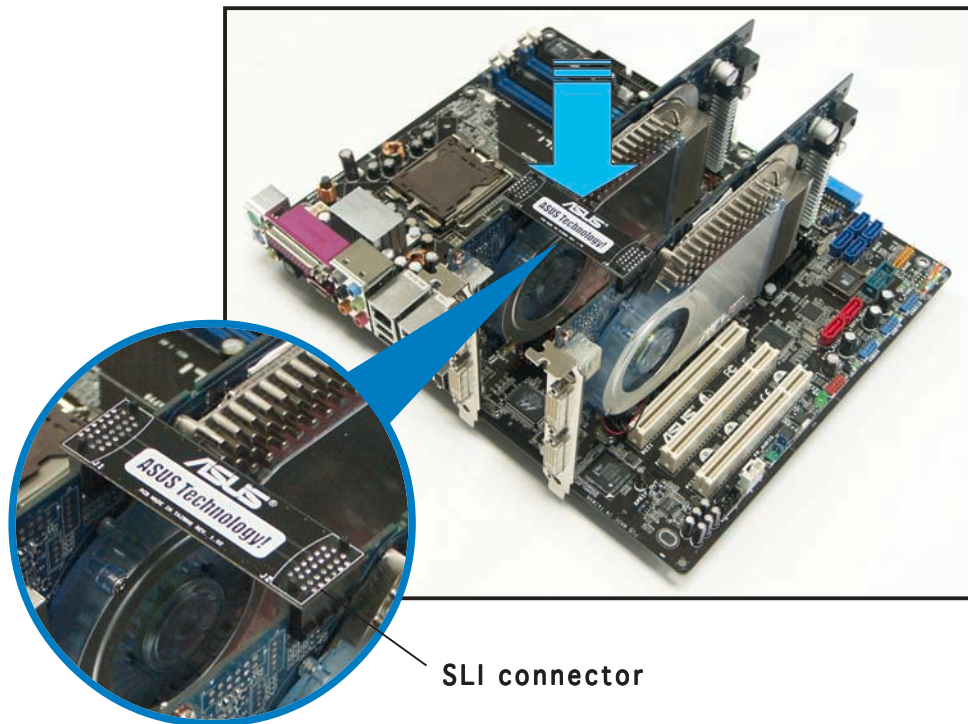

6. Connect a 4-pin ATX power cable to the EZ Plug™ labeled **EZ_PLUG** on your motherboard.



Make sure to connect a 4-pin ATX power cable to the EZ Plug; otherwise, the system will be unstable.

ASUS EZ Plug™

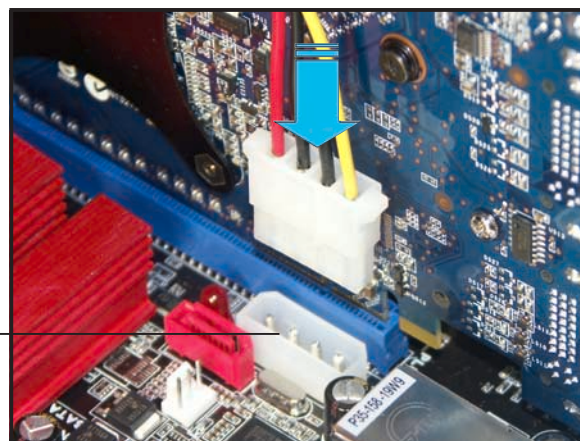

The onboard red warning LED lights up if you do not plug a 4-pin ATX power cable to the EZ Plug.

7. Remove any of the two bracket covers between the graphics cards.

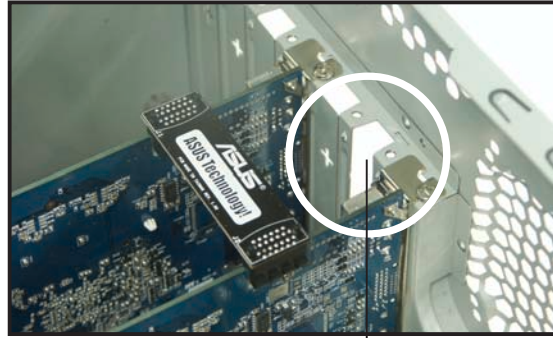

Bracket slot

8. Align and insert the retention bracket into the slot then secure it with a screw.



Make sure that the retention bracket firmly supports the two graphics cards.

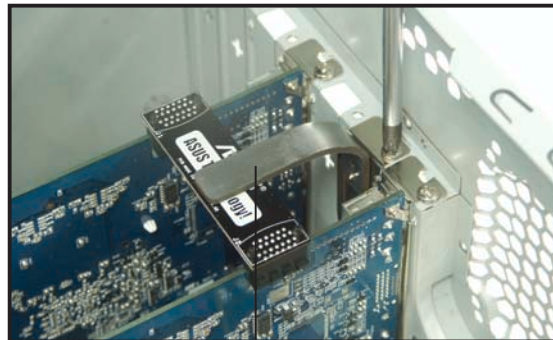

Retention bracket

9. Connect a **VGA cable** or a **DVI-I cable** to the graphics card installed on the **blue** PCI Express slot.



We recommend to install an additional chassis fan for better thermal environment.

6.2.3 Setting the SLI mode in BIOS

By default, the SLI mode item in the BIOS is set to [Auto]. This allows the BIOS to automatically detect the SLI selector card setting on the motherboard.



- We recommend that you keep the SLI mode item setting to [Auto].
- When not set to [Auto], make sure that the SLI mode BIOS setting is the same as the EZ selector card setting.
- See section “4.4.6 SLI Configuration” on page 4-28 for details.

6.2.4 Installing the device drivers

Refer to the documentation that came with your graphics card package to install the device drivers.



Make sure that your PCI Express graphics card driver supports the NVIDIA SLI technology. Download the latest driver from the NVIDIA website (www.nvidia.com).

6.2.5 Enabling the multi-GPU feature in Windows

After installing your graphics cards and the device drivers, enable the Multi-Graphics Processing Unit (GPU) feature in the NVIDIA nView properties.

To enable the multi-GPU feature:

1. Click the **NVIDIA Settings icon** on your Windows taskbar.
2. From the pop-up menu, select **nView Desktop Manager** then click **nView Properties**.



NVIDIA Settings icon

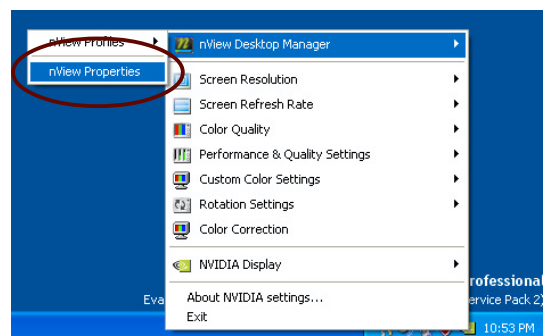

3. From the nView Desktop Manager window, select the **Desktop Management** tab.
4. Click **Properties** to display the Display Properties dialog box.

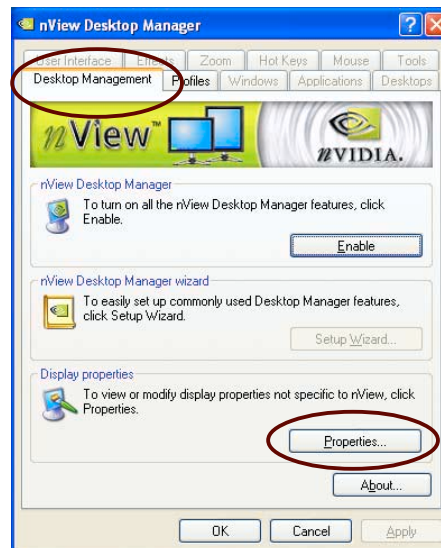

5. From the Display Properties dialog box, select the **Settings** tab then click **Advanced**.

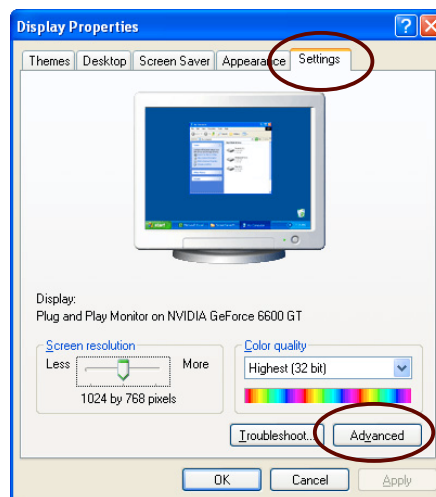

6. Select the **NVIDIA GeForce** tab.

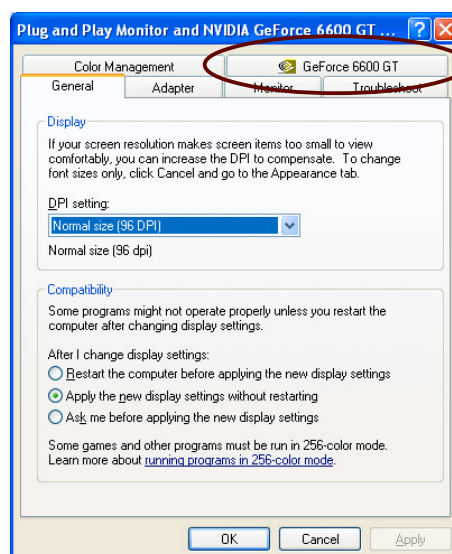

6. Click the slider to display the following screen, then select the **SLI multi-GPU** item.

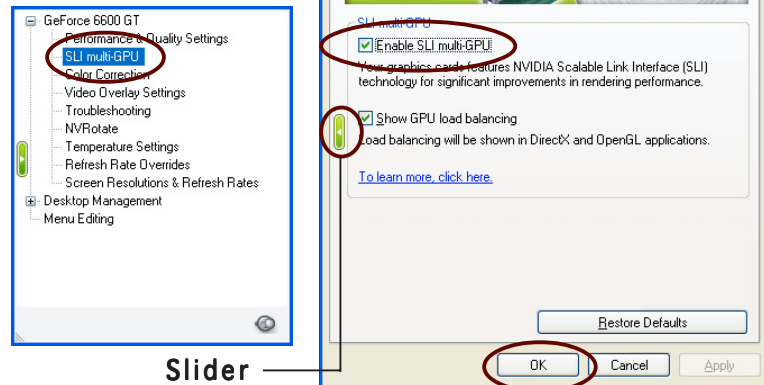

7. Click the **Enable SLI multi-GPU** check box.
8. Click **OK** when done.

The Appendix describes the CPU features that the motherboard supports.

Appendix A CPU features

Chapter summary



| | | |
|-----|---------------------------------------------------|-----|
| A.1 | Intel® EM64T | A-1 |
| A.2 | Enhanced Intel SpeedStep® Technology (EIST) | A-1 |
| A.3 | Intel® Hyper-Threading Technology | A-3 |

A.1 Intel® EM64T



-
- The motherboard is fully compatible with Intel® Pentium® 4 LGA775 processors running on 32-bit operating systems.
 - The motherboard comes with a BIOS file that supports EM64T. You can download the latest BIOS file from the ASUS website (www.asus.com/support/download/) if you need to update the BIOS file. See Chapter 4 for details.
 - Visit www.intel.com for more information on the EM64T feature.
 - Visit www.microsoft.com for more information on Windows® 64-bit OS.
-

Using the Intel® EM64T feature

To use the Intel® EM64T feature:

1. Install an Intel® Pentium® 4 CPU that supports the Intel® EM64T.
2. Install a 64-bit operating system (Windows® XP Professional x64 Edition or Windows® Server 2003 x64 Edition).
3. Install the 64-bit drivers for the motherboard components and devices from the support CD.
4. Install the 64-bit drivers for expansion cards or add-on devices, if any.



Refer to the expansion card or add-on device(s) documentation, or visit the related website, to verify if the card/device supports a 64-bit system.

A.2 Enhanced Intel SpeedStep® Technology (EIST)



-
- The motherboard comes with a BIOS file that supports EIST. You can download the latest BIOS file from the ASUS website (www.asus.com/support/download/) if you need to update the BIOS. See Chapter 4 for details.
 - Visit www.intel.com for more information on the EIST feature.
-

A.2.1 System requirements

Before using EIST, check your system if it meets the following requirements:

- Intel® Pentium® 4 processor with EIST support
- BIOS file with EIST support
- Operating system with EIST support (Windows® XP SP2/Windows® Server 2003 SP1/Linux 2.6 kernel or later versions)

A.2.2 Using the EIST

To use the EIST feature:

1. Turn on the computer, then enter the BIOS Setup.
2. Go to the **Advanced Menu**, highlight **CPU Configuration**, then press <Enter>.
3. Set the **Intel(R) SpeedStep Technology** item to [Automatic], then press <Enter>. See page 4-26 for details.
4. Press <F10> to save your changes and exit the BIOS setup.
5. After the computer restarts, right click on a blank space on the desktop, then select **Properties** from the pop-up menu.
6. When the **Display Properties** window appears, click the **Screen Saver** tab.
7. Click the **Power** button on the Monitor power section to open the **Power Options Properties** window.

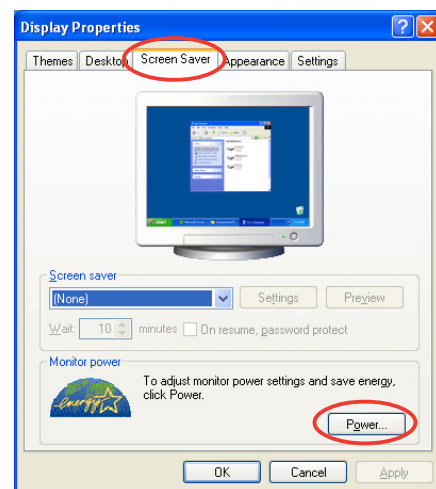

8. On the **Power schemes** section, click , then select any option **except Home/Office Desktop or Always On**.
9. Click **Apply**, then click **OK**.
10. Close the **Display Properties** window.

After you adjust the power scheme, the CPU internal frequency slightly decreases when the CPU loading is low.

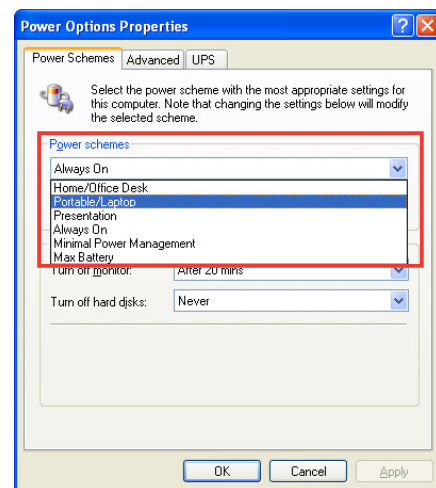

The screen displays and procedures may vary depending on the operating system.

A.3 Intel® Hyper-Threading Technology



- The motherboard supports Intel® Pentium® 4 LGA775 processors with Hyper-Threading Technology.
 - Hyper-Threading Technology is supported under Windows® XP/2003 Server and Linux 2.4.x (kernel) and later versions only. Under Linux, use the Hyper-Threading compiler to compile the code. If you are using any other operating systems, disable the Hyper-Threading Technology item in the BIOS to ensure system stability and performance.
 - Installing Windows® XP Service Pack 1 or later version is recommended.
 - Make sure to enable the Hyper-Threading Technology item in BIOS before installing a supported operating system.
 - For more information on Hyper-Threading Technology, visit www.intel.com/info/hyperthreading.
-

Using the Hyper-Threading Technology

To use the Hyper-Threading Technology:

1. Install an Intel® Pentium® 4 CPU that supports Hyper-Threading Technology.
2. Power up the system and enter the BIOS Setup. Under the **Advanced Menu**, make sure that the item **Hyper-Threading Technology** is set to **Enabled**. See page 4-26 for details.
The BIOS item appears only if you installed a CPU that supports Hyper-Threading Technology.
3. Restart the computer.

