

P5GD1



Motherboard

E1927

First Edition

January 2005

Copyright © 2005 ASUSTeK COMPUTER INC. All Rights Reserved.

No part of this manual, including the products and software described in it, may be reproduced, transmitted, transcribed, stored in a retrieval system, or translated into any language in any form or by any means, except documentation kept by the purchaser for backup purposes, without the express written permission of ASUSTeK COMPUTER INC. ("ASUS").

Product warranty or service will not be extended if: (1) the product is repaired, modified or altered, unless such repair, modification or alteration is authorized in writing by ASUS; or (2) the serial number of the product is defaced or missing.

ASUS PROVIDES THIS MANUAL "AS IS" WITHOUT WARRANTY OF ANY KIND, EITHER EXPRESS OR IMPLIED, INCLUDING BUT NOT LIMITED TO THE IMPLIED WARRANTIES OR CONDITIONS OF MERCHANTABILITY OR FITNESS FOR A PARTICULAR PURPOSE. IN NO EVENT SHALL ASUS, ITS DIRECTORS, OFFICERS, EMPLOYEES OR AGENTS BE LIABLE FOR ANY INDIRECT, SPECIAL, INCIDENTAL, OR CONSEQUENTIAL DAMAGES (INCLUDING DAMAGES FOR LOSS OF PROFITS, LOSS OF BUSINESS, LOSS OF USE OR DATA, INTERRUPTION OF BUSINESS AND THE LIKE), EVEN IF ASUS HAS BEEN ADVISED OF THE POSSIBILITY OF SUCH DAMAGES ARISING FROM ANY DEFECT OR ERROR IN THIS MANUAL OR PRODUCT.

SPECIFICATIONS AND INFORMATION CONTAINED IN THIS MANUAL ARE FURNISHED FOR INFORMATIONAL USE ONLY, AND ARE SUBJECT TO CHANGE AT ANY TIME WITHOUT NOTICE, AND SHOULD NOT BE CONSTRUED AS A COMMITMENT BY ASUS. ASUS ASSUMES NO RESPONSIBILITY OR LIABILITY FOR ANY ERRORS OR INACCURACIES THAT MAY APPEAR IN THIS MANUAL, INCLUDING THE PRODUCTS AND SOFTWARE DESCRIBED IN IT.

Products and corporate names appearing in this manual may or may not be registered trademarks or copyrights of their respective companies, and are used only for identification or explanation and to the owners' benefit, without intent to infringe.

Contents

Notices	vi
Safety information	vii
About this guide	viii
Typography	ix
P5GD1 specifications summary	x

Chapter 1: Hardware information

1.1	Before you proceed	1-1
1.2	Motherboard overview	1-2
1.2.1	Placement direction	1-2
1.2.2	Screw holes	1-2
1.2.3	Motherboard layout	1-3
1.2.4	Layout contents	1-4
1.3	Central Processing Unit (CPU)	1-6
1.3.1	Installing the CPU	1-6
1.3.2	Installing the CPU heatsink and fan	1-9
1.3.3	Uninstalling the CPU heatsink and fan	1-11
1.4	System memory	1-13
1.4.1	Overview	1-13
1.4.2	Memory configurations	1-13
1.4.3	Installing a DIMM	1-16
1.4.4	Removing a DIMM	1-16
1.5	Expansion slots	1-17
1.5.1	Installing an expansion card	1-17
1.5.2	Configuring an expansion card	1-17
1.5.3	Interrupt assignments	1-18
1.5.4	PCI slots	1-19
1.5.5	PCI Express x16 slot	1-19
1.5.6	PCI Express x1 slot	1-19
1.6	Jumpers	1-20
1.7	Connectors	1-23
1.7.1	Rear panel connectors	1-23
1.7.2	Internal connectors	1-25

Contents

Chapter 2: BIOS setup

2.1	Managing and updating your BIOS	2-1
2.1.1	Creating a bootable floppy disk	2-1
2.1.2	ASUS EZ Flash utility	2-2
2.1.3	AFUDOS utility	2-3
2.2	BIOS setup program	2-5
2.2.1	BIOS menu screen	2-6
2.2.2	Menu bar	2-6
2.2.3	Navigation keys	2-6
2.2.4	Menu items	2-7
2.2.5	Sub-menu items	2-7
2.2.6	Configuration fields	2-7
2.2.7	Pop-up window	2-7
2.2.8	Scroll bar	2-7
2.2.9	General help	2-7
2.3	Main menu	2-8
2.3.1	System Time	2-8
2.3.2	System Date	2-8
2.3.3	Legacy Diskette A	2-8
2.3.4	Language	2-8
2.3.5	Primary, Third and Fourth IDE Master/Slave	2-9
2.3.6	IDE Configuration	2-10
2.3.7	System Information	2-11
2.4	Advanced menu	2-12
2.4.1	USB Configuration	2-12
2.4.2	CPU Configuration	2-13
2.4.3	Chipset	2-14
2.4.4	Onboard Devices Configuration	2-15
2.4.5	PCI PnP	2-16
2.5	Power menu	2-17
2.5.1	Suspend Mode	2-17
2.5.2	Repost Video on S3 Resume	2-17
2.5.3	ACPI 2.0 Support	2-17
2.5.4	ACPI APIC Support	2-17

Contents

2.5.5	APM Configuration	2-18
2.5.6	Hardware Monitor	2-19
2.6	Boot menu	2-21
2.6.1	Boot Device Priority	2-21
2.6.2	Boot Settings Configuration	2-22
2.6.3	Security	2-22
2.7	Exit menu	2-25

Notices

Federal Communications Commission Statement

This device complies with Part 15 of the FCC Rules. Operation is subject to the following two conditions:

- This device may not cause harmful interference, and
- This device must accept any interference received including interference that may cause undesired operation.

This equipment has been tested and found to comply with the limits for a Class B digital device, pursuant to Part 15 of the FCC Rules. These limits are designed to provide reasonable protection against harmful interference in a residential installation. This equipment generates, uses and can radiate radio frequency energy and, if not installed and used in accordance with manufacturer's instructions, may cause harmful interference to radio communications. However, there is no guarantee that interference will not occur in a particular installation. If this equipment does cause harmful interference to radio or television reception, which can be determined by turning the equipment off and on, the user is encouraged to try to correct the interference by one or more of the following measures:

- Reorient or relocate the receiving antenna.
- Increase the separation between the equipment and receiver.
- Connect the equipment to an outlet on a circuit different from that to which the receiver is connected.
- Consult the dealer or an experienced radio/TV technician for help.



The use of shielded cables for connection of the monitor to the graphics card is required to assure compliance with FCC regulations. Changes or modifications to this unit not expressly approved by the party responsible for compliance could void the user's authority to operate this equipment.

Canadian Department of Communications Statement

This digital apparatus does not exceed the Class B limits for radio noise emissions from digital apparatus set out in the Radio Interference Regulations of the Canadian Department of Communications.

This class B digital apparatus complies with Canadian ICES-003.

Safety information

Electrical safety

- To prevent electrical shock hazard, disconnect the power cable from the electrical outlet before relocating the system.
- When adding or removing devices to or from the system, ensure that the power cables for the devices are unplugged before the signal cables are connected. If possible, disconnect all power cables from the existing system before you add a device.
- Before connecting or removing signal cables from the motherboard, ensure that all power cables are unplugged.
- Seek professional assistance before using an adapter or extension cord. These devices could interrupt the grounding circuit.
- Make sure that your power supply is set to the correct voltage in your area. If you are not sure about the voltage of the electrical outlet you are using, contact your local power company.
- If the power supply is broken, do not try to fix it by yourself. Contact a qualified service technician or your retailer.

Operation safety

- Before installing the motherboard and adding devices on it, carefully read all the manuals that came with the package.
- Before using the product, make sure all cables are correctly connected and the power cables are not damaged. If you detect any damage, contact your dealer immediately.
- To avoid short circuits, keep paper clips, screws, and staples away from connectors, slots, sockets and circuitry.
- Avoid dust, humidity, and temperature extremes. Do not place the product in any area where it may become wet.
- Place the product on a stable surface.
- If you encounter technical problems with the product, contact a qualified service technician or your retailer.

About this guide

This user guide contains the information you need when installing and configuring the motherboard.

How this guide is organized

This manual contains the following parts:

- **Chapter 1: Hardware information**
This chapter lists the hardware setup procedures that you have to perform when installing system components. It includes description of the switches, jumpers, and connectors on the motherboard.
- **Chapter 2: BIOS setup**
This chapter tells how to change system settings through the BIOS Setup menus. Detailed descriptions of the BIOS parameters are also provided.

Where to find more information

Refer to the following sources for additional information and for product and software updates.

- **System builder website**
The system builder's provide updated information on the hardware and software products.
- **Optional documentation**
Your product package may include optional documentation, such as warranty flyers, that may have been added by your dealer. These documents are not part of the standard package.

Conventions used in this guide

To make sure that you perform certain tasks properly, take note of the following symbols used throughout this manual.



DANGER/WARNING: Information to prevent injury to yourself when trying to complete a task.



CAUTION: Information to prevent damage to the components when trying to complete a task.



IMPORTANT: Instructions that you **MUST** follow to complete a task.



NOTE: Tips and additional information to help you complete a task.

Typography

Bold text

Indicates a menu or an item to select

Italics

Used to emphasize a word or a phrase

<Key>

Keys enclosed in the less-than and greater-than sign means that you must press the enclosed key

Example: <Enter> means that you must press the Enter or Return key

<Key1+Key2+Key3>

If you must press two or more keys simultaneously, the key names are linked with a plus sign (+)

Example: <Ctrl+Alt+D>

Command

Means that you must type the command exactly as shown, then supply the required item or value enclosed in brackets

Example: At the DOS prompt, type the command line:

```
afudos /i[filename]
```

```
afudos /iP5GD1A.ROM
```

P5GD1 specifications summary

CPU	LGA775 socket for Intel® Pentium® 4/Celeron processor Compatible with the Intel® PCG 04A and 04B processors Supports Intel® Hyper-Threading Technology
Chipset	Northbridge: Intel® 915P Memory Controller Hub (MCH) Southbridge: Intel® ICH6
Front Side Bus	800/533 MHz
Memory	Dual-channel memory architecture 4 x 184-pin DIMM sockets support unbuffered non-ECC DDR 400 / DDR 333 memory modules
Expansion slots	1 x PCI Express x16 slot for discrete graphics card 3 x PCI Express x1 slots 3 x PCI slots
Storage	Intel® ICH6 Southbridge supports: <ul style="list-style-type: none"> - 2 x Ultra DMA 100/66/33 hard disk drives - 4 x Serial ATA hard disk drives
High Definition Audio	Intel® High Definition Audio Realtek® ALC861 8-channel CODEC with Jack-sensing and Universal Audio Jack (UAJ®) technology S/PDIF out interface support
LAN	Marvell® 88E8053 PCI Express™ Gigabit LAN controller
USB	Supports up to 8 USB 2.0 ports
IEEE 1394	TI TSB43AB22A supports <ul style="list-style-type: none"> - 2 x IEEE 1394a ports
Special features	ASUS Q-Fan ASUS Multi-language BIOS
BIOS features	4 Mb Flash ROM, AMI BIOS, PnP, DMI2.0, SM BIOS 2.3, WfM2.0

(continued on the next page)

P5GD1 specifications summary

Rear panel	<ul style="list-style-type: none">1 x PS/2 mouse port1 x Parallel port1 x IEEE 1394a port1 x LAN (RJ-45) port1 x Rear speaker out port1 x Side speaker out port1 x Line In port1 x Line Out port1 x Microphone port1 x Center/Subwoofer port4 x USB 2.0 ports1 x Serial port (COM)1 x Coaxial S/PDIF out port1 x Optical S/PDIF out port1 x PS/2 keyboard port
Internal connectors	<ul style="list-style-type: none">1 x CPU fan connector1 x Power fan connector1 x Chassis fan connector1 x 24-pin ATX power connector1 x 4-pin ATX 12 V power connector2 x USB 2.0 connectors for 4 additional USB 2.0 ports1 x Optical drive audio connector1 x Front panel audio connector1 x IEEE1394a connector1 x Chassis intrusion connectorIntel® Front panel connector
Power Requirement	<ul style="list-style-type: none">ATX power supply (with 24-pin and 4-pin 12 V plugs)ATX 12 V 2.0 compliant
Form Factor	ATX form factor: 12 in x 9.6 in (30.5 cm x 24.4 cm)

Specifications are subject to change without notice.

This chapter lists the hardware setup procedures that you have to perform when installing system components. It includes description of the jumpers and connectors on the motherboard.

Hardware information **1**

Chapter summary



1.1	Before you proceed	1-1
1.2	Motherboard overview	1-2
1.3	Central Processing Unit (CPU)	1-6
1.4	System memory	1-13
1.5	Expansion slots	1-17
1.6	Jumpers	1-20
1.7	Connectors	1-23

1.1 Before you proceed

Take note of the following precautions before you install motherboard components or change any motherboard settings.



- Unplug the power cord from the wall socket before touching any component.
- Use a grounded wrist strap or touch a safely grounded object or to a metal object, such as the power supply case, before handling components to avoid damaging them due to static electricity
- Hold components by the edges to avoid touching the ICs on them.
- Whenever you uninstall any component, place it on a grounded antistatic pad or in the bag that came with the component.
- **Before you install or remove any component, ensure that the ATX power supply is switched off or the power cord is detached from the power supply.** Failure to do so may cause severe damage to the motherboard, peripherals, and/or components.

Onboard LED

The motherboard comes with a standby power LED that lights up to indicate that the system is ON, in sleep mode, or in soft-off mode. This is a reminder that you should shut down the system and unplug the power cable before removing or plugging in any motherboard component. The illustration below shows the location of the onboard LED.

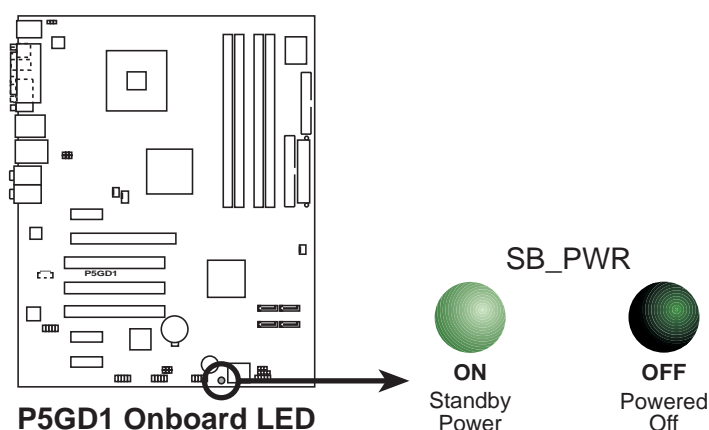

1.2 Motherboard overview

Before you install the motherboard, study the configuration of your chassis to ensure that the motherboard fits into it. Refer to the chassis documentation before installing the motherboard.



Make sure to unplug the power cord before installing or removing the motherboard. Failure to do so can cause you physical injury and damage motherboard components.

1.2.1 Placement direction

When installing the motherboard, make sure that you place it into the chassis in the correct orientation. The edge with external ports goes to the rear part of the chassis as indicated in the image below.

1.2.2 Screw holes

Place nine (9) screws into the holes indicated by circles to secure the motherboard to the chassis.



Do not overtighten the screws! Doing so can damage the motherboard.

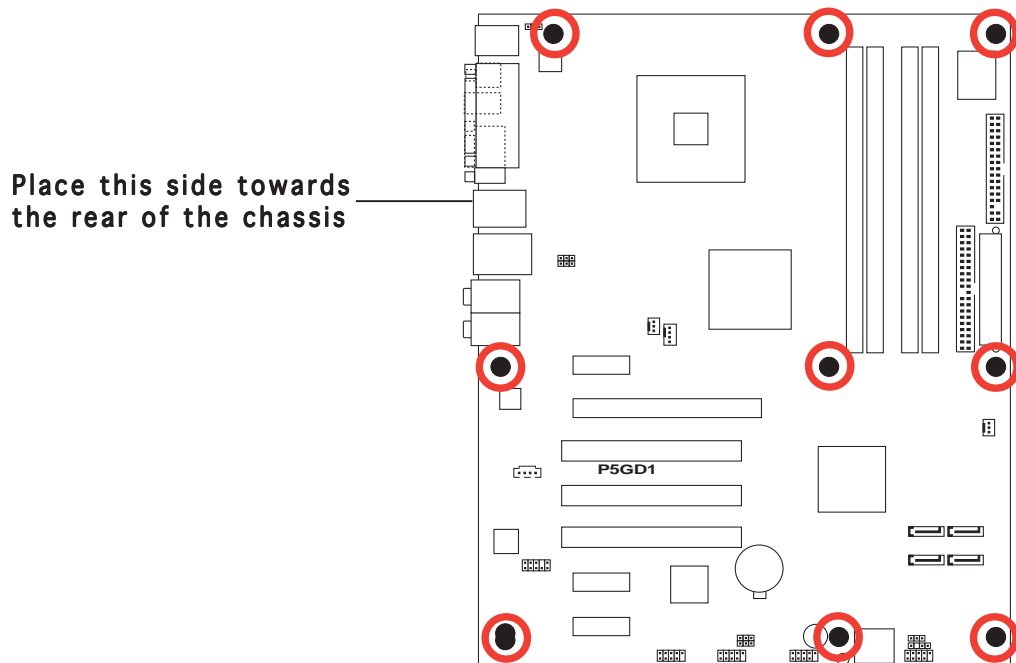

1.2.3 Motherboard layout

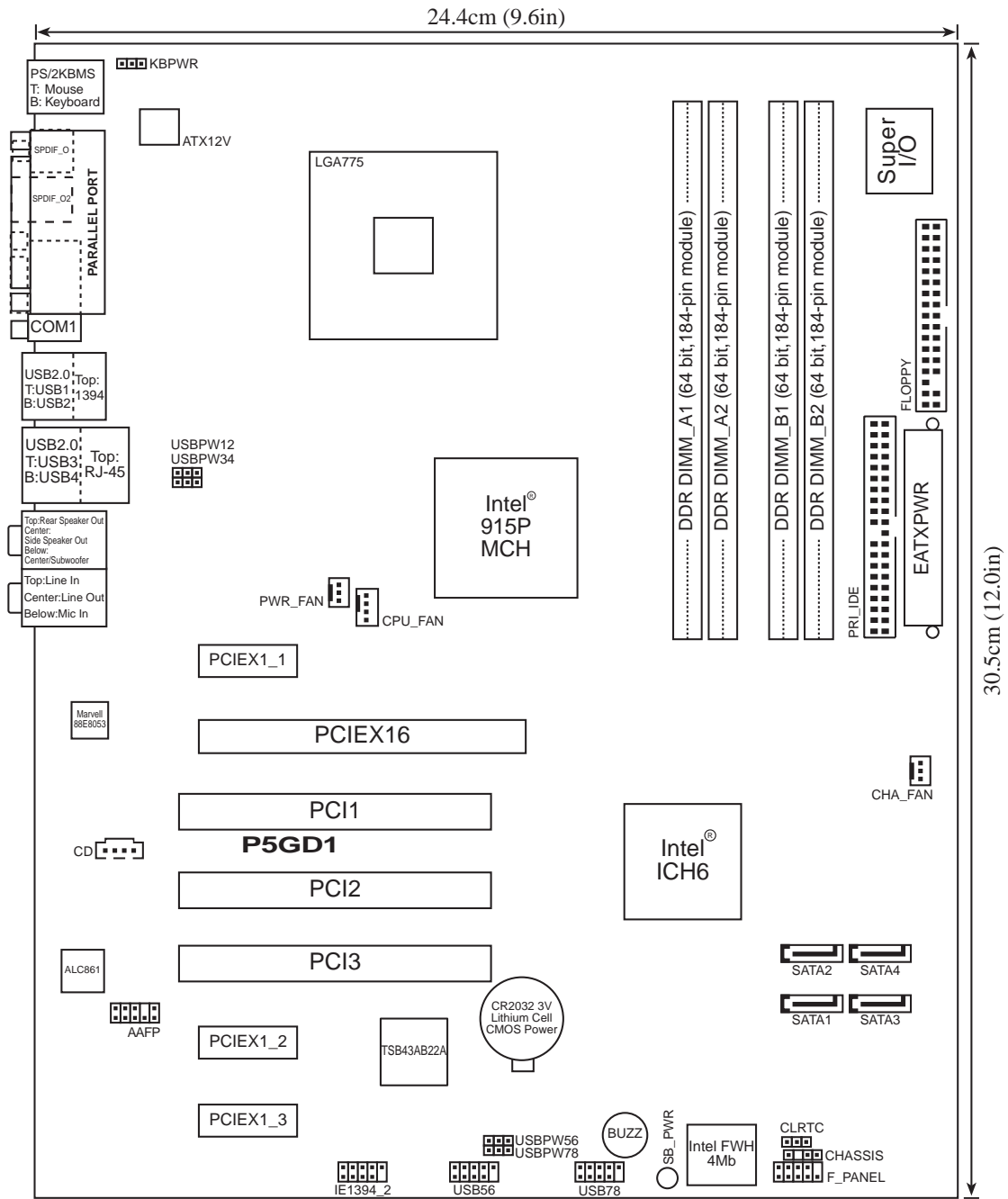

1.2.4 Layout contents

Slots	Page
1. DDR DIMM slots	1-13
2. PCI slots	1-19
3. PCI Express slots	1-19

Jumpers	Page
1. Clear RTC RAM (3-pin CLRTC1)	1-20
2. USB device wake-up (3-pin USBPW12, USBPW34, USBPW56, USBPW78)	1-21
3. Keyboard power (3-pin KBPWR)	1-22

Rear panel connectors	Page
1. PS/2 mouse port	1-23
2. Parallel port	1-23
3. IEEE 1394a port	1-23
4. RJ-45 port	1-23
5. Rear Speaker Out port	1-23
6. Side Speaker Out port	1-23
7. Line In port	1-23
8. Line Out port	1-23
9. Microphone port	1-24
10. Center/Subwoofer port	1-24
11. USB 2.0 ports 3 and 4	1-24
12. USB 2.0 ports 1 and 2	1-24
13. Serial connector	1-24
14. Optical S/PDIF out port	1-24
15. Coaxial S/PDIF out port	1-24
16. PS/2 keyboard port	1-24

Internal connectors	Page
1. Floppy disk drive connector (34-1 pin FLOPPY)	1-25
2. Primary IDE connector (40-1 pin PRI_IDE)	1-25
3. Serial ATA connectors (7-pin SATA1, SATA2, SATA3, SATA4)	1-26
4. CPU fan connector (4-pin CPU_FAN)	1-27
5. Power fan connector (3-pin PWR_FAN)	1-27
6. Chassis fan connector (3-pin CHA_FAN)	1-27
7. USB connectors (10-1 USB56, USB78)	1-27
8. ATX power connector (24-pin EATXPWR)	1-28
9. ATX 12V power connector (4-pin ATX12V)	1-28
10. Optical drive audio connector (4-pin CD)	1-29
11. Front panel audio connector (10-1 pin AAFP)	1-29
12. Chassis intrusion connector (4-1 pin CHASSIS)	1-30
13. IEEE1394a connector (10-1 pin IE1394_2)	1-30
14. System panel connector (10-1 pin F_PANEL)	1-31
- System Power LED (2-pin PLED)	
- Power/Soft-off button(2-pin PWRSW)	
- Reset switch (2-pin RESET)	
- Hard disk activity (2-pin IDE_LED)	

1.3 Central Processing Unit (CPU)

The motherboard comes with a surface mount LGA775 socket designed for the Intel® Pentium® 4 processor in the 775-land package.



- Your boxed Intel® Pentium® 4 LGA775 processor package should come with installation instructions for the CPU, fan and heatsink assembly. If the instructions in this section do not match the CPU documentation, follow the latter.
- Upon purchase of the motherboard, make sure that the PnP cap is on the socket and the socket pins are not bent. Contact your retailer immediately if the PnP cap is missing, or if you see any damage to the PnP cap/socket pins/motherboard components. ASUS will shoulder the cost of repair only if the damage is shipment/transit-related.
- Keep the cap after installing the motherboard. ASUS will process Return Merchandise Authorization (RMA) requests only if the motherboard comes with the cap on the LGA775 socket.
- The product warranty does not cover damage to the socket pins resulting from incorrect CPU installation/removal, or misplacement/loss/incorrect removal of the PnP cap.

1.3.1 Installing the CPU

To install a CPU:

1. Locate the CPU socket on the motherboard.

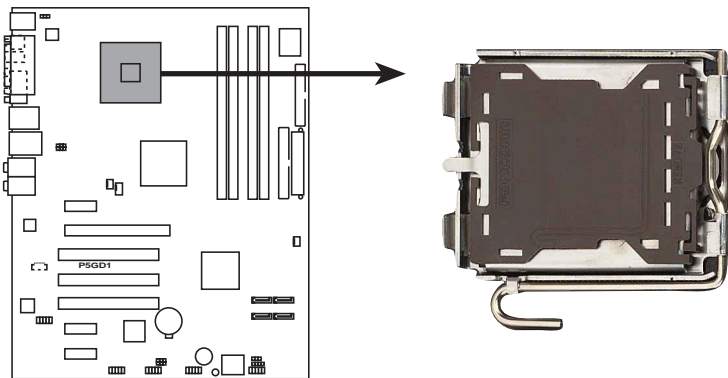

P5GD1 CPU Socket 775



Before installing the CPU, make sure that the socket box is facing towards you and the load lever is on your left.

2. Press the load lever with your thumb (A) and move it to the left (B) until it is released from the retention tab.

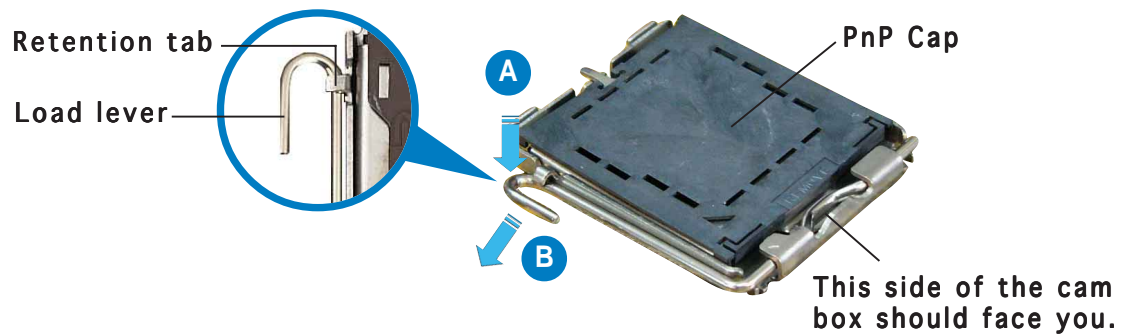

To prevent damage to the socket pins, do not remove the PnP cap unless you are installing a CPU.

3. Lift the load lever in the direction of the arrow to a 135° angle.

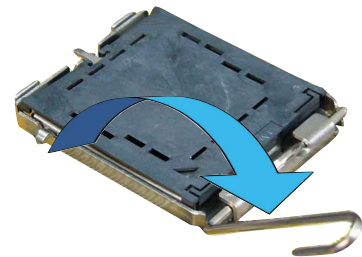

4. Lift the load plate with your thumb and forefinger to a 100° angle (A), then push the PnP cap from the load plate window to remove (B).

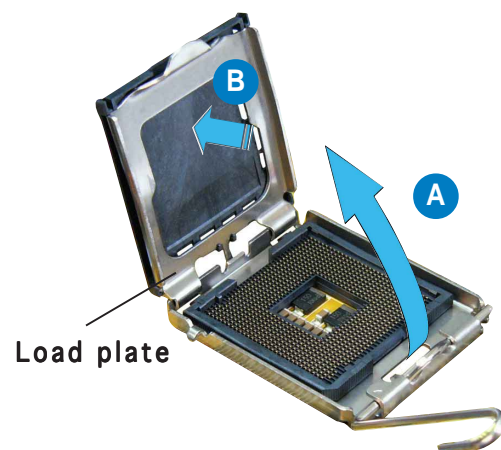

5. Position the CPU over the socket, making sure that the gold triangle is on the bottom-left corner of the socket. The socket alignment key should fit into the CPU notch.

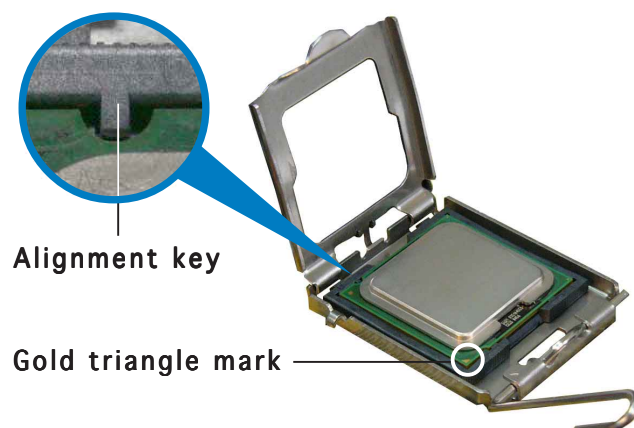

6. Close the load plate (A), then push the load lever (B) until it snaps into the retention tab.

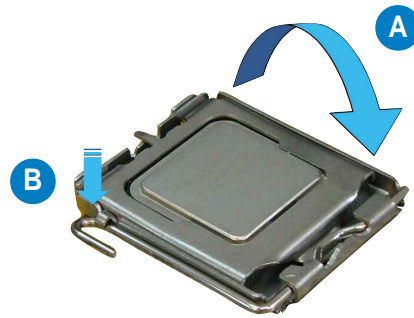

The CPU fits in only one correct orientation. DO NOT force the CPU into the socket to prevent bending the connectors on the socket and damaging the CPU!

Notes on Intel® Hyper-Threading Technology



- This motherboard supports Intel® Pentium® 4 CPUs in the 775-land package with Hyper-Threading Technology.
 - Hyper-Threading Technology is supported under Windows® XP/2003 Server and Linux 1.4.x (kernel) and later versions only. Under Linux, use the Hyper-Threading compiler to compile the code. If you are using any other operating systems, disable the Hyper-Threading Technology item in the BIOS to ensure system stability and performance.
 - Installing Windows® XP Service Pack 1 is recommended.
 - Make sure to enable the Hyper-Threading Technology item in BIOS before installing a supported operating system.
 - For more information on Hyper-Threading Technology, visit www.intel.com/info/hyperthreading.
-

To use the Hyper-Threading Technology on this motherboard:

1. Install an Intel® Pentium® 4 CPU that supports Hyper-Threading Technology.
2. Power up the system and enter the BIOS Setup (see Chapter 4: BIOS setup). Under the Advanced Menu, make sure that the item Hyper-Threading Technology is set to Enabled. The item appears only if you installed a CPU that supports Hyper-Threading Technology.
3. Reboot the computer.

1.3.2 Installing the CPU heatsink and fan

The Intel® Pentium® 4 LGA775 processor requires a specially designed heatsink and fan assembly to ensure optimum thermal condition and performance.



- When you buy a boxed Intel® Pentium® 4 processor, the package includes the CPU fan and heatsink assembly. If you buy a CPU separately, make sure that you use only Intel®-certified multi-directional heatsink and fan.
- Your Intel® Pentium® 4 LGA775 heatsink and fan assembly comes in a push-pin design and requires no tool to install.
- If you purchased a separate CPU heatsink and fan assembly, make sure that you have properly applied Thermal Interface Material to the CPU heatsink or CPU before you install the heatsink and fan assembly.



Make sure that you have installed the motherboard to the chassis before you install the CPU fan and heatsink assembly.

To install the CPU heatsink and fan:

1. Place the heatsink on top of the installed CPU, making sure that the four fasteners match the holes on the motherboard.



Orient the heatsink and fan assembly such that the CPU fan cable is closest to the CPU fan connector.

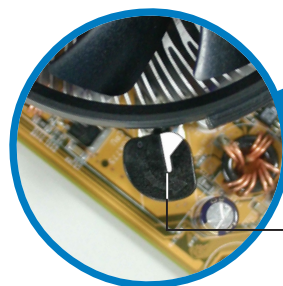

Narrow end
of the groove

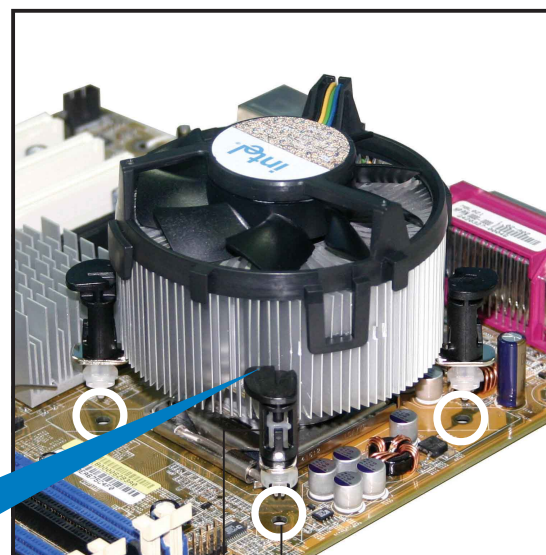

Motherboard hole
Fastener



Make sure to orient each fastener with the narrow end of the groove pointing outward. (The photo shows the groove shaded for emphasis.)

2. Push down two fasteners at a time in a diagonal sequence to secure the heatsink and fan assembly in place.

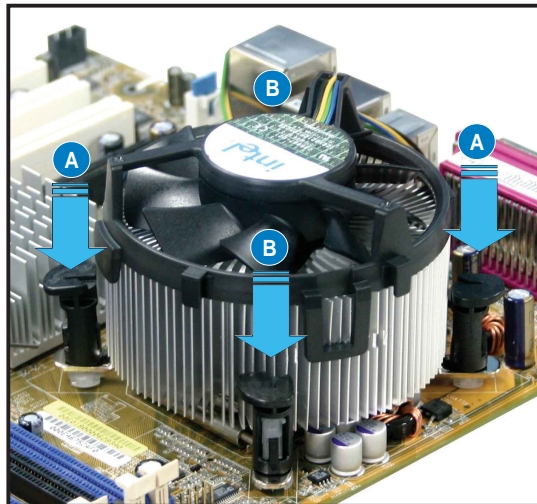
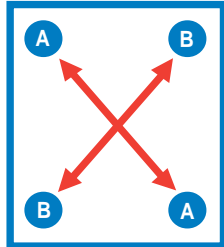

3. Connect the CPU fan cable to the connector on the motherboard labeled CPU_FAN.

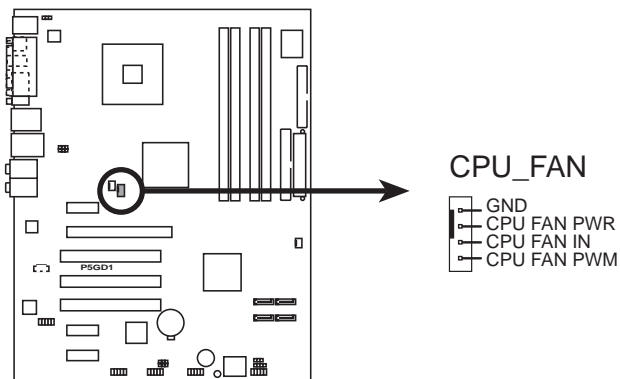

P5GD1 CPU_Fan connector



Do not forget to connect the CPU fan connector! Hardware monitoring errors can occur if you fail to plug this connector.

1.3.3 Uninstalling the CPU heatsink and fan

To uninstall the CPU heatsink and fan:

1. Disconnect the CPU fan cable from the connector on the motherboard.
2. Rotate each fastener counterclockwise.

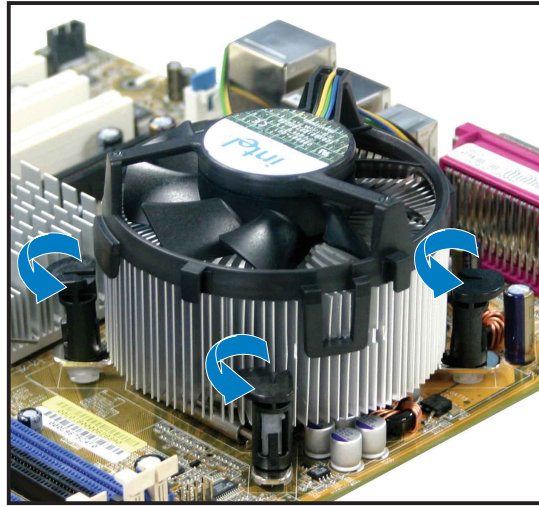

3. Pull up two fasteners at a time in a diagonal sequence to disengage the heatsink and fan assembly from the motherboard.

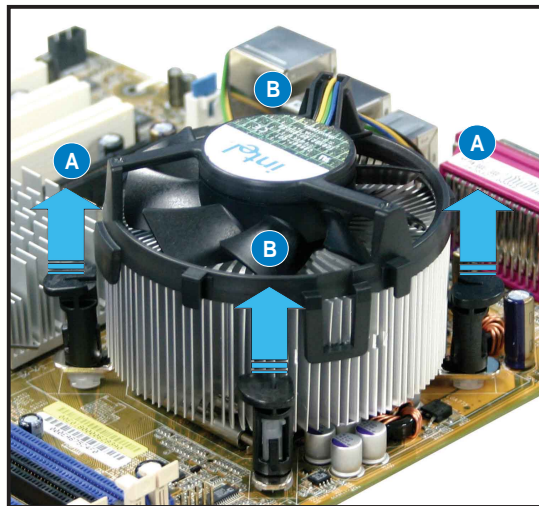
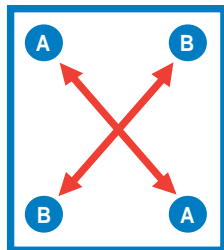

- Carefully remove the heatsink and fan assembly from the motherboard.

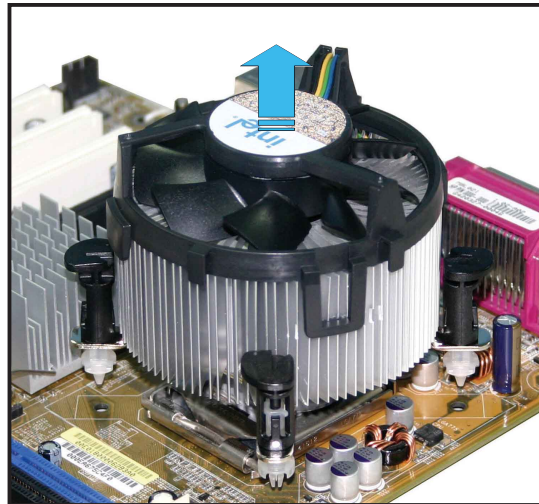

- Rotate each fastener clockwise to ensure correct orientation when reinstalling.

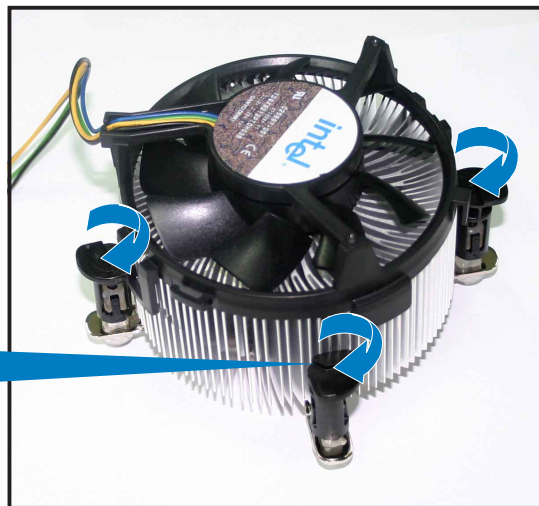
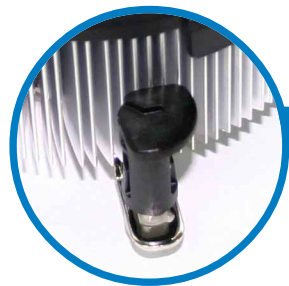

Narrow end of the groove



The narrow end of the groove should point outward after resetting. (The photo shows the groove shaded for emphasis.)



1.4 System memory

1.4.1 Overview

The motherboard comes with four 184-pin Double Data Rate (DDR) Dual Inline Memory Modules (DIMM) sockets.

The following figure illustrates the location of the sockets:

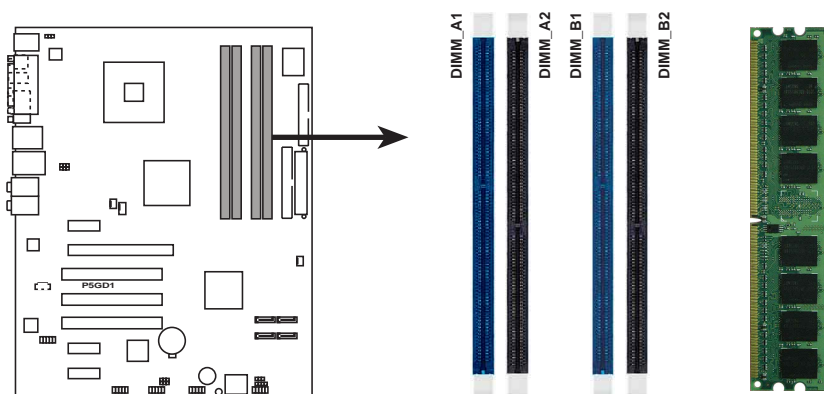

P5GD1 184-pin DDR DIMM sockets

1.4.2 Memory configurations

You may install 256 MB, 512 MB and 1 GB unbuffered non-ECC DDR DIMMs into the DIMM sockets using the memory configurations in this section.



- Installing DDR DIMMs other than the recommended configurations may cause memory sizing error or system boot failure. Use any of the recommended configurations in Table 1.
- In dual-channel configurations, install only **identical** (the same type and size) DDR DIMM pairs for each channel.
- Always install DIMMs with the same CAS latency. For optimum compatibility, it is recommended that you obtain memory modules from the same vendor.
- Double-sided x16 modules are not supported in this motherboard.
- Due to chipset resource allocation, the system may detect less than 4 GB system memory when you installed four 1 GB DDR memory modules.
- Due to chipset limitation, DIMM modules with 128 Mb memory chips or double-sided x16 memory chips are not supported in this motherboard.

Recommended memory configurations

Mode	Sockets			
	DIMM_A1 (blue)	DIMM_A2 (black)	DIMM_B1 (blue)	DIMM_B2 (black)
Single-channel	(1) Populated	—	—	—
	(2) —	Populated	—	—
	(3) —	—	Populated	—
	(4) —	—	—	Populated
Dual-channel	(1) Populated	—	Populated	—
	(2) —	Populated	—	Populated
	(3) *Populated	Populated	Populated	Populated

* For dual-channel configuration (3), you may:

- install identical DIMMs in all four sockets
- install identical DIMM pair in DIMM_A1 and DIMM_B1 (blue sockets) and identical DIMM pair in DIMM_A2 and DIMM_B2 (black sockets)
- install same size DIMMs in DIMM_A1 and DIMM_B1 (blue sockets) and another same size pair in DIMM_A2 and DIMM_B2 (black sockets)

DDR400 Qualified Vendors List

Size	Vendor	Model	Brand	Side(s)	Component	DIMM support		
						A	B	C
256MB	KINGSTON	KVR400X64C3A/256	Hynix	SS	HY5DU56822BT-D43	•	•	
512MB	KINGSTON	KVR400X64C3A/512	Hynix	DS	HY5DU56822BT-D43	•	•	
256MB	KINGSTON	KVR400X64C3A/256	Infineon	SS	HYB25D256800BT-5B	•	•	•
512MB	KINGSTON	KVR400X64C3A/512	Infineon	DS	HYB25D256809BT-5B	•		
256MB	KINGSTON	KVR400X64C3A/256	KINGSTON	SS	D3208DL2T-5	•	•	
512MB	KINGSTON	KVR400X64C3A/512	KINGSTON	DS	D328DIB-50	•	•	•
512MB	KINGSTON	KHX3200A/512	N/A	DS	Heat-Sink Package	•	•	
256MB	SAMSUNG	M368L3223ETM-CCC	SAMSUNG	SS	K4H560838E-TCCC	•	•	•
512MB	SAMSUNG	M368L6423ETM-CCC	SAMSUNG	DS	K4H560838E-TCCC	•		
256MB	SAMSUNG	M368L3223FTN-CCC	SAMSUNG	SS	K4H560838F-TCCC	•	•	
512MB	SAMSUNG	M368L6423FTN-CCC	SAMSUNG	DS	K4H560838F-TCCC	•	•	
256MB	Hynix	HYMD232646B8J-D43 AA	Hynix	SS	HY5DU56822BT-D43	•	•	
512MB	Hynix	HYMD264646B8J-D43 AA	Hynix	DS	HY5DU56822BT-D43	•		
256MB	MICRON	MT8VDDT3264AG-40BCB	MICRON	SS	MT46V32M8TG-5BC	•	•	•
512MB	MICRON	MT16VDDT6464AG-40BCB	MICRON	DS	MT46V32M8TG-5BC	•	•	•
256MB	Infineon	HYS64D32300GU-5-B	Infineon	SS	HYB25D256800BT-5B	•	•	
512MB	Infineon	HYS64D64320GU-5-B	Infineon	DS	HYB25D256800BT-5B	•	•	
256MB	Infineon	HYS64D32300HU-5-C	Infineon	SS	HYB25D256800CE-5C	•	•	•
512MB	Infineon	HYS64D64320HU-5-C	Infineon	DS	HYB25D256800CE-5C	•	•	
256MB	CORSAIR	CMX256A-3200C2PT	Winbond	SS	W942508BH-5	•	•	•
512MB	CORSAIR	CMX512-3200C2	Winbond	DS	Heat-Sink Package	•	•	
512MB	CORSAIR	VS512MB400	VALUE seLecT	DS	VS32M8-5	•	•	

(continued on the next page)

DDR400 Qualified Vendors List

Size	Vendor	Model	Brand	Side(s)	Component	DIMM support		
						A	B	C
256MB	GEIL	GE2563200B	GEIL	SS	GL3LC32G88TG-5A	•	•	
512MB	GEIL	GE5123200B	GEIL	DS	GL3LC32G88TG-5A	•	•	
256MB	GEIL	GD3200-256V	GEIL	SS	GLIL DDR 32M8	•	•	
512MB	GEIL	GD3200-512V	GEIL	DS	GLIL DDR 32M8	•	•	•
256MB	TwinMOS	M2S9I08AFAPS9F0811A-T	PSC	SS	A2S56D30ATP	•	•	•
256MB	TwinMOS	M2G9I08AIATT9F081AADT	TwinMOS	SS	TMD7608F8E50D	•	•	•
512MB	TwinMOS	M2G9J16AJATT9F081AADT	TwinMOS	DS	TMD7608F8E50D	•	•	
256MB	Transcend	TS32MLD64V4F3	N/A	SS	K4H560838F-TCCC	•	•	•
512MB	Transcend	TS64MLD64V4F3	N/A	DS	K4H560838F-TCCC	•	•	•
1024MB	Transcend	TS128MLD64V4J	N/A	DS	K4H510838B-TCCC	•	•	•
256MB	Transcend	TS32MLD64V4F3	Mosel	SS	V58C2256804SAT5B	•	•	•
512MB	Transcend	TS64MLD64V4F3	Mosel	DS	V58C2256804SAT5B	•	•	•
256MB	Transcend	TS32MLD64V4F3	SAMSUNG	SS	K4H560838E-TCCC	•	•	
512MB	Transcend	TS64MLD64V4F3	SAMSUNG	DS	K4H560838E-TCCC	•	•	•
256MB	A DATA	MDOSS6F3G31Y0K1E0Z	SAMSUNG	SS	K4H560838E-TCCC	•	•	
512MB	A DATA	MDOSS6F3H41Y0N1E0Z	SAMSUNG	DS	K4H560838F-TCCC	•	•	•
256MB	A DATA	MDOHY6F3G31Y0N1E0Z	Hynix	SS	HY5DU56822CT-D43	•	•	•
512MB	A DATA	MDOHY6F3H41Y0N1E0Z	Hynix	DS	HY5DU56822CT-D43	•	•	•
256MB	A DATA	MDOAD5F3G31Y0D1E02	N/A	SS	ADD8608A8A-5B	•	•	•
512MB	A DATA	MDOAD5F3H41Y0D1E02	N/A	DS	ADD8608A8A-5B	•	•	•
256MB	Winbond	W9425GCDB-5	Winbond	SS	W942508CH-5	•	•	
512MB	Winbond	W9451GCDB-5	Winbond	DS	W942508CH-5	•	•	
512MB	PSC	AL6D8A53T1-5B	PSC	DS	A2S56D30ATP	•	•	
256MB	PSC	AL5D8B53T-5B1K	PSC	SS	A2S56D30BTP	•	•	
512MB	PSC	AL6D8B53T-5B1K	PSC	DS	A2S56D30BTP	•	•	•
256MB	KINGMAX	MPXB62D-38KT3R	N/A	SS	KDL388P4LA-50	•	•	•
512MB	KINGMAX	MPXC22D-38KT3R	N/A	DS	KDL388P4LA-50	•	•	•
512MB	ATP	AG64L64T8SQC4S	SAMSUNG	DS	K4H560838D-TCC4	•		
1024MB	ATP	AG28L64T8SMC4M	MICRON	DS	MT46V64M4TG-5BC	•	•	
256MB	NANYA	NT256D64S88B1G-5T	NANYA	SS	NT5DS32M8BT-5T	•	•	•
512MB	NANYA	N512D64S8HB1G-5T	NANYA	DS	NT5DS32M8BT-5T	•	•	•
256MB	BRAIN POWER	B6U808-256M-SAM-400	SAMSUNG	SS	K4H560838D-TCC4	•	•	
512MB	BRAIN POWER	B6U808-512M-SAM-400	SAMSUNG	DS	K4H560838D-TCC4	•	•	
256MB	CENTURY	DXV6S8SSCCD3K27C	SAMSUNG	SS	K4H560838D-TCCC	•	•	•
512MB	CENTURY	DXV2S8SSCCD3K27C	SAMSUNG	DS	K4H560838D-TCCC	•	•	•
256MB	CENTURY	DXV6S8SSCCE3K27E	SAMSUNG	SS	K4H560838E-TCCC	•	•	
512MB	CENTURY	DXV2S8SSCCE3K27E	SAMSUNG	DS	K4H560838E-TCCC	•	•	•
256MB	CENTURY	DXV6S8MC5BC3U27E	MICRON	SS	MT46V32M8TG-5BC	•	•	•
512MB	CENTURY	DXV2S8MC5BC3U27E	MICRON	DS	MT46V32M8TG-5BC	•	•	•
256MB	elixir	M2U25664DS88B3G-5T	NANYA	SS	N2DS25680BT-5T	•	•	
512MB	elixir	M2U25664DS8HB3G-5T	NANYA	DS	N2DS25680BT-5T	•		•
256MB	Kreton	N/A	VT	SS	VT3225804T-5	•	•	•
512MB	Kreton	N/A	VT	DS	VT3225804T-5	•	•	
256MB	Veritech	VT400FMV/2561103	VT	SS	VT56DD32M8PC-5	•	•	•
512MB	Veritech	VT400FMV/5121003	VT	DS	VT56DD32M8PC-5	•	•	
256MB	Pmi	MD44256VIT3208GMHA01	MOSEL	SS	V58C2256804SAT5B	•	•	•
512MB	Pmi	MD44512VIT3208GATA03	MOSEL	DS	V58C2256804SAT5B	•	•	

Legend:

- A** - supports one module inserted into either slot, in a Single-channel memory configuration.
- B** - supports on pair of modules inserted into either the blue slots or the black slots as one pair of Dual-channel memory configuration.
- C** - support for 4 modules inserted into the blue and black slots as two pairs of Dual-channel memory configuration.
- SS** - Single-sided
- DS** - Double-sided

1.4.3 Installing a DIMM



Make sure to unplug the power supply before adding or removing DIMMs or other system components. Failure to do so may cause severe damage to both the motherboard and the components.

1. Unlock a DIMM socket by pressing the retaining clips outward.
2. Align a DIMM on the socket such that the notch on the DIMM matches the break on the socket.

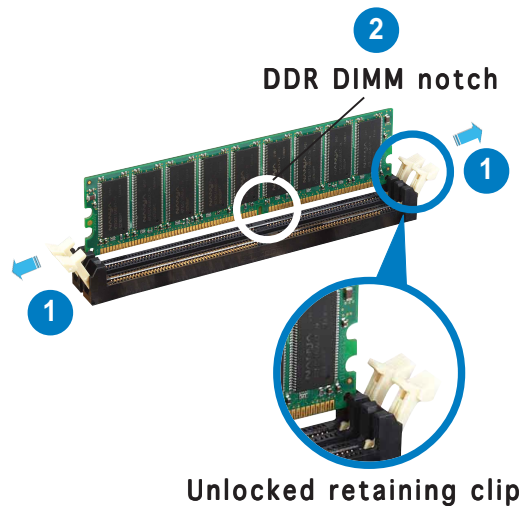

A DDR DIMM is keyed with a notch so that it fits in only one direction. **DO NOT** force a DIMM into a socket to avoid damaging the DIMM.

3. Firmly insert the DIMM into the socket until the retaining clips snap back in place and the DIMM is properly seated.

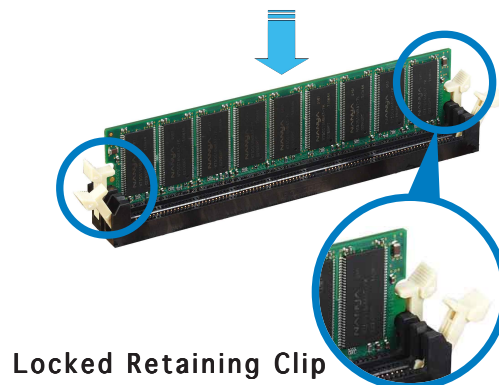

1.4.4 Removing a DIMM

Follow these steps to remove a DIMM.

1. Simultaneously press the retaining clips outward to unlock the DIMM.

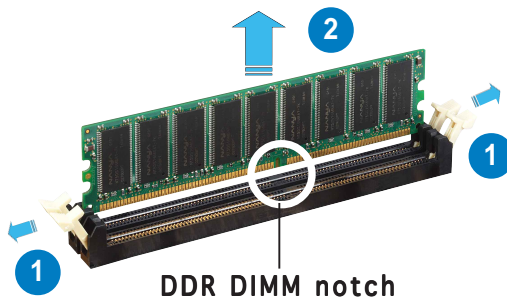

Support the DIMM lightly with your fingers when pressing the retaining clips. The DIMM might get damaged when it flips out with extra force.

2. Remove the DIMM from the socket.

1.5 Expansion slots

In the future, you may need to install expansion cards. The following sub-sections describe the slots and the expansion cards that they support.



Make sure to unplug the power cord before adding or removing expansion cards. Failure to do so may cause you physical injury and damage motherboard components.

1.5.1 Installing an expansion card

To install an expansion card:

1. Before installing the expansion card, read the documentation that came with it and make the necessary hardware settings for the card.
2. Remove the system unit cover (if your motherboard is already installed in a chassis).
3. Remove the bracket opposite the slot that you intend to use. Keep the screw for later use.
4. Align the card connector with the slot and press firmly until the card is completely seated on the slot.
5. Secure the card to the chassis with the screw you removed earlier.
6. Replace the system cover.

1.5.2 Configuring an expansion card

After installing the expansion card, configure it by adjusting the software settings.

1. Turn on the system and change the necessary BIOS settings, if any. See Chapter 2 for information on BIOS setup.
2. Assign an IRQ to the card. Refer to the tables on the next page.
3. Install the software drivers for the expansion card.

1.5.3 Interrupt assignments

Standard interrupt assignments

IRQ	Priority	Standard Function
0	1	System Timer
1	2	Keyboard Controller
2	—	Re-direct to IRQ#9
3	11	Communications Port (COM2)*
4	12	Communications Port (COM1)*
5	13	IRQ holder for PCI steering*
6	14	Floppy Disk Controller
7	15	Printer Port (LPT1)*
8	3	System CMOS/Real Time Clock
9	4	IRQ holder for PCI steering*
10	5	IRQ holder for PCI steering*
11	6	IRQ holder for PCI steering*
12	7	PS/2 Compatible Mouse Port*
13	8	Numeric Data Processor
14	9	Primary IDE Channel
15	10	Secondary IDE Channel

* These IRQs are usually available for ISA or PCI devices.

IRQ assignments for this motherboard

	A	B	C	D	E	F	G	H
PCI slot 1	—	—	—	—	—	—	used	—
PCI slot 2	—	shared	—	—	—	—	—	—
PCI slot 3	—	—	—	—	—	used	—	—
PCI E x1 slot 1	shared	—	—	—	—	—	—	—
PCI E x1 slot 2	—	—	shared	—	—	—	—	—
PCI E x1 slot 3	—	—	—	shared	—	—	—	—
PCI E x16 slot	shared	—	—	—	—	—	—	—
Onboard USB controller 1	—	—	—	—	—	—	—	shared
Onboard USB controller 2	—	—	—	shared	—	—	—	—
Onboard USB controller 3	—	—	shared	—	—	—	—	—
Onboard USB controller 4	shared	—	—	—	—	—	—	—
Onboard USB 2.0 controller	—	—	—	—	—	—	—	shared
Onboard LAN	—	shared	—	—	—	—	—	—
Onboard Azalia audio	shared	—	—	—	—	—	—	—



When using PCI cards on shared slots, ensure that the drivers support “Share IRQ” or that the cards do not need IRQ assignments; otherwise, conflicts will arise between the two PCI groups, making the system unstable and the card inoperable.

1.5.4 PCI slots

The PCI slots support cards such as a LAN card, SCSI card, USB card, and other cards that comply with PCI specifications. The figure shows a LAN card installed on a PCI slot.

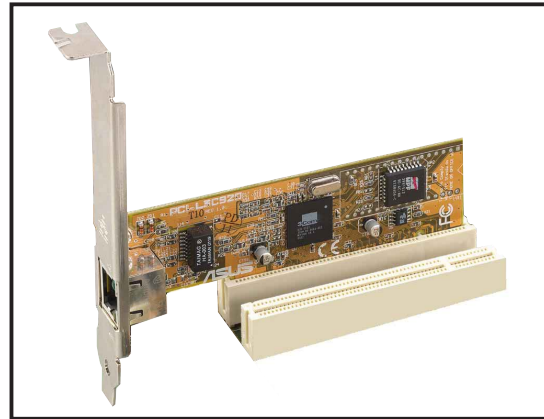

1.5.5 PCI Express x16 slot

This motherboard supports PCI Express x16 graphic cards that comply with the PCI Express specifications. The figure shows a graphics card installed on the PCI Express x16 slot.

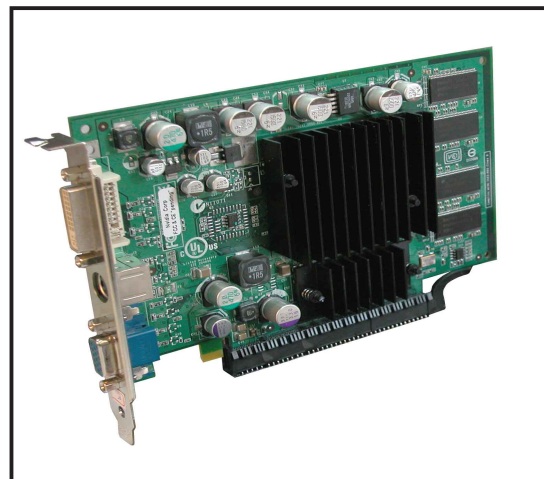

1.5.6 PCI Express x1 slot

This motherboard supports PCI Express x1 network cards, SCSI cards and other cards that comply with the PCI Express specifications. The figure shows a network card installed on the PCI Express x1 slot.

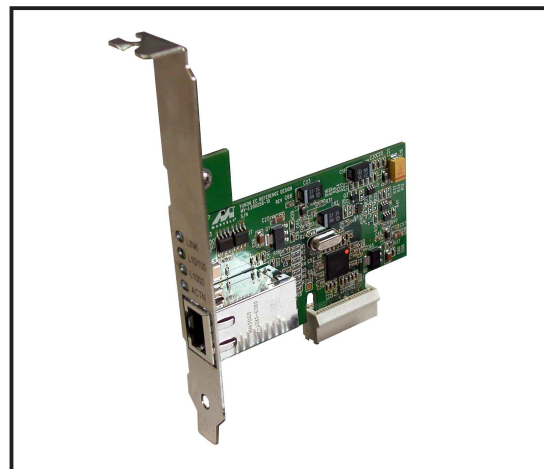

1.6 Jumpers

1. Clear RTC RAM (CLRTC)

This jumper allows you to clear the Real Time Clock (RTC) RAM in CMOS. You can clear the CMOS memory of date, time, and system setup parameters by erasing the CMOS RTC RAM data. The onboard button cell battery powers the RAM data in CMOS, which include system setup information such as system passwords.

To erase the RTC RAM:

1. Turn OFF the computer and unplug the power cord.
2. Remove the onboard battery.
3. Move the jumper cap from pins 1-2 (default) to pins 2-3. Keep the cap on pins 2-3 for about 5~10 seconds, then move the cap back to pins 1-2.
4. Re-install the battery.
5. Plug the power cord and turn ON the computer.
6. Hold down the key during the boot process and enter BIOS setup to re-enter data.



Except when clearing the RTC RAM, never remove the cap on CLRTC jumper default position. Removing the cap will cause system boot failure!

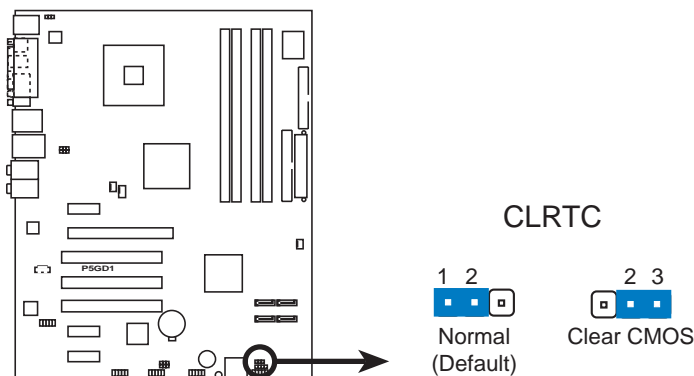

P5GD1 Clear RTC RAM Setting



You do not need to clear the RTC when the system hangs due to overclocking. For system failure due to overclocking, use the C.P.R. (CPU Parameter Recall) feature. Shut down and reboot the system so the BIOS can automatically reset parameter settings to default values.

2. USB device wake-up (3-pin USBPW12, USBPW34, USBPW56, USBPW78)

Set these jumpers to +5V to wake up the computer from S1 sleep mode (CPU stopped, DRAM refreshed, system running in low power mode) using the connected USB devices. Set to +5VSB to wake up from S3 and S4 sleep modes (no power to CPU, DRAM in slow refresh, power supply in reduced power mode).

The USBPW12 and USBPW34 jumpers are for the rear USB ports. The USBPW56 and USBPW78 jumper is for the internal USB connectors that you can connect to additional USB ports.

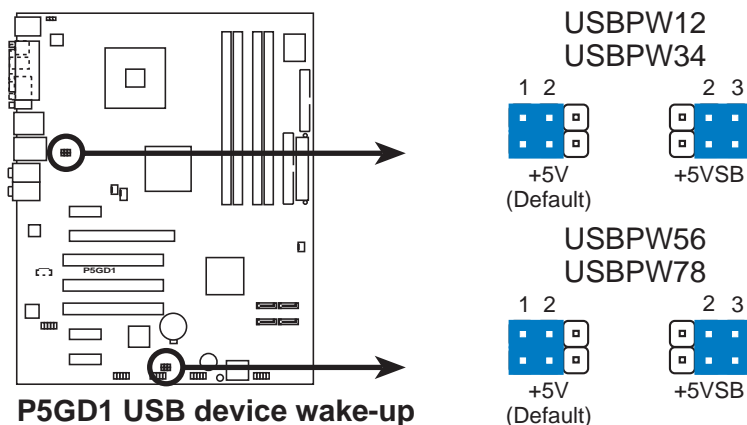

- The USB device wake-up feature requires a power supply that can provide 500mA on the +5VSB lead for each USB port; otherwise, the system would not power up.
- The total current consumed must NOT exceed the power supply capability (+5VSB) whether under normal condition or in sleep mode.

3. Keyboard power (3-pin KBPWR)

This jumper allows you to enable or disable the keyboard wake-up feature. Set this jumper to pins 2-3 (+5VSB) if you wish to wake up the computer when you press a key on the keyboard (the default is the Space Bar). This feature requires an ATX power supply that can supply at least 1A on the +5VSB lead, and a corresponding setting in the BIOS.

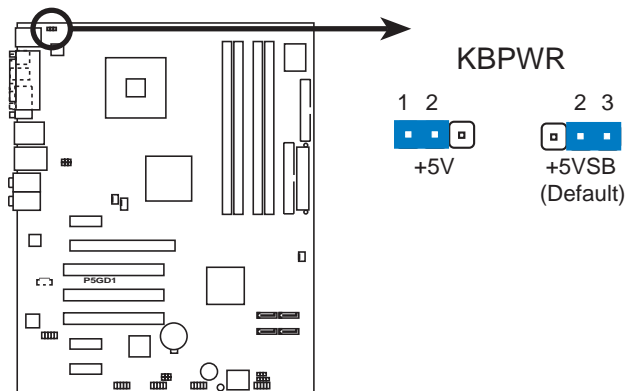

P5GD1 Keyboard power setting

1.7 Connectors

1.7.1 Rear panel connectors

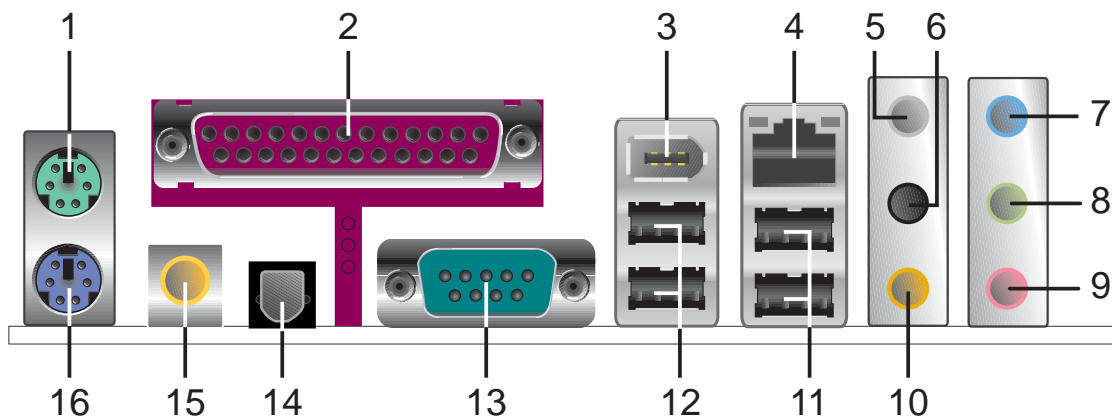

1. **PS/2 mouse port (green).** This port is for a PS/2 mouse.
2. **Parallel port.** This 25-pin port connects a parallel printer, a scanner, or other devices.
3. **IEEE 1394a port.** This 6-pin IEEE 1394a port provides high-speed connectivity for audio/video devices, storage peripherals, PCs, or other portable devices.
4. **LAN (RJ-45) port.** This port allows Gigabit connection to a Local Area Network (LAN) through a network hub. Refer to the table below for the LAN port LED indications.

LAN port LED indications

ACT/LINK LED		SPEED LED	
Status	Description	Status	Description
OFF	No link	OFF	10 Mbps connection
GREEN	Linked	ORANGE	100 Mbps connection
BLINKING	Data activity	GREEN	1 Gbps connection

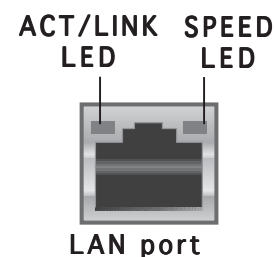

5. **Rear Speaker Out port (gray).** This port connects the rear speakers on a 4-channel, 6-channel, or 8-channel audio configuration.
6. **Side Speaker Out port (black).** This port connects the side speakers in an 8-channel audio configuration.
7. **Line In port (light blue).** This port connects a tape, CD, DVD player, or other audio sources.
8. **Line Out port (lime).** This port connects a headphone or a speaker. In 4-channel, 6-channel, and 8-channel configuration, the function of this port becomes Front Speaker Out.

- 9. Microphone port (pink).** This port connects a microphone.
- 10. Center/Subwoofer port (yellow orange).** This port connects the center/subwoofer speakers.



Refer to the audio configuration table for the function of the audio ports in 2, 4, 6, or 8-channel configuration.

Audio 2, 4, 6, or 8-channel configuration

Port	Headset 2-channel	4-channel	6-channel	8-channel
Light Blue	Line In	Line In	Line In	Line In
Lime	Line Out	Front Speaker Out	Front Speaker Out	Front Speaker Out
Pink	Mic In	Mic In	Mic In	Mic In
Gray	—	Rear Speaker Out	Rear Speaker Out	Rear Speaker Out
Black	—	—	—	Side Speaker Out
Yellow Orange	—	—	Center/Subwoofer	Center/Subwoofer

- 11. USB 2.0 ports 3 and 4.** These two 4-pin Universal Serial Bus (USB) ports are available for connecting USB 2.0 devices.
- 12. USB 2.0 ports 1 and 2.** These two 4-pin Universal Serial Bus (USB) ports are available for connecting USB 2.0 devices.
- 13. Serial connector.** This 9-pin COM1 port is for serial devices.
- 14. Optical S/PDIF Out port.** This port connects an external audio output device via an optical S/PDIF cable.
- 15. Coaxial S/PDIF Out port.** This port connects an external audio output device via a coaxial S/PDIF cable.
- 16. PS/2 keyboard port (purple).** This port is for a PS/2 keyboard.

1.7.2 Internal connectors

1. Floppy disk drive connector (34-1 pin FLOPPY)

This connector is for the provided floppy disk drive (FDD) signal cable. Insert one end of the cable to this connector, then connect the other end to the signal connector at the back of the floppy disk drive.



Pin 5 on the connector is removed to prevent incorrect cable connection when using an FDD cable with a covered Pin 5.

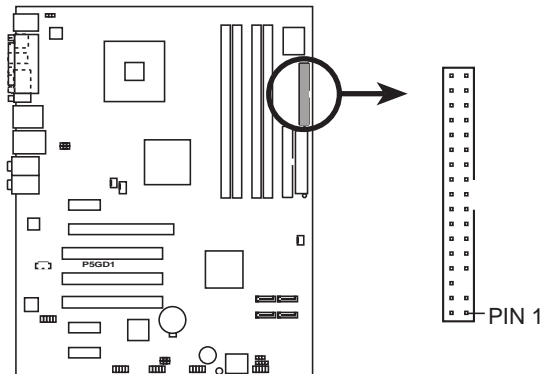

FLOPPY

NOTE: Orient the red markings on the floppy ribbon cable to PIN 1.

P5GD1 Floppy disk drive connector

2. Primary IDE connector (40-1 pin PRI_IDE)

This connector is for an Ultra DMA 100/66 signal cable. The Ultra DMA 100/66 signal cable has three connectors: a blue connector for the primary IDE connector on the motherboard, a black connector for an Ultra DMA 100/66 IDE slave device (optical drive/hard disk drive), and a gray connector for an Ultra DMA 100/66 IDE master device (hard disk drive). If you install two hard disk drives, you must configure the second drive as a slave device by setting its jumper accordingly. Refer to the hard disk documentation for the jumper settings.



- Pin 20 on the IDE connector is removed to match the covered hole on the Ultra DMA cable connector. This prevents incorrect insertion when you connect the IDE cable.
- Use the 80-conductor IDE cable for Ultra DMA 100/66 IDE devices.

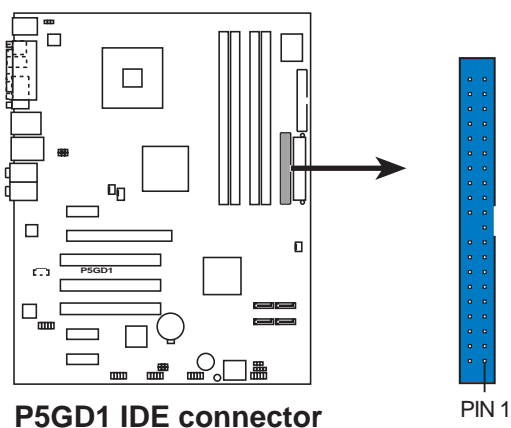

PRI_IDE

NOTE: Orient the red markings (usually zigzag) on the IDE ribbon cable to PIN 1.

P5GD1 IDE connector

PIN 1

3. Serial ATA connectors (7-pin SATA1, SATA2, SATA3, SATA4)

These connectors are for the Serial ATA signal cables for Serial ATA hard disk drives.

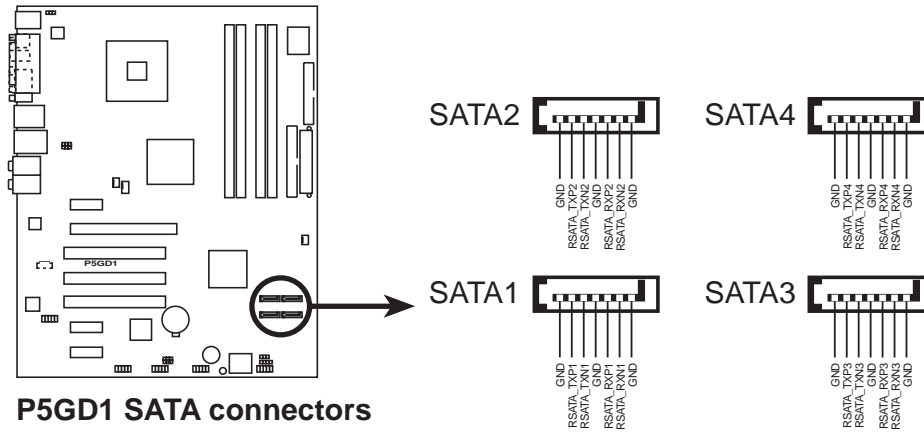

Important notes on Serial ATA

- Install the Windows® 2000 Service Pack 4 or the Windows® XP Service Pack1 before using Serial ATA.
- Plug your Serial ATA boot disk on the master port (SATA1 and SATA2) to support S3 function. Refer to the table below for details.

Serial ATA Master/Slave connectors

Connector	Setting	Use
SATA1, SATA2	Master	Boot disk
SATA3, SATA4	Slave	Data disk

4. CPU, Chassis, and Power fan connectors (4-pin CPU_FAN, 3-pin PWR_FAN, 3-pin CHA_FAN)

The fan connectors support cooling fans of 350mA~740mA (8.88W max.) or a total of 1A~2.22A (26.64W max.) at +12V. Connect the fan cables to the fan connectors on the motherboard, making sure that the black wire of each cable matches the ground pin of the connector.



Do not forget to connect the fan cables to the fan connectors. Insufficient air flow inside the system may damage the motherboard components. These are not jumpers! DO NOT place jumper caps on the fan connectors.

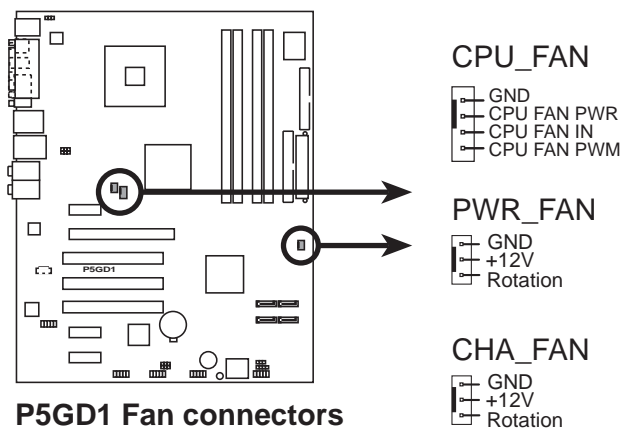

5. USB connectors (10-1 pin USB56, USB78)

These connectors are for USB 2.0 ports. Connect the USB/GAME module cable to any of these connectors, then install the module to a slot opening at the back of the system chassis. These USB connectors comply with USB 2.0 specification that supports up to 480 Mbps connection speed.

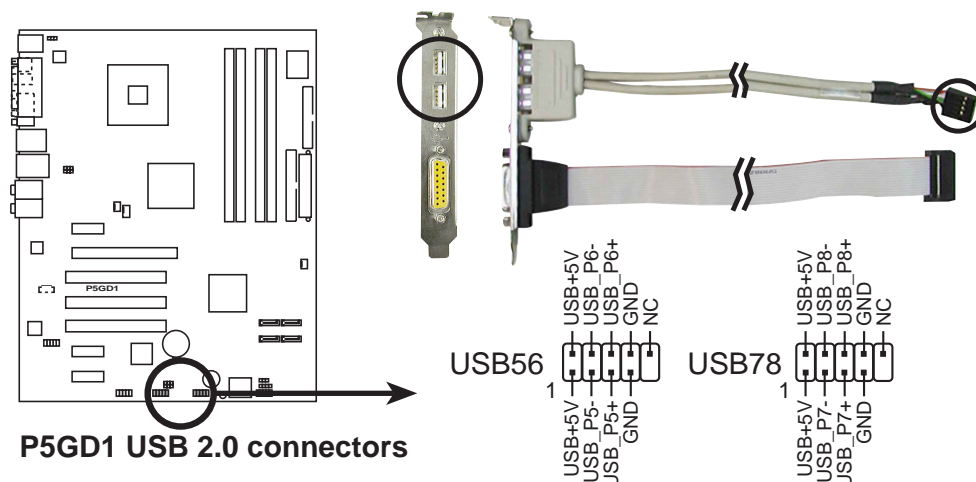

Never connect a 1394 cable to the USB connectors. Doing so will damage the motherboard!

6. ATX power connectors (24-pin EATXPWR, 4-pin ATX12V)

These connectors are for an ATX power supply. The plugs from the power supply are designed to fit these connectors in only one orientation. Find the proper orientation and push down firmly until the connectors completely fit.



- We recommend that you use an ATX 12 V Specification 2.0-compliant power supply unit (PSU) with a minimum of 300 W power rating. This PSU type has 24-pin and 4-pin power plugs.
- If you intend to use a PSU with 20-pin and 4-pin power plugs, make sure that the 20-pin power plug can provide at least 15A on +12V and that the PSU has a minimum power rating of 300 W. The system may become unstable or may not boot up if the power is inadequate.
- Do not forget to connect the 4-pin ATX +12 V power plug; otherwise, the system will not boot up.
- Use of a PSU with a higher power output is recommended when configuring a system with more power-consuming devices. The system may become unstable or may not boot up if the power is inadequate.
- The ATX 12 V Specification 2.0-compliant PSU passed the motherboard power requirement test with the following configuration:

CPU	:	Intel® Pentium® 4 3.6 GHz
Memory	:	512 MB DDR (x 4)
Graphics card	:	PCI Express x16 Nvidia EN5900
Parallel ATA devices:	:	IDE hard disk drive (x 2)
Serial ATA device	:	SATA hard disk drive
Optical drives	:	CD-ROM (x 2)
SCSI devices	:	SCSI card and SCSI hard disk drive

- You must install a PSU with a higher power rating if you intend to install additional devices.

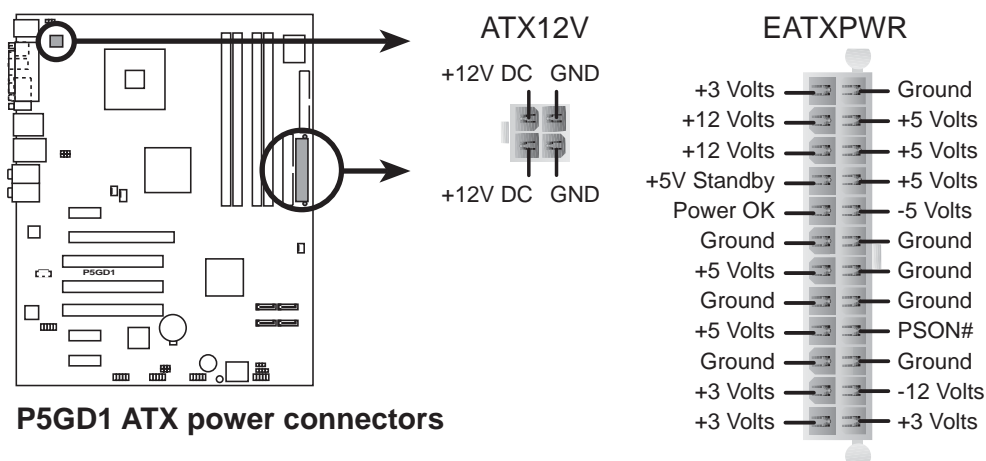

7. Optical drive audio connector (4-pin CD)

This connector is for the 4-pin audio cable that connects to the audio connector at the back of the optical drive.

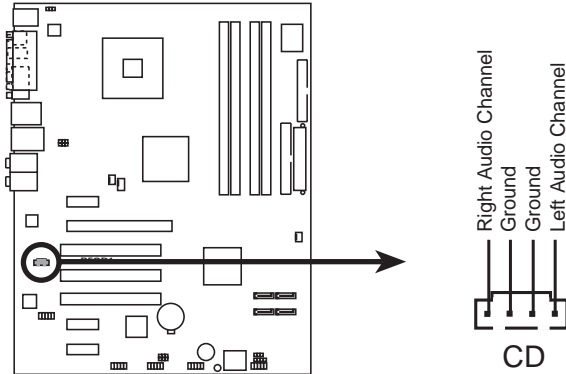

P5GD1 CD audio connector

8. Front panel audio connector (10-1 pin AAFP)

This connector is for a chassis-mounted front panel audio I/O module that supports either HD Audio or legacy AC '97 audio standard. Connect one end of the front panel audio I/O module cable to this connector.

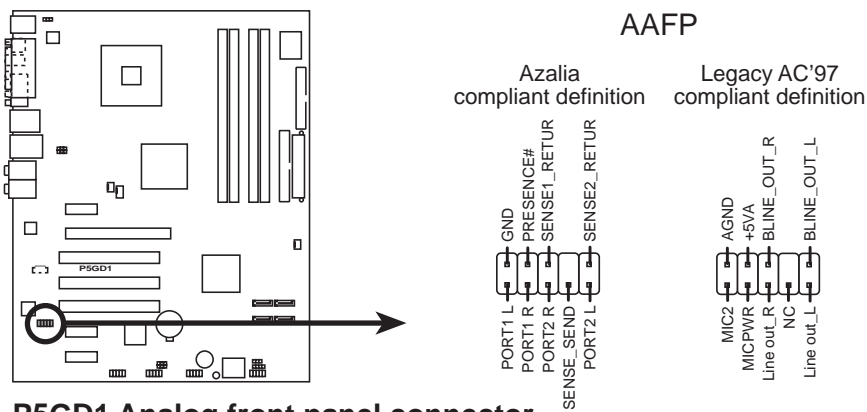

P5GD1 Analog front panel connector



Connect a high-definition front panel audio module to this connector to avail of the high-definition audio features of the motherboard.

9. Chassis intrusion connector (4-1 pin CHASSIS)

This connector is for a chassis-mounted intrusion detection sensor or switch. Connect one end of the chassis intrusion sensor or switch cable to this connector. The chassis intrusion sensor or switch sends a high-level signal to this connector when a chassis component is removed or replaced. The signal is then generated as a chassis intrusion event.

By default, the pins labeled “Chassis Signal” and “Ground” are shorted with a jumper cap. Remove the jumper caps only when you intend to use the chassis intrusion detection feature.

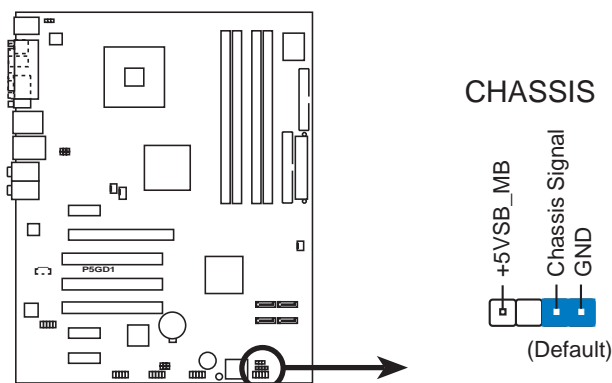

P5GD1 Chassis intrusion connector

10. IEEE 1394a connector (10-1 pin IE1394_2)

This connector is for an IEEE 1394a port. Connect the IEEE 1394a module cable to this connector, then install the module to a slot opening at the back of the system chassis.

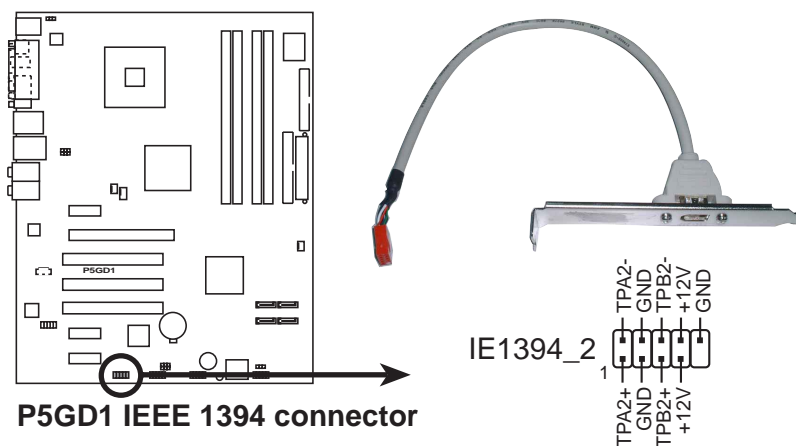

P5GD1 IEEE 1394 connector



Never connect a **USB cable** to the IEEE 1394a connector. Doing so will damage the motherboard!

11. System panel connector (10-1 pin F_PANEL)

This connector supports several chassis-mounted functions.

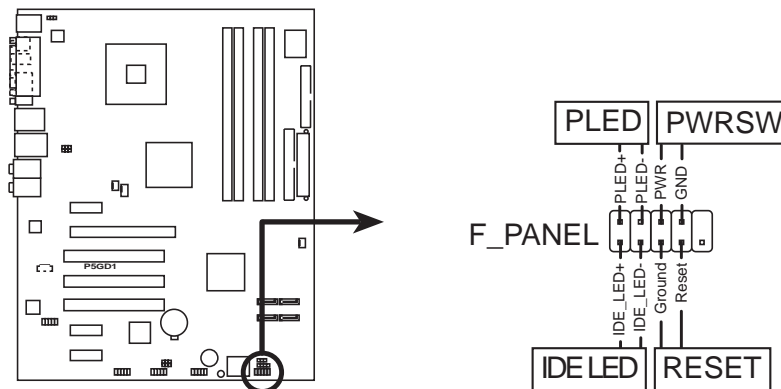

P5GD1 System panel connector * Requires an ATX power supply.

- **System power LED (2-pin PLED)**
This 2-pin connector is for the system power LED. Connect the chassis power LED cable to this connector. The system power LED lights up when you turn on the system power, and blinks when the system is in sleep mode.
- **Power/Soft-off button (2-pin PWRSW)**
This connector is for the system power button. Pressing the power button turns the system ON or puts the system in SLEEP or SOFT-OFF mode depending on the BIOS settings. Pressing the power switch for more than four seconds while the system is ON turns the system OFF.
- **Reset button (2-pin RESET)**
This 2-pin connector is for the chassis-mounted reset button for system reboot without turning off the system power.
- **Hard disk drive activity (2-pin IDELED)**
This 2-pin connector is for the HDD Activity LED. Connect the HDD Activity LED cable to this connector. The IDE LED lights up or flashes when data is read from or written to the HDD.

This chapter tells how to change the system settings through the BIOS Setup menus. Detailed descriptions of the BIOS parameters are also provided.

BIOS setup

Chapter summary



2.1	Managing and updating your BIOS	2-1
2.2	BIOS setup program	2-5
2.3	Main menu	2-8
2.4	Advanced menu	2-12
2.5	Power menu	2-17
2.6	Boot menu	2-21
2.7	Exit menu	2-25

2.1 Managing and updating your BIOS

The following utilities allow you to manage and update the motherboard Basic Input/Output System (BIOS) setup.

1. **ASUS AFUDOS** (Updates the BIOS in DOS mode using a bootable floppy disk.)
2. **ASUS EZ Flash** (Updates the BIOS using a floppy disk during POST.)

Refer to the corresponding sections for details on these utilities.



Save a copy of the original motherboard BIOS file to a bootable floppy disk in case you need to restore the BIOS in the future. Copy the original motherboard BIOS using the AFUDOS utility.

2.1.1 Creating a bootable floppy disk

1. Do either one of the following to create a bootable floppy disk.

DOS environment

- a. Insert a 1.44MB floppy disk into the drive.
- b. At the DOS prompt, type `format A:/S` then press <Enter>.

Windows® XP environment

- a. Insert a 1.44 MB floppy disk to the floppy disk drive.
- b. Click **Start** from the Windows® desktop, then select **My Computer**.
- c. Select the 3 1/2 Floppy Drive icon.
- d. Click **File** from the menu, then select **Format**. A **Format 3 1/2 Floppy Disk** window appears.
- e. Select **Create an MS-DOS startup disk** from the format options field, then click **Start**.

Windows® 2000 environment

To create a set of boot disks for Windows® 2000:

- a. Insert a formatted, high density 1.44 MB floppy disk into the drive.
- b. Insert the Windows® 2000 CD to the optical drive.
- c. Click **Start**, then select **Run**.
- d. From the Open field, type
`D:\bootdisk\makeboot a:`
assuming that D: is your optical drive.
- e. Press <Enter>, then follow screen instructions to continue.

2. Copy the original or the latest motherboard BIOS file to the bootable floppy disk.

2.1.2 ASUS EZ Flash utility

The ASUS EZ Flash feature allows you to update the BIOS without having to go through the long process of booting from a floppy disk and using a DOS-based utility. The EZ Flash utility is built-in the BIOS chip so it is accessible by pressing <Alt> + <F2> during the Power-On Self-Tests (POST).

To update the BIOS using EZ Flash:

1. Visit the system builder's website to download the latest BIOS file for the motherboard and rename the same to **P5GD1A.ROM**.
2. Save the BIOS file to a floppy disk, then restart the system.
3. Press <Alt> + <F2> during POST to display the following.

```
EZFlash starting BIOS update
Checking for floppy...
```

4. Insert the floppy disk that contains the BIOS file to the floppy disk drive. When the correct BIOS file is found, EZ Flash performs the BIOS update process and automatically reboots the system when done.

```
EZFlash starting BIOS update
Checking for floppy...
Floppy found!
Reading file "P5GD1A.ROM". Completed.
Start erasing.....|
Start programming...|
Flashed successfully. Rebooting.
```



- Do not shut down or reset the system while updating the BIOS to prevent system boot failure!
- A "Floppy not found!" error message appears if there is no floppy disk in the drive. A "P5GD1A.ROM not found!" error message appears if the correct BIOS file is not found in the floppy disk. Make sure that you rename the BIOS file to P5GD1A.ROM.

2.1.3 AFUDOS utility

The AFUDOS utility allows you to update the BIOS file in DOS environment using a bootable floppy disk with the updated BIOS file. This utility also allows you to copy the current BIOS file that you can use as backup when the BIOS fails or gets corrupted during the updating process.

Copying the current BIOS

To copy the current BIOS file using the AFUDOS utility:



- Make sure that the floppy disk is not write-protected and has at least 600 KB free space to save the file.
- The succeeding BIOS screens are for reference only. The actual BIOS screen displays may not be exactly the same as shown.

1. Copy the AFUDOS utility (afudos.exe) to the bootable floppy disk you created earlier.
2. Boot the system in DOS mode, then at the prompt type:

```
afudos /o[filename]
```

where the [filename] is any user-assigned filename not more than eight alphanumeric characters for the main filename and three alphanumeric characters for the extension name.

```
A:\>afudos /oOLDBIOS1.ROM
```

Main filename Extension name

3. Press <Enter>. The utility copies the current BIOS file to the floppy disk.

```
A:\>afudos /oOLDBIOS1.ROM
AMI Firmware Update Utility - Version 1.10
Copyright (C) 2002 American Megatrends, Inc. All rights reserved.
  Reading flash ..... done
A:\>
```

The utility returns to the DOS prompt after copying the current BIOS file.

Updating the BIOS file

To update the BIOS file using the AFUDOS utility:

1. Visit the system builder website and download the latest BIOS file for the motherboard. Save the BIOS file to a bootable floppy disk.



Write the BIOS filename on a piece of paper. You need to type the exact BIOS filename at the DOS prompt.

2. Copy the AFUDOS utility (afudos.exe) to the bootable floppy disk you created earlier.
3. Boot the system in DOS mode, then at the prompt type:

```
afudos /i[filename]
```

where [filename] is the latest or the original BIOS file on the bootable floppy disk.

```
A:\>afudos /iP5GD1A.ROM
```

4. The utility verifies the file and starts updating the BIOS.

```
A:\>afudos /iP5GD1A.ROM
AMI Firmware Update Utility - Version 1.10
Copyright (C) 2002 American Megatrends, Inc. All rights reserved.
Reading file ..... done
Erasing flash .... done
Writing flash .... 0x0008CC00 (9%)
```



Do not shut down or reset the system while updating the BIOS to prevent system boot failure!

5. The utility returns to the DOS prompt after the BIOS update process is completed. Reboot the system from the hard disk drive.

```
A:\>afudos /iP5GD1A.ROM
AMI Firmware Update Utility - Version 1.10
Copyright (C) 2002 American Megatrends, Inc. All rights reserved.
Reading file ..... done
Erasing flash .... done
Writing flash .... 0x0008CC00 (9%)
Verifying flash .. done
A:\>
```

2.2 BIOS setup program

This motherboard supports a programmable firmware chip that you can update using the utility described in section “2.1 Managing and updating your BIOS.”

Use the BIOS Setup program when you are installing a motherboard, reconfiguring your system, or prompted to “Run Setup.” This section explains how to configure your system using this utility.

Even if you are not prompted to use the Setup program, you can change the configuration of your computer in the future. For example, you can enable the security password feature or change the power management settings. This requires you to reconfigure your system using the BIOS Setup program so that the computer can recognize these changes and record them in the CMOS RAM of the firmware hub.

The firmware hub on the motherboard stores the Setup utility. When you start up the computer, the system provides you with the opportunity to run this program. Press during the Power-On Self-Test (POST) to enter the Setup utility; otherwise, POST continues with its test routines.

If you wish to enter Setup after POST, restart the system by pressing <Ctrl+Alt+Delete>, or by pressing the reset button on the system chassis. You can also restart by turning the system off and then back on. Do this last option only if the first two failed.

The Setup program is designed to make it as easy to use as possible. Being a menu-driven program, it lets you scroll through the various sub-menus and make your selections from the available options using the navigation keys.



-
- The default BIOS settings for this motherboard apply for most conditions to ensure optimum performance. If the system becomes unstable after changing any BIOS settings, load the default settings to ensure system compatibility and stability. Select the **Load Default Settings** item under the Exit Menu. See section “2.7 Exit Menu.”
 - The BIOS setup screens shown in this section are for reference purposes only, and may not exactly match what you see on your screen.
 - Visit the system builder’s website to download the latest BIOS file for this motherboard.
-

2.2.1 BIOS menu screen

Menu items Menu bar Configuration fields General help

The screenshot shows the BIOS Setup Utility menu. At the top is a blue menu bar with the title 'BIOS SETUP UTILITY' and five main items: 'Main', 'Advanced', 'Power', 'Boot', and 'Exit'. The 'Main' item is currently selected and highlighted. Below the menu bar, the screen is divided into three main sections. The left section, labeled 'Menu items', contains a list of options: 'System Time', 'System Date', 'Legacy Diskette A', and 'Language'. Below these are several IDE controller settings, each with a blue arrow pointing to the right, and 'System Information'. The middle section, labeled 'Configuration fields', shows the current values for the selected 'System Time' field: '[11:10:19]', '[Thu 03/27/2003]', '[1.44M, 3.5 in]', and '[English]'. The right section, labeled 'General help', contains two text boxes. The top one explains that [ENTER], [TAB], or [SHIFT-TAB] are used to select a field, and [+] or [-] are used to configure system time. The bottom one lists navigation keys: left arrow for 'Select Screen', up/down arrows for 'Select Item', +/- for 'Change Field', Tab for 'Select Field', F1 for 'General Help', F10 for 'Save and Exit', and ESC for 'Exit'. At the bottom of the screen, a blue bar contains the copyright notice: '(C)Copyright 1985-2002, American Megatrends, Inc.'.

Sub-menu items Navigation keys

2.2.2 Menu bar

The menu bar on top of the screen has the following main items:

- Main** For changing the basic system configuration
- Advanced** For changing the advanced system settings
- Power** For changing the advanced power management (APM) configuration
- Boot** For changing the system boot configuration
- Exit** For selecting the exit options and loading default settings

To select an item on the menu bar, press the right or left arrow key on the keyboard until the desired item is highlighted.

2.2.3 Navigation keys

At the bottom right corner of a menu screen are the navigation keys for that particular menu. Use the navigation keys to select items in the menu and change the settings.



Some of the navigation keys differ from one screen to another.

2.2.4 Menu items

The highlighted item on the menu bar displays the specific items for that menu. For example, selecting **Main** shows the Main menu items.

The other items (Advanced, Power, Boot, and Exit) on the menu bar have their respective menu items.

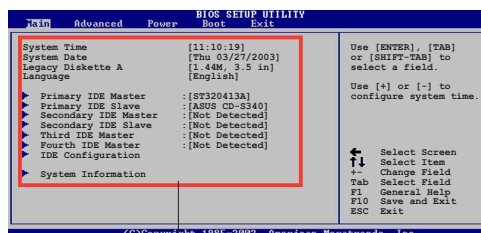

Main menu items

2.2.5 Sub-menu items

A solid triangle before each item on any menu screen means that the item has a sub-menu. To display the sub-menu, select the item and press <Enter>.

2.2.6 Configuration fields

These fields show the values for the menu items. If an item is user-configurable, you can change the value of the field opposite the item. You cannot select an item that is not user-configurable.

A configurable field is enclosed in brackets, and is highlighted when selected. To change the value of a field, select it then press <Enter> to display a list of options. Refer to “2.2.7 Pop-up window.”

2.2.7 Pop-up window

Select a menu item then press <Enter> to display a pop-up window with the configuration options for that item.

2.2.8 Scroll bar

A scroll bar appears on the right side of a menu screen when there are items that do not fit on the screen. Press the Up/Down arrow keys or <Page Up> / <Page Down> keys to display the other items on the screen.

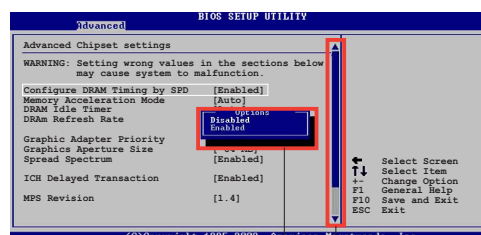

Pop-up window

Scroll bar

2.2.9 General help

At the top right corner of the menu screen is a brief description of the selected item.

2.3 Main menu

When you enter the BIOS Setup program, the Main menu screen appears, giving you an overview of the basic system information.



Refer to section “2.2.1 BIOS menu screen” for information on the menu screen items and how to navigate through them.

```

BIOS SETUP UTILITY
Main  Advanced  Power  Boot  Exit

System Time           [11:51:19]
System Date           [Thu 05/07/2004]
Legacy Diskette A     [1.44M, 3.5 in]
Language               [English]

▶ Primary IDE Master   : [ST320413A]
▶ Primary IDE Slave   : [Not Detected]
▶ Third IDE Master     : [Not Detected]
▶ Third IDE Slave     : [Not Detected]
▶ Fourth IDE Master    : [Not Detected]
▶ Fourth IDE Slave    : [Not Detected]
▶ IDE Configuration

▶ System Information

↔ Select Screen
↑↓ Select Item
+ - Change Option
F1 General Help
F10 Save and Exit
ESC Exit

v00.00 (C)Copyright 1985-2002, American Megatrends, Inc.
```

2.3.1 System Time [xx:xx:xxxx]

Allows you to set the system time.

2.3.2 System Date [Day xx/xx/xxxx]

Allows you to set the system date.

2.3.3 Legacy Diskette A [1.44M, 3.5 in.]

Sets the type of floppy drive installed. Configuration options: [Disabled]
[360K, 5.25 in.] [1.2M , 5.25 in.] [720K , 3.5 in.] [1.44M, 3.5 in.]
[2.88M, 3.5 in.]

2.3.4 Language [English]

Allows you to choose the BIOS language version from the options.
Configuration options: [Français] [German] [English]

2.3.5 Primary, Third and Fourth IDE Master/Slave

While entering Setup, the BIOS automatically detects the presence of IDE devices. There is a separate sub-menu for each IDE device. Select a device item then press <Enter> to display the IDE device information.

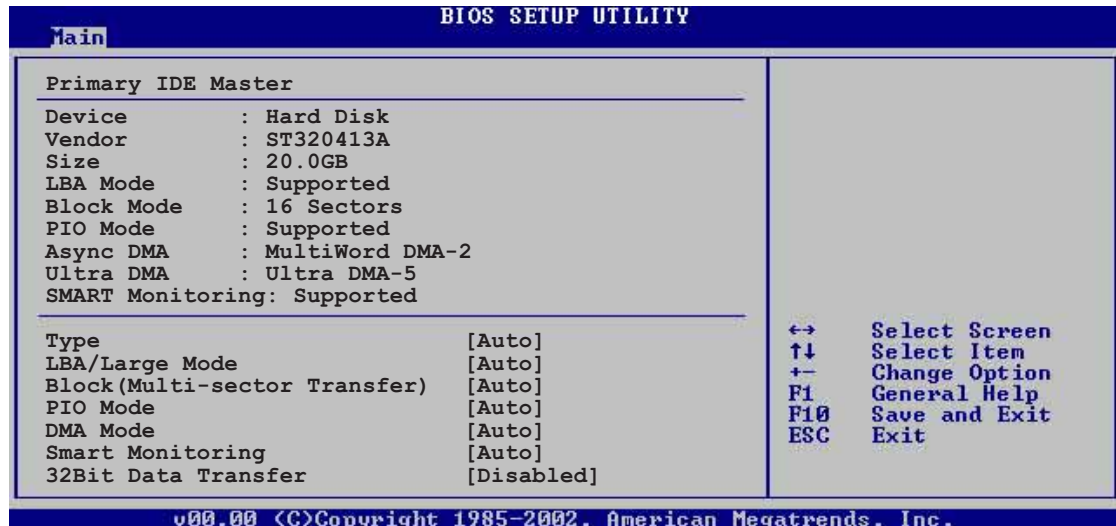

The BIOS automatically detects the values opposite the dimmed items (Device, Vendor, Size, LBA Mode, Block Mode, PIO Mode, Async DMA, Ultra DMA, and SMART monitoring). These values are not user-configurable. These items show N/A if no IDE device is installed in the system.

Type [Auto]

Selects the type of IDE drive. Setting to Auto allows automatic selection of the appropriate IDE device type. Select CDROM if you are specifically configuring a CD-ROM drive. Select ARMD (ATAPI Removable Media Device) if your device is either a ZIP, LS-120, or MO drive.

Configuration options: [Not Installed] [Auto] [CDROM] [ARMD]

LBA/Large Mode [Auto]

Enables or disables the LBA mode. Setting to Auto enables the LBA mode if the device supports this mode, and if the device was not previously formatted with LBA mode disabled. Configuration options: [Disabled] [Auto]

Block (Multi-sector Transfer) [Auto]

Enables or disables data multi-sectors transfers. When set to Auto, the data transfer from and to the device occurs multiple sectors at a time if the device supports multi-sector transfer feature. When set to [Disabled], the data transfer from and to the device occurs one sector at a time.

Configuration options: [Disabled] [Auto]

PIO Mode [Auto]

Selects the PIO mode.

Configuration options: [Auto] [0] [1] [2] [3] [4]

DMA Mode [Auto]

Selects the DMA mode. Configuration options: [Auto] [SWDMA0] [SWDMA1] [SWDMA2] [MWDMA0] [MWDMA1] [MWDMA2] [UDMA0] [UDMA1] [UDMA2] [UDMA3] [UDMA4] [UDMA5]

SMART Monitoring [Auto]

Sets the Smart Monitoring, Analysis, and Reporting Technology.

Configuration options: [Auto] [Disabled] [Enabled]

32Bit Data Transfer [Disabled]

Enables or disables 32-bit data transfer.

Configuration options: [Disabled] [Enabled]

2.3.6 IDE Configuration

The items in this menu allow you to set or change the configurations for the IDE devices installed in the system. Select an item then press <Enter> if you wish to configure the item.

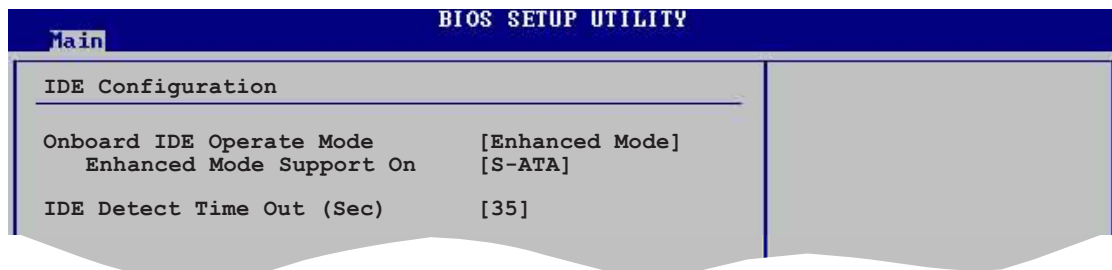

Onboard IDE Operate Mode [Enhanced Mode]

Allows selection of the IDE operation mode depending on the operating system (OS) that you installed. Set to Enhanced Mode if you are using native OS, such as Windows® 2000/XP/2003 Server.

Configuration options: [Compatible Mode] [Enhanced Mode]

Enhanced Mode Support On [S-ATA]

The default setting S-ATA allows you to use native OS on Serial ATA and Parallel ATA ports. We recommend that you do not change the default setting for better OS compatibility. In this setting, you may use legacy OS on the Parallel ATA ports **only** if you did not install any Serial ATA device.

The P-ATA+S-ATA and P-ATA options are for advanced users only. If you set to any of these options and encounter problems, revert to the default setting **S-ATA**. Configuration options: [P-ATA+S-ATA] [S-ATA] [P-ATA]



The **Onboard IDE Operate Mode** and its submenu items appear only when the **Configure SATA As** item is set to Standard IDE.

IDE Detect Time Out [35]

Selects the time out value for detecting ATA/ATAPI devices.
Configuration options: [0] [5] [10] [15] [20] [25] [30] [35]

2.3.7 System Information

This menu gives you an overview of the general system specifications. The BIOS automatically detects the items in this menu.

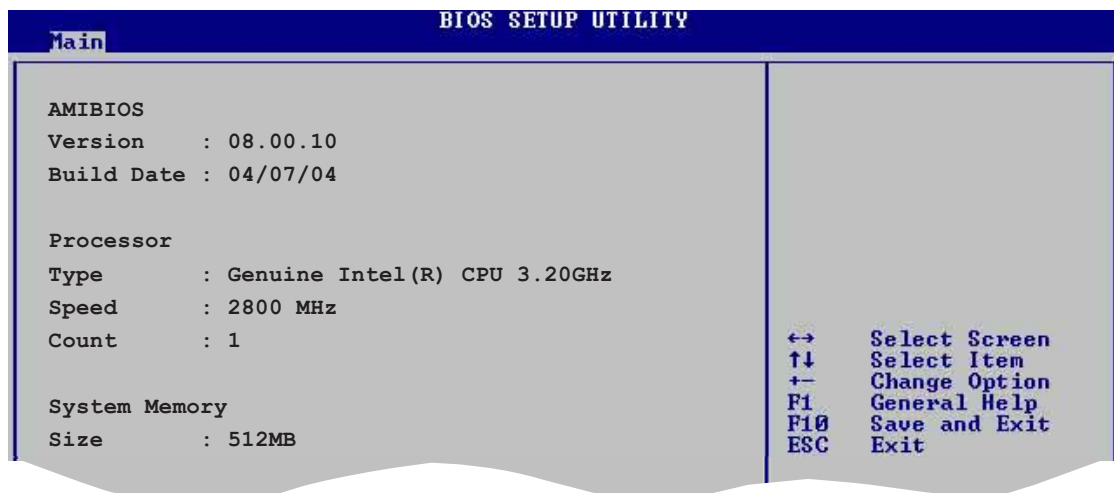

AMI BIOS

Displays the auto-detected BIOS information

Processor

Displays the auto-detected CPU specification

System Memory

Displays the auto-detected system memory

2.4 Advanced menu

The Advanced menu items allow you to change the settings for the CPU and other system devices.



Take caution when changing the settings of the Advanced menu items. Incorrect field values can cause the system to malfunction.

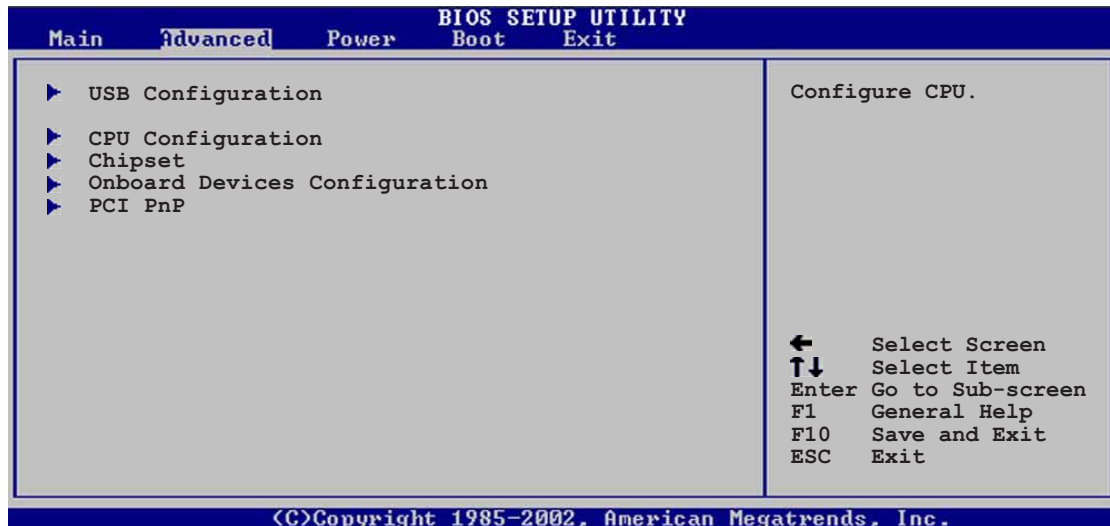

2.4.1 USB Configuration

The items in this menu allows you to change the USB-related features. Select an item then press <Enter> to display the configuration options.

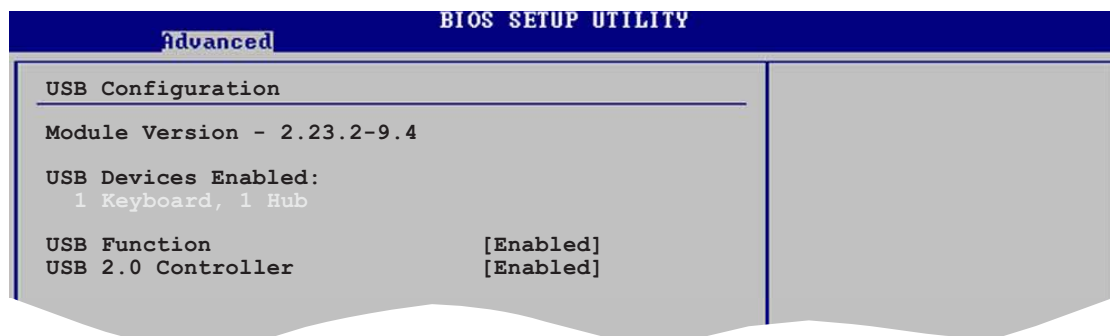

The Module Version and USB Devices Enabled items show the auto-detected values. If no USB device is detected, the item shows None.

USB Function [Enabled]

Allows you to enable or disable the USB function.
Configuration options: [Disabled] [Enabled]

USB 2.0 Controller [Enabled]

Allows you to enable or disable the USB 2.0 controller.
Configuration options: [Disabled] [Enabled]

USB 2.0 Controller Mode [HiSpeed]

Allows you to configure the USB 2.0 controller in HiSpeed (480 Mbps) or Full Speed (12 Mbps). Configuration options: [HiSpeed] [Full Speed]

2.4.2 CPU Configuration

The items in this menu show the CPU-related information that the BIOS automatically detects.

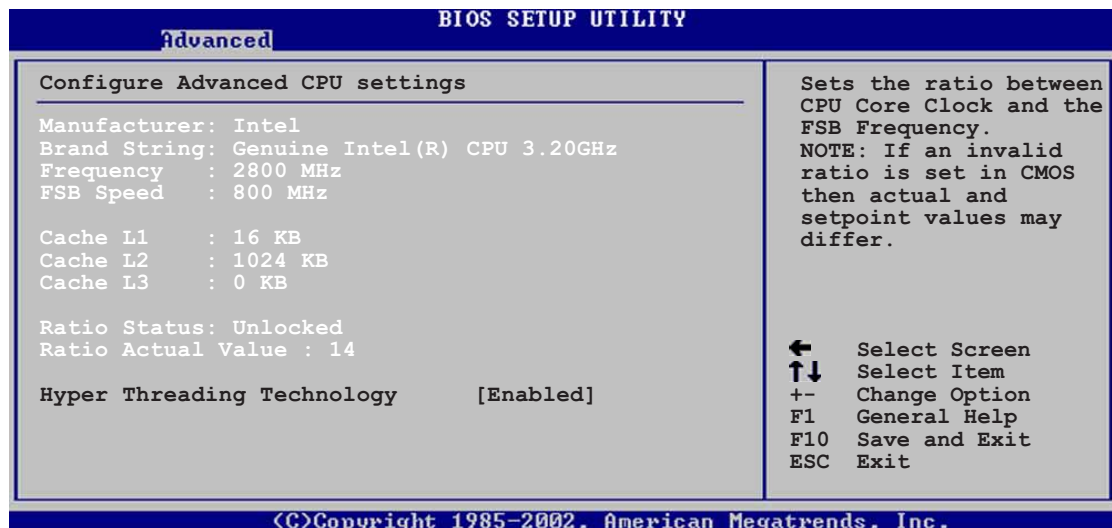

Hyper-Threading Technology [Enabled]

Allows you to enable or disable the processor Hyper-Threading Technology.
Configuration options: [Disabled] [Enabled]

2.4.3 Chipset

The Chipset menu allows you to change the advanced chipset settings. Select an item then press <Enter> to display the sub-menu.

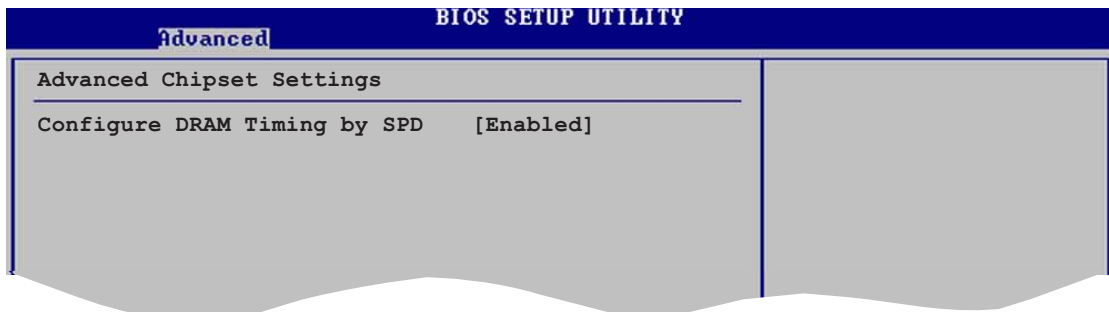

Advanced Chipset Settings

Configure DRAM Timing by SPD [Enabled]

When this item is enabled, the DRAM timing parameters are set according to the DRAM SPD (Serial Presence Detect). When disabled, you can manually set the DRAM timing parameters through the DRAM sub-items. The following sub-items appear when this item is Disabled.

Configuration options: [Disabled] [Enabled]

DRAM CAS# Latency [3 Clocks]

Controls the latency between the SDRAM read command and the time the data actually becomes available. Configuration options: [3 Clocks] [2.5 Clocks] [2 Clocks]

DRAM RAS# Precharge [4 Clocks]

Controls the idle clocks after issuing a precharge command to the DDR SDRAM. Configuration options: [2 Clocks] [3 Clocks] [4 Clocks] [5 Clocks]

DRAM RAS# to CAS# Delay [4 Clocks]

Controls the latency between the DDR SDRAM active command and the read/write command. Configuration options: [2 Clocks] [3 Clocks] [4 Clocks] [5 Clocks]

2.4.4 Onboard Devices Configuration

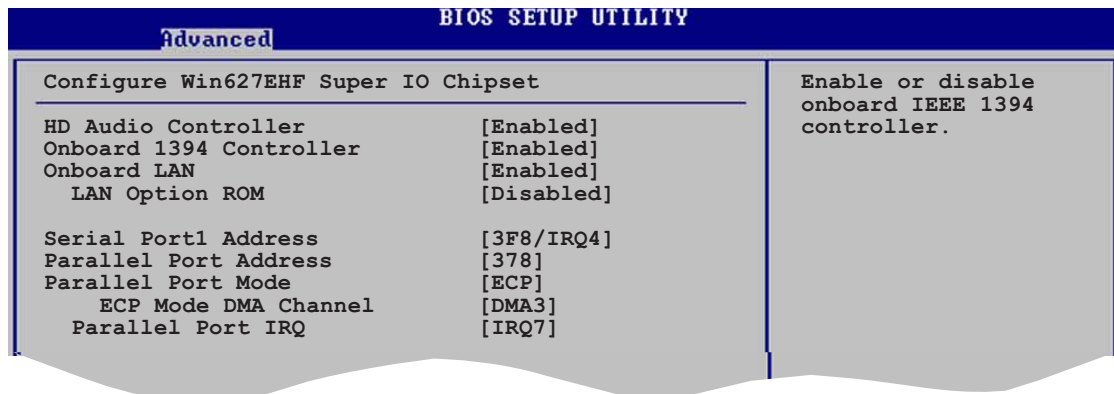

HD Audio Controller [Enabled]

Enables or disables the onboard high-definition audio controller.
Configuration options: [Enabled] [Disabled]

Onboard 1394 Controller [Enabled]

Enables or disables the onboard IEEE 1394a controller.
Configuration options: [Enabled] [Disabled]

OnBoard LAN [Enabled]

Allows you to enable or disable the onboard PCI Express Gigabit LAN controller. Configuration options: [Disabled] [Enabled]

LAN Option ROM [Disabled]

Allows you to enable or disable the option ROM in the onboard LAN controller. This item appears only when the Onboard LAN item is set to Enabled. Configuration options: [Disabled] [Enabled]

Serial Port1 Address [3F8/IRQ4]

Allows you to select the Serial Port1 base address.
Configuration options: [Disabled] [3F8/IRQ4] [3E8/IRQ4] [2E8/IRQ3]

Parallel Port Address [378]

Allows you to select the Parallel Port base addresses.
Configuration options: [Disabled] [378] [278] [3BC]

Parallel Port Mode [ECP]

Allows you to select the Parallel Port mode.
Configuration options: [Normal] [Bi-directional] [EPP] [ECP]

ECP Mode DMA Channel [DMA3]

Appears only when the Parallel Port Mode is set to [ECP]. This item allows you to set the Parallel Port ECP DMA.
Configuration options: [DMA0] [DMA1] [DMA3]

EPP Version [1.9]

Allows selection of the Parallel Port EPP version. This item appears only when the **Parallel Port Mode** is set to **EPP**.

Configuration options: [1.9] [1.7]

Parallel Port IRQ [IRQ7]

Configuration options: [IRQ5] [IRQ7]

2.4.5 PCI PnP

The PCI PnP menu items allow you to change the advanced settings for PCI/PnP devices. The menu includes setting IRQ and DMA channel resources for either PCI/PnP or legacy ISA devices, and setting the memory size block for legacy ISA devices.



Take caution when changing the settings of the PCI PnP menu items. Incorrect field values can cause the system to malfunction.

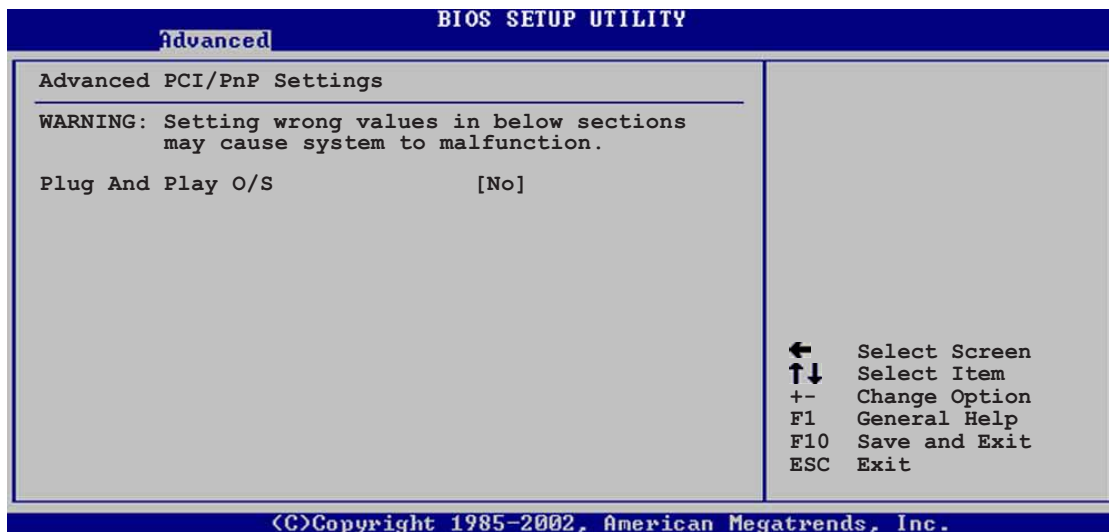

Plug and Play O/S [No]

When set to [No], BIOS configures all the devices in the system. When set to [Yes] and if you install a Plug and Play operating system, the operating system configures the Plug and Play devices not required for boot.

Configuration options: [No] [Yes]

2.5 Power menu

The Power menu items allow you to change the settings for the Advanced Configuration and Power Interface (ACPI) and the Advanced Power Management (APM). Select an item then press <Enter> to display the configuration options.



2.5.1 Suspend Mode [Auto]

Allows you to select the Advanced Configuration and Power Interface (ACPI) state to be used for system suspend.

Configuration options: [S1 (POS) Only] [S3 Only] [Auto]

2.5.2 Repost Video on S3 Resume [No]

Determines whether to invoke VGA BIOS POST on S3/STR resume.

Configuration options: [No] [Yes]

2.5.3 ACPI 2.0 Support [Yes]

Allows you to add more tables for Advanced Configuration and Power Interface (ACPI) 2.0 specifications. Configuration options: [No] [Yes]

2.5.4 ACPI APIC Support [Enabled]

Allows you to enable or disable the Advanced Configuration and Power Interface (ACPI) support in the Application-Specific Integrated Circuit (ASIC). When set to Enabled, the ACPI APIC table pointer is included in the RSDT pointer list. Configuration options: [Disabled] [Enabled]

2.5.5 APM Configuration

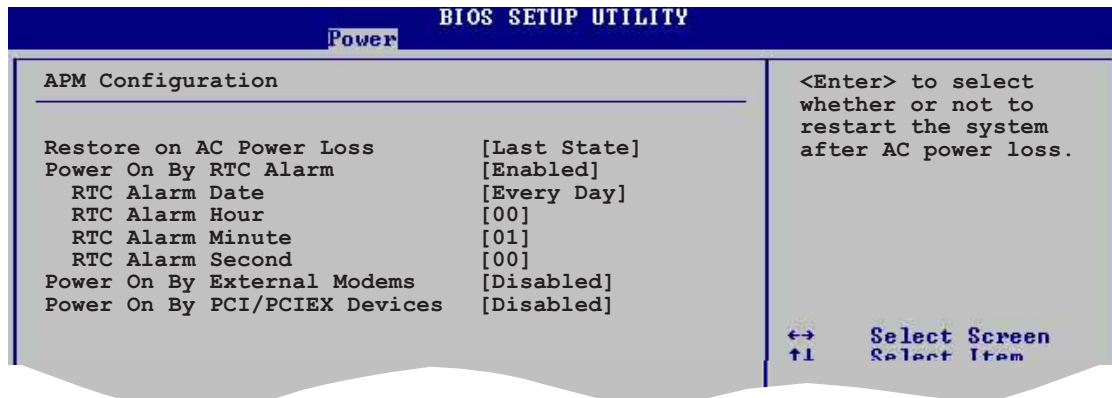

Restore on AC Power Loss [Last State]

When set to Power Off, the system goes into off state after an AC power loss. When set to Power On, the system goes on after an AC power loss. When set to Last State, the system goes into either off or on state, whatever the system state was before the AC power loss.

Configuration options: [Power Off] [Power On] [Last State]

Power On By RTC Alarm [Enabled]

Allows you to enable or disable RTC to generate a wake event. When this item is set to Enabled, the items RTC Alarm Date, RTC Alarm Hour, RTC Alarm Minute, and RTC Alarm Second appear with set values.

Configuration options: [Disabled] [Enabled]

RTC Alarm Date [Every Day]

Allows you to set the alarm date. Use the plus <+> or minus <-> keys to adjust the values. Configuration options: [Every Day] [01]~[31]

RTC Alarm Hour [00]

Allows you to set the alarm hour. Use the plus <+> or minus <-> keys to adjust the values. Configuration options: [00][01]~[23]

RTC Alarm Minute [01]

Allows you to set the alarm minute. Use the plus <+> or minus <-> keys to adjust the values. Configuration options: [00][01]~[59]

RTC Alarm Second [00]

Allows you to set the alarm second. Use the plus <+> or minus <-> keys to adjust the values. Configuration options: [00][01]~[59]

Power On By External Modems [Disabled]

This allows either settings of [Enabled] or [Disabled] for powering up the computer when the external modem receives a call while the computer is in Soft-off mode. Configuration options: [Disabled] [Enabled]



The computer cannot receive or transmit data until the computer and applications are fully running. Thus, connection cannot be made on the first try. Turning an external modem off and then back on while the computer is off causes an initialization string that turns the system power on.

Power On By PCI/PCIEX Devices [Disabled]

When set to [Enabled], this parameter allows you to turn on the system through a PCI or PCIEX LAN card. This feature requires an ATX power supply that provides at least 1A on the +5VSB lead.

Configuration options: [Disabled] [Enabled]

2.5.6 Hardware Monitor

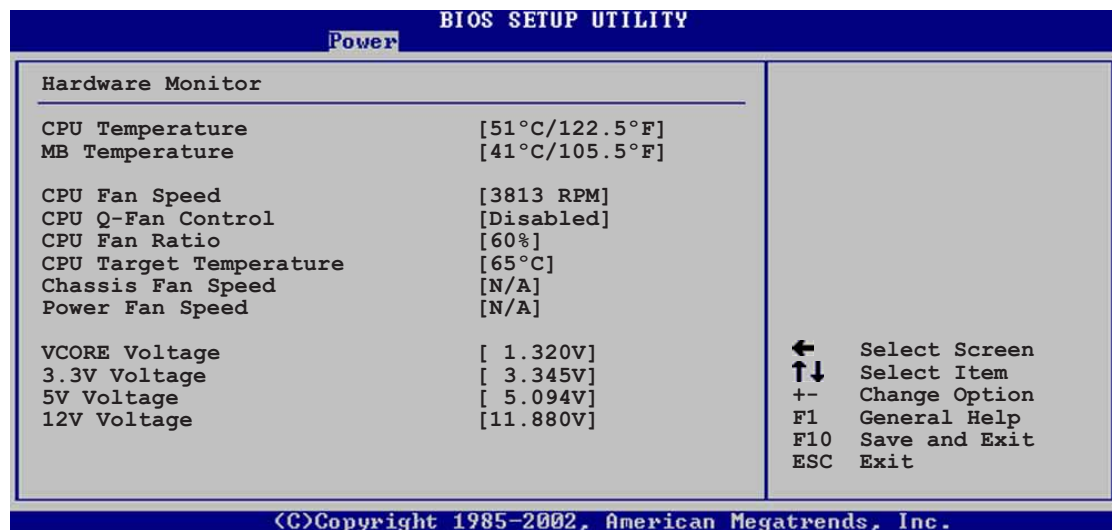

CPU Temperature [xxx°C/xxx°F]

MB Temperature [xxx°C/xxx°F]

The onboard hardware monitor automatically detects and displays the motherboard and CPU temperatures. Select Disabled if you do not wish to display the detected temperatures.

CPU Fan Speed [xxxxRPM] or [N/A]

The onboard hardware monitor automatically detects and displays the CPU fan speed in rotations per minute (RPM). If the fan is not connected to the motherboard, the field shows N/A.

CPU Q-Fan Control [Enabled]

Allows you to enable or disable the ASUS Q-Fan feature that smartly adjusts the fan speeds for more efficient system operation.

Configuration options: [Disabled] [Enabled]



The **CPU Fan Ratio** and **CPU Target Temperature** items appear when you enable the **CPU Q-Fan Control** feature.

CPU Fan Ratio [Auto]

Allows you to select the appropriate CPU fan speed ratio for the system. The default [Auto] automatically selects the fan speed ratio when operating a low CPU temperature. Select a higher ratio if you installed additional devices and the system requires more ventilation. This item appears only when the CPU Q-Fan Control item is Enabled.

Configuration options: [Auto] [20%] [30%] [40%] [50%]



Some CPU fans with a 4-pin cable do not comply with Intel®'s PWM fan specification. When using this type of CPU fan, you can not reduce the CPU fan speed even if you set the CPU Q-Fan Mode to [PWM].

CPU Target Temperature [65°C]

Allows you to set the CPU temperature threshold when the CPU fan speed is increased to lower the CPU temperature. This item appears only when the CPU Q-Fan Control item is Enabled. The configuration options vary depending on the CPU installed.

Chassis Fan Speed [xxxxRPM] or [N/A]

The onboard hardware monitor automatically detects and displays the chassis fan speed in rotations per minute (RPM). If the fan is not connected to the chassis, the specific field shows N/A.

Power Fan Speed [xxxxRPM] or [N/A]

The onboard hardware monitor automatically detects and displays the power fan speed in rotations per minute (RPM). If the fan is not connected to the power fan connector, the specific field shows N/A.

VCORE Voltage, 3.3V Voltage, 5V Voltage, 12V Voltage

The onboard hardware monitor automatically detects the voltage output through the onboard voltage regulators.

2.6 Boot menu

The Boot menu items allow you to change the system boot options. Select an item then press <Enter> to display the sub-menu.

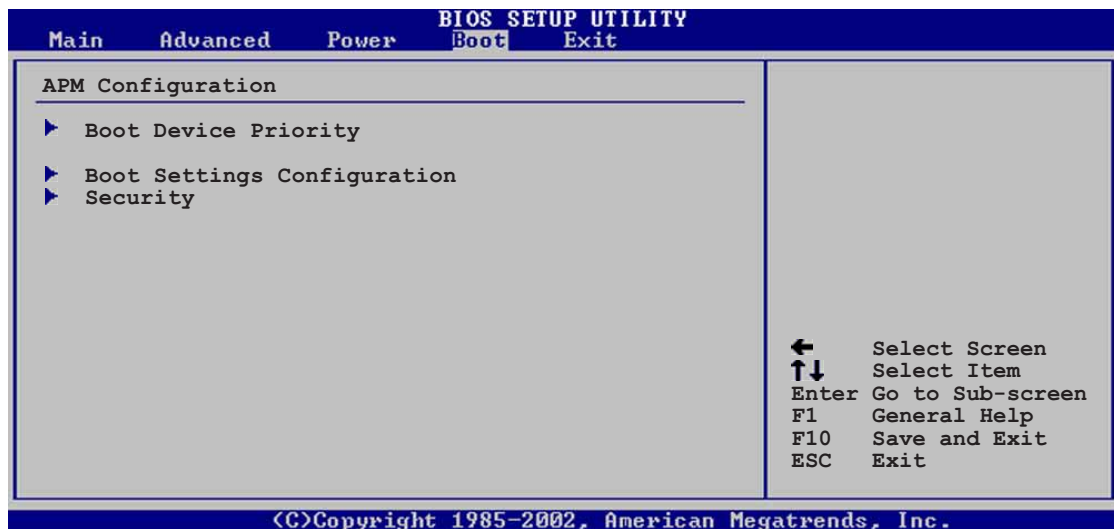

2.6.1 Boot Device Priority

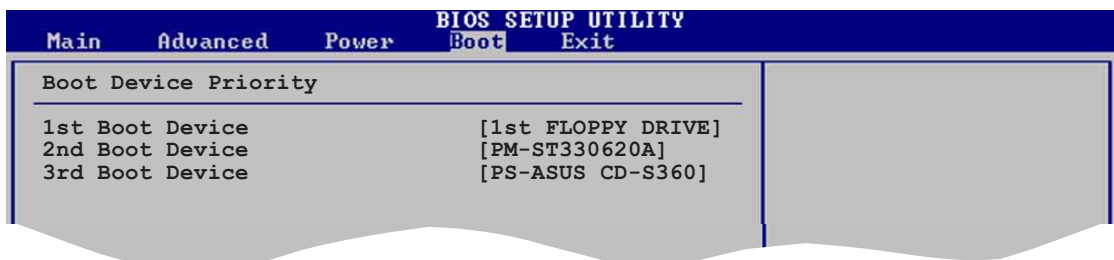

1st ~ xxth Boot Device [1st Floppy Drive]

These items specify the boot device priority sequence from the available devices. The number of device items that appears on the screen depends on the number of devices installed in the system.

Configuration options: [xxxxx Drive] [Disabled]

2.6.2 Boot Settings Configuration

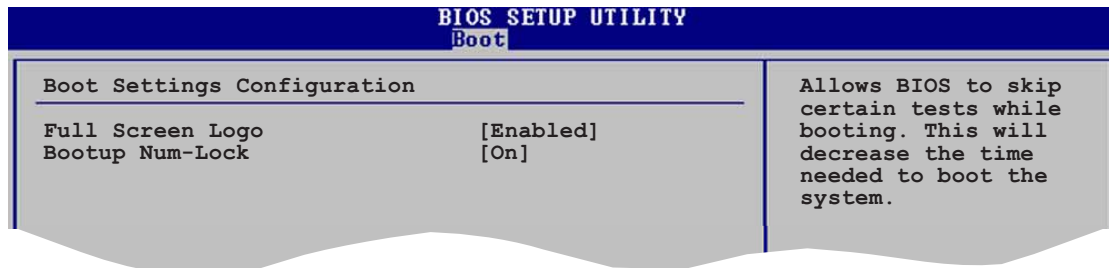

Full Screen Logo [Enabled]

This allows you to enable or disable the full screen logo display feature.
Configuration options: [Disabled] [Enabled]



Set this item to [Enabled] to use the ASUS MyLogo™ feature.

Bootup Num-Lock [On]

Allows you to select the power-on state for the NumLock.
Configuration options: [Off] [On]

2.6.3 Security

The Security menu items allow you to change the system security settings. Select an item then press <Enter> to display the configuration options.

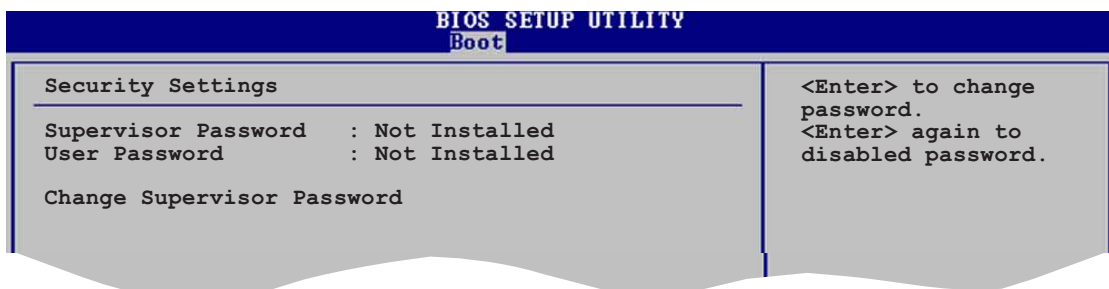

Change Supervisor Password

Select this item to set or change the supervisor password. The Supervisor Password item on top of the screen shows the default **Not Installed**. After you set a password, this item shows **Installed**.

To set a Supervisor Password:

1. Select the Change Supervisor Password item and press <Enter>.
2. From the password box, type a password composed of at least six letters and/or numbers, then press <Enter>.
3. Confirm the password when prompted.

The message “Password Installed” appears after you successfully set your password.

To change the supervisor password, follow the same steps as in setting a user password.

To clear the supervisor password, select the Change Supervisor Password then press <Enter>. The message “Password Uninstalled” appears.



If you forget your BIOS password, you can clear it by erasing the CMOS Real Time Clock (RTC) RAM. See section “1.6 Jumpers” for information on how to erase the RTC RAM.

After you have set a supervisor password, the other items appear to allow you to change other security settings.

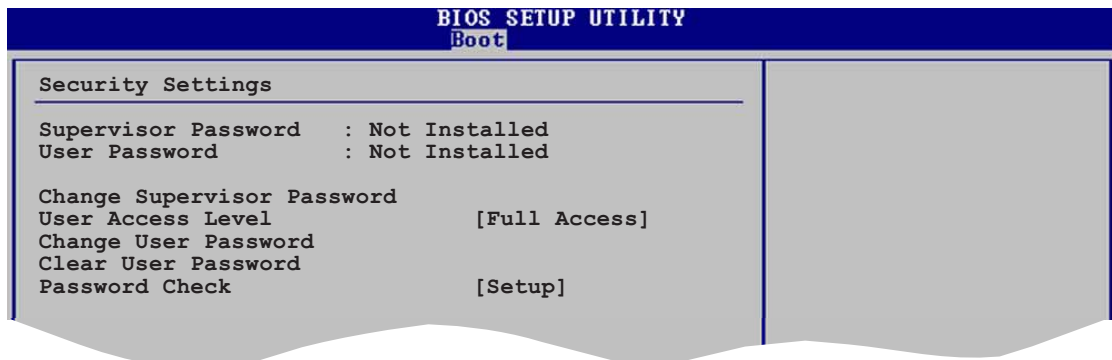

User Access Level (Full Access]

This item allows you to select the access restriction to the Setup items. Configuration options: [No Access] [View Only] [Limited] [Full Access]

No Access prevents user access to the Setup utility.

View Only allows access but does not allow change to any field.

Limited allows changes only to selected fields, such as Date and Time.

Full Access allows viewing and changing all the fields in the Setup utility.

Change User Password

Select this item to set or change the user password. The User Password item on top of the screen shows the default **Not Installed**. After you set a password, this item shows **Installed**.

To set a User Password:

1. Select the Change User Password item and press <Enter>.
2. On the password box that appears, type a password composed of at least six letters and/or numbers, then press <Enter>.
3. Confirm the password when prompted.

The message “Password Installed” appears after you set your password successfully.

To change the user password, follow the same steps as in setting a user password.

Clear User Password

Select this item to clear the user password.

Password Check [Setup]

When set to [Setup], BIOS checks for user password when accessing the Setup utility. When set to [Always], BIOS checks for user password both when accessing Setup and booting the system.

Configuration options: [Setup] [Always]

2.7 Exit menu

The Exit menu items allow you to load the optimal or failsafe default values for the BIOS items, and save or discard your changes to the BIOS items.

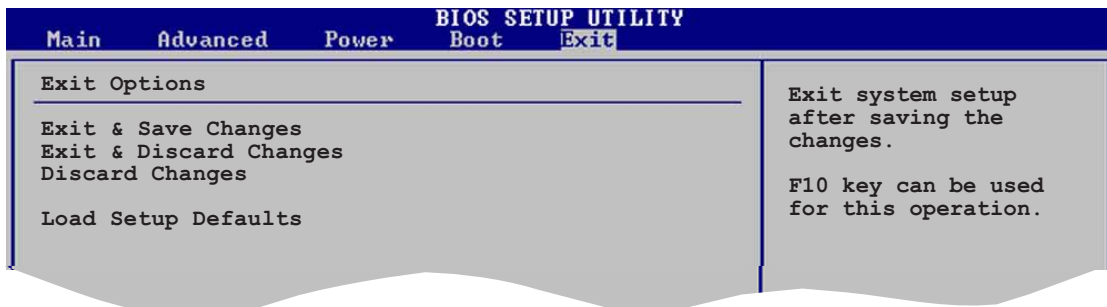

Pressing <Esc> does not immediately exit this menu. Select one of the options from this menu or <F10> from the legend bar to exit.

Exit & Save Changes

Once you are finished making your selections, choose this option from the Exit menu to ensure the values you selected are saved to the CMOS RAM. An onboard backup battery sustains the CMOS RAM so it stays on even when the PC is turned off. When you select this option, a confirmation window appears. Select **Yes** to save changes and exit.



If you attempt to exit the Setup program without saving your changes, the program prompts you with a message asking if you want to save your changes before exiting. Press <Enter> to save the changes while exiting.

Exit & Discard Changes

Select this option only if you do not want to save the changes that you made to the Setup program. If you made changes to fields other than System Date, System Time, and Password, the BIOS asks for a confirmation before exiting.

Discard Changes

This option allows you to discard the selections you made and restore the previously saved values. After selecting this option, a confirmation appears. Select **Yes** to discard any changes and load the previously saved values.

Load Setup Defaults

This option allows you to load the default values for each of the parameters on the Setup menus. When you select this option or if you press <F5>, a confirmation window appears. Select **Yes** to load default values. Select **Exit & Save Changes** or make other changes before saving the values to the non-volatile RAM.

