

P4GE-MX

User Guide



Motherboard

E1722

First Edition

August 2004

Copyright © 2004 ASUSTeK COMPUTER INC. All Rights Reserved.

No part of this manual, including the products and software described in it, may be reproduced, transmitted, transcribed, stored in a retrieval system, or translated into any language in any form or by any means, except documentation kept by the purchaser for backup purposes, without the express written permission of ASUSTeK COMPUTER INC. ("ASUS").

Product warranty or service will not be extended if: (1) the product is repaired, modified or altered, unless such repair, modification or alteration is authorized in writing by ASUS; or (2) the serial number of the product is defaced or missing.

ASUS PROVIDES THIS MANUAL "AS IS" WITHOUT WARRANTY OF ANY KIND, EITHER EXPRESS OR IMPLIED, INCLUDING BUT NOT LIMITED TO THE IMPLIED WARRANTIES OR CONDITIONS OF MERCHANTABILITY OR FITNESS FOR A PARTICULAR PURPOSE. IN NO EVENT SHALL ASUS, ITS DIRECTORS, OFFICERS, EMPLOYEES OR AGENTS BE LIABLE FOR ANY INDIRECT, SPECIAL, INCIDENTAL, OR CONSEQUENTIAL DAMAGES (INCLUDING DAMAGES FOR LOSS OF PROFITS, LOSS OF BUSINESS, LOSS OF USE OR DATA, INTERRUPTION OF BUSINESS AND THE LIKE), EVEN IF ASUS HAS BEEN ADVISED OF THE POSSIBILITY OF SUCH DAMAGES ARISING FROM ANY DEFECT OR ERROR IN THIS MANUAL OR PRODUCT.

SPECIFICATIONS AND INFORMATION CONTAINED IN THIS MANUAL ARE FURNISHED FOR INFORMATIONAL USE ONLY, AND ARE SUBJECT TO CHANGE AT ANY TIME WITHOUT NOTICE, AND SHOULD NOT BE CONSTRUED AS A COMMITMENT BY ASUS. ASUS ASSUMES NO RESPONSIBILITY OR LIABILITY FOR ANY ERRORS OR INACCURACIES THAT MAY APPEAR IN THIS MANUAL, INCLUDING THE PRODUCTS AND SOFTWARE DESCRIBED IN IT.

Products and corporate names appearing in this manual may or may not be registered trademarks or copyrights of their respective companies, and are used only for identification or explanation and to the owners' benefit, without intent to infringe.

Contents

Notices	v
Safety information	vi
About this guide	vii
Conventions used in this guide	vii
Typography	vii
P4GE-MX specifications summary	viii

Chapter 1: Product introduction

1.1 Welcome!	1-2
1.2 Package contents	1-2
1.3 Special features	1-3
1.3.1 Product Highlights	1-3
1.3.2 Unique ASUS features	1-4
1.4 Before you proceed	1-5
1.5 Motherboard overview	1-6
1.5.1 Motherboard layout	1-6
1.5.2 Placement direction	1-7
1.5.3 Screw holes	1-7
1.6 Central Processing Unit (CPU)	1-8
1.6.1 Overview	1-8
1.6.2 Installing the CPU	1-9
1.7 System memory	1-10
1.7.1 DIMM sockets location	1-10
1.7.2 Installing a DIMM	1-10
1.8 Expansion slots	1-11
1.8.1 Standard interrupt assignments	1-11
1.8.2 IRQ assignments for this motherboard	1-11
1.8.3 PCI slots	1-12
1.9 Jumpers	1-13
1.10 Connectors	1-15
1.10.1 Rear panel connectors	1-15
1.10.2 Internal connectors	1-16

Contents

Chapter 2: BIOS information

2.1	Managing and updating your BIOS	2-2
2.1.1	Creating a bootable floppy disk	2-2
2.1.2	Updating the BIOS with EZ Flash feature	2-3
2.1.3	Recovering the BIOS with CrashFree BIOS	2-4
2.1.4	ASUS Update	2-6
2.2	BIOS Setup program	2-8
2.2.1	BIOS menu screen	2-9
2.2.2	Menu bar	2-9
2.2.3	Legend bar	2-10
2.2.4	General help	2-10
2.2.5	Sub-menu	2-10
2.2.6	Pop-up window	2-10
2.3	Main menu	2-11
	Primary and Secondary Master/Slave	2-13
2.4	Advanced menu	2-15
2.4.1	Advanced Chipset Features	2-15
2.4.2	Chip Configuration	2-17
2.5	Power menu	2-20
	Hardware Monitor	2-22
2.6	Boot menu	2-23
2.7	Exit menu	2-24

Chapter 3: Software support

3.1	Install an operating system	3-2
3.2	Support CD information	3-2
3.2.1	Running the support CD	3-2
3.2.2	Drivers menu	3-3
3.2.3	Utilities menu	3-3
3.2.4	ASUS Contact Information	3-4
3.3	Audio configuration	3-5

Notices

Federal Communications Commission Statement

This device complies with Part 15 of the FCC Rules. Operation is subject to the following two conditions:

- This device may not cause harmful interference, and
- This device must accept any interference received including interference that may cause undesired operation.



The use of shielded cables for connection of the monitor to the graphics card is required to assure compliance with FCC regulations. Changes or modifications to this unit not expressly approved by the party responsible for compliance could void the user's authority to operate this equipment.

Canadian Department of Communications Statement

This digital apparatus does not exceed the Class B limits for radio noise emissions from digital apparatus set out in the Radio Interference Regulations of the Canadian Department of Communications.

This class B digital apparatus complies with Canadian ICES-003.

Where to find more information

Refer to the following sources for additional information and for product and software updates.

1. ASUS Websites

The ASUS website provides updated information on ASUS hardware and software products. The ASUS websites are listed in the ASUS Contact Information on the inside front cover.

2. Optional Documentation

Your product package may include optional documentation, such as warranty flyers, that may have been added by your dealer. These documents are not part of the standard package.

Safety information

Electrical safety

- To prevent electrical shock hazard, disconnect the power cable from the electrical outlet before relocating the system.
- When adding or removing devices to or from the system, ensure that the power cables for the devices are unplugged before the signal cables are connected. If possible, disconnect all power cables from the existing system before you add a device.
- Before connecting or removing signal cables from the motherboard, ensure that all power cables are unplugged.
- Seek professional assistance before using an adapter or extension cord. These devices could interrupt the grounding circuit.
- Make sure that your power supply is set to the correct voltage in your area. If you are not sure about the voltage of the electrical outlet you are using, contact your local power company.
- If the power supply is broken, do not try to fix it by yourself. Contact a qualified service technician or your retailer.

Operation safety

- Before installing the motherboard and adding devices on it, carefully read all the manuals that came with the package.
- Before using the product, make sure all cables are correctly connected and the power cables are not damaged. If you detect any damage, contact your dealer immediately.
- To avoid short circuits, keep paper clips, screws, and staples away from connectors, slots, sockets and circuitry.
- Avoid dust, humidity, and temperature extremes. Do not place the product in any area where it may become wet.
- Place the product on a stable surface.
- If you encounter technical problems with the product, contact a qualified service technician or your retailer.

About this guide

Conventions used in this guide

To make sure that you perform certain tasks properly, take note of the following symbols used throughout this manual.



WARNING: Information to prevent injury to yourself when trying to complete a task.



CAUTION: Information to prevent damage to the components when trying to complete a task.



IMPORTANT: Information that you **MUST** follow to complete a task.



NOTE: Tips and additional information to aid in completing a task.

Typography

Bold text	Indicates a menu or an item to select.
<i>Italics</i>	Used to emphasize a word or a phrase.
<Key>	Keys enclosed in the less-than and greater-than sign indicates that you must press the enclosed key. Example: <Enter> indicates that you must press the Enter or Return key.
<Multiple key names>	If you must press two or more keys simultaneously, the key names are linked with a plus sign (+). Example: <Ctrl+Alt+D>
Command	Means that you must enter the command exactly as shown. Example: At the DOS prompt, type the command line: FORMAT A: /S

P4GE-MX specifications summary

CPU	Socket 478 for Intel® Pentium® 4 / Celeron® processors Supports Intel® Hyper-Threading Technology
Chipset	Northbridge: Intel® 845GE Southbridge: Intel® ICH4 (FW82801DB)
Front System Bus	533/400 MHz
Memory	2 x 184-pin DDR DIMM sockets for up to 2GB unbuffered non-ECC PC2700/2100/PC1600 SDRAM memory
Expansion slots	1 x AGP 4x slot 3 x PCI slots
Storage	2 x UltraDMA 100/66
Audio	Realtek® ALC655 6-channel CODEC Supports S/PDIF Out interface
LAN	Realtek® RTL8100C integrated 10/100Mbps LAN controller
USB	Maximum of six (6) USB 2.0 ports
Special features	ASUS JumperFree ASUS C.P.R. (CPU Parameter Recall) ASUS CrashFree BIOS 2 ASUS EZ Flash ASUS MyLogo™ STR (Suspend-to-RAM)
Rear Panel I/O	1 x Parallel port 1 x Serial port 1 x VGA port 1 x PS/2 Keyboard port 1 x PS/2 Mouse port 4 x USB 2.0 ports 1 x RJ-45 port Line In, Line Out, Mic ports
Internal I/O connectors	CPU/Chassis fan connectors 20-pin ATX power connector 4-pin auxiliary power connector 1 x USB 2.0 header supports an additional 2 USB 2.0 ports Chassis intrusion connector S/PDIF Out connector IDE LED connector Power LED connector Serial connector CD/AUX audio-in connectors Front panel audio connector

(continued on the next page)

BIOS features	3Mb Flash ROM, Award BIOS, TCAV, PnP, DMI2.0, WfM2.0, SM BIOS 2.3
Industry standard	PCI 2.2, USB 2.0
Form Factor	MicroATX form factor: 9.6 in x 8.6 in
Support CD contents	Device drivers ASUS PC Probe ASUS Live Update Utility Trend Micro™ PC-cillin™ anti-virus software

** Specifications are subject to change without notice.*

Chapter 1

This chapter describes the features of the motherboard. It includes brief descriptions of the motherboard components, and illustrations of the layout, jumper settings, and connectors.

Product introduction

1.1 Welcome!

Thank you for buying the ASUS® P4GE-MX motherboard!

The motherboard delivers a host of new features and latest technologies making it another standout in the long line of ASUS quality motherboards!

The motherboard combines the powers of the Intel® Pentium® 4 processor and the Intel® 845GE chipset to set a new benchmark for an effective desktop platform solution.

Supporting up to 2GB of system memory with PC2700/PC2100/PC1600 DDR SDRAM, high-resolution graphics via the Intel® Extreme Graphics, USB 2.0, and 6-channel audio features, the motherboard takes you ahead in the world of power computing!

Before you start installing the motherboard, and hardware devices on it, check the items in your package with the list below.

1.2 Package contents

Check your motherboard package for the following items.

- ✓ ASUS P4GE-MX motherboard
- ✓ ASUS motherboard support CD
- ✓ 1 x IDE cable
- ✓ 1 x Floppy disk cable
- ✓ I/O shield
- ✓ Bag of extra jumper caps
- ✓ User guide



If any of the above items is damaged or missing, contact your retailer.

1.3 Special features

1.3.1 Product Highlights

Latest processor technology



The motherboard comes with a 478-pin surface mount, Zero Insertion Force (ZIF) socket for the Intel® Pentium® 4 processor in the 478-pin package with 512/256KB L2 cache on 0.13 or 0.09 micron process. This motherboard supports 533/400 MHz system front side bus that allows 4.3GB/s and 3.2GB/s data transfer rates, respectively. The motherboard also supports the Intel® Hyper-Threading Technology.

Onboard 10/100 LAN



The Realtek® RTL8100C PCI LAN controller provides easy implementation of 10/100 Mbps Fast Ethernet LAN.

Integrated Graphics



The Intel® 845GE chipset delivers realistic 3D/2D graphics with sharp images, fast rendering, smooth motion, and clearly defined details.

AGP 4X support

This Accelerated Graphics Port (AGP) slot supports 1.5V AGP 4x mode graphics cards for 3D graphical applications.

6 USB 2.0 ports



The motherboard implements the new Universal Serial Bus (USB) 2.0 specification, extending the connection speed from 12 Mbps on USB 1.1 to a fast 480 Mbps on USB 2.0 - supporting up to eight USB 2.0 ports. The higher bandwidth of USB 2.0 allows connection of devices such as high resolution video conferencing cameras, next generation scanners and printers, and fast storage units. USB 2.0 is backward compatible with USB 1.1.

6-Channel Audio solution



Onboard is the Realtek® ALC655 AC'97 CODEC. This CODEC provides high-quality 6-channel audio, S/PDIF out support and connector sensing function without having to buy advanced sound cards.

S/PDIF out



The motherboard supports S/PDIF-out function turns your computer into a high-end entertainment system with digital connectivity to powerful speaker systems.

1.3.2 Unique ASUS features

CrashFree BIOS 2

This feature allows you to restore the original BIOS data from the motherboard support CD or a bootable floppy disk in case the BIOS codes and data are corrupted. This protection eliminates the need to buy a replacement ROM chip. See page 2-4.

ASUS EZ Flash BIOS

The ASUS EZ Flash feature works through the Award BIOS Update utility. With EZ Flash, you can easily update the system BIOS even before loading the operating system. See page 2-3.

ASUS MyLogo™

This new feature present in the motherboard allows you to personalize and add style to your system with customizable boot logos. See page 2-23.

C.P.R. (CPU Parameter Recall)

The C.P.R. feature of the motherboard BIOS allows automatic re-setting to the BIOS previous settings in case the system hangs due to overclocking. When the system hangs due to overclocking, C.P.R. eliminates the need to open the system chassis and clear the RTC data. Simply shut down and reboot the system, and BIOS automatically restores the CPU previous setting for each parameter.

1.4 Before you proceed

Take note of the following precautions before you install motherboard components or change any motherboard settings.



1. Unplug the power cord from the wall socket before touching any component.
2. Use a grounded wrist strap or touch a safely grounded object or discharge any static electricity by touching the metal surface of the system chassis.
3. Hold components by the edges to avoid touching the ICs on them.
4. Whenever you uninstall any component, place it on a grounded antistatic pad or in the bag that came with the component.
5. Before you install or remove any component, ensure that the ATX power supply is switched off or the power cord is detached from the power supply. Failure to do so may cause severe damage to the motherboard, peripherals, and/or components.

Onboard LED

The motherboard comes with a stand-by power LED. When lit, this green LED indicates that the system is ON, in sleep mode, or in soft-off mode, a reminder that you should shut down the system and unplug the power cable before removing or plugging in any motherboard component. The illustration below shows the location of the onboard LED.

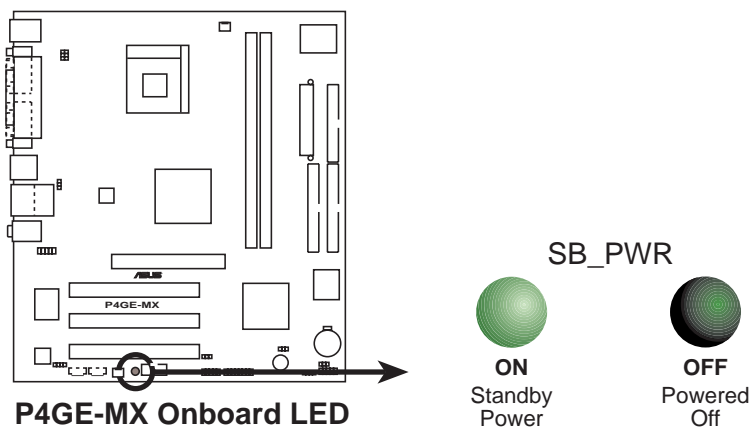

1.5 Motherboard overview

1.5.1 Motherboard layout

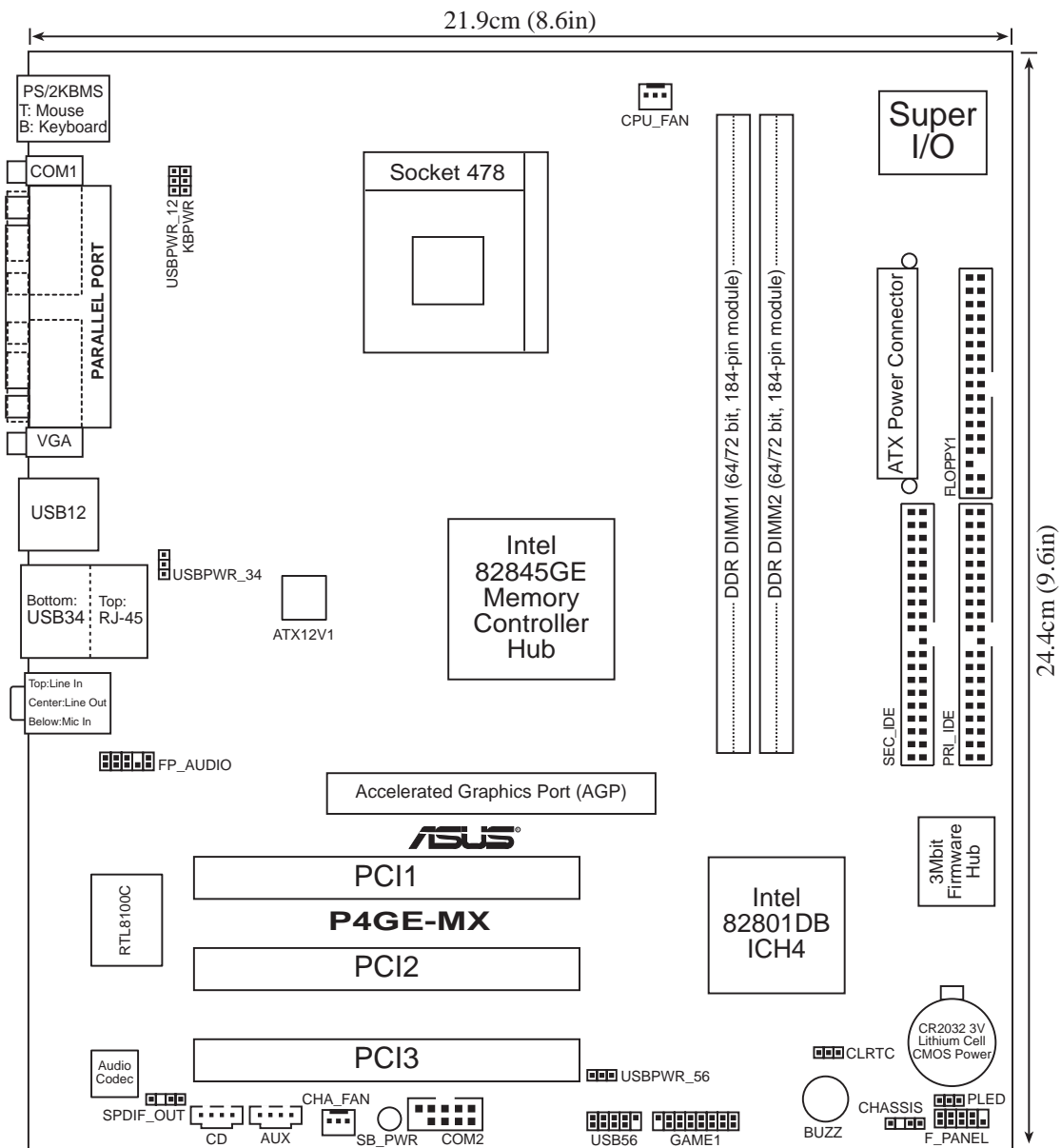

1.5.2 Placement direction

When installing the motherboard, make sure that you place it into the chassis in the correct orientation. The edge with external ports goes to the rear part of the chassis as indicated in the image below.

1.5.3 Screw holes

Place six (6) screws into the holes indicated by circles to secure the motherboard to the chassis.



Do not overtighten the screws! Doing so may damage the motherboard.

Place this side towards
the rear of the chassis

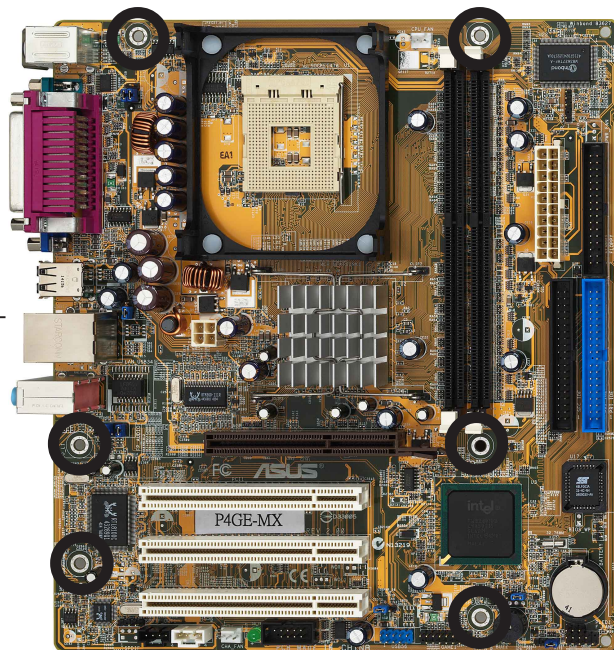

1.6 Central Processing Unit (CPU)

1.6.1 Overview

The motherboard comes with a surface mount 478-pin Zero Insertion Force (ZIF) socket designed for the Intel® Pentium® 4 processor.

Take note of the marked corner (with gold triangle) on the CPU. This mark should match a specific corner on the socket to ensure correct installation.

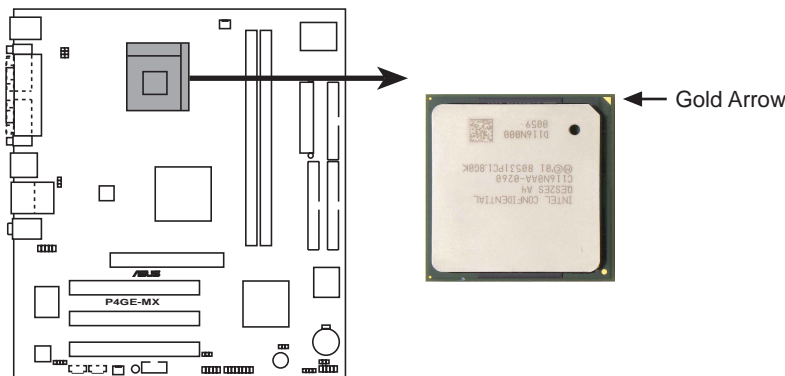

P4GE-MX CPU Socket 478



Incorrect installation of the CPU into the socket may bend the pins and severely damage the CPU!

Notes on Intel® Hyper-Threading Technology



1. This motherboard supports Intel® Pentium® 4 CPUs with Hyper-Threading Technology.
2. Hyper-Threading Technology is supported under Windows® XP and Linux 2.4.x (kernel) and later versions only. Under Linux, use the Hyper-Threading compiler to compile the code. If you are using any other operating systems, disable the Hyper-Threading Technology item in BIOS to ensure system stability and performance.
3. It is recommended that you install Windows® XP Service Pack 1.
4. Make sure to enable the Hyper-Threading Technology item in BIOS before installing a supported operating system.
5. For more information on Hyper-Threading Technology, visit www.intel.com/info/hyperthreading.

1.6.2 Installing the CPU

Follow these steps to install a CPU.

1. Locate the 478-pin ZIF socket on the motherboard.
2. Unlock the socket by pressing the lever sideways, then lift it up to a 90°-100° angle.

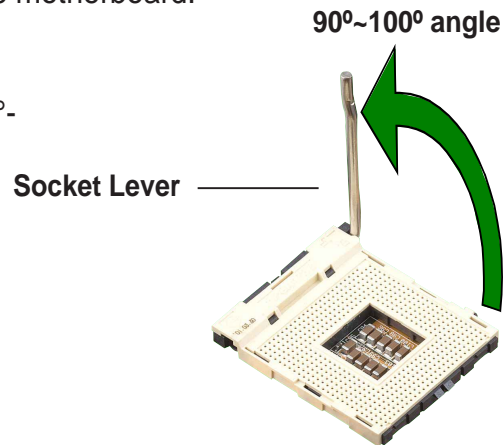

Make sure that the socket lever is lifted up to 90°-100° angle; otherwise, the CPU does not fit in completely.

3. Position the CPU above the socket such that its marked corner matches the base of the socket lever.
4. Carefully insert the CPU into the socket until it fits in place.

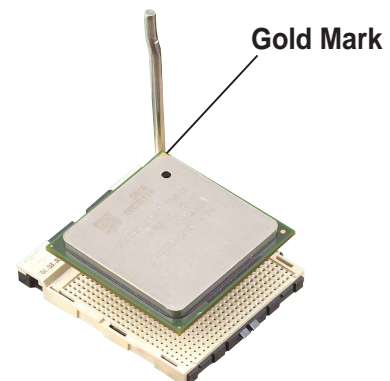

The CPU fits only in one correct orientation. **DO NOT** force the CPU into the socket to prevent bending the pins and damaging the CPU!

5. When the CPU is in place, push down the socket lever to secure the CPU. The lever clicks on the side tab to indicate that it is locked.

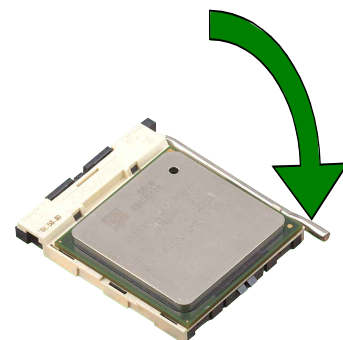

1.7 System memory

1.7.1 DIMM sockets location

You can install 64MB, 256MB, 512MB, and 1GB DDR DIMMs into the DIMM sockets of this motherboard. The following figure illustrates the location of the DDR DIMM sockets.

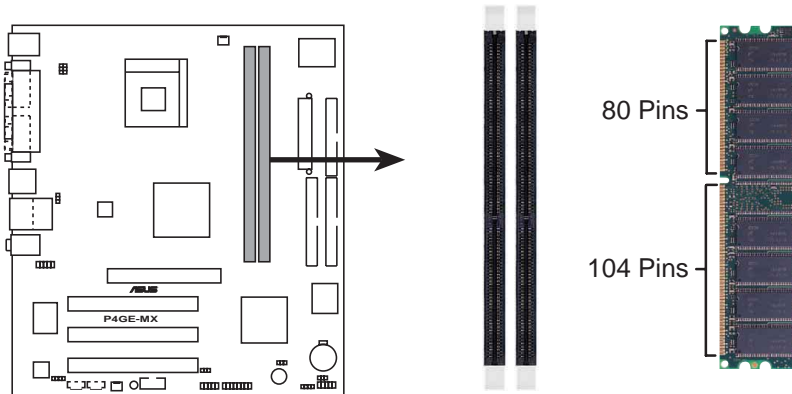

P4GE-MX 184-Pin DDR DIMM Sockets



Make sure to unplug the power supply before adding or removing DIMMs or other system components. Failure to do so may cause severe damage to both the motherboard and the components.

1.7.2 Installing a DIMM

Follow these steps to install a DIMM.

1. Unlock a DIMM socket by pressing the retaining clips outward.
2. Align a DIMM on the socket such that the notch on the DIMM matches the break on the socket.
3. Firmly insert the DIMM into the socket until the retaining clips snap back in place and the DIMM is properly seated.

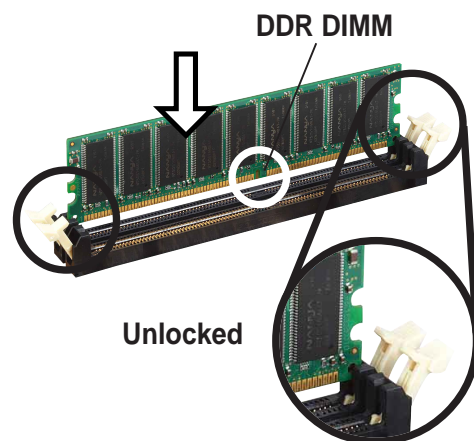

A DDR DIMM is keyed with a notch so that it fits in only one direction. **DO NOT** force a DIMM into a socket to avoid damaging the DIMM.

1.8 Expansion slots

To install and configure an expansion card:

1. Install an expansion card following the instructions that came with the chassis.
2. Turn on the system and change the necessary BIOS settings, if any. See Chapter 2 for BIOS information.
3. Assign an IRQ to the card. Refer to the tables next page.
4. Install the drivers and/or software applications for the expansion card according to the card documentation.

1.8.1 Standard interrupt assignments

IRQ	Standard Function
0	System Timer
1	Keyboard Controller
2	Programmable Interrupt Controller
3	Communications Port (COM2)
4	Communications Port (COM1)
5	IRQ Holder for PCI IRQ Steering
6	Standard Floppy Disk Controller
7	ECP Printer Port (LPT1)
8	System CMOS/Real Time Clock
9	IRQ Holder for PCI IRQ Steering
10	IRQ Holder for PCI IRQ Steering
11	IRQ Holder for PCI IRQ Steering
12	PS/2 Compatible Mouse Port
13	Numeric Data Processor
14	Primary IDE controller (dual fifo)
15	Secondary Ultra ATA Controller (dual fifo)

*These IRQs are usually available for ISA or PCI devices.

1.8.2 IRQ assignments for this motherboard

	A	B	C	D	E	F	G	H
PCI slot 1	—	—	—	—	—	used	—	—
PCI slot 2	—	—	—	—	—	—	used	—
PCI slot 3	—	—	—	—	—	—	—	shared
Onboard USB 1.1 controller 1shared	—	—	—	—	—	—	—	—
Onboard USB 1.1 controller 2	—	—	—	used	—	—	—	—
Onboard USB 1.1 controller 3	—	—	used	—	—	—	—	—
Onboard USB 2.0 controller	—	—	—	—	—	—	—	shared
Onboard LAN	—	shared	—	—	—	—	—	—
Onboard Audio	—	shared	—	—	—	—	—	—
Onboard VGA	shared	—	—	—	—	—	—	—



When using PCI cards on shared slots, ensure that the drivers support “Share IRQ” or that the cards do not need IRQ assignments. Otherwise, conflicts will arise between the two PCI groups, making the system unstable and the card inoperable.

1.8.3 PCI slots

The PCI slots support PCI cards such as a LAN card, SCSI card, USB card, and other cards that comply with PCI specifications.



1.8.4 AGP slot

The Accelerated Graphics Port (AGP) slot supports AGP 4X (+1.5V) cards. When you buy an AGP card, make sure that you ask for one with +1.5V specification.

Note the notches on the card golden fingers to ensure that they fit the AGP slot on the motherboard.



Install only +1.5V AGP cards.

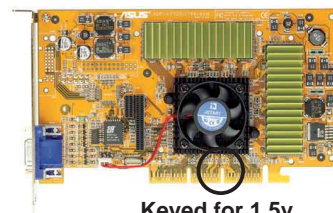
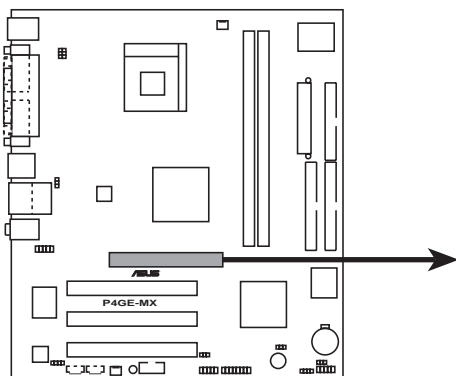

Keyed for 1.5v

P4GE-MX Accelerated Graphics Port (AGP)

1.9 Jumpers

1. Clear RTC RAM (CLRRTC)

This jumper allows you to clear the Real Time Clock (RTC) RAM in CMOS. You can clear the CMOS memory of date, time, and system setup parameters by erasing the CMOS RTC RAM data. The RAM data in CMOS, that include system setup information such as system passwords, is powered by the onboard button cell battery.

To erase the RTC RAM:

1. Turn OFF the computer and unplug the power cord.
2. Move the jumper cap from pins 2-3 (default) to pins 1-2. Keep the cap on pins 1-2 for about 5~10 seconds, then move the cap back to pins 2-3.
3. Plug the power cord and turn ON the computer.
4. Hold down the **** key during the boot process and enter BIOS setup to re-enter data.



Except when clearing the RTC RAM, never remove the cap on the jumper default position. Removing the cap will cause system boot failure!

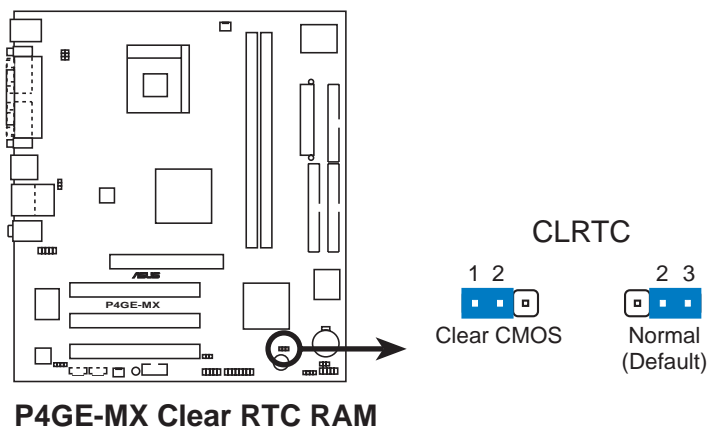

You do not need to clear the RTC when the system hangs due to overclocking. For system failure due to overclocking, use the C.P.R. (CPU Parameter Recall) feature. Shut down and reboot the system so BIOS can automatically reset parameter settings to its previous values.

2. Keyboard power (3-pin KBPWR)

This jumper allows you to enable or disable the keyboard wake-up feature. Set this jumper to pins 2-3 (+5V) if you wish to wake up the computer when you press a key on the keyboard. This feature requires an ATX power supply that can supply at least 1A on the +5V lead, and a corresponding setting in the BIOS.

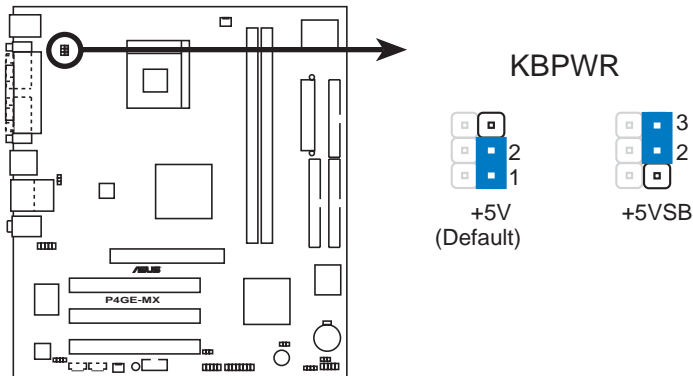

P4GE-MX Keyboard power setting

3. USB device wake-up (3-pin USBPWR_12, USBPWR_34, USBPWR_56)

Set these jumpers to +5V to wake up the computer from S1 sleep mode (CPU stopped, DRAM refreshed, system running in low power mode) using the connected USB devices. Set to +5VSB to wake up from S3 and S4 sleep modes (no power to CPU, DRAM in slow refresh, power supply in reduced power mode).

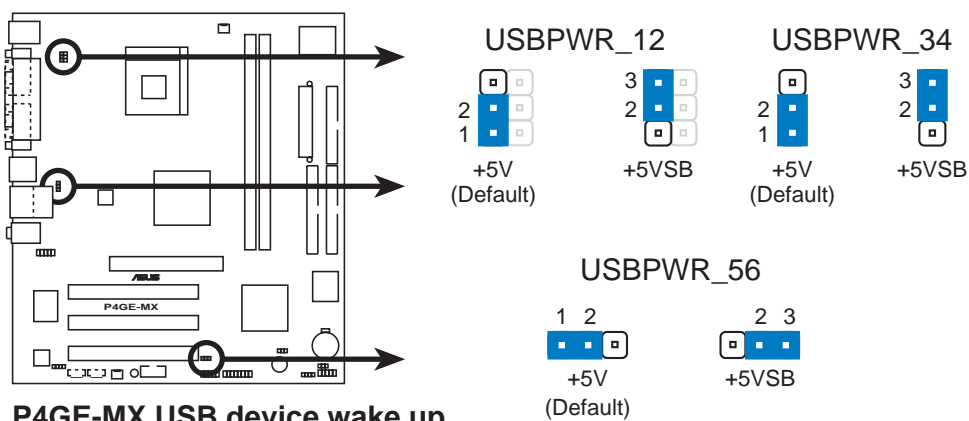

P4GE-MX USB device wake up



- The USB device wake-up feature requires a power supply that can provide 500mA on the +5VSB lead for each USB port. Otherwise, the system would not power up.
- The total current consumed must NOT exceed the power supply capability (+5VSB) whether under normal condition or in sleep mode.

1.10 Connectors

This section describes and illustrates the motherboard rear panel and internal connectors.

1.10.1 Rear panel connectors

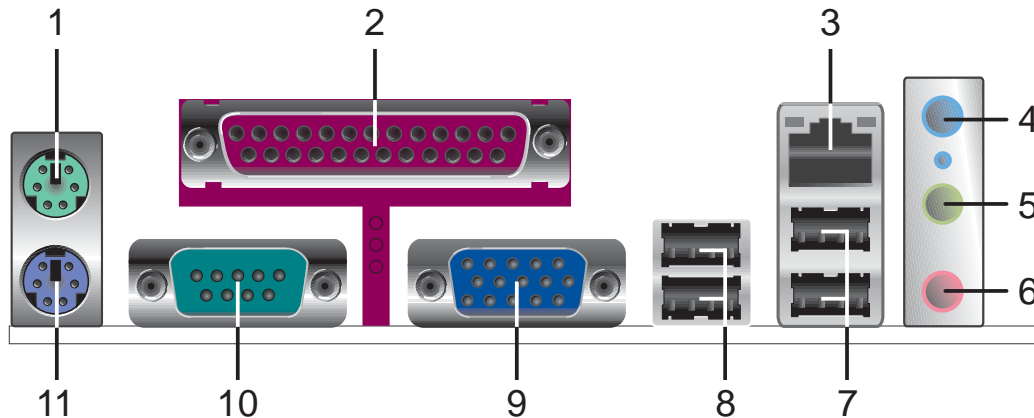

1. **PS/2 mouse port.** This green 6-pin connector is for a PS/2 mouse.
2. **Parallel port.** This 25-pin port connects a parallel printer, a scanner, or other devices.
3. **RJ-45 port.** This port allows connection to a Local Area Network (LAN) through a network hub.
4. **Line In jack.** This Line In (light blue) jack connects a tape player or other audio sources. In 6-channel mode, the function of this jack becomes Bass/Center.
5. **Line Out jack.** This Line Out (lime) jack connects a headphone or a speaker. In 6-channel mode, the function of this jack becomes Front Speaker Out.
6. **Microphone jack.** This Mic (pink) jack connects a microphone. In 6-channel mode, the function of this jack becomes Rear Speaker Out.



The functions of the Line Out, Line In, and Microphone jacks change when you select the 6-channel audio configuration as shown in the following table.

Audio 2, 4 or 6-channel configuration

	Headphone/ 2-Speaker	4-Speaker	6-Speaker
Light Blue	Line In	Line In	Bass/Center
Lime	Line Out	Front Speaker Out	Front Speaker Out
Pink	Mic In	Rear Speaker Out	Rear Speaker Out

7. **USB 2.0 ports 3 and 4.** These two 4-pin Universal Serial Bus (USB) ports are available for connecting USB 2.0 devices.
8. **USB 2.0 ports 1 and 2.** These two 4-pin Universal Serial Bus (USB) ports are available for connecting USB 2.0 devices.
9. **VGA port.** This port connects to a VGA monitor.
10. **Serial connector.** This port connects to your serial mouse and other serial devices.
11. **PS/2 keyboard port.** This purple connector is for a PS/2 keyboard.

1.10.2 Internal connectors

1. IDE connectors (40-1 pin PRI_IDE, SEC_IDE)

This connector supports the provided Ultra DMA 100/66 IDE hard disk ribbon cable. Connect the cable's blue connector to the primary (recommended) or secondary IDE connector, then connect the gray connector to the Ultra DMA 100/66 slave device (hard disk drive) and the black connector to the Ultra DMA 100/66 master device.



- Follow the hard disk drive documentation when setting the device in master or slave mode.
- Pin 20 on each IDE connector is removed to match the covered hole on the Ultra DMA cable connector. This prevents incorrect orientation when you connect the cables.
- The hole near the blue connector on the Ultra DMA cable is intentional.

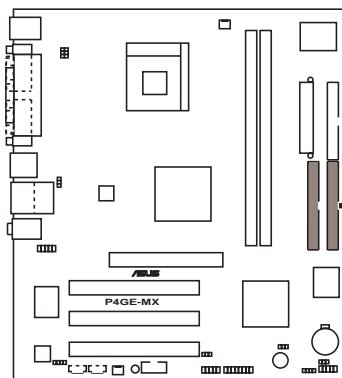

P4GE-MX IDE connectors

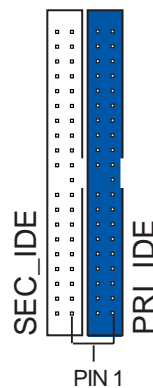

NOTE: Orient the red markings (usually zigzag) on the IDE ribbon cable to PIN 1.

2. Floppy disk drive connector (34-1 pin FLOPPY1)

This connector supports the provided floppy drive ribbon cable. After connecting one end to the motherboard, connect the other end to the floppy drive. (Pin 5 is removed to prevent incorrect insertion when using ribbon cables with pin 5 plug).

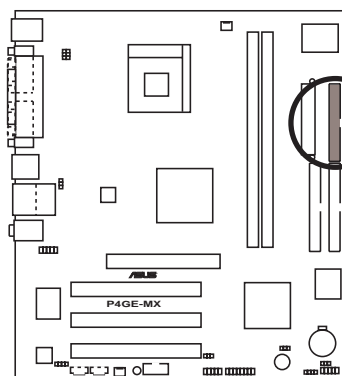

P4GE-MX Floppy disk drive connector

FLOPPY1



NOTE: Orient the red markings on the floppy ribbon cable to PIN 1.

3. ATX power connectors (20-pin ATX_POWER1, 4-pin ATX12V1)

These connectors connect to an ATX 12V power supply. The plugs from the power supply are designed to fit these connectors in only one orientation. Find the proper orientation and push down firmly until the connectors completely fit.

In addition to the 20-pin ATX power connector, this motherboard requires that you connect the 4-pin ATX +12V power plug to provide sufficient power to the CPU.

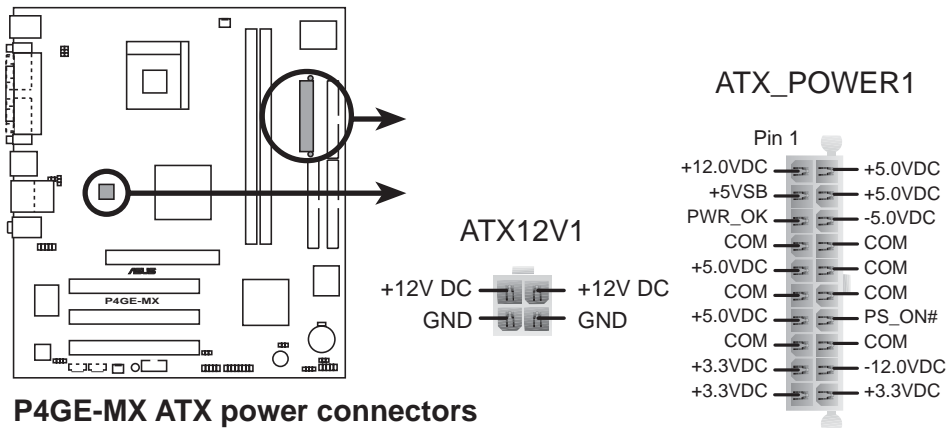

Make sure that your ATX 12V power supply can provide 8A on the +12V lead and at least 1A on the +5-volt standby lead (+5VSB). The minimum recommended wattage is 230W, or 300W for a fully configured system. The system may become unstable and may experience difficulty powering up if the power supply is inadequate.

4. Internal audio connectors (4-pin CD, AUX)

These connectors allow you to receive stereo audio input from sound sources such as a CD-ROM, TV tuner, or MPEG card.

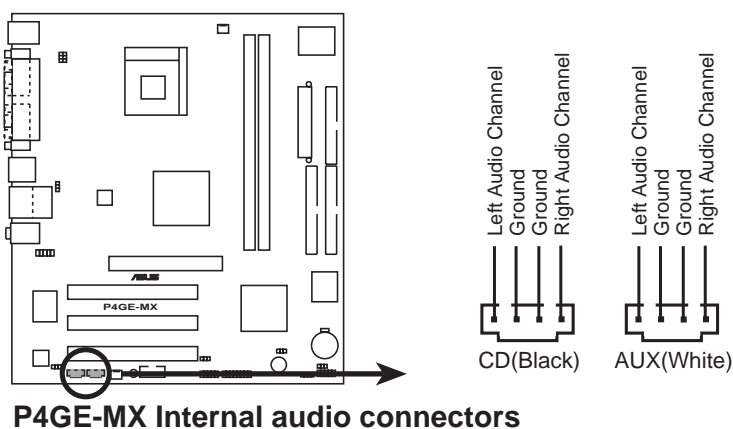

5. CPU and chassis fan connectors (3-pin CPU_FAN, CHA_FAN)

The fan connectors support cooling fans of 350mA~740mA (8.88W max.) or a total of 1A~2.22A (26.64W max.) at +12V. Connect the fan cables to the fan connectors on the motherboard, making sure that the black wire of each cable matches the ground pin of the connector.

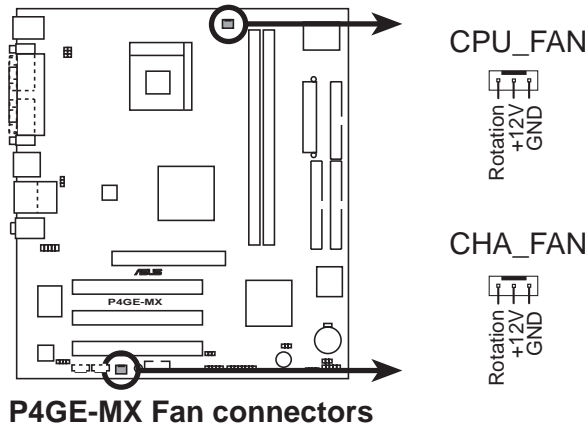

Do not forget to connect the fan cables to the fan connectors. Lack of sufficient air flow within the system may damage the motherboard components. These are not jumpers! DO NOT place jumper caps on the fan connectors!

6. USB header (10-1 pin USB56)

If the USB ports on the rear panel are inadequate, a USB header is available for additional USB ports. Connect the USB cable of the USB 2.0 module to this header. You may install the USB module in the chassis front panel. The module has two USB 2.0 ports for connecting next generation USB peripherals such as high resolution cameras, scanners, and printers.

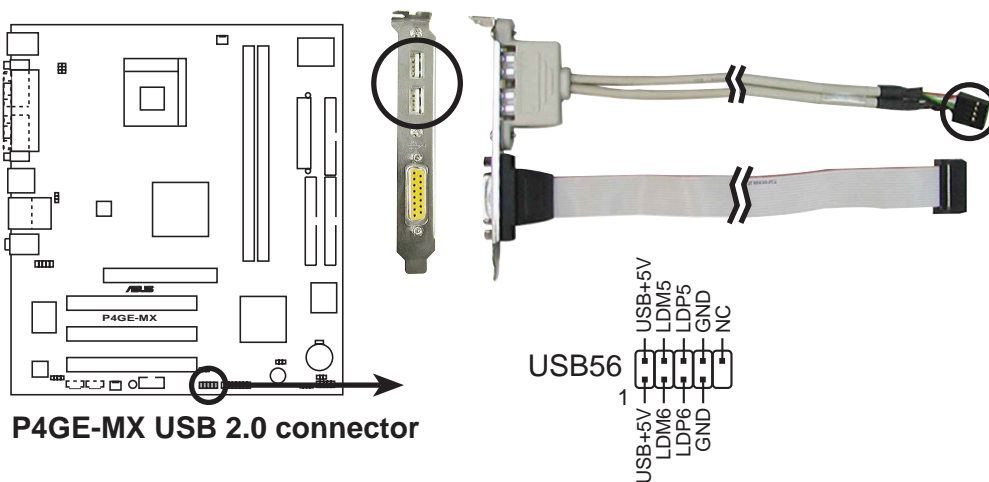

- The USB 2.0 module is purchased separately.
- Install the USB 2.0 driver before using the USB 2.0 feature.

7. Front panel audio connector (10-1 pin FP_AUDIO)

This is an interface for the front panel cable that allows convenient connection and control of audio devices.

By default, the pins labeled LINE OUT_R/BLINE_OUT_R and the pins LINE OUT_L/BLINE_OUT_L are shorted with jumper caps. Remove the caps only when you are connecting the front panel audio cable.

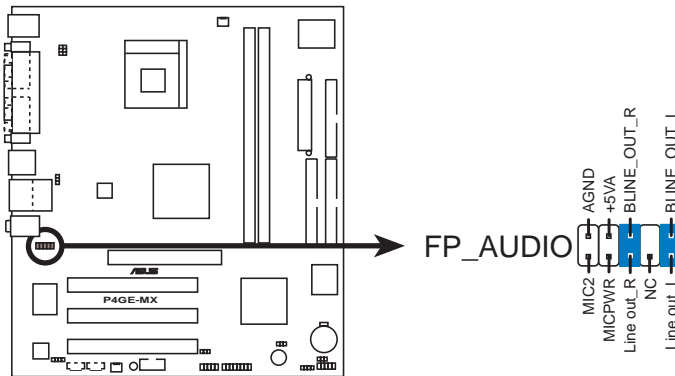

P4GE-MX Front panel audio connector

8. Chassis intrusion connector (4-1 pin CHASSIS1)

This lead is for a chassis designed with intrusion detection feature. This requires an external detection mechanism such as a chassis intrusion sensor or microswitch. When you remove any chassis component, the sensor triggers and sends a high-level signal to this lead to record a chassis intrusion event.

By default, the pins labeled “Chassis Signal” and “Ground” are shorted with a jumper cap. If you wish to use the chassis intrusion detection feature, remove the jumper cap from the pins.

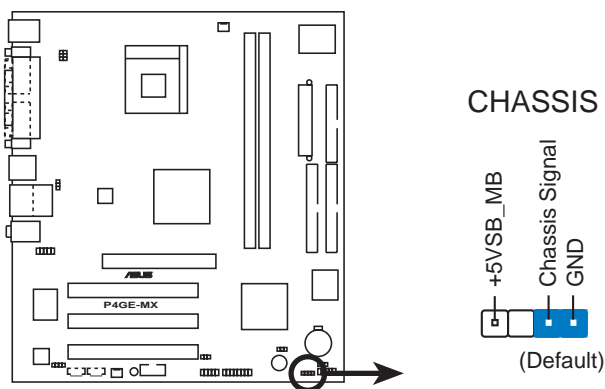

P4GE-MX Chassis intrusion connector

9. GAME/MIDI connector (16-1 pin GAME1)

This connector supports a GAME/MIDI module. If a GAME/MIDI module is available, connect the GAME/MIDI cable to this connector. The GAME/MIDI port on the module connects a joystick or a game pad for playing games, and MIDI devices for playing or editing audio files.

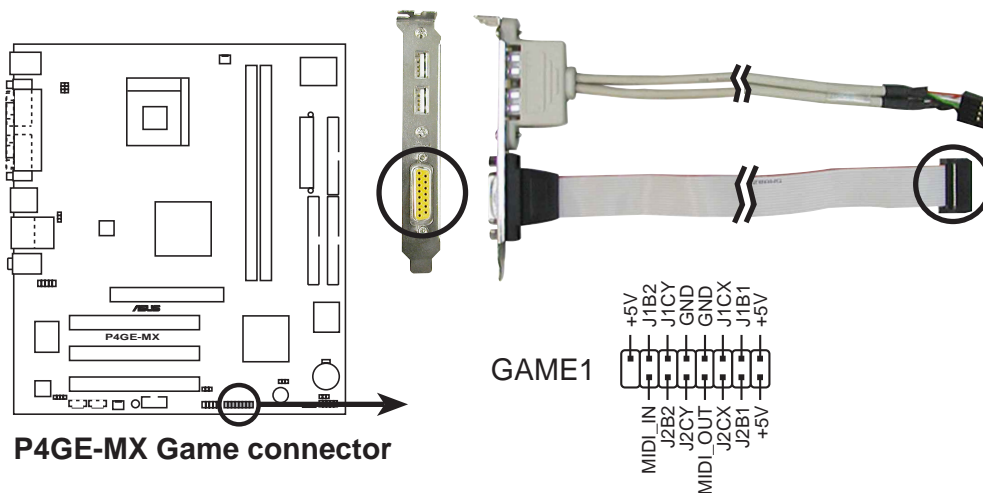

The GAME/MIDI module is purchased separately.

10. Digital Audio connector (6-1 pin SPDIF_OUT)

This connector is for the S/PDIF audio module to allow digital sound output. Connect one end of the S/PDIF audio cable to this connector and the other end to the S/PDIF module.

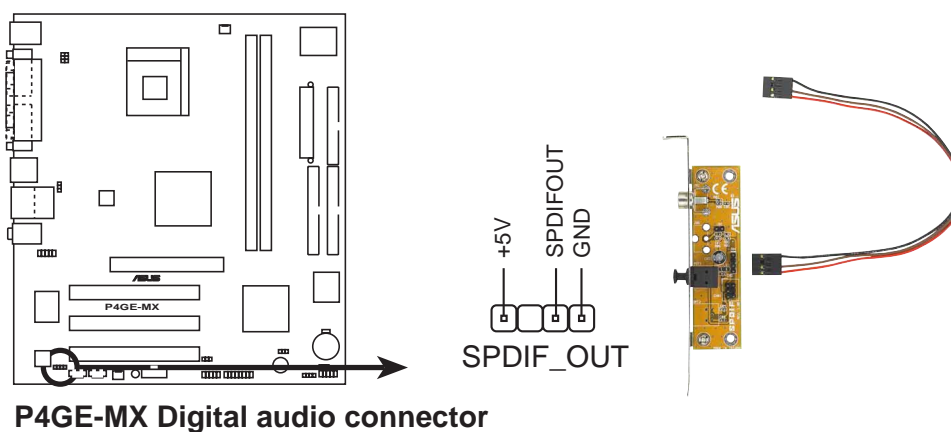

The S/PDIF out module is purchased separately.

11. Serial connector (9-pin COM2)

This 9-pin connector connects to a COM2 bracket. Connect the COM2 cable to this connector and install the bracket on an available slot in the rear panel of the chassis.

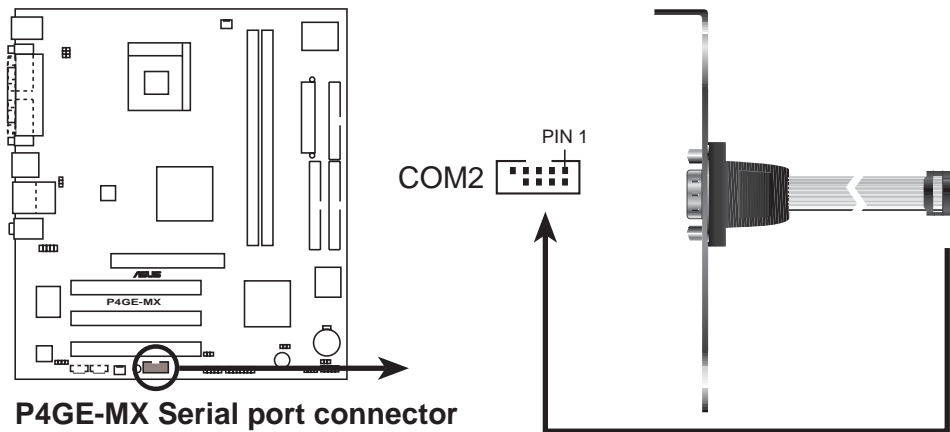

The COM2 bracket is purchased separately.

12. Power LED connector (3-pin PLED1)

This 3-pin connector connects to a 3-pin system power LED. The LED lights up when you turn on the system power.

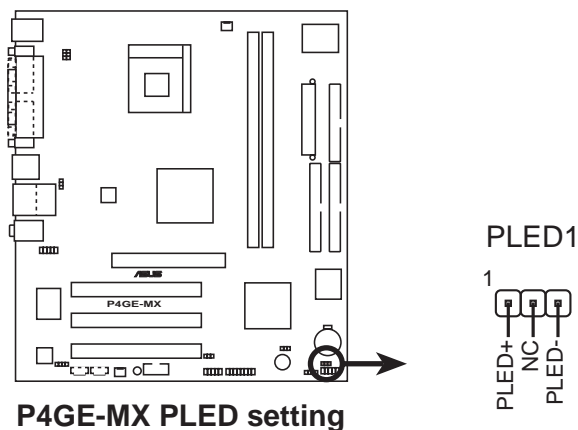

13. System panel connector (10-1 pin F_PANEL)

This connector accommodates several system front panel functions.

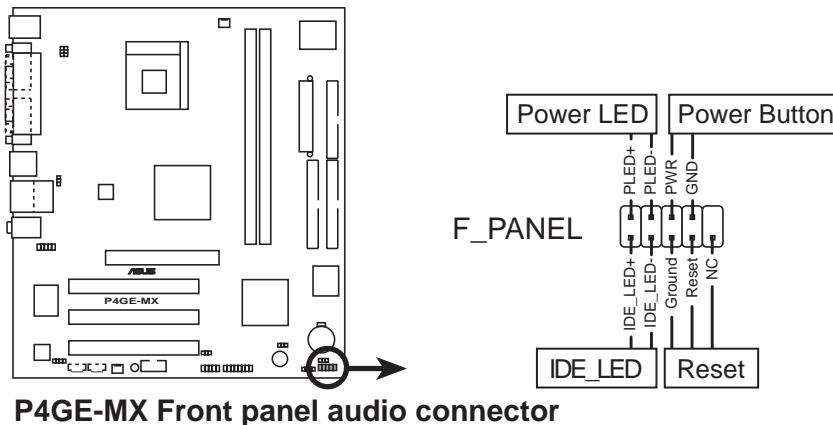

- **System Power LED Lead (2-pin PLED)**

This 2-pin connector connects to the system power LED. The LED lights up when you turn on the system power.

- **ATX Power Switch / Soft-Off Switch Lead (2-pin PWR)**

This connector connects a switch that controls the system power. Pressing the power switch turns the system between ON and SLEEP, or ON and SOFT OFF, depending on the BIOS or OS settings. Pressing the power switch while in the ON mode for more than 4 seconds turns the system OFF.

- **Reset Switch (2-pin RESET)**

This 2-pin connector connects to the case-mounted reset switch for rebooting the system without turning off the power switch.

- **Hard Disk Activity Lead (Red 2-pin IDE_LED)**

This connector supplies power to the hard disk activity LED. The read or write activities of any device connected to the primary or secondary IDE connector cause this LED to light up.

Chapter 2

This chapter tells how to change system settings through the BIOS Setup menus. Detailed descriptions of the BIOS parameters are also provided.

BIOS information

2.1 Managing and updating your BIOS

The following utilities allow you to manage and update the motherboard Basic Input/Output System (BIOS) setup.

1. **AwardBIOS Flash Utility** (*EZ Flash feature that updates the BIOS using a floppy disk during POST.*)
2. **ASUS CrashFree BIOS** (*Updates the BIOS using a bootable floppy disk when the BIOS gets corrupted.*)
3. **ASUS Update** (*Updates the BIOS in Windows® environment.*)

Refer to the corresponding section for details on these utilities.

Important notes



-
- It is recommended that you save a copy of the **original motherboard BIOS file** to a **bootable floppy disk** in case you need to restore the BIOS in the future. Copy the original motherboard BIOS using the ASUS Update or AFLASH utilities.
 - A **working BIOS file** for this motherboard is in the support CD. Use this file only when you do not have a copy of the original motherboard BIOS file in a floppy disk.
 - Visit the ASUS website and download the latest BIOS file for this motherboard using the ASUS Update utility.
-

2.1.1 Creating a bootable floppy disk

1. Do either one of the following to create a bootable floppy disk.

DOS environment

Insert a 1.44 MB floppy disk into the drive. At the DOS prompt, type:

format A:/S then press <Enter>.

Windows® ME environment

- a. From your Windows desktop, click on **Start**, then select **My Computer**.
- b. Double-click on **Add/Remove Programs** icon from the Control Panel window.
- c. Click on the **Startup Disk** tab, then on **Create Disk...** button.
- d. Insert a 1.44 MB floppy disk when prompted. Follow the succeeding screen instructions to complete the process.

Windows® XP environment

- a. Insert a 1.44 MB floppy disk into the floppy disk drive.
 - b. From your Windows desktop, click on **Start**, then select **My Computer**.
 - c. Select the **3 1/2 Floppy Drive** icon.
 - d. Click **File** from the menu, then select **Format**. A **Format 3 1/2 Floppy Disk** window appears.
 - e. Select **Create an MS-DOS startup disk** from the format options field, then click **Start**.
2. Copy the original (or the latest) motherboard BIOS to the bootable floppy disk.

2.1.2 Updating the BIOS with EZ Flash feature

The Basic Input/Output System (BIOS) can be updated using the built-in Flash Memory Writer utility or using a bootable floppy disk with the executable Flash Memory Writer Utility (AWDFLASH.EXE). Follow these instructions to update the BIOS using this utility.



Save only the updated BIOS file in the floppy disk to avoid loading a wrong BIOS file.

1. Download the latest BIOS file from the ASUS website (www.asus.com). Rename the file to *.BIN and save it to the bootable floppy disk you created earlier.
2. Insert the disk that contains the new BIOS file into the floppy drive.
3. Reboot the computer.
4. Press <Alt + F2> during POST to display the following screen.

```
AwardBIOS Flash Utility V8.24B
(C)Phoenix Technologies Ltd. All Rights Reserved
For KM400-8235-6A6LYA0AC-00  DATE: 05/19/2003
Flash Type - SST-39SF020 /5V
File Name to Program : aw0702.bin

Message: Please Wait!
```

5. AWDFLASH checks the new BIOS file from the floppy disk.

6. After verification, AWDFLASH flashes the new BIOS file. Do not shut down the computer during the flash process.

```
AwardBIOS Flash Utility V8.24B
(C)Phoenix Technologies Ltd. All Rights Reserved

For KM400-8235-6A6LYA0AC-00  DATE: 05/19/2003
Flash Type - SST-39SF020 /5V
File Name to Program : aw0702.bin
Program Flashing Memory

Write OK  No Update  Write Fail

Warning: Don't Turn Off Power Or Reset System!
```

7. After the new BIOS file is copied, the computer returns to POST.

2.1.3 Recovering the BIOS with CrashFree BIOS 2

The CrashFree BIOS 2 auto recovery tool allows you to restore BIOS from the motherboard support CD, or from a floppy disk that contains the BIOS file, in case the current BIOS on the motherboard fails or gets corrupted.



- Prepare the **support CD** that came with the motherboard or a **floppy disk that contains the motherboard BIOS** before proceeding with the BIOS update process.
- If you have saved a copy of the original motherboard BIOS to a bootable floppy disk, you may also use this disk to restore the BIOS. See section “2.1.1 Creating a bootable floppy disk.”

To recover the BIOS from a floppy disk:

1. Boot the system.
2. When a corrupted BIOS is detected, the following screen message appears.

```
Bad BIOS checksum. Starting BIOS recovery...
Checking for floppy...
```

3. Insert a floppy disk that contains the original or the latest BIOS file for this motherboard. If all the necessary files are found in the floppy disk, the BIOS update process continues.



Make sure that the BIOS file in the floppy disk is renamed as “**P4GE-MX.ROM**”.

```
Bad BIOS checksum. Starting BIOS recovery...
Checking for floppy...
Floppy found!
Reading file "P4GE-MX.ROM". Completed.
Start flashing...
```



DO NOT shut down or reset the system while updating the BIOS! Doing so may cause system boot failure!

2. When the BIOS update process is complete, reboot the system.

To recover the BIOS from the support CD:

1. Boot the system.
2. When a corrupted BIOS is detected, the following screen message appears.

```
Bad BIOS checksum. Starting BIOS recovery...
Checking for floppy...
```



If there is no floppy disk found in the drive, the system automatically checks the CD-ROM.

3. Place the support CD in the CD-ROM. The support CD contains the a working BIOS for this motherboard.

```
Bad BIOS checksum. Starting BIOS recovery...
Checking for floppy...
Floppy not found!
Checking for CD-ROM...
CD-ROM found.
Reading file "P4GE-MX.ROM". Completed.
Start flashing...
```



DO NOT shut down or reset the system while updating the BIOS! Doing so may cause system boot failure!

2. When the BIOS update process is complete, reboot the system.



The recovered BIOS may not be the latest BIOS version for this motherboard. Visit ASUS website (www.asus.com) to download the latest BIOS file.

2.1.4 ASUS Update

The ASUS Update is a utility that allows you to update the motherboard BIOS in Windows® environment. This utility is available in the support CD that comes with the motherboard package. ASUS Update requires an Internet connection either through a network or an Internet Service Provider (ISP).

To install ASUS Update:

1. Insert the support CD to the optical drive. The **Drivers** menu appears.
2. Click the **Utilities** tab, then click **Install ASUS Update VX.XX.XX**. See page 5-3 for details for the Utilities menu screen.
3. The ASUS Update utility is copied into your system.

To update the BIOS using the ASUS Update:

1. Launch the utility from the Windows desktop by clicking **Start > Programs > ASUS > ASUSUpdate > ASUSUpdate**. The ASUS Update initial screen appears.

2. Select your desired update method, then click **Next**.

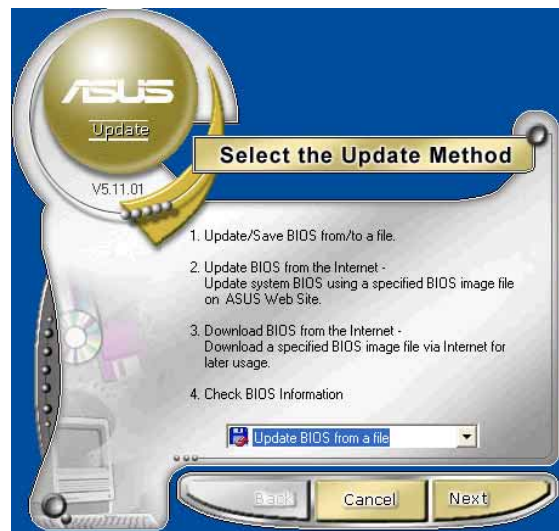

3. If you selected updating/downloading from the Internet, select the ASUS FTP site nearest you to avoid network traffic, or choose **Auto Select**. Click **Next**.

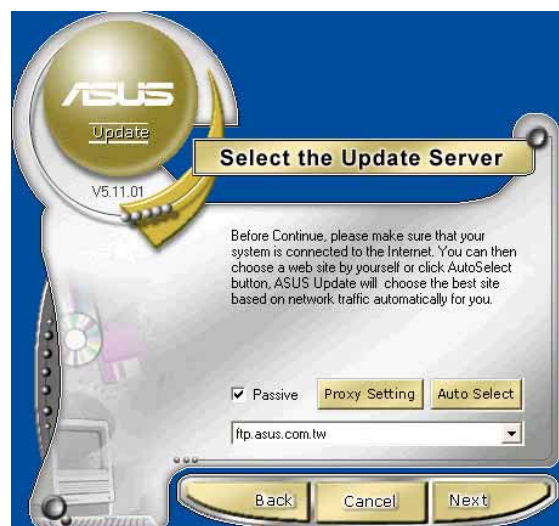

2. From the FTP site, select the BIOS version that you wish to download. Click **Next**.
5. Follow the instructions on the succeeding screens to complete the update process.

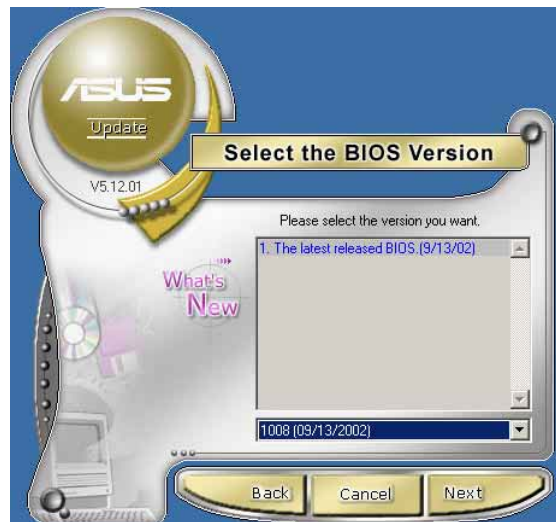

If you selected the option to update the BIOS from a file, a window pops up prompting you to locate the file. Select the file, click **Save**, then follow the screen instructions to complete the update process.

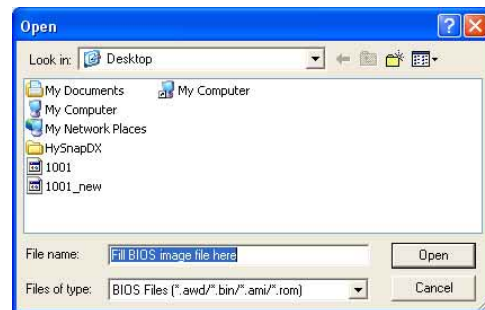

2.2 BIOS Setup program

This motherboard supports a programmable firmware hub (FWH) chip that you can update using the provided utility described in section “2.1 Managing and updating your BIOS.”

Use the BIOS Setup program when you are installing a motherboard, reconfiguring your system, or prompted to “Run Setup”. This section explains how to configure your system using this utility.

Even if you are not prompted to use the Setup program, you may want to change the configuration of your computer in the future. For example, you may want to enable the security password feature or change the power management settings. This requires you to reconfigure your system using the BIOS Setup program so that the computer can recognize these changes and record them in the CMOS RAM of the firmware hub.

The FWH chip on the motherboard stores the Setup utility. When you start up the computer, the system provides you with the opportunity to run this program. Press during the Power-On Self Test (POST) to enter the Setup utility. Otherwise, POST continues with its test routines.

If you wish to enter Setup after POST, restart the system by pressing <Ctrl> + <Alt> + <Delete>, or by pressing the reset button on the system chassis. You can also restart by turning the system off and then back on. Do this last option only if the first two failed.

The Setup program is designed to make it as easy to use as possible. It is a menu-driven program, which means you can scroll through the various sub-menus and make your selections from the available options using the navigation keys.



If the system becomes unstable after changing any BIOS settings, load the default settings to ensure system stability. Select the **Load Optimized Settings** item under the Exit Menu. See section “2.7 Exit menu.”

2.2.1 BIOS menu screen

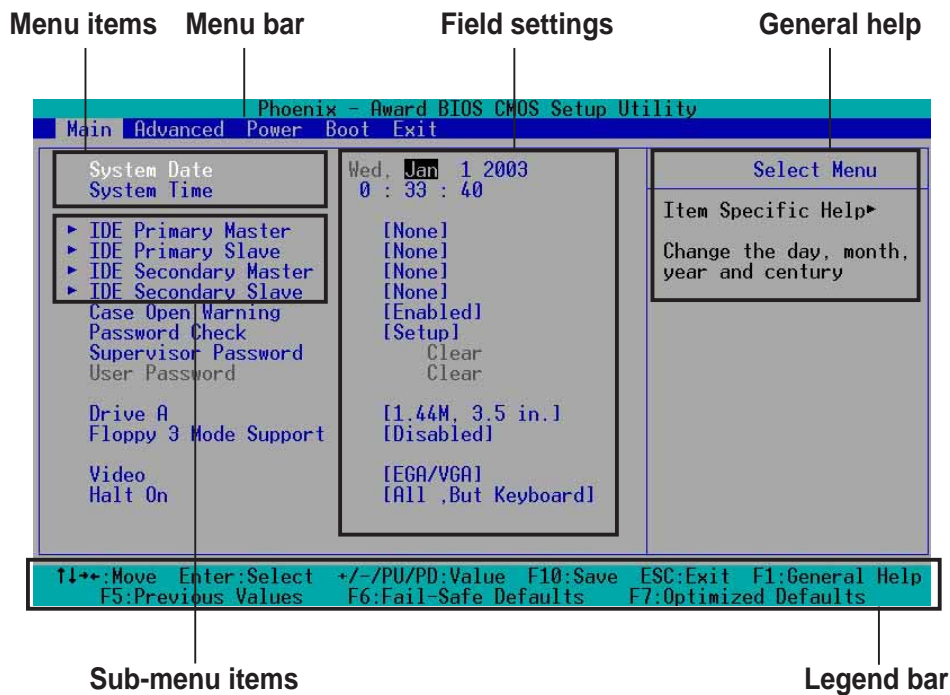

2.2.2 Menu bar

The menu bar on top of the screen has the following main items:

- Main** For changing the basic system configuration
- Advanced** For changing the advanced system settings
- Power** For changing the advanced power management (APM) configuration
- Boot** For changing the system boot configuration
- Exit** For selecting the exit options and loading default settings

To select an item on the menu bar, press the right or left arrow key on the keyboard until the desired item is highlighted.



- The BIOS setup screens shown in this chapter are for reference purposes only, and may not exactly match what you see on your screen.
- Visit the ASUS website (www.asus.com) to download the latest BIOS information.

2.2.3 Legend bar

At the bottom of the Setup screen is a legend bar. The keys in the legend bar allow you to navigate through the various setup menus. The following table lists the keys found in the legend bar with their corresponding functions.

Navigation Key	Function
<F1>	Displays the General Help screen
<F2>	Navigates the Item Specific Help screen
<F5>	Loads previous values
<F6>	Loads fail-safe default values
<F7>	Loads optimized default values
<Esc>	Jumps to the Exit menu or returns to the main menu from a sub-menu
Left or Right arrow	Selects the menu item to the left or right
Up or Down arrow	Moves the highlight up or down between fields
Page Down or – (minus)	Scrolls backward through the values for the highlighted field
Page Up or + (plus)	Scrolls forward through the values for the highlighted field
<Enter>	Brings up a selection menu for the highlighted field
<F10>	Saves changes and exit

2.2.4 General help

On the right side of the menu screen is a brief description of the selected item.

2.2.5 Sub-menu

An item with a sub-menu on any menu screen is distinguished by a solid triangle before the item. To display the sub-menu, select the item and press Enter.

2.2.6 Pop-up window

Select an item in the menu, then press Enter to display a pop-up window with the configuration options for that item.

2.3 Main menu

When you enter the BIOS Setup program, the Main menu screen appears giving you an overview of the basic system information.



Refer to section “2.2.1 BIOS menu screen” for information on the menu screen items and how to navigate through them.

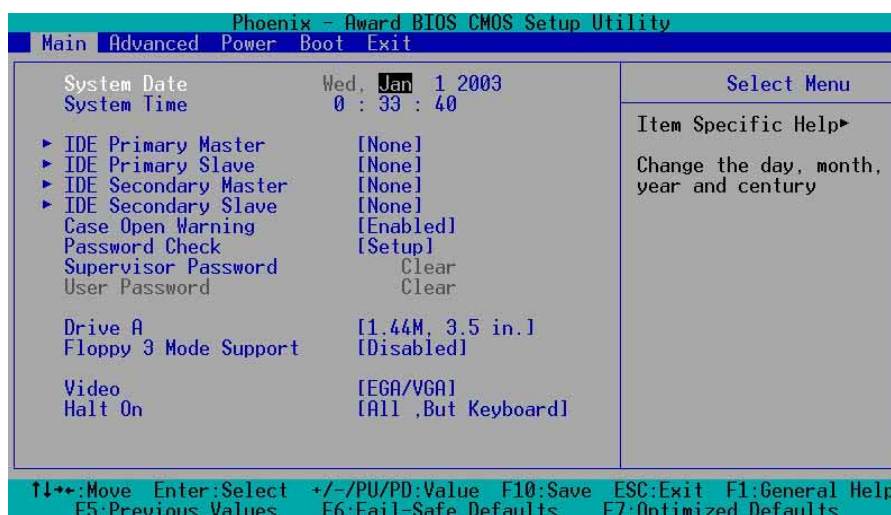

System Date [mm/dd/yy]

Sets the system to the date that you specify (usually the current date). The format is month, day, year. Valid values for month, day, and year are Month: (1 to 12), Day: (1 to 31), Year: (1999 to 2099). Use the <Tab> key to move between the month, day, and year fields. Use the <Page Up> or <Page Down> keys to change the values.

System Time [hh:mm:ss]

Sets the system to the time that you specify (usually the current time). The format is hour, minute, second. Valid values for hour, minute and second are Hour: (00 to 23), Minute: (00 to 59), Second: (00 to 59). Use the <Tab> key to move between the hour, minute, and second fields. Use the <Page Up> or <Page Down> keys to change the values.

Case Open Warning [Enabled]

Enable this option to activate the chassis intrusion feature of the motherboard. Configuration options: [Enabled] [Disabled]

Password Check [Setup]

This field requires users to enter the password before entering the BIOS setup or the system. Select [Setup] to require the password before entering the BIOS Setup. Select [System] to require the password before entering the system. Configuration options: [Setup] [System]

Supervisor Password [Clear] / User Password [Clear]

These fields allow you to set passwords. To set a password, highlight the appropriate field and press <Enter>. Type in a password then press <Enter>. You can type up to eight alphanumeric characters. Symbols and other characters are ignored. To confirm the password, type the password again and press <Enter>. The password field setting is changed to [Set].

To clear the password, highlight this field, and press <Enter>.

A note about passwords

The Supervisor password is required to enter the BIOS Setup program preventing unauthorized access. The User password is required to boot the system preventing unauthorized use.

Forgot the password?

If you forget your password, you can clear it by erasing the CMOS Real Time Clock (RTC) RAM. The RAM data containing the password information is powered by the onboard button cell battery. If you need to erase the CMOS RAM, unplug the all the power cables and remove the button cell battery. Re-install the battery after about 2 seconds, then power up the system. Refer to section "2.6 Jumpers" on page 2-18 for instructions on erasing the CMOS RTC RAM.

Drive A [1.44M, 3.5 in.]

Sets the type of floppy drive installed. Configuration options: [None]
[360K, 5.25 in.] [1.2M , 5.25 in.] [720K , 3.5 in.] [1.44M, 3.5 in.] [2.88M, 3.5 in.]

Floppy 3 Mode Support [Disabled]

Disables or sets the floppy 3 mode support.
Configuration options: [Disabled] [Drive A]

Video [EGA/VGA]

Selects the type of video you want to use.
Configuration options: [EGA/VGA] [CGA 40] [CGA 80] [MONO]

Halt On [All, But Keyboard]

This field sets the system to halt on errors according to the system functions specified in each option. Configuration options: [All Errors] [No Errors]
[All, But Keyboard] [All , But Diskette] [All, But Disk/Key]

Primary and Secondary Master/Slave

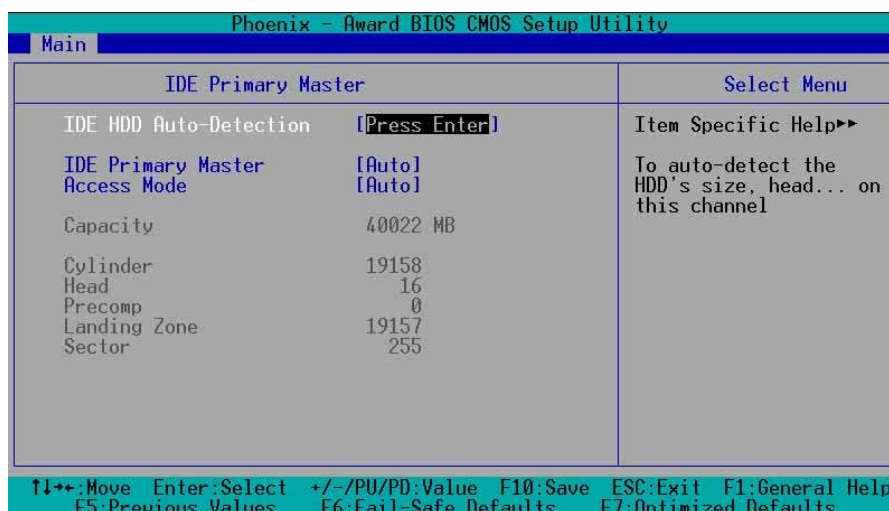

IDE Auto-Detection [Press Enter]

Press enter to automatically detect an IDE hard disk drive, if the hard drive is not already detected. In cases of undetected HDDs, pressing enter detects the HDD and allows you access to the IDE Primary Master and Access Mode fields.

IDE Primary Master/Slave [Auto]; IDE Secondary Master/Slave [Auto]

Select [Auto] to automatically detect an IDE hard disk drive. If automatic detection is successful, the setup BIOS automatically fills in the correct values for the remaining fields on this sub-menu. If automatic detection fails, this may be because the hard disk drive is too old or too new. If the hard disk was already formatted on a previous system, the setup BIOS may detect incorrect parameters. In these cases, select [Manual] to manually enter the IDE hard disk drive parameters. If no drive is installed or if you are removing a drive and not replacing it, select [None]. Configuration options: [None] [Auto] [Manual]

Access Mode [Auto]

The default [Auto] allows automatic detection of an IDE hard disk drive. Select [CHS] for this item if you set the IDE Channel 0/1 Master/Slave to [Manual] to enter the Hard Disk Drive values manually.

Configuration options: [CHS] [LBA] [Large] [Auto]

Manual HDD type selection

If you wish to manually enter the hard disk information, set the IDE Primary Master item to [Manual], and the Access Mode item to [CHS]. To manually enter the number of cylinder, head, and sector per track for the drive, highlight an item, key-in the value that you obtained from the drive documentation then press <Enter>. Refer to the drive documentation or the drive label for this information.

To enter a value, you may also highlight the item, then press <Enter> to display a pop-up menu. Type in the value from the drive documentation, then press <Enter>.



Before attempting to configure a hard disk drive, make sure you have the correct configuration information supplied by the drive manufacturer. Incorrect settings may cause the system to fail to recognize the installed hard disk.

Capacity [xxxxx MB]

This item displays the auto-detected hard disk capacity. The value is not user-configurable.

Cylinder

This item shows the number of the hard disk cylinders.

Head

This item shows the number of the hard disk read/write heads.

Precomp

This item shows the precomp.

Landing Zone

This item shows the landing zone.

Sector

This item shows the number of sectors per track.



After entering the IDE hard disk drive information into BIOS, use a disk utility, such as FDISK, to partition and format new IDE hard disk drives. This is necessary so that you can write or read data from the hard disk. Make sure to set the partition of the Primary IDE hard disk drives to active.

2.4 Advanced menu

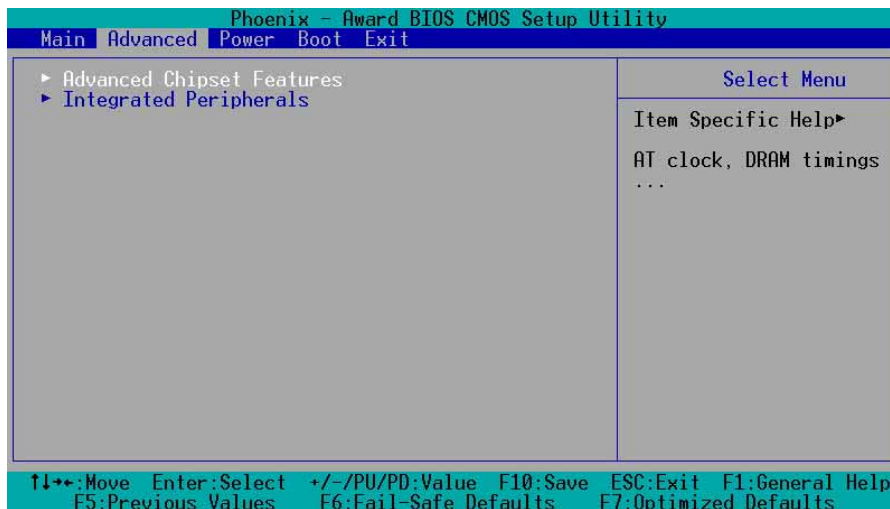

2.4.1 Advanced Chipset Features

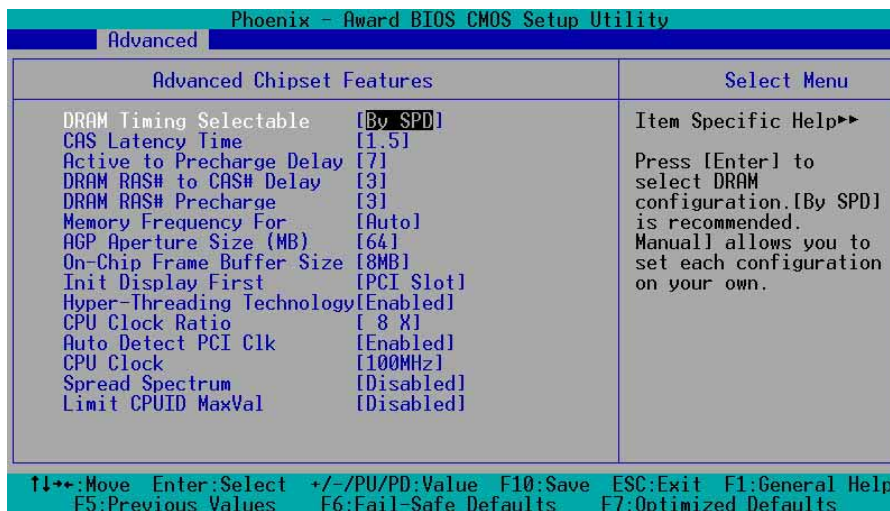

DRAM Timing Selectable [By SPD]

Sets the DRAM Timing configuration. Set to manual if you want to configure each item on your own. Configuration options: [Manual] [By SPD]

CAS Latency Time [1.5]

Sets the latency between the DRAM command and the time the data actually become available. Configuration options: [1.5] [2] [2.5] [3]

Active to Precharge Delay [7]

Controls the number of DRAM clocks used for the DRAM parameters. Configuration options: [7] [6] [5]

DRAM RAS# to CAS# Delay [3]

Sets the latency between the DRAM active command and the R/W command.
Configuration options: [3] [2]

DRAM RAS# Precharge [3]

Sets the idle clocks after issuing a precharge command to the DRAM.
Configuration options: [3] [2]

Memory Frequency for [Auto]

This item allows you set the FSB and system memory frequency. The default setting is [Auto]. Configuration options: [PC100] [PC133] [Auto]

AGP Aperture Size (MB) [64]

Sets the size of the AGP aperture.
Configuration options: [4] [8] [16] [32] [64] [128] [256]

On-Chip Frame Buffer Size [8MB]

Sets the frame buffer size. Configuration options: [1MB] [8MB]

Init Display First [PCI Slot]

Selects which graphics controller to use as the primary boot device.
Configuration options: [PCI slot] [Onboard] [AGP]

Hyper-Threading Technology [Enabled]

Enables or disables the Intel® Hyper-Threading Technology feature.
Configuration options: [Disabled] [Enabled]

CPU Clock Ratio [8 X]

Allows you to key-in the ratio between the CPU core clock and the Front Side Bus (FSB) frequency. To do so, highlight the item then press <Enter> to display a pop-up menu. Enter a value from the specified range, then press Enter. The configuration option values depend on the CPU installed.

Auto Detect PCI Clk [Enabled]

Allows you to disable or enable the auto-detect function of the PCI clock. When enabled, the bus speed is calculated based on the capacity of the device installed.

CPU Clock [100MHz]

This item allows you to set the CPU frequency. To do so, highlight the item then press <Enter> to display a pop-up menu. Enter a value from the specified range, then press Enter. The configuration option values depend on the CPU installed.

Spread Spectrum [Disabled]

This field enables or disables the clock generator spread spectrum.
Configuration options: [Disabled] [+/- 0.25%] [+/- 0.35%] [+/- 0.45%] [- 0.5%]

Limit CPUID MaxVal [Disabled]

Allows you to limit the CPUID maximum value. Set this item to Disabled, if you installed Windows® XP operating system.

2.4.2 Integrated Peripherals

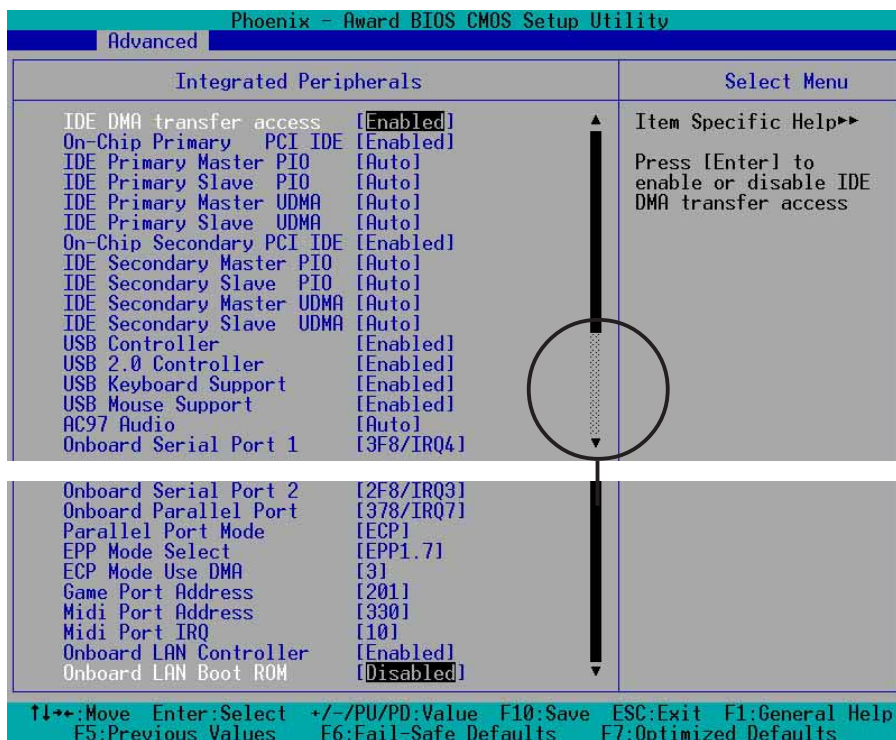

IDE DMA Transfer Access [Enabled]

Disables or enables the IDE DMA transfer access.
Configuration options: [Disabled] [Enabled]

On-Chip Primary PCI IDE [Enabled]

Disables or enables the On-chip Primary PCI IDE support.
Configuration options: [Disabled] [Enabled]

Primary Master PIO [Auto]

Primary Slave PIO [Auto]

Secondary Master PIO [Auto]

Secondary Slave PIO [Auto]

These items allow you to set a PIO (Programmable Input/Output) mode for primary IDE devices. Configuration options: [Auto] [Mode 0] [Mode 1] [Mode 2] [Mode 3] [Mode 4]

On-Chip Secondary PCI IDE [Enabled]

Disables or enables the On-chip Secondary PCI IDE support.
Configuration options: [Disabled] [Enabled]

Primary Master UDMA [Auto]

Primary Slave UDMA [Auto]

Secondary Master UDMA [Auto]

Secondary Slave UDMA [Auto]

These items allow you to automatically set or disable the primary IDE UDMA capability, which improves transfer speeds and data integrity for compatible IDE devices. Configuration options: [Disabled] [Auto]

USB Controller [Enabled]

Disables or enables the USB controller. Configuration options: [Disabled] [Enabled]

USB 2.0 Controller [Enabled]

Disables or enables the USB 2.0 controller.
Configuration options: [Disabled] [Enabled]

USB Keyboard Support [Enabled]

Disables or enables the USB keyboard support.
Configuration options: [Disabled] [Enabled]

USB Mouse Support [Enabled]

Disables or enables the USB mouse support.
Configuration options: [Disabled] [Enabled]

AC97 Audio [Auto]

Disables or set to auto-detect if there are any AC'97-compliant devices installed.
Configuration options: [Disabled] [Auto]

Onboard Serial Port 1 [3F8/IRQ4]

Onboard Serial Port 2 [2F8/IRQ3]

These fields allow you to set the address for the onboard serial connectors.
Configuration options: [Disabled] [3F8/IRQ4] [2F8/1RQ3] [3E8/IRQ4] [2E8/IRQ3] [Auto]

Onboard Parallel Port [378/IRQ7]

This field allows you to set the address of the onboard parallel port connector.
Configuration options: [Disabled] [378/IRQ7] [278/IRQ5] [3BC/IRQ7]

Parallel Port Mode [ECP]

This field allows you to set the operation mode of the parallel port. [SPP] allows normal-speed operation but in one direction only; [EPP] allows bidirectional parallel port operation; [ECP] allows the parallel port to operate in bidirectional DMA mode; [ECP+EPP] allows normal speed operation in a two-way mode. Configuration options: [SPP] [EPP] [ECP] [ECP+EPP] [Normal]

EPP Mode Select [EPP1.7]

Sets the parallel port DMA channel for the selected EPP mode. The default setting is EPP1.7. Configuration options: [EPP1.9] [EPP1.7]

ECP Mode Use DMA [3]

Sets the parallel port DMA channel for the selected ECP mode. The default setting is 3. Configuration options: [1] [3]

Game Port Address [201]

Disables or sets the GAME port address.
Configuration options: [Disabled] [201] [209]

Midi Port Address [330]

Disables or sets the GAME port address.
Configuration options: [Disabled] [330] [300] [290]

Midi Port IRQ [10]

Sets the MIDI port IRQ. Configuration options: [5] [10]

Onboard LAN Controller [Enabled]

Allows you to enable or disable the onboard LAN controller. Configuration options: [Disabled] [Enabled]

Onboard LAN Boot ROM [Disabled]

Allows you to enable or disable the boot ROM of the onboard LAN chip.
Configuration options: [Disabled] [Enabled]

2.5 Power menu

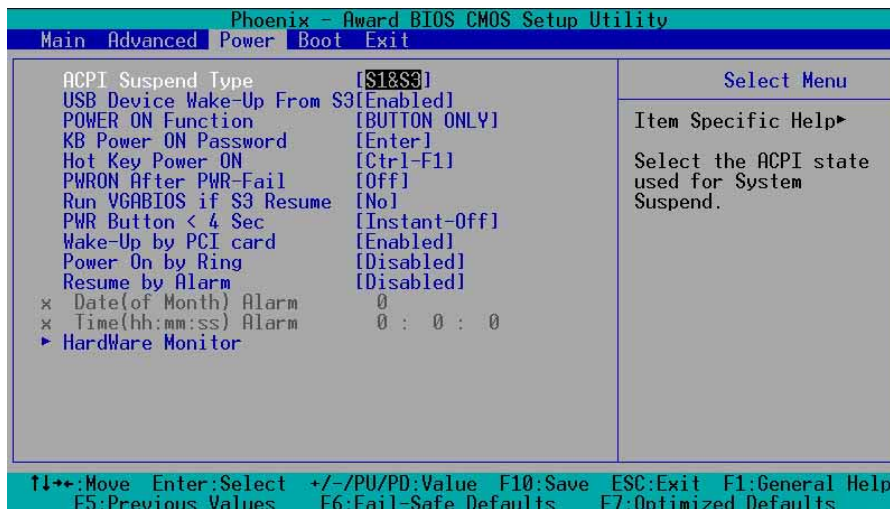

ACPI Suspend Type [S1 & S3]

Allows you to select the ACPI state to used for system suspend.
Configuration options: [S1 (POS)] [S3 (STR)] [S1 & S3]

USB Device Wake-Up From S3 [Enabled]

Disables or enables the USB device wake-up from S3 feature.
Configuration options: [Disabled] [Enabled]

POWER ON Function [BUTTON ONLY]

Allows you to set a button or key to wake up the system.
Configuration options: [Password] [Hot KEY] [Mouse Left] [Mouse Right] [Any KEY] [BUTTON ONLY] [PS/2 Mouse]

KB Power ON Password [Enter]

This item allows you to set or change a password.

To set a password:

1. Set the **POWER ON Function** item as Password.
2. Select **KB Power ON Password** then press <Enter>.
3. From the password box, type a password composed of at least six letters and/or numbers, then press <Enter>
4. Confirm the password when prompted.

To change the password, follow the same steps as in setting a password.

To clear the password, select the KB Power On Password then press <Enter> password. The message "PASSWORD DISABLED!!! Press any key to continue..." appears.

Hot Key Power ON [Ctrl-F1]

Allows you to set a hot-key to wake up the system from sleep mode. To configure this item, make sure that the **Power ON Function** is set as Hot KEY.

Configuration options: [Ctrl-F1] ... [Ctrl-F12]

PWRON After PWR-Fail [Off]

Allows you to set whether the system will reboot after power interruptions.

Configuration options: [Off] [On] [Former-Sts]

Run VGABIOS if S3 Resume [No]

Sets whether to run the VGABIOS after an S3 resume.

Configuration options: [Auto] [Yes] [No]

Power Button < 4 Sec [Instant-Off]

When set to Instant Off, the system will go to soft-off after the power button is pressed for less than 4 seconds. When set to Suspend, the system will go to suspend mode after the power button is press for less than 4 seconds. Press the power button for more than 4 seconds to power-off the system.

Configuration options: [Instant-Off] [Suspend]

Wake-Up by PCI card [Enabled]

Disables or enables the PME to generate a wake event from soft-off mode.

Configuration options: [Disabled] [Enabled]

Power On by Ring [Disabled]

Disables or enables the wake event from soft-off mode when the external modem receives a call. Configuration options: [Disabled] [Enabled]

Resume by Alarm [Disabled]

Allows you to enable or disable RTC to generate a wake event. When this item is enabled, the **Date (of Month) Alarm** and **Time(hh:mm:ss) Alarm** fields are activated for manual setup. Configuration options: [Enabled] [Disabled]

Date (of Month) Alarm [0]

To set the data of alarm, highlight this item and press <Enter> to display a pop-up menu. Key-in a value within the specified range then press <Enter>.

Configuration options: [Min=0] [Max=31]

Time (hh:mm:ss) Alarm [0:0:0]

To set the time of alarm:

1. Highlight this item and press <Enter> to display a pop-up menu for the hour field.
2. Key-in a value (Min=0, Max=23), then press <Enter>.

2. Key-in a value (Min=0, Max=23), then press <Enter>.
3. Press tab to move to the minutes field, then press <Enter>.
4. Key-in a minute value (Min=0, Max=59), then press <Enter>.
5. Press tab to move to the seconds field, the press <Enter>.
6. Key-in a value (Min=0, Max=59), then press <Enter>.

Hardware Monitor



The items in the Hardware Monitor sub-menu displays the status of the hardware devices monitored by the system.

CPU Warning Temperature [Disabled]

Disables or sets the CPU warning temperature.

Configuration options: [Disabled] [50°C/122°F] [53°C/127°F] [56°C/133°F] [60°C/140°F] [63°C/145°F] [66°C/151°F] [70°C/158°F]

MB Temperature [xxx°C]

CPU Temperature [xxx°C]

The onboard hardware monitor automatically detects and displays the motherboard and CPU temperatures.

CPU Fan Speed [xxxxRPM] or [0RPM]

Chassis Fan Speed [xxxxRPM] or [0RPM]

The onboard hardware monitor automatically detects and displays the CPU and chassis fan speeds in rotations per minute (RPM). If any of the fans is not connected to the motherboard, that field shows 0 RPM.

VCore [X.XXV]

+12V [X.XXV]

+3V [X.XXV]

+5V [X.XXV]

5VSB(V)

The onboard hardware monitor automatically detects the voltage output through the onboard voltage regulators.

2.6 Boot menu

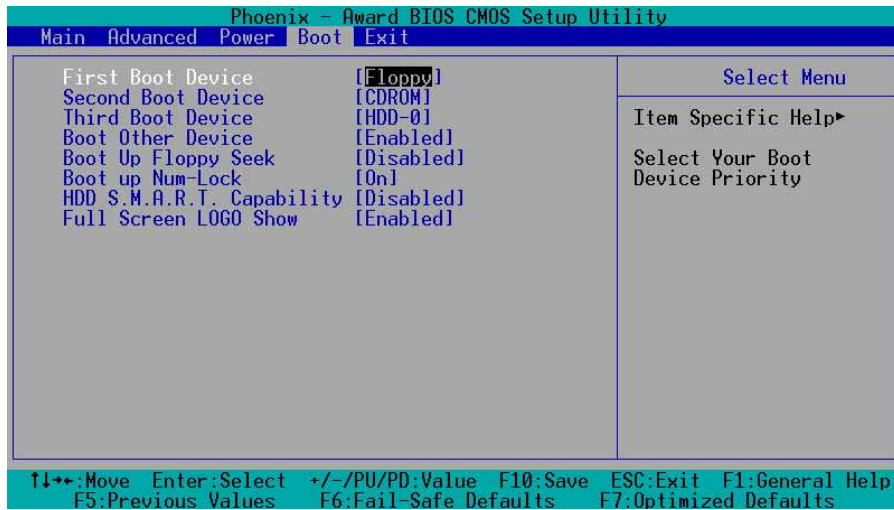

First, Second, Third Boot Device

The Boot Menu allows you to select 13 types of boot devices. Promotion or demotion of devices alters the priority which the system uses to boot device on system power up. Configuration options include [Floppy] [LS120] [HDD-0] [SCSI] [CDROM] [HDD-1] [HDD-2] [HDD-3] [ZIP] [USB-FDD] [USB-ZIP] [USB-CDROM] [USB-HDD] [LAN] [Disabled]

Boot Other Device [Enabled]

Enables or disables boot from other device function.
Configuration options: [Disabled] [Enabled]

Boot Up Floppy Seek [Disabled]

When enabled, the BIOS will seek the floppy disk drive to determine whether the drive has 40 or 80 tracks. Configuration options: [Disabled] [Enabled]

Boot up Num-Lock [On]

Allows you to select the power-on state of the NumLock.
Configuration options: [On] [Off]

HDD S.M.A.R.T. Capability [Disabled]

Enables or disables the Smart Monitoring, Analysis, and Reporting Technology (S.M.A.R.T.) feature. Configuration options: [Disabled] [Enabled]

Full Screen LOGO Show [Enabled]

This allows you to enable or disable the full screen logo display feature.
Configuration options: [Disabled] [Enabled]



Make sure that the Full Screen Logo Show item is set to [Enabled] if you wish to use the ASUS MyLogo™ feature.

2.7 Exit menu

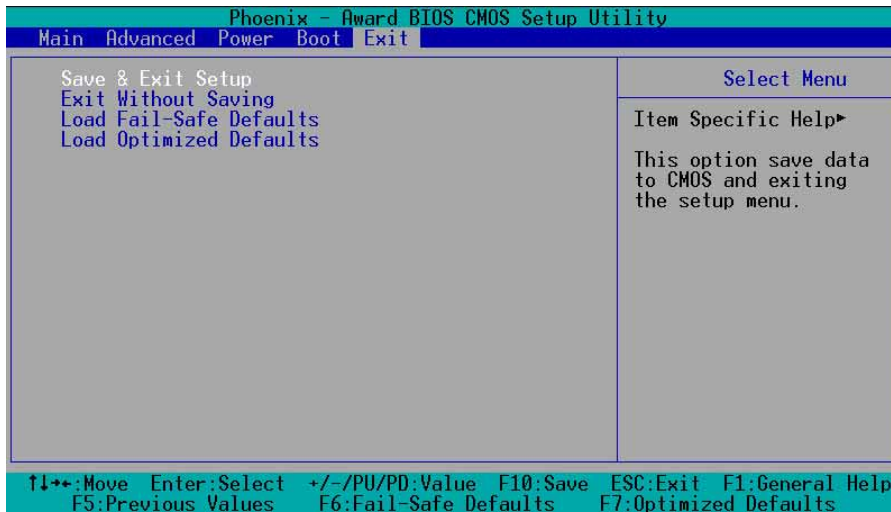

Save & Exit Setup

Once you are finished making your selections, choose this option from the Exit menu to ensure the values you selected are saved to the CMOS RAM. The CMOS RAM is sustained by an onboard backup battery and stays on even when the PC is turned off. When you select this option, a confirmation window appears. Select [Yes] to save changes and exit.

Exit Without Saving

Select this option if you do not want to save the changes you made to the Setup program. If you made changes to other fields other than system date, time, and password, the BIOS asks for a confirmation before you exit the BIOS Setup.

Load Fail-Safe Defaults

This option allows you to load the fail-safe values for each of the parameters on the Setup menus. When you select this option or if you press <F6>, a confirmation window appears. Press <Y> to load fail-safe values. Select Save & Exit or make other changes before saving the values to the non-volatile RAM.

Load Optimized Defaults

This option allows you to load the optimized values for each of the parameters on the Setup menus. When you select this option or if you press <F7>, a confirmation window appears. Press <Y> to load optimized values. Select Save & Exit or make other changes before saving the values to the non-volatile RAM.

Chapter 3

This chapter describes the contents of the support CD that comes with the motherboard package.

Software support

3.1 Install an operating system

This motherboard supports Windows® 98SE/ME/2000/XP operating system (OS). Always install the latest OS version and corresponding updates to maximize the features of your hardware.



Motherboard settings and hardware options vary, so use the setup procedures presented in this chapter for general reference only. Refer to your OS documentation for more information.

3.2 Support CD information

The support CD that came with the motherboard contains useful software and several utility drivers that enhance the motherboard features.



The contents of the support CD are subject to change at any time without notice. Visit the ASUS website for updates.

3.2.1 Running the support CD

To begin using the support CD, simply insert the CD into your CD-ROM drive. The CD automatically displays the **Drivers** menu if Autorun is enabled in your computer. Click on an item to install.

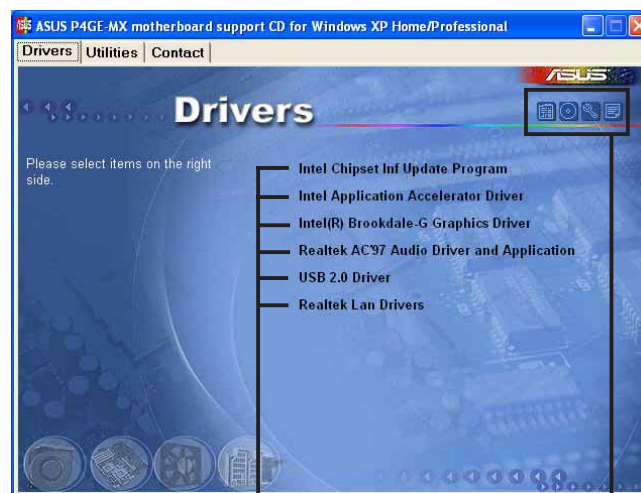

Click an item to install

Click an icon to display more information



If **Autorun** is NOT enabled in your computer, browse the contents of the support CD to locate the file **ASSETUP.EXE** from the **BIN** folder. Double-click the **ASSETUP.EXE** to run the CD.

3.2.2 Drivers menu

The drivers menu shows the available device drivers if the system detects installed devices. Install the necessary drivers to activate the devices.

Intel Chipset Inf Update Program

Click this item to load the installation wizard and install the Intel® Chipset update driver.

Intel Application Accelerator Driver

Click this item to load the installation wizard and install the Intel® Application Accelerator.

Intel Brookdale-G Graphics Driver

Click this item to load the installation wizard and install the Intel® Brookdale-G graphics driver.

Realtek AC'97 Audio Driver and Application

This item installs the Realtek® AC'97 audio driver and applications.

USB 2.0 Driver

This item installs the USB 2.0 driver.

REALTEK LAN Driver

This item installs the Realtek® LAN driver.



For Windows® XP users, make sure to install Windows® XP Service Pack 1 to support USB 2.0.

3.2.3 Utilities menu

The Utilities menu shows the applications and other software that the motherboard supports.

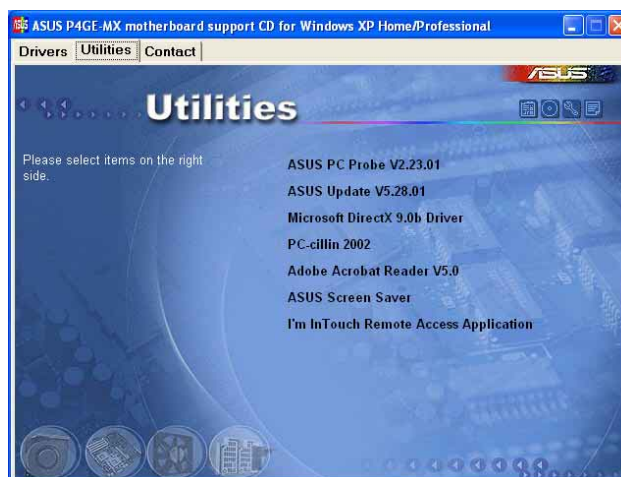

ASUS PC Probe

This smart utility monitors the fan speed, CPU temperature, and system voltages, and alerts you on any detected problems. This utility helps you keep your computer at a healthy operating condition.

Install ASUS Update

This program allows you to download the latest version of the BIOS from the ASUS website. Before using the ASUS Update, make sure that you have an Internet connection so you can connect to the ASUS website. Installing ASUS Update also installs ASUS Mylogo™.

PC-CILLIN

Installs the TrendMicro™ PC-cillin™ anti-virus program. View the PC-cillin™ online help for detailed information.

Acrobat Reader

Installs the Adobe Acrobat® Reader® V5.0. The Acrobat® Reader® software is for viewing files saved in Portable Document Format (PDF).

ASUS Screen Saver

Installs the ASUS screen saver.

I'm In Touch Remote Access Application

Installs the I'm In Touch Remote Access application that allows users to remotely access files or control some hardware from their PC at home or in the office.

3.2.4 ASUS Contact Information

Clicking the ASUS Contact Information tab displays as stated. You may also find this information on the inside front cover of this user guide.



3.3 Audio configurations

The Realtek® ALC655 AC '97 audio CODEC provides 6-channel audio capability to deliver the ultimate audio experience on your PC. The software provides Connector sensing function, S/PDIF out support and interrupt capability.

Follow the installation wizard to install the **Realtek AC97 Audio Driver and Application** from the support CD that came with the motherboard package.

If the Realtek® audio software is correctly installed, you will find the SoundEffect icon on the taskbar.

Launching the AC97 Audio Configuration panel

From the taskbar, double-click on the **SoundEffect** icon to display the **AC97 Audio Configuration** panel.



Realtek SoundEffect icon

Connector sensing feature

The connector sensing feature allows you to check if your audio devices are connected properly. Click the **Connector Sensing** tab to display the details. Click the **Option** button to change sensing options. Click the **Start** button to start connection sensing.

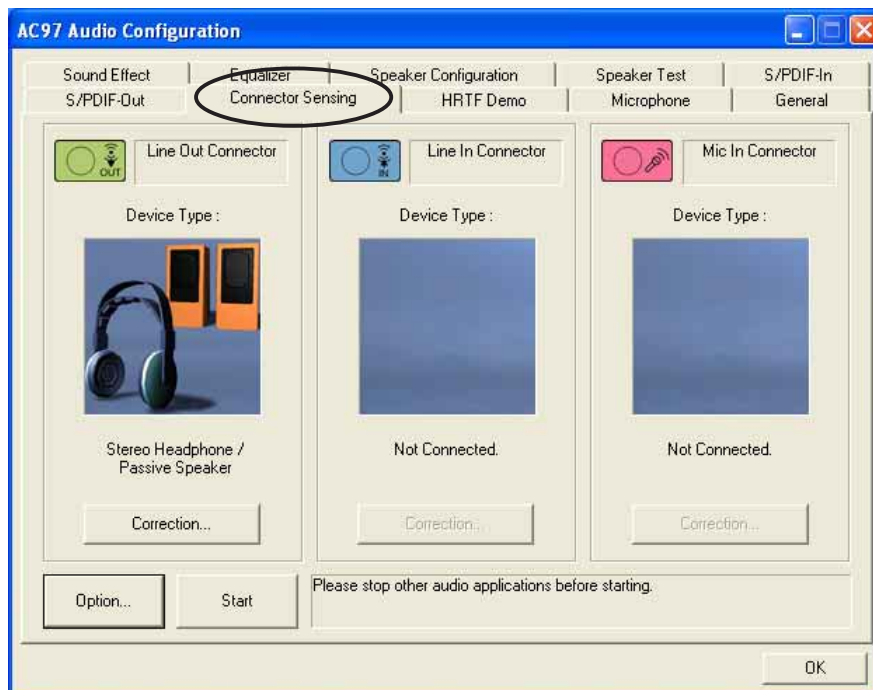

The Realtek® EZ-connection dialog box shows your current audio connections. The text at the bottom of the box explains your audio connection status. An *X mark* denotes an incorrect connection.

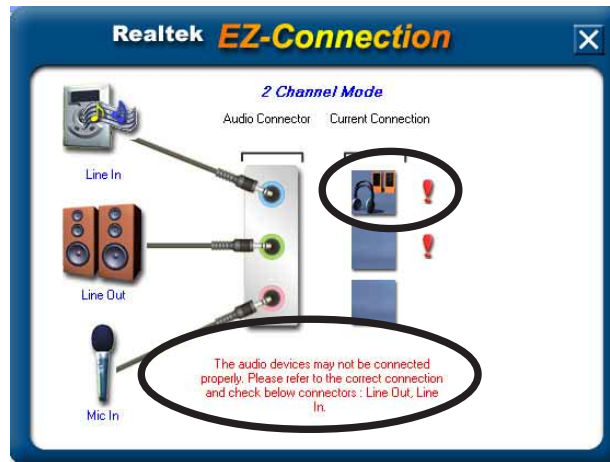

If there are detected problems, make sure that your audio cables are connected to the proper audio jack and repeat connector sensing.

Click the **X** button to exit EZ-connection dialog box.

Click the Exit (**X**) button on the upper-right hand corner of the window to exit audio control panel.