

P5GD2

Deluxe

Motherboard

ASUS[®]

E1674

**First Edition
June 2004**

Copyright © 2004 ASUSTeK COMPUTER INC. All Rights Reserved.

No part of this manual, including the products and software described in it, may be reproduced, transmitted, transcribed, stored in a retrieval system, or translated into any language in any form or by any means, except documentation kept by the purchaser for backup purposes, without the express written permission of ASUSTeK COMPUTER INC. ("ASUS").

Product warranty or service will not be extended if: (1) the product is repaired, modified or altered, unless such repair, modification or alteration is authorized in writing by ASUS; or (2) the serial number of the product is defaced or missing.

ASUS PROVIDES THIS MANUAL "AS IS" WITHOUT WARRANTY OF ANY KIND, EITHER EXPRESS OR IMPLIED, INCLUDING BUT NOT LIMITED TO THE IMPLIED WARRANTIES OR CONDITIONS OF MERCHANTABILITY OR FITNESS FOR A PARTICULAR PURPOSE. IN NO EVENT SHALL ASUS, ITS DIRECTORS, OFFICERS, EMPLOYEES OR AGENTS BE LIABLE FOR ANY INDIRECT, SPECIAL, INCIDENTAL, OR CONSEQUENTIAL DAMAGES (INCLUDING DAMAGES FOR LOSS OF PROFITS, LOSS OF BUSINESS, LOSS OF USE OR DATA, INTERRUPTION OF BUSINESS AND THE LIKE), EVEN IF ASUS HAS BEEN ADVISED OF THE POSSIBILITY OF SUCH DAMAGES ARISING FROM ANY DEFECT OR ERROR IN THIS MANUAL OR PRODUCT.

SPECIFICATIONS AND INFORMATION CONTAINED IN THIS MANUAL ARE FURNISHED FOR INFORMATIONAL USE ONLY, AND ARE SUBJECT TO CHANGE AT ANY TIME WITHOUT NOTICE, AND SHOULD NOT BE CONSTRUED AS A COMMITMENT BY ASUS. ASUS ASSUMES NO RESPONSIBILITY OR LIABILITY FOR ANY ERRORS OR INACCURACIES THAT MAY APPEAR IN THIS MANUAL, INCLUDING THE PRODUCTS AND SOFTWARE DESCRIBED IN IT.

Products and corporate names appearing in this manual may or may not be registered trademarks or copyrights of their respective companies, and are used only for identification or explanation and to the owners' benefit, without intent to infringe.

Contents

Notices	vii
Safety information	viii
About this guide	ix
How this guide is organized	ix
Where to find more information	ix
Conventions used in this guide	x
Typography	x
P5GD2 Deluxe specifications summary	xi

Chapter 1: Product introduction

1.1	Welcome!	1-1
1.2	Package contents	1-1
1.3	Special features	1-2
1.3.1	Product highlights	1-2
1.3.2	ASUS Proactive features	1-5
1.3.3	Innovative ASUS features	1-6

Chapter 2: Hardware information

2.1	Before you proceed	2-1
2.2	Motherboard overview	2-2
2.2.1	Placement direction	2-2
2.2.2	Screw holes	2-2
2.2.3	ASUS Stack Cool	2-3
2.2.4	Motherboard layout	2-4
2.2.5	Layout Contents	2-5
2.3	Central Processing Unit (CPU)	2-7
2.3.1	Installing the CPU	2-7
2.3.2	Installing the CPU heatsink and fan	2-10
2.4	System memory	2-13
2.4.1	Overview	2-13
2.4.2	Memory Configurations	2-13
2.4.3	Installing a DIMM	2-15
2.4.4	Removing a DIMM	2-15
2.5	Expansion slots	2-16
2.5.1	Installing an expansion card	2-16
2.5.2	Configuring an expansion card	2-16

Contents

2.5.3	Interrupt assignments	2-17
2.5.4	PCI slots	2-18
2.5.5	PCI Express x16 slot	2-18
2.5.6	PCI Express x1 slot	2-18
2.6	Jumpers	2-19
2.7	Connectors	2-22
2.7.1	Rear panel connectors	2-22
2.7.2	Internal connectors	2-24

Chapter 3: Powering up

3.1	Starting up for the first time	3-1
3.2	Powering off the computer	3-2
3.2.1	Using the OS shut down function	3-2
3.2.2	Using the dual function power switch	3-2
3.3	ASUS POST Reporter™	3-3
3.3.1	Vocal POST messages	3-3
3.3.2	Winbond Voice Editor	3-5

Chapter 4: BIOS setup

4.1	Managing and updating your BIOS	4-1
4.1.1	Creating a bootable floppy disk	4-1
4.1.2	ASUS EZ Flash utility	4-2
4.1.3	AFUDOS utility	4-3
4.1.4	ASUS CrashFree BIOS 2 utility	4-5
4.1.5	ASUS Update utility	4-7
4.2	BIOS setup program	4-10
4.2.1	BIOS menu screen	4-11
4.2.2	Menu bar	4-11
4.2.3	Navigation keys	4-11
4.2.4	Menu items	4-12
4.2.5	Sub-menu items	4-12
4.2.6	Configuration fields	4-12
4.2.7	Pop-up window	4-12
4.2.8	Scroll bar	4-12
4.2.9	General help	4-12

Contents

4.3	Main menu	4-13
4.3.1	System Time	4-13
4.3.2	System Date	4-13
4.3.3	Legacy Diskette A	4-13
4.3.4	Language	4-13
4.3.5	Primary, Third and Fourth IDE Master/Slave	4-14
4.3.6	IDE Configuration	4-15
4.3.7	System Information	4-17
4.4	Advanced menu	4-18
4.4.1	JumperFree Configuration	4-18
4.4.2	LAN Cable Status	4-21
4.4.3	USB Configuration	4-22
4.4.4	CPU Configuration	4-23
4.4.5	Chipset	4-24
4.4.6	Onboard Devices Configuration	4-26
4.4.7	PCI PnP	4-28
4.4.8	Speech Configuration	4-29
4.5	Power menu	4-30
4.5.1	Suspend Mode	4-30
4.5.2	Repost Video on S3 Resume	4-30
4.5.3	ACPI 2.0 Support	4-30
4.5.4	ACPI APIC Support	4-30
4.5.5	APM Configuration	4-31
4.5.6	Hardware Monitor	4-33
4.6	Boot menu	4-35
4.6.1	Boot Device Priority	4-35
4.6.2	Boot Settings Configuration	4-36
4.6.3	Security	4-37
4.7	Exit menu	4-39

Chapter 5: Software support

5.1	Installing an operating system	5-1
5.2	Support CD information	5-1
5.2.1	Running the support CD	5-1
5.2.2	Drivers menu	5-2

Contents

5.2.3	Utilities menu	5-3
5.2.4	Manuals menu	5-5
5.2.5	ASUS Contact information	5-6
5.2.6	Other information	5-6
5.3	Software information	5-8
5.3.1	ASUS MyLogo2™	5-8
5.3.2	AI NET2	5-10
	Using the Virtual Cable Tester™	5-10
5.3.3	C-Media 3D audio configuration	5-11
5.4	RAID configurations	5-15
5.4.1	Installing hard disks	5-16
5.4.2	Silicon Image RAID configurations	5-17
5.4.3	Intel® RAID configurations	5-27
5.4.4	ITE® 8212F RAID configurations	5-31
5.5	Creating a RAID driver disk	5-37

Notices

Federal Communications Commission Statement

This device complies with Part 15 of the FCC Rules. Operation is subject to the following two conditions:

- This device may not cause harmful interference, and
- This device must accept any interference received including interference that may cause undesired operation.

This equipment has been tested and found to comply with the limits for a Class B digital device, pursuant to Part 15 of the FCC Rules. These limits are designed to provide reasonable protection against harmful interference in a residential installation. This equipment generates, uses and can radiate radio frequency energy and, if not installed and used in accordance with manufacturer's instructions, may cause harmful interference to radio communications. However, there is no guarantee that interference will not occur in a particular installation. If this equipment does cause harmful interference to radio or television reception, which can be determined by turning the equipment off and on, the user is encouraged to try to correct the interference by one or more of the following measures:

- Reorient or relocate the receiving antenna.
- Increase the separation between the equipment and receiver.
- Connect the equipment to an outlet on a circuit different from that to which the receiver is connected.
- Consult the dealer or an experienced radio/TV technician for help.



The use of shielded cables for connection of the monitor to the graphics card is required to assure compliance with FCC regulations. Changes or modifications to this unit not expressly approved by the party responsible for compliance could void the user's authority to operate this equipment.

Canadian Department of Communications Statement

This digital apparatus does not exceed the Class B limits for radio noise emissions from digital apparatus set out in the Radio Interference Regulations of the Canadian Department of Communications.

This class B digital apparatus complies with Canadian ICES-003.

Safety information

Electrical safety

- To prevent electrical shock hazard, disconnect the power cable from the electrical outlet before relocating the system.
- When adding or removing devices to or from the system, ensure that the power cables for the devices are unplugged before the signal cables are connected. If possible, disconnect all power cables from the existing system before you add a device.
- Before connecting or removing signal cables from the motherboard, ensure that all power cables are unplugged.
- Seek professional assistance before using an adapter or extension cord. These devices could interrupt the grounding circuit.
- Make sure that your power supply is set to the correct voltage in your area. If you are not sure about the voltage of the electrical outlet you are using, contact your local power company.
- If the power supply is broken, do not try to fix it by yourself. Contact a qualified service technician or your retailer.

Operation safety

- Before installing the motherboard and adding devices on it, carefully read all the manuals that came with the package.
- Before using the product, make sure all cables are correctly connected and the power cables are not damaged. If you detect any damage, contact your dealer immediately.
- To avoid short circuits, keep paper clips, screws, and staples away from connectors, slots, sockets and circuitry.
- Avoid dust, humidity, and temperature extremes. Do not place the product in any area where it may become wet.
- Place the product on a stable surface.
- If you encounter technical problems with the product, contact a qualified service technician or your retailer.

About this guide

This user guide contains the information you need when installing and configuring the motherboard.

How this guide is organized

This manual contains the following parts:

- **Chapter 1: Product introduction**
This chapter describes the features of the motherboard and the new technology it supports.
- **Chapter 2: Hardware information**
This chapter lists the hardware setup procedures that you have to perform when installing system components. It includes description of the switches, jumpers, and connectors on the motherboard.
- **Chapter 3: Powering up**
This chapter describes the power up sequence, the vocal POST messages, and ways of shutting down the system.
- **Chapter 4: BIOS setup**
This chapter tells how to change system settings through the BIOS Setup menus. Detailed descriptions of the BIOS parameters are also provided.
- **Chapter 5: Software support**
This chapter describes the contents of the support CD that comes with the motherboard package.

Where to find more information

Refer to the following sources for additional information and for product and software updates.

1. ASUS websites

The ASUS website provides updated information on ASUS hardware and software products. Refer to the ASUS contact information.

2. Optional documentation

Your product package may include optional documentation, such as warranty flyers, that may have been added by your dealer. These documents are not part of the standard package.

Conventions used in this guide

To make sure that you perform certain tasks properly, take note of the following symbols used throughout this manual.



DANGER/WARNING: Information to prevent injury to yourself when trying to complete a task.



CAUTION: Information to prevent damage to the components when trying to complete a task.



IMPORTANT: Instructions that you **MUST** follow to complete a task.



NOTE: Tips and additional information to help you complete a task.

Typography

Bold text

Indicates a menu or an item to select

Italics

Used to emphasize a word or a phrase

<Key>

Keys enclosed in the less-than and greater-than sign means that you must press the enclosed key

Example: <Enter> means that you must press the Enter or Return key

<Key1+Key2+Key3>

If you must press two or more keys simultaneously, the key names are linked with a plus sign (+)

Example: <Ctrl+Alt+D>

Command

Means that you must type the command exactly as shown, then supply the required item or value enclosed in brackets

Example: At the DOS prompt, type the command line:

```
afudos /i[filename]
```

```
afudos /iP5GD2.ROM
```

P5GD2 Deluxe specifications summary

CPU	LGA775 socket for Intel® Pentium® 4/Celeron processor Compatible with the Intel® PCG 04A and 04B processors Supports Intel® Hyper-Threading Technology
Chipset	Northbridge: Intel® 915P Memory Controller Hub (MCH) Southbridge: Intel® ICH6R
Front Side Bus	800/533 MHz
Memory	Dual-channel memory architecture 4 x 240-pin DIMM sockets support unbuffered non-ECC 533/400 MHz DDR2 memory modules
Expansion slots	1 x PCI Express x16 slot for discrete graphics card 3 x PCI Express x1 slots 3 x PCI slots
Storage	Intel® ICH6R Southbridge supports: <ul style="list-style-type: none"> - 1 x Ultra DMA 100/66/33 - 4 x Serial ATA with RAID 0, RAID 1 configuration and the Intel® Matrix Storage Technology Silicon Image 3114R RAID controller supports: <ul style="list-style-type: none"> - 4 x Serial ATA - RAID 0, RAID 1, RAID 10, JBOD configuration - RAID 5 (Software patch available, no WHQL) ITE 8212F IDE RAID controller supports: <ul style="list-style-type: none"> - 2 x Ultra DMA 133/100/66 - RAID 0, RAID 1, RAID 0+1, JBOD configuration
High Definition Audio	C-Media CMI9880 High Definition Audio solution with 7.1-channel CODEC 1 x Coaxial S/PDIF out port 1 x Optical S/PDIF out port Supports Dolby® Digital Live™ Technology
Wireless LAN (optional)	WiFi-g™ wireless solution provides: <ul style="list-style-type: none"> - support for IEEE 802.11g/b standard - up to 54Mbps wireless data transmission - Software Access Point (Soft AP) for Windows® XP and 2003 Server)
Innovative Thermal solution	ASUS Stack Cool patented fanless cooling system

(continued on the next page)

P5GD2 Deluxe specifications summary

LAN	<p>Marvell® 88E8053 PCI Express™ Gigabit LAN controller</p> <p>Supports Marvell® Virtual Cable Tester technology</p> <p>Supports POST Network-diagnostic program</p>
Overclocking	<p>ASUS AI NOS (Non-delay Overclocking System) feature</p> <p>ASUS AI Overclocking (Intelligent CPU frequency tuner)</p> <p>ASUS C.P.R. (CPU Parameter Recall)</p> <p>CPU, Memory, and PCI Express voltage adjustable</p> <p>Stepless Frequency Selection(SFS) from 100 MHz up to 400 MHz at 1 MHz increment</p> <p>Adjustable FSB/DDR2 ratio with fixed PCI/PCI-E frequencies</p>
IEEE 1394	<p>T1 1394 controller supports:</p> <ul style="list-style-type: none"> - 2 x IEEE 1394 connectors
USB	<p>Supports up to 8 USB 2.0 ports</p>
Special features	<p>ASUS Post Reporter™</p> <p>ASUS Q-Fan2</p> <p>ASUS CrashFree BIOS 2</p> <p>ASUS Multi-language BIOS</p> <p>ASUS MyLogo2</p>
BIOS features	<p>8 MB Flash ROM, AMI BIOS, PnP, DMI2.0, SM BIOS 2.3, WfM2.0</p>
Rear panel	<ul style="list-style-type: none"> 1 x Parallel port 1 x LAN (RJ-45) port 1 x Rear speaker out port 1 x Side speaker out port 1 x Line In port 1 x Line Out port 1 x WiFi-g™ antenna port (Wireless Edition only) 1 x Wireless LAN LED (Wireless Edition only) 1 x Microphone port 1 x Center/Subwoofer port 4 x USB 2.0 ports 1 x Optical S/PDIF out port 1 x Coaxial S/PDIF out port 1 x PS/2 keyboard port 1 x PS/2 mouse port

(continued on the next page)

P5GD2 Deluxe specifications summary

Internal connectors	1 x Floppy disk drive connector 1 x Primary IDE connector 2 x IDE RAID connectors 8 x Serial ATA connectors 1 x CPU fan connector 1 x Power fan connector 2 x Chassis fan connector 1 x Serial port connector (COM port) 1 x 24-pin ATX power connector 1 x 4-pin ATX 12 V power connector 2 x USB 2.0 connectors for 4 additional USB 2.0 ports 1 x Optical drive audio connector 1 x GAME/MIDI connector 1 x Chassis intrusion connector 1 x Front panel audio connector System panel connector
Power Requirement	ATX power supply (with 24-pin and 4-pin 12 V plugs) ATX 12 V 2.0 compliant
Form Factor	ATX form factor: 12 in x 9.6 in (30.5 cm x 24.4 cm)
Support CD contents	Device drivers ASUS PC Probe ASUS Live Update Utility Anti-virus software (OEM version)

**Specifications are subject to change without notice.*

This chapter describes the motherboard features and the new technologies it supports.

Product introduction



Chapter summary

1.1	Welcome!	1-1
1.2	Package contents	1-1
1.3	Special features	1-2

1.1 Welcome!

Thank you for buying an ASUS® P5GD2 Deluxe motherboard!

The motherboard delivers a host of new features and latest technologies, making it another standout in the long line of ASUS quality motherboards!

Before you start installing the motherboard, and hardware devices on it, check the items in your package with the list below.

1.2 Package contents

Check your motherboard package for the following items.

Motherboard	ASUS P5GD2 Deluxe motherboard
I/O modules	Serial port module (COM port) IEEE 1394 (1 port) module USB 2.0 (2 ports) and GAME (1 port) module
Cables	6 x Serial ATA signal cables 3 x Serial ATA power cables (dual plugs) 2 x Ultra DMA/133 cables 40-conductor IDE cable Floppy disk drive cable
Accessories	Dipolar wireless LAN antenna (Wireless Edition only) I/O shield
Application CDs	ASUS motherboard support CD InterVideo® WinDVD Suite® (retail box only)
Documentation	User guide



If any of the above items is damaged or missing, contact your retailer.

1.3 Special features

1.3.1 Product highlights

Latest processor technology

The motherboard comes with a 775-pin surface mount Land Grid Array (LGA) socket designed for the Intel® Pentium® 4 processor in the 775-land package. The motherboard supports the Intel® Pentium® 4 processor. The motherboard also supports the Intel® Hyper-Threading Technology and is fully compatible with Intel® 04B and 04A processors. See page 2-7 for details.

Intel® 915P

The Intel® 915P chipset provides the interface for a processor in the 775-land package with 533/800MHz front side bus (FSB), dual channel DDR/DDR2 at speeds of up to 533MHz, and PCI Express x16-lane port for graphics card. The Intel® 915P MCH platform is compliant to the Direct Media Interface (DMI) and supports the sixth generation I/O Controller Hub (ICH6).

DDR2 memory support

The motherboard supports DDR2 memory which features data transfer rates of 533/400 MHz to meet the higher bandwidth requirements of the latest 3D graphics, multimedia, and Internet applications. The dual-channel DDR2 architecture doubles the bandwidth of your system memory to boost system performance, eliminating bottlenecks with peak bandwidths of up to 8.5 GB/s. The motherboard also allows you to overclock DDR2-533 DIMMs up to 600 MHz while maintaining the CPU Front Side Bus at 800 MHz*. See pages 2-13 and 4-19 for details.

* Visit the ASUS website for the list of qualified DDR2-533 DIMMS that support 600 MHz frequency.

Serial ATA technology

The motherboard supports the Serial ATA technology through the Serial ATA interfaces and the Intel® ICH6R. The SATA specification allows for thinner, more flexible cables with lower pin count, reduced voltage requirement, and up to 150 MB/s data transfer rate.

Triple RAID solution

Onboard RAID controllers provide the motherboard with multi-RAID functionality that allows you to select the best RAID solution using IDE or Serial ATA devices.

The Intel® ICH6R allows RAID 0 and RAID 1 configuration for four SATA connectors and supports the Intel® Matrix Storage Technology. See pages 2-26 and 5-27 for details.

The Sil3114R controller supports four additional SATA connectors and allows RAID 0, RAID 1, RAID 10, JBOD, and a software patch to support RAID 5. See pages 2-27 and 5-17 for details.

If you are using IDE hard disk drives, the ITE 8212 controller provides RAID 0, RAID 1, RAID 0+1, and JBOD functionality for two IDE channels that supports for up to four IDE hard disk drives. See pages 2-25 and 5-31 for details.

PCI Express™ interface

The motherboard fully supports PCI Express, the latest I/O interconnect technology that speeds up the PCI bus. PCI Express features point-to-point serial interconnections between devices and allows higher clockspeeds by carrying data in packets. This high speed interface is software compatible with existing PCI specifications. See page 2-18 for details.

8-channel high definition audio

Onboard is the C-Media CMI9880 7.1-channel audio CODEC. This CODEC is fully-compliant with Intel® High Definition Audio standard (192 KHz, 24-bit audio). With the CODEC, 8-channel audio ports, and S/PDIF interfaces, you can connect your computer to home theater decoders to produce crystal-clear digital audio.

The CMI9880 CODEC comes with a software application that features jack detection to monitor the plugging status of each jack, impedance sensing to determine audio device classes, and pre-defined equalization for various audio devices. See page 2-22 and 2-23 for details.

Dolby® Digital Live™

The CMI9880 audio CODEC comes with an AC-3 encoder capable of transforming your computer's digital audio contents into real-time Dolby® Digital stream. This digital stream passes through the S/PDIF out interfaces to an AC-3 or DTS decoder for 7.1-channel playback.

S/PDIF digital sound ready

The motherboard supports the S/PDIF In/Out function through the S/PDIF interfaces on the rear panel and at midboard. The S/PDIF technology turns your computer into a high-end entertainment system with digital connectivity to powerful audio and speaker systems. See page 2-23 for details.

USB 2.0 technology

The motherboard implements the Universal Serial Bus (USB) 2.0 specification, dramatically increasing the connection speed from the 12 Mbps bandwidth on USB 1.1 to a fast 480 Mbps on USB 2.0. USB 2.0 is backward compatible with USB 1.1. See page 2-23 and 2-29 for details.

Temperature, fan, and voltage monitoring

The CPU temperature is monitored by the ASIC (integrated in the Winbond Super I/O) to prevent overheating and damage. The system fan rotations per minute (RPM) is monitored for timely failure detection. The ASIC monitors the voltage levels to ensure stable supply of current for critical components.

1.3.2 ASUS Proactive features

ASUS Stack Cool

ASUS Stack Cool is an ideal thermal solution that reduces the heat dissipated by large capacitors and motherboard components. By placing a specially designed PCB under the motherboard CPU socket, Stack Cool effectively lowers the system temperature by 10° Celsius. Cooler system temperature means more stable system performance, longer component life, and more silent operation.

ASUS WiFi-g™ (Wireless Edition only)

ASUS WiFi-g™ is an IEEE 802.11g-compliant wireless LAN adapter that allows data transmission of up to 54 Mbps using the 2.4 GHz frequency band. ASUS provides full software application support and a user-friendly wizard to help you set up your wireless local area network effortlessly. The ASUS WiFi-g™ is backward compatible with IEEE 802.11b devices.

AI NOS™ (Non-Delay Overclocking System)

ASUS Non-delay Overclocking System™ (NOS) is a technology that auto-detects the CPU loading and dynamically overclocks the CPU speed only when needed.

AI Net2

AI Net2 is a BIOS-based diagnostic tool that detects and reports Ethernet cable faults and shorts. With this utility, you can easily monitor the condition of the Ethernet cable(s) connected to the LAN (RJ-45) port(s). During the bootup process, AI Net2 immediately diagnoses the LAN cable(s) and reports shorts and faults up to 100 meters at 1 meter accuracy.

1.3.3 Innovative ASUS features

CrashFree BIOS 2

This feature allows you to restore the original BIOS data from the support CD in case when the BIOS codes and data are corrupted. This protection eliminates the need to buy a replacement ROM chip. See details on page 4-5.

ASUS Q-Fan 2 technology

The ASUS Q-Fan 2 technology smartly adjusts the CPU and chassis fan speeds according to the system loading to ensure quiet, cool, and efficient operation. See page 4-33 for details.

ASUS POST Reporter™

The motherboard offers a new exciting feature called the ASUS POST Reporter™ to provide friendly voice messages and alerts during the Power-On Self-Tests (POST) informing you of the system boot status and causes of boot errors, if any. The bundled Winbond Voice Editor software lets you to customize the voice messages in different languages. See page 3-3 for details.

ASUS Multi-language BIOS

The multi-language BIOS allows you to select the language of your choice from the available options. The localized BIOS menus allow you to configure easier and faster. See page 4-13 for details.

ASUS MyLogo2™

This new feature present in the motherboard allows you to personalize and add style to your system with customizable boot logos.

This chapter lists the hardware setup procedures that you have to perform when installing system components. It includes description of the jumpers and connectors on the motherboard.

Hardware information



Chapter summary

2.1	Before you proceed	2-1
2.2	Motherboard overview	2-2
2.3	Central Processing Unit (CPU)	2-7
2.4	System memory	2-13
2.5	Expansion slots	2-16
2.6	Jumpers	2-19
2.7	Connectors	2-22

2.1 Before you proceed

Take note of the following precautions before you install motherboard components or change any motherboard settings.



- Unplug the power cord from the wall socket before touching any component.
- Use a grounded wrist strap or touch a safely grounded object or to a metal object, such as the power supply case, before handling components to avoid damaging them due to static electricity
- Hold components by the edges to avoid touching the ICs on them.
- Whenever you uninstall any component, place it on a grounded antistatic pad or in the bag that came with the component.
- **Before you install or remove any component, ensure that the ATX power supply is switched off or the power cord is detached from the power supply.** Failure to do so may cause severe damage to the motherboard, peripherals, and/or components.

Onboard LED

The motherboard comes with a standby power LED that lights up to indicate that the system is ON, in sleep mode, or in soft-off mode. This is a reminder that you should shut down the system and unplug the power cable before removing or plugging in any motherboard component. The illustration below shows the location of the onboard LED.

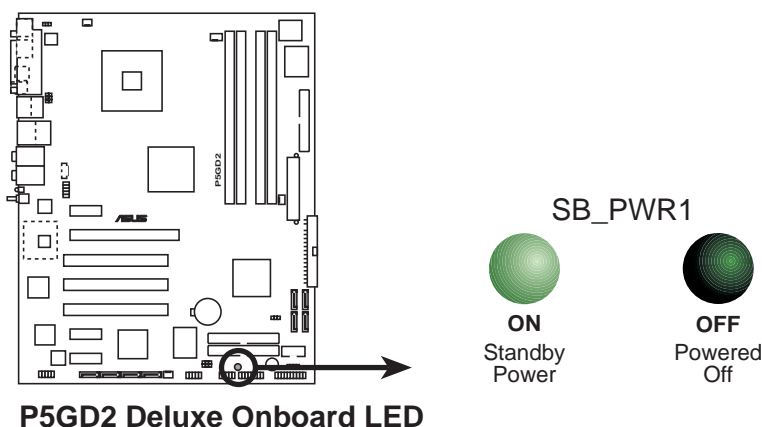

2.2 Motherboard overview

Before you install the motherboard, study the configuration of your chassis to ensure that the motherboard fits into it.



Make sure to unplug the power cord before installing or removing the motherboard. Failure to do so can cause you physical injury and damage motherboard components.

2.2.1 Placement direction

When installing the motherboard, make sure that you place it into the chassis in the correct orientation. The edge with external ports goes to the rear part of the chassis as indicated in the image below.

2.2.2 Screw holes

Place nine (9) screws into the holes indicated by circles to secure the motherboard to the chassis.



Do not overtighten the screws! Doing so can damage the motherboard.

Place this side towards
the rear of the chassis

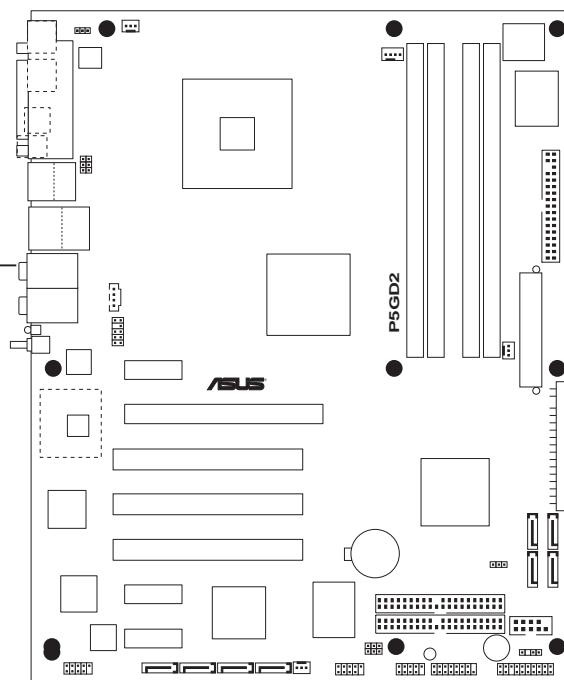

2.2.3 ASUS Stack Cool

The motherboard comes with ASUS Stack Cool, an innovative thermal solution that provides supplementary cooling to the motherboard. Stack Cool is a mini-PCB installed under the motherboard CPU socket to conduct heat away from motherboard components. Stack Cool effectively lowers the motherboard temperature by as much as 10°C.

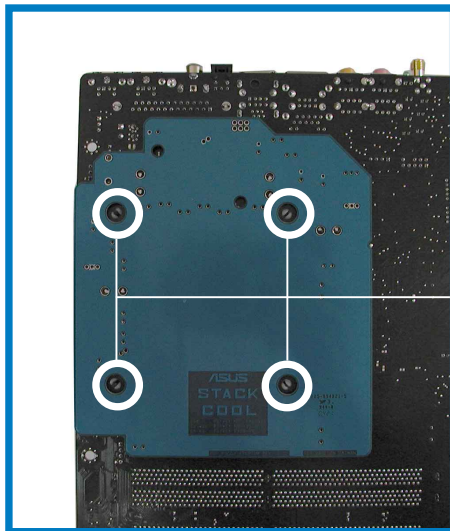

**Motherboard holes
(for the CPU fan and
heatsink assembly pins)**

2.2.4 Motherboard layout

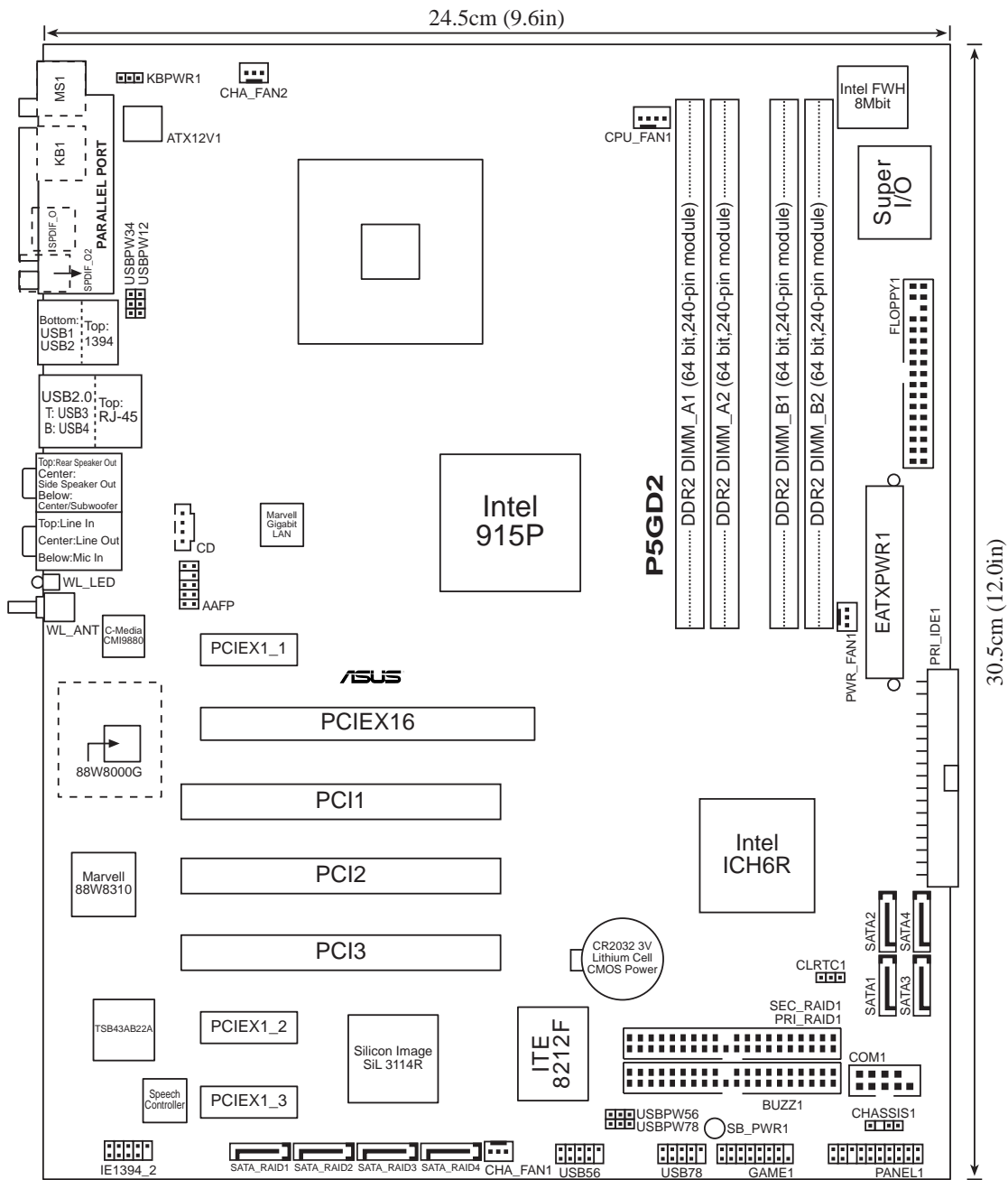

2.2.5 Layout Contents

Slots	Page
1. DDR2 DIMM slots	2-13
2. PCI slots	2-18
3. PCI Express slot	2-18

Jumpers	Page
1. Clear RTC RAM (3-pin CLRTC1)	2-19
2. USB Device wake-up (3-pin USBPW12, USBPW34, USBPW56, USBPW78)	2-20
3. Keyboard power (3-pin KBPWR1)	2-21

Rear panel connectors	Page
1. Parallel port	2-22
2. IEEE 1394 port	2-22
3. RJ-45 port	2-22
4. Rear Speaker Out port	2-22
5. Side Speaker Out port	2-22
6. Line In port	2-22
7. Line Out port	2-22
8. WiFi-g antenna port	2-23
9. Wireless LAN LED	2-23
10. Microphone port	2-23
11. Center/Subwoofer port	2-23
12. USB 2.0 ports 3 and 4	2-23
13. USB 2.0 ports 1 and 2	2-23
14. S/PDIF optical out port	2-23
15. S/PDIF coaxial out port	2-23
16. PS/2 keyboard port	2-23
17. PS/2 mouse port	2-23

Internal connectors	Page
1. Floppy disk drive connector (34-1 pin FLOPPY)	2-24
2. Primary IDE connector (40-1 pin PRI_IDE1)	2-24
3. Primary RAID ATA connector (40-1 pin PRI_RAID1)	2-25
4. Secondary RAID ATA connector (40-1 pin SEC_RAID1)	2-25
5. Serial ATA connectors (7-pin SATA1, SATA2, SATA3, SATA4)	2-26
6. Serial ATA RAID connectors (7-pin SATA_RAID1, SATA_RAID2, SATA_RAID3, SATA_RAID4)	2-27
7. CPU fan connector (4-pin CPU_FAN1)	2-28
8. Power fan connector (3-pin PWR_FAN1)	2-28
9. Chassis fan connector (3-pin CHA_FAN1)	2-28
10. Chassis fan 2 connector (3-pin CHA_FAN2)	2-28
11. Serial port connector (10-1 pin COM1)	2-29
12. USB headers (10-1 USB56, USB78)	2-29
13. ATX power connector (24-pin EATXPWR1)	2-30
14. ATX 12V power connector (4-pin ATX12V1)	2-30
15. Optical audio connector (4-pin CD)	2-31
16. GAME/MIDI connector (16-1 pin GAME1)	2-31
17. Chassis intrusion connector (4-1 pin CHASSIS1)	2-32
18. Front panel audio connector (10-1 pin AAFP)	2-32
19. System panel connectors (20-1 pin PANEL)	2-33
- System Power LED (Green 3-pin PLED)	
- Hard Disk activity (Red 2-pin IDE_LED)	
- System warning speaker (Orange 4-pin SPEAKER)	
- Power/Soft-off button (Yellow 2-pin PWR)	
- Reset switch (Blue 2-pin RESET)	

2.3 Central Processing Unit (CPU)

The motherboard comes with a surface mount LGA775 socket designed for the Intel® Pentium® 4 processor in the 775-land package.



- Upon purchase of the motherboard, make sure that the LGA775 socket has its PnP cap on and the socket contacts are not bent. If the cap is damaged or missing, or if the socket contacts are bent, contact your retailer immediately.
- Keep the PnP cap after installing the motherboard. ASUS will process Return Merchandise Authorization (RMA) requests only if the motherboard comes with the PnP cap on the LGA775 socket.

2.3.1 Installing the CPU

To install a CPU:

1. Locate the CPU socket on the motherboard.

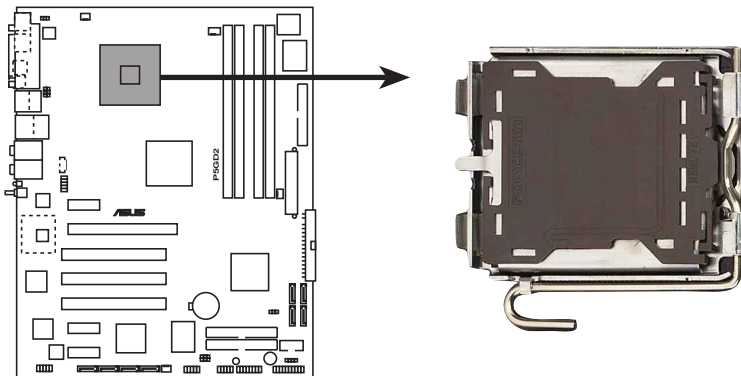

P5GD2 Deluxe Socket 775



Before installing the CPU, make sure that the socket box is facing towards you and the load lever is on your left.

2. Press the load lever with your thumb (A) and move it to the left (B) until it is released from the retention tab.

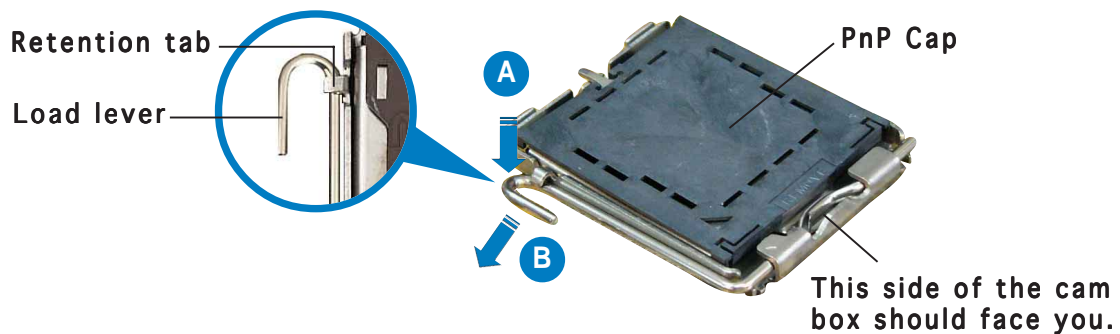



To prevent damage to the socket pins, do not remove the PnP cap unless you are installing a CPU.

3. Lift the load lever in the direction of the arrow to a 135° angle.

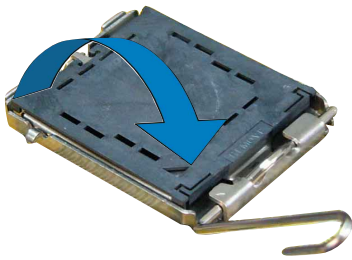

4. Lift the load plate with your thumb and forefinger to a 100° angle (A), then push the PnP cap from the load plate window to remove (B).

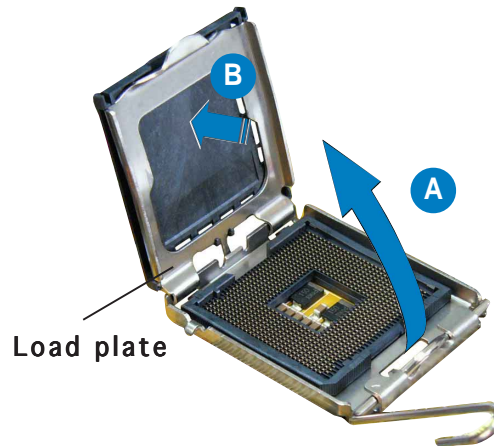

5. Position the CPU over the socket, making sure that the gold triangle is on the bottom-left corner of the socket. The socket alignment key should fit into the CPU notch.

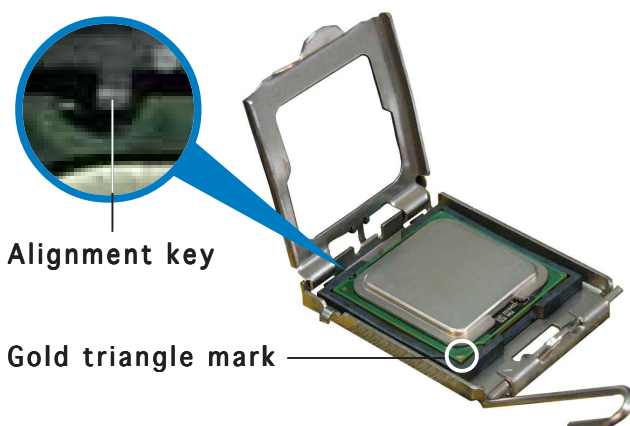

6. Close the load plate (A), then push the load lever (B) until it snaps into the retention tab.

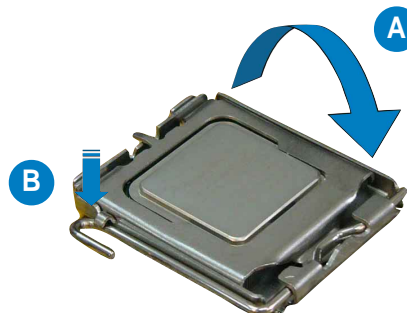

The CPU fits in only one correct orientation. DO NOT force the CPU into the socket to prevent bending the connectors on the socket and damaging the CPU!

Notes on Intel® Hyper-Threading Technology



- This motherboard supports Intel® Pentium® 4 CPUs in the 775-land package with Hyper-Threading Technology.
 - Hyper-Threading Technology is supported under Windows® XP/2003 Server and Linux 2.4.x (kernel) and later versions only. Under Linux, use the Hyper-Threading compiler to compile the code. If you are using any other operating systems, disable the Hyper-Threading Technology item in the BIOS to ensure system stability and performance.
 - Installing the Windows® XP Service Pack 1 or later version is recommended.
 - Make sure to enable the Hyper-Threading Technology item in BIOS before installing a supported operating system.
 - For more information on Hyper-Threading Technology, visit www.intel.com/info/hyperthreading.
-

To use the Hyper-Threading Technology on this motherboard:

1. Install an Intel® Pentium® 4 CPU that supports Hyper-Threading Technology.
2. Power up the system and enter the BIOS Setup (see Chapter 4: BIOS setup). Under the Advanced Menu, make sure that the item Hyper-Threading Technology is set to Enabled. The item appears only if you installed a CPU that supports Hyper-Threading Technology.
3. Reboot the computer.

2.3.2 Installing the CPU heatsink and fan

The Intel® Pentium® 4 LGA775 processor requires a specially designed heatsink and fan assembly to ensure optimum thermal condition and performance.



- Install the motherboard to the chassis before you install the CPU fan and heatsink assembly
- When you buy a boxed Intel® Pentium® 4 processor, the package includes the CPU fan and heatsink assembly. If you buy a CPU separately, make sure that you use only Intel®-certified multi-directional heatsink and fan.
- Your boxed Intel® Pentium® 4 LGA775 processor package should come with installation instructions for the CPU, heatsink, and the retention mechanism. If the instructions in this section do not match the CPU documentation, follow the latter.
- Your Intel® Pentium® 4 LGA775 heatsink and fan assembly comes in a push-pin design and requires no tool to install.

Follow these steps to install the CPU heatsink and fan.

1. Place the heatsink on top of the installed CPU, making sure that the four pins match the holes on the motherboard.

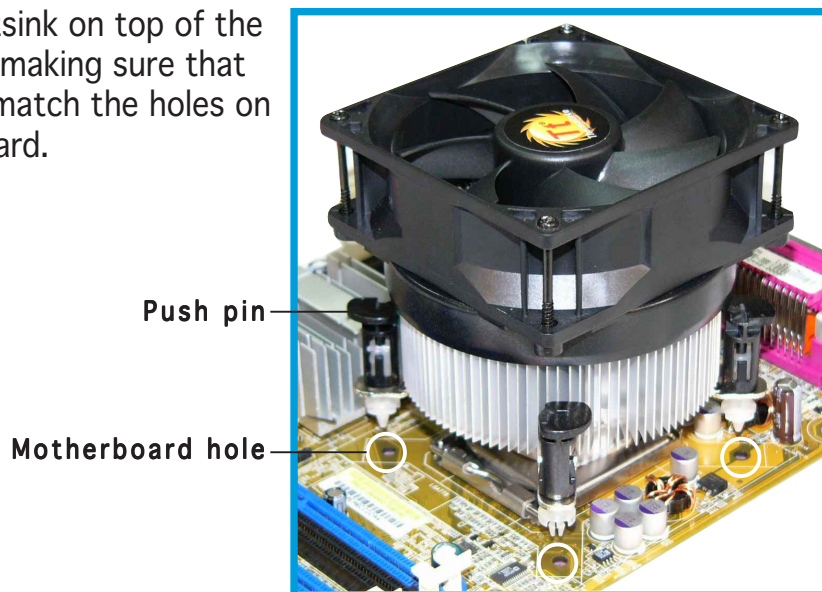

2. Push each of the pins downward to secure the heatsink and fan assembly in place.



3. Rotate the push-pins clockwise to lock.



4. When the fan and heatsink assembly is in place, connect the CPU fan cable to the connector on the motherboard labeled CPU_FAN1.

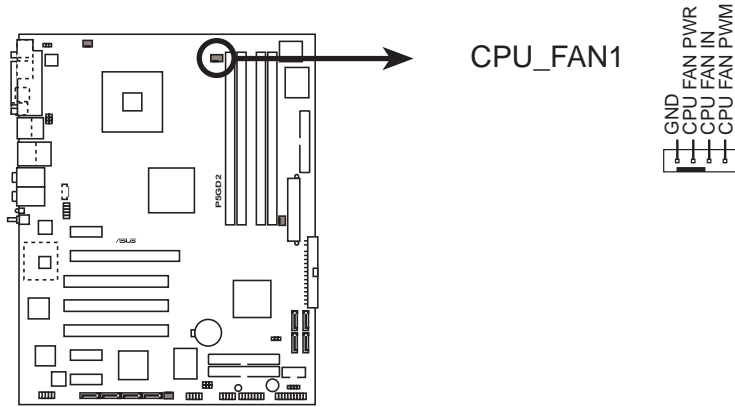

P5GD2 Deluxe CPU fan connector



Do not forget to connect the CPU fan connector! Hardware monitoring errors can occur if you fail to plug this connector.

2.4 System memory

2.4.1 Overview

The motherboard comes with four 240-pin Double Data Rate 2 (DDR2) Dual Inline Memory Modules (DIMM) sockets.

A DDR2 module has the same physical dimensions as a DDR DIMM but has a 240-pin footprint compared to the 184-pin DDR DIMM. DDR2 DIMMs are notched differently to prevent installation on a DDR DIMM socket.

The following figure illustrates the location of the sockets:

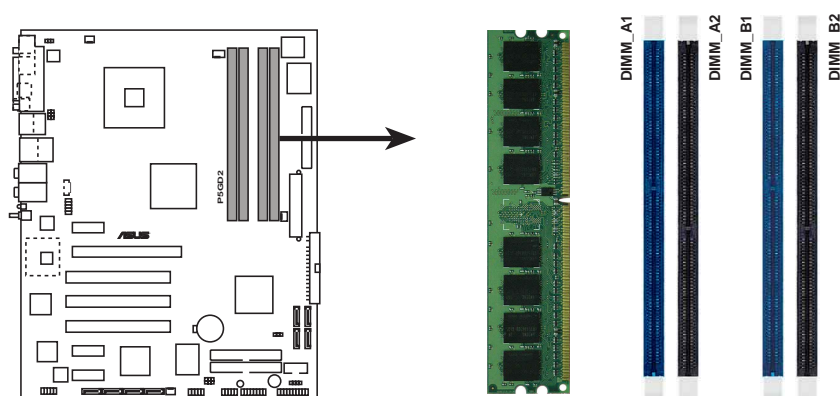

P5GD2 Deluxe 184-Pin DDR DIMM sockets

2.4.2 Memory Configurations

You may install 256 MB, 512 MB and 1 GB unbuffered non-ECC DDR2 DIMMs into the DIMM sockets using the memory configurations in this section.



- In dual-channel configurations, we recommend to install **identical** DDR2 DIMM pairs for each channel for optimum performance.
- Always install DIMMs with the same CAS latency. For optimum compatibility, it is recommended that you obtain memory modules from the same vendor. See the DDR2 533 Qualified Vendors List (QVL) on page 2-14 for details.
- Due to chipset resource allocation, the system may detect less than 4 GB of system memory when you installed four 1 GB DDR2 memory modules.
- Due to chipset limitation, DIMM modules with 128 Mb memory chips or double-sided x16 memory chips are not supported in this motherboard.

DDR2 533 Qualified Vendors List

Size	Vendor	Model	Side(s)	Component	DIMM support		
					A *	B *	C *
512MB	SAMSUNG	M378T6553BG0-CD5	SS	K4T51083QB-GCD5	•	•	•
1024MB	SAMSUNG	M378T2953BG0-CD5	DS	K4T51083QB-GCD5	•	•	•
256MB	SAMSUNG	M378T3253FG0-CD5	SS	K4T56083QF-GCD5	•	•	•
512MB	SAMSUNG	M378T6453FG0-CD5	DS	K4T56083QF-GCD5	•	•	•
512MB	Infineon	HYS64T64000GU-3.7-A	SS	HYB18T512800AC37	•	•	
512MB	CORSAIR	CM2X512-4300	DS	Heat-Sink Package	•	•	•
512MB	CORSAIR	CM2X512-4200	DS	Heat-Sink Package	•	•	•
128MB	MICRON	MT4HTF1664AG-53EB1	SS	3WBIIZ9BXX	•	•	
256MB	MICRON	MT8HTF3264AG-53EB3	SS	3TBIIZ9BQT	•		
512MB	MICRON	MT16HTF6464AG-53EB1	DS	3TBIIZ9BQT	•	•	
512MB	MICRON	MT16HTF6464AG-53EB2	DS	4FBIIID9BQM	•	•	•
256MB	MICRON	N/A	SS	4DBIIZ9BQT	•	•	
1024MB	MICRON	MT16HTF12864AY-53EA1	DS	4JAIIID9CRZ	•	•	•
512MB	Hynix	HYMP564U648-C4	SS	HY5PS12821F-C4	•	•	•
1024MB	Hynix	HYMP512U648-C4	DS	HY5PS12821F-C4	•	•	•
1024MB	Hynix	HYMP512U648-C4	DS	HY5PS12821FP-C4	•	•	•
512MB	KINGMAX	KLBC28K-38MP4	DS	4IBIIID9BQM	•	•	
512MB	A-DATA	N/A	SS	K4T51083QB-GCD5	•	•	•
512MB	TwinMOS	8D-22JB5-K2T	SS	K4T51083QB-GCD5	•	•	•
512MB	Apacer	78.91066.460	SS	K4T51083QB-GCD5	•	•	•
1024MB	Apacer	78.01066.460	DS	K4T51083QB-GCD5	•	•	
512MB	Apacer	78.91066.110	SS	HYB18T512800AC37	•	•	•
1024MB	Apacer	78.01066.110	DS	HYB18T512800AC37	•	•	
256MB	BRAIN POWER	BS212-1-256M-MIC-533	DS	4CBIIZ9BQT	•		
512MB	BRAIN POWER	BS213-1-512M-MIC-533	DS	4CBIIZ9BQT	•	•	
512MB	ELPIDA	EBE51UD8ABFA-5C	DS	E5108AB-5C-E	•	•	
512MB	ELPIDA	EBE51UD8ABFA-5C-E	DS	E5108AB-5C-E	•	•	•
1024MB	ELPIDA	EBE11UD8ABFA-5C-E	DS	E5108AB-5C-E	•	•	•
512MB	Pmi	MAB4512MIC	DS	K4T51083QB-GCD5	•		

- A** - supports one module inserted into either slot, in a Single-channel memory configuration.
- B** - supports on pair of modules inserted into either the yellow slots or the black slots as one pair of Dual-channel memory configuration.
- C** - support for 4 modules inserted into the yellow and black slots as two pairs of Dual-channel memory configuration.
- SS** - Single-sided
- DS** - Double-sided

2.4.3 Installing a DIMM



Unplug the power supply before adding or removing DIMMs or other system components. Failure to do so can cause severe damage to both the motherboard and the components.

To install a DIMM:

1. Unlock a DIMM socket by pressing the retaining clips outward.
2. Align a DIMM on the socket such that the notch on the DIMM matches the break on the socket.
3. Firmly insert the DIMM into the socket until the retaining clips snap back in place and the DIMM is properly seated.

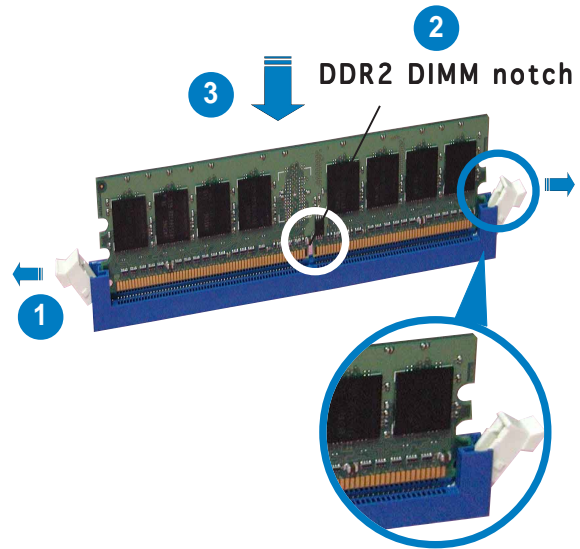

Unlocked retaining clip



- A DDR2 DIMM is keyed with a notch so that it fits in only one direction. Do not force a DIMM into a socket to avoid damaging the DIMM.
- The DDR2 DIMM sockets do not support DDR DIMMs. DO not install DDR DIMMs to the DDR2 DIMM sockets.

2.4.4 Removing a DIMM

Follow these steps to remove a DIMM.

1. Simultaneously press the retaining clips outward to unlock the DIMM.



Support the DIMM lightly with your fingers when pressing the retaining clips. The DIMM might get damaged when it flips out with extra force.

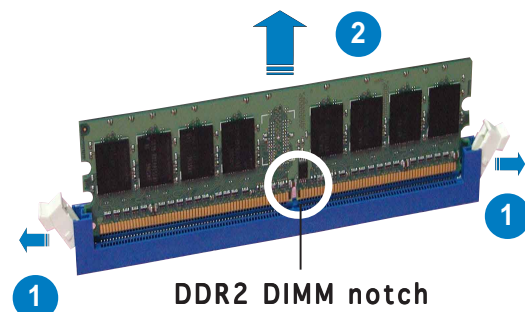

2. Remove the DIMM from the socket.

2.5 Expansion slots

In the future, you may need to install expansion cards. The following sub-sections describe the slots and the expansion cards that they support.



Make sure to unplug the power cord before adding or removing expansion cards. Failure to do so may cause you physical injury and damage motherboard components.

2.5.1 Installing an expansion card

To install an expansion card:

1. Before installing the expansion card, read the documentation that came with it and make the necessary hardware settings for the card.
2. Remove the system unit cover (if your motherboard is already installed in a chassis).
3. Remove the bracket opposite the slot that you intend to use. Keep the screw for later use.
4. Align the card connector with the slot and press firmly until the card is completely seated on the slot.
5. Secure the card to the chassis with the screw you removed earlier.
6. Replace the system cover.

2.5.2 Configuring an expansion card

After installing the expansion card, configure the it by adjusting the software settings.

1. Turn on the system and change the necessary BIOS settings, if any. See Chapter 4 for information on BIOS setup.
2. Assign an IRQ to the card. Refer to the tables on the next page.
3. Install the software drivers for the expansion card.

2.5.3 Interrupt assignments

Standard interrupt assignments

IRQ	Priority	Standard Function
0	1	System Timer
1	2	Keyboard Controller
2	•	Re-direct to IRQ#9
3	11	Communications Port (COM2)*
4	12	Communications Port (COM1)*
5	13	IRQ holder for PCI steering*
6	14	Floppy Disk Controller
7	15	Printer Port (LPT1)*
8	3	System CMOS/Real Time Clock
9	4	IRQ holder for PCI steering*
10	5	IRQ holder for PCI steering*
11	6	IRQ holder for PCI steering*
12	7	PS/2 Compatible Mouse Port*
13	8	Numeric Data Processor
14	9	Primary IDE Channel
15	10	Secondary IDE Channel

* These IRQs are usually available for ISA or PCI devices.

IRQ assignments for this motherboard

	A	B	C	D	E	F	G	H
PCI slot 2	—	—	—	—	shared	shared	shared	shared
PCI slot 3	shared	shared	shared	shared	—	—	—	—
PCI E x1 slot 1	—	—	shared	—	—	—	—	—
PCI E x1 slot 2	shared	—	—	—	—	—	—	—
PCI E x1 slot 3	—	—	—	shared	—	—	—	—
PCI E x16 slot	shared	—	—	—	—	—	—	—
Onboard USB controller 1	—	—	—	—	—	—	—	shared
Onboard USB controller 2	—	—	—	shared	—	—	—	—
Onboard USB controller 3	—	—	shared	—	—	—	—	—
Onboard USB controller 4	shared	—	—	—	—	—	—	—
Onboard USB 2.0 controller	—	—	—	—	—	—	—	shared
Onboard LAN1	—	shared	—	—	—	—	—	—
Onboard Azalia audio	shared	—	—	—	—	—	—	—
Onboard PCI SATA RAID (SI)	—	—	—	—	—	—	shared	—
Onboard PCI IDE RAID (ITE)	—	—	—	—	—	—	—	shared
Onboard wireless LAN	—	—	—	—	shared	—	—	—



When using PCI cards on shared slots, ensure that the drivers support “Share IRQ” or that the cards do not need IRQ assignments. Otherwise, conflicts will arise between the two PCI groups, making the system unstable and the card inoperable.

2.5.4 PCI slots

The PCI slots support cards such as a LAN card, SCSI card, USB card, and other cards that comply with PCI specifications. The figure shows a LAN card installed on a PCI slot.

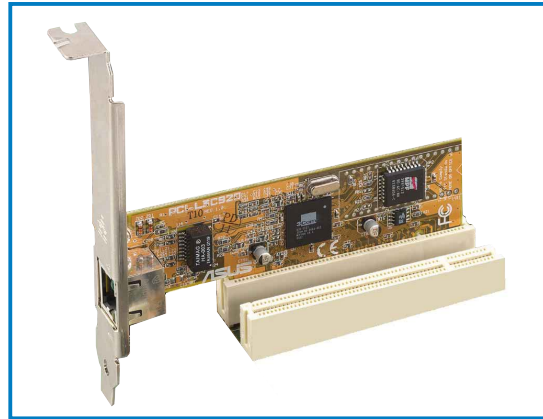

2.5.5 PCI Express x16 slot

This motherboard supports PCI Express x16 graphic cards that comply with the PCI Express specifications. The figure shows a graphics card installed on the PCI Express x16 slot.

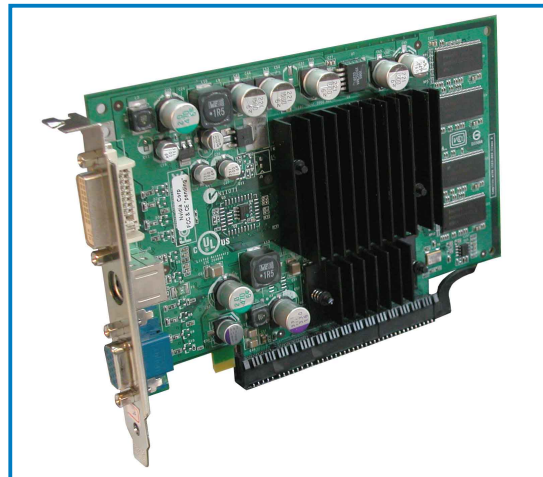

2.5.6 PCI Express x1 slot

This motherboard supports PCI Express x1 network cards, SCSI cards and other cards that comply with the PCI Express specifications. The figure shows a network card installed on the PCI Express x1 slot.

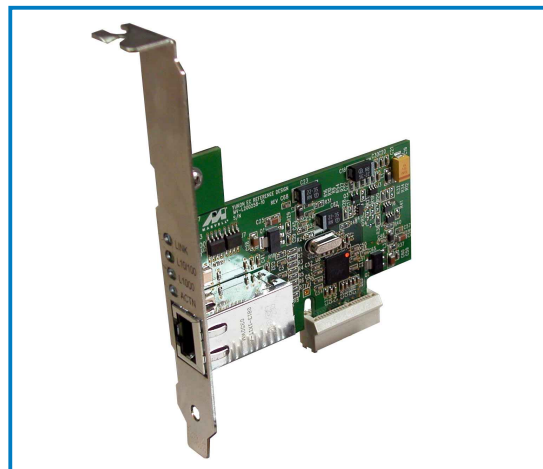

2.6 Jumpers

1. Clear RTC RAM (CLRTC1)

This jumper allows you to clear the Real Time Clock (RTC) RAM in CMOS. You can clear the CMOS memory of date, time, and system setup parameters by erasing the CMOS RTC RAM data. The onboard button cell battery powers the RAM data in CMOS, which include system setup information such as system passwords.

To erase the RTC RAM:

1. Turn OFF the computer and unplug the power cord.
2. Remove the onboard battery.
3. Move the jumper cap from pins 1-2 (default) to pins 2-3. Keep the cap on pins 2-3 for about 5~10 seconds, then move the cap back to pins 1-2.
4. Re-install the battery.
5. Plug the power cord and turn ON the computer.
6. Hold down the key during the boot process and enter BIOS setup to re-enter data.



Except when clearing the RTC RAM, never remove the cap on CLRTC jumper default position. Removing the cap will cause system boot failure!

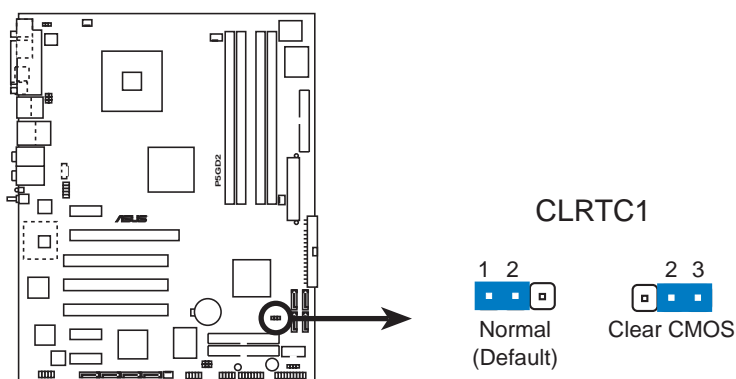

P5GD2 Deluxe Clear RTC RAM



You do not need to clear the RTC when the system hangs due to overclocking. For system failure due to overclocking, use the C.P.R. (CPU Parameter Recall) feature. Shut down and reboot the system so the BIOS can automatically reset parameter settings to default values.

2. USB device wake-up (3-pin USBPW12, USBPW34, USBPW56, USBPW78)

Set these jumpers to +5V to wake up the computer from S1 sleep mode (CPU stopped, DRAM refreshed, system running in low power mode) using the connected USB devices. Set to +5VSB to wake up from S3 and S4 sleep modes (no power to CPU, DRAM in slow refresh, power supply in reduced power mode).

The USBPW12 and USBPW34 jumpers are for the rear USB ports. The USBPW56 and USBPW78 jumper is for the internal USB connectors that you can connect to additional USB ports.

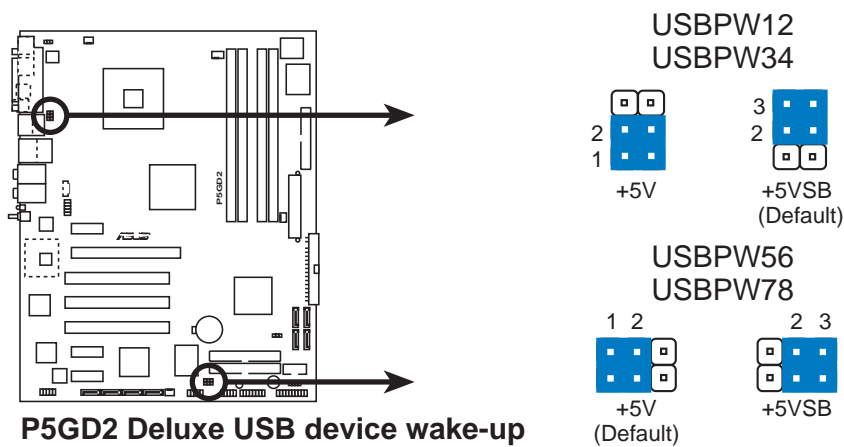

- The USB device wake-up feature requires a power supply that can provide 500mA on the +5VSB lead for each USB port; otherwise, the system would not power up.
- The total current consumed must NOT exceed the power supply capability (+5VSB) whether under normal condition or in sleep mode.

3. Keyboard power (3-pin KBPWR1)

This jumper allows you to enable or disable the keyboard wake-up feature. Set this jumper to pins 2-3 (+5VSB) if you wish to wake up the computer when you press a key on the keyboard (the default is the Space Bar). This feature requires an ATX power supply that can supply at least 1A on the +5VSB lead, and a corresponding setting in the BIOS.

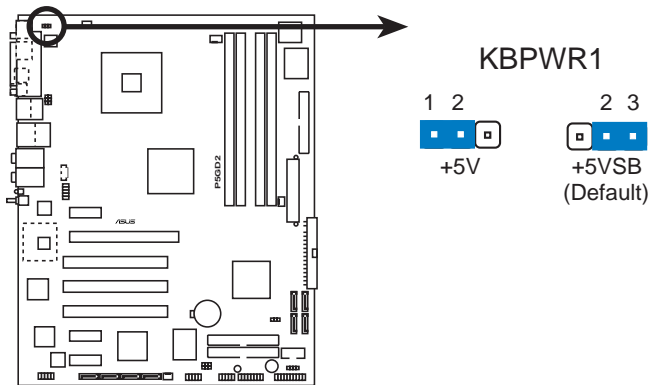

P5GD2 Deluxe Keyboard power setting

2.7 Connectors

2.7.1 Rear panel connectors

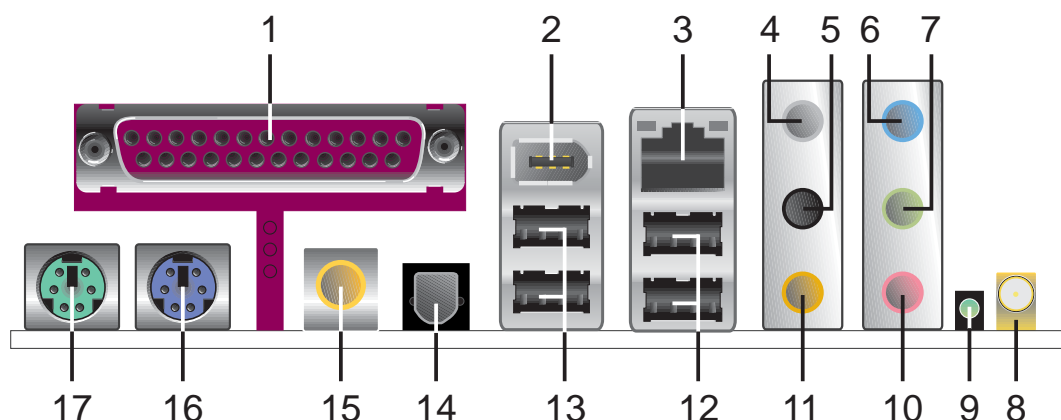

1. **Parallel port.** This 25-pin port connects a parallel printer, a scanner, or other devices.
2. **IEEE 1394a port.** This 6-pin IEEE 1394 port provides high-speed connectivity for audio/video devices, storage peripherals, PCs, or portable devices.
3. **LAN RJ-45 port.** This port allows Gigabit connection to a Local Area Network (LAN) through a network hub. Refer to the table below for the LAN port LED indications.

LAN port LED indications

ACT/LINK LED		SPEED LED	
Status	Description	Status	Description
OFF	No link	OFF	10 Mbps connection
GREEN	Linked	ORANGE	100 Mbps connection
BLINKING	Data activity	GREEN	1 Gbps connection

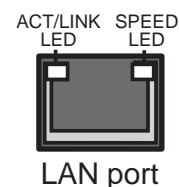

4. **Rear Speaker Out port (gray).** This port connects the rear speakers on a 4-channel, 6-channel, or 8-channel audio configuration.
5. **Side Speaker Out port (black).** This port connects the side speakers in an 8-channel audio configuration.
6. **Line In port (light blue).** This port connects the tape, CD, DVD player, or other audio sources.
7. **Line Out port (lime).** This port connects a headphone or a speaker. In 4-channel, 6-channel, and 8-channel configuration, the function of this port becomes Front Speaker Out.



Refer to the audio configuration table on the next page for the function of the audio ports in 2, 4, 6, or 8-channel configuration.

8. **WiFi-g™ antenna port.** This port connects to the optional dipolar antenna for the onboard ASUS WiFi-g™ solution. (Wireless Edition only)
9. **Wireless LAN data transmission LED.** This green **AIR** LED indicates the data transmission status of the onboard wireless LAN adapter. Refer to the table below for the LED indications. (Wireless Edition only)

Wireless LAN LED indications

Status	Indication
On	The onboard WiFi-g™ is on but has no data activity.
Off	The onboard WiFi-g™ card is off.
Flashing	The onboard WiFi-g™ card is transmitting and/or receiving data.

10. **Microphone port (pink).** This port connects a microphone.
11. **Center/Subwoofer port (yellow orange).** This port connects the center/subwoofer speakers.

Audio 2, 4, 6, or 8-channel configuration

Port	Headset 2-channel	4-channel	6-channel	8-channel
Light Blue	Line In	Line In	Line In	Line In
Lime	Line Out	Front Speaker Out	Front Speaker Out	Front Speaker Out
Pink	Mic In	Mic In	Mic In	Mic In
Gray	•	Rear Speaker Out	Rear Speaker Out	Rear Speaker Out
Black	•	•	•	Side Speaker Out
Yellow Orange	•	•	Center/Subwoofer	Center/Subwoofer

12. **USB 2.0 ports 3 and 4.** These two 4-pin Universal Serial Bus (USB) ports are available for connecting USB 2.0 devices.
13. **USB 2.0 ports 1 and 2.** These two 4-pin Universal Serial Bus (USB) ports are available for connecting USB 2.0 devices.
14. **Optical S/PDIF Out port.** This port connects an external audio output device via an optical S/PDIF cable.
15. **Coaxial S/PDIF Out port.** This port connects an external audio output device via a coaxial S/PDIF cable.
16. **PS/2 keyboard port (purple).** This port is for a PS/2 keyboard.
17. **PS/2 mouse port (green).** This port is for a PS/2 mouse.

2.7.2 Internal connectors

1. Floppy disk drive connector (34-1 pin FLOPPY)

This connector is for the provided floppy disk drive (FDD) signal cable. Insert one end of the cable to this connector, then connect the other end to the signal connector at the back of the floppy disk drive.



The Pin 5 on the connector is removed to prevent incorrect cable connection when using an FDD cable with a covered Pin 5.

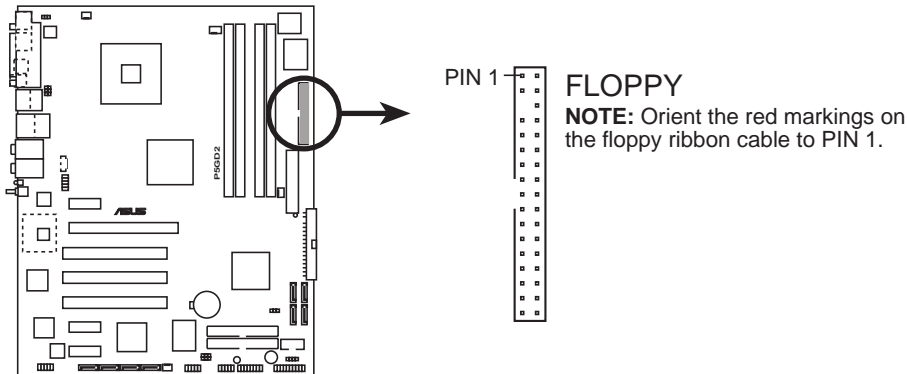

P5GD2 Deluxe Floppy disk drive connector

2. Primary IDE connector (40-1 pin PRI_IDE1)

This connector is for an Ultra DMA 100/66 signal cable. The Ultra DMA 100/66 signal cable has three connectors: a blue connector for the primary IDE connector on the motherboard, a black connector for an Ultra DMA 100/66 IDE slave device (optical drive/hard disk drive), and a gray connector for an Ultra DMA 100/66 IDE master device (hard disk drive). If you install two hard disk drives, you must configure the second drive as a slave device by setting its jumper accordingly. Refer to the hard disk documentation for the jumper settings.



- The Pin 20 on the IDE connector is removed to match the covered hole on the Ultra DMA cable connector. This prevents incorrect insertion when you connect the IDE cable.
- Use the 80-conductor IDE cable for Ultra DMA 100/66 IDE devices.

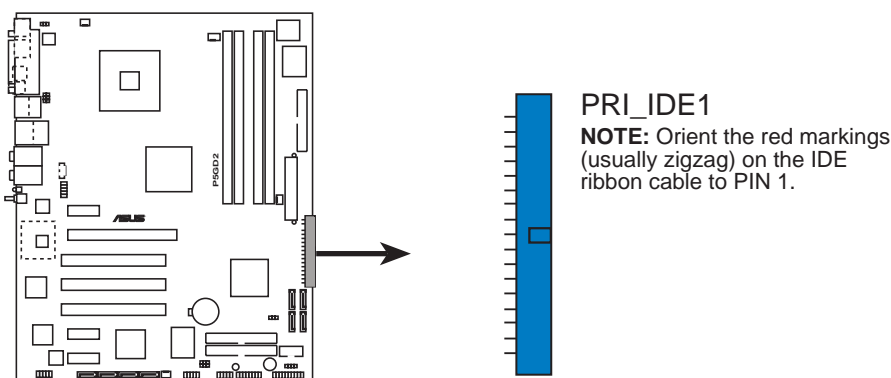

P5GD2 Deluxe IDE connectors

3. IDE RAID connectors (40-1 pin PRI_RAID1 [red], SEC_RAID1 [red])

These connectors are for Ultra ATA 133/100/66 signal cables. These connectors support up to four IDE hard disk drives that can be configured as a disk array through the onboard IDE RAID controller. Refer to Chapter 5 for details on how to set up RAID configurations.



These connectors are set to IDE mode by default. In IDE mode, you can connect IDE devices to these connectors such as boot/data hard disk drives or optical drives. If you intend to create an IDE RAID set using these connectors, set the **ITE8212F Controller** item in the BIOS to RAID Mode. See section “4.4.6 Onboard Devices Configuration” for details.

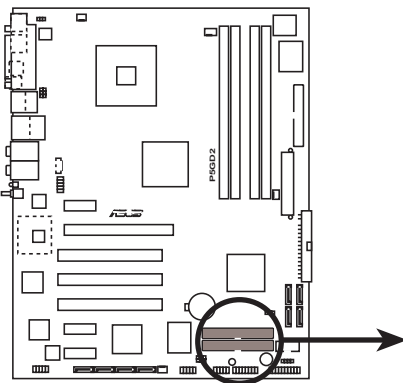

P5GD2 Deluxe RAID connectors

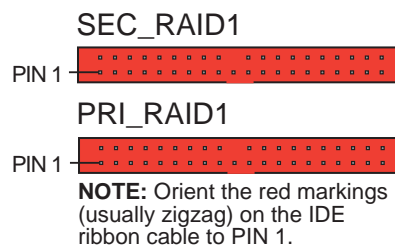

- Before creating a RAID set using Ultra ATA hard disks, make sure that you have connected the Ultra ATA signal cable and installed Ultra ATA 133/100/66 hard disk drives.
- The system automatically assigns the boot sequence of ATAPI devices connected to the IDE RAID connectors.
- The ITE® 8212F RAID 1 configuration supports a maximum of 2 Ultra ATA hard disk drives only. Make sure to set both drives either as Master or Slave before configuring a RAID 1 set.

4. Serial ATA connectors (7-pin SATA1 [Red], SATA2 [Red], SATA3 [Black], SATA4 [Black])

These connectors are for the Serial ATA signal cables for Serial ATA hard disk drives.

If you installed Serial ATA hard disk drives, you can create a RAID 0 or RAID 1 configuration using the Intel® Matrix Storage Technology. Refer to Chapter 5 for details on how to set up Serial RAID configurations.



These connectors are set to Standard IDE configuration by default. In Standard IDE mode, you can connect Serial ATA boot/data hard disk drives to these connectors. If you intend to create a Serial ATA RAID set using these connectors, adjust the RAID controller setting in the BIOS Setup. See section “4.3.6 IDE Configuration” on page 4-15 for details.

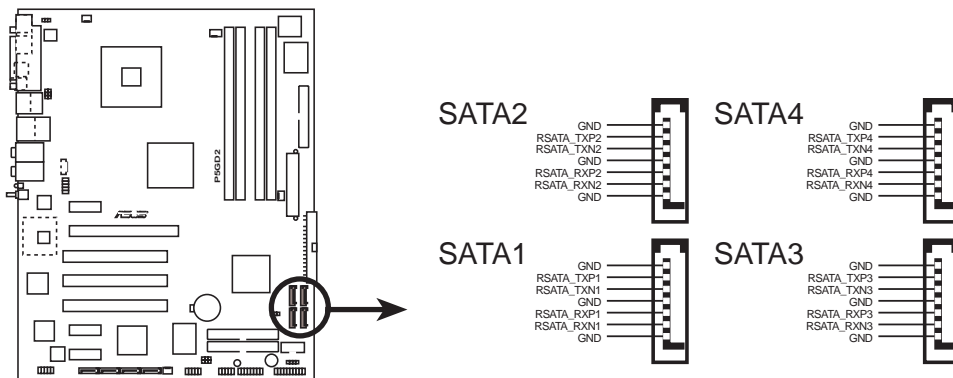

P5GD2 Deluxe SATA connectors



Important notes on Serial ATA

- These connectors support the Intel® Matrix Storage Technology.
- The Serial ATA RAID feature (RAID 0, RAID 1) is available only if you are using Windows® 2000/XP.
- Install the Windows® 2000 Service Pack 4 or the Windows® XP Service Pack1 when using Serial ATA.
- Use only a maximum of 2 ports for each RAID 0 or RAID 1 set.
- Plug your Serial ATA boot disk on the master port (SATA1 and SATA2) to support S3 function. Refer to the table below for details.

Serial ATA Master/Slave connectors

Connector	Setting	Color	Use
SATA1, SATA2	Master	Red	Boot disk
SATA3, SATA4	Slave	Black	Data disk

5. Serial ATA RAID connectors (7-pin SATA_RAID1, SATA_RAID2, SATA_RAID3, SATA_RAID4)

These connectors are for Serial ATA signal cables. These connectors support up to four Serial ATA hard disk drives that can be configured as a disk array through the onboard SATA RAID controller. Refer to Chapter 5 for details on how to set up Serial ATA RAID configurations.

You can configure a RAID 0, RAID 1, RAID 10, RAID 5 or JBOD sets on these connectors.

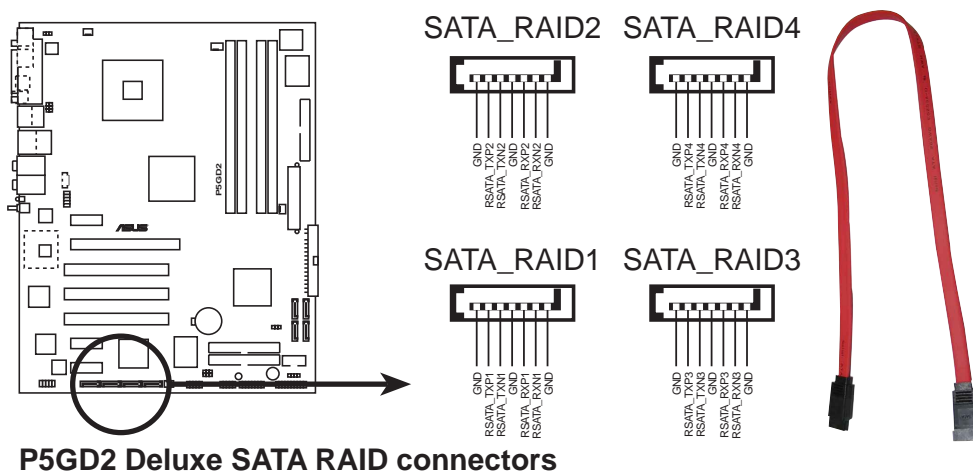

- These connectors are set to SATA mode by default. See section “4.4.6 Onboard Devices Configuration” for details on changing the connectors configuration to IDE mode.
- When in IDE mode, you can connect Serial ATA boot/data hard disk drives to any of these connectors.
- Before creating a RAID configuration, make sure that you have connected the Serial ATA cables to these connectors and have installed the Serial ATA hard disk drives; otherwise, you cannot enter the Silicon Image RAID utility and Serial ATA BIOS setup during POST.
- You can only create a RAID 5 and JBOD configuration using the SATALink™ Serial ATA RAID Management software. See section “5.2.2 Silicon Image RAID Configurations” for details.
- The RAID 5 driver is not Windows Hardware Quality Labs (WHQL) certified.
- All four Serial ATA ports are master ports. You can install Serial ATA boot disks to any of these ports.

6. CPU, Chassis, and Power fan connectors (4-pin CPU_FAN1, 3-pin PWR_FAN1, 3-pin CHA_FAN1, CHA_FAN2)

The fan connectors support cooling fans of 350mA~2000mA (24 W max.) or a total of 1A~3.48A (41.76 W max.) at +12V. Connect the fan cables to the fan connectors on the motherboard, making sure that the black wire of each cable matches the ground pin of the connector.



- Do not forget to connect the fan cables to the fan connectors. Lack of sufficient air flow inside the system may damage the motherboard components. These are not jumpers! DO NOT place jumper caps on the fan connectors!
- Only the CPU_FAN1 and CHA_FAN1 connectors support the ASUS Q-Fan 2 features.

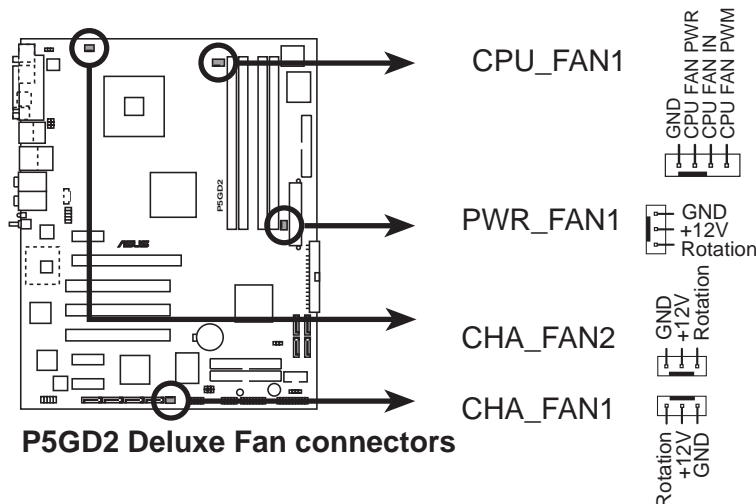

7. Serial port connector (10-1 pin COM1)

This connector is for a serial (COM) port. Connect the serial port module cable to this connector, then install the module to a slot opening at the back of the system chassis.

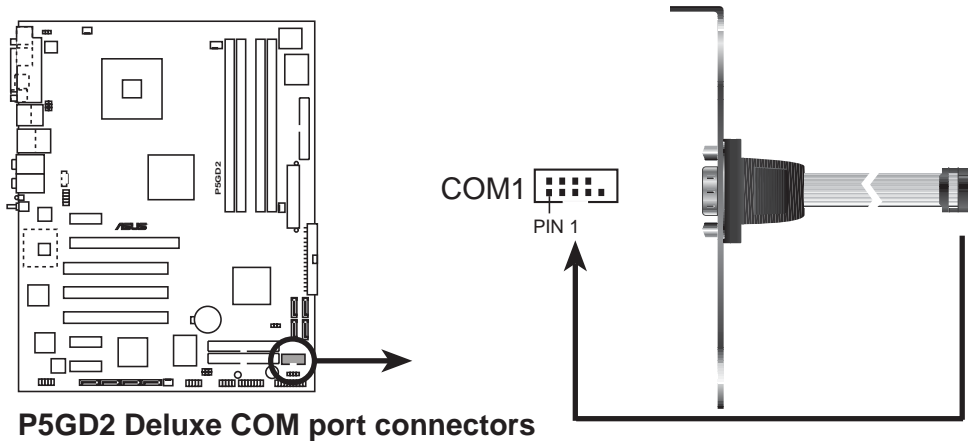

P5GD2 Deluxe COM port connectors

8. USB connectors (10-1 pin USB56, USB78)

These connectors are for USB 2.0 ports. Connect the USB/GAME module cable to any of these connectors, then install the module to a slot opening at the back of the system chassis. These USB connectors comply with USB 2.0 specification that supports up to 480 Mbps connection speed.

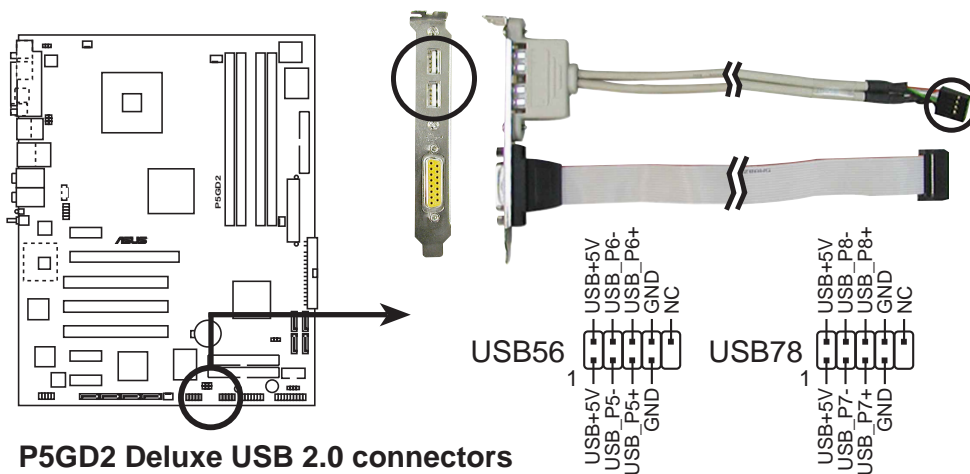

P5GD2 Deluxe USB 2.0 connectors



Never connect a **1394 cable** to the USB connectors. Doing so will damage the motherboard!

9. ATX power connectors (24-pin EATXPWR1, 4-pin ATX12V1)

These connectors are for an ATX power supply. The plugs from the power supply are designed to fit these connectors in only one orientation. Find the proper orientation and push down firmly until the connectors completely fit.



- Use of a Specification 2.0 -compliant 24-pin ATX 12 V power supply unit (PSU) that provides a minimum power of 350 W is recommended for a fully-configured system.
- Do not forget to connect the 4-pin ATX +12 V power plug; otherwise, the system will not boot up.
- Use of a PSU with a higher power output is recommended when configuring a system with more power-consuming devices. The system may become unstable or may not boot up if the power is inadequate.
- The ATX 12 V Spec. 2.0 350 W PSU passed the motherboard power requirement test with the following configuration:

CPU	:	Intel® Pentium® 4 3.6 GHz
Memory	:	512 MB DDR2 (x 4)
Graphics card	:	PCI Express x16 Nvidia EN5900
Parallel ATA devices	:	IDE hard disk drive (x 2)
Serial ATA device	:	SATA hard disk drive
Optical drives	:	CD-ROM (x 2)
SCSI devices	:	SCSI card and SCSI hard disk drive

- You must install a PSU with a higher power rating if you intend to install additional devices.

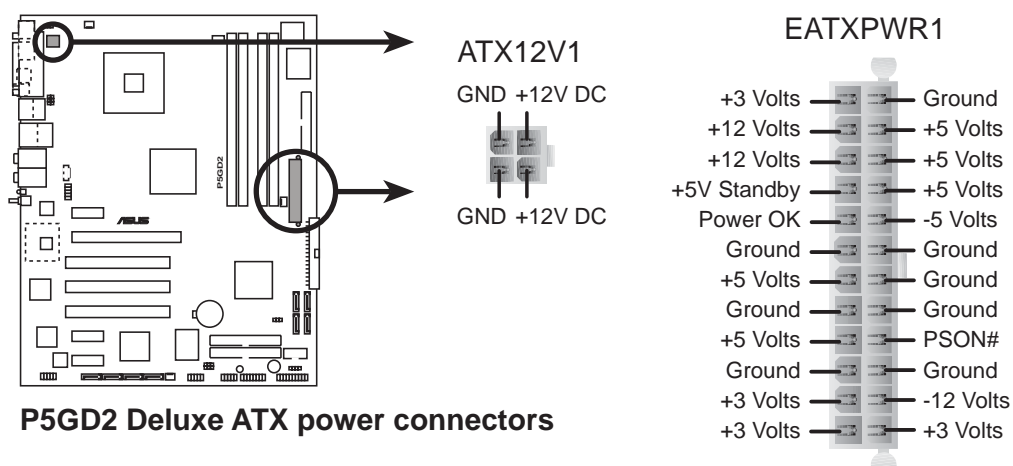

10. Optical drive audio connector (4-pin CD)

This connector is for the 4-pin audio cable that connects to the audio connector at the back of the optical drive.

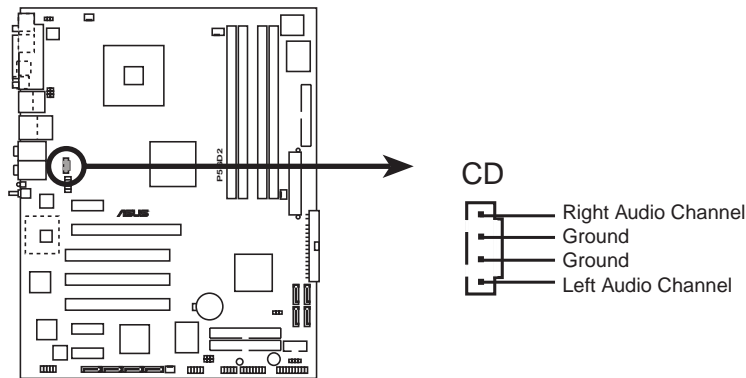

P5GD2 Deluxe CD audio connector

11. GAME/MIDI port connector (16-1 pin GAME1)

This connector is for a GAME/MIDI port. Connect the USB/GAME module cable to this connector, then install the module to a slot opening at the back of the system chassis. The GAME/MIDI port connects a joystick or game pad for playing games, and MIDI devices for playing or editing audio files.

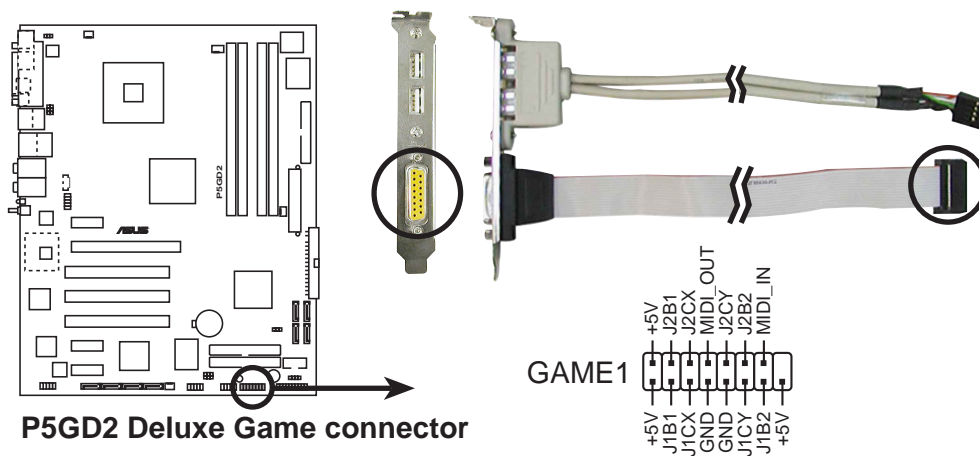

P5GD2 Deluxe Game connector

12. Chassis intrusion connector (4-1 pin CHASSIS1)

This connector is for a chassis-mounted intrusion detection sensor or switch. Connect one end of the chassis intrusion sensor or switch cable to this connector. The chassis intrusion sensor or switch sends a high-level signal to this connector when a chassis component is removed or replaced. The signal is then generated as a chassis intrusion event.

By default, the pins labeled “Chassis Signal” and “Ground” are shorted with a jumper cap. Remove the jumper caps only when you intend to use the chassis intrusion detection feature.

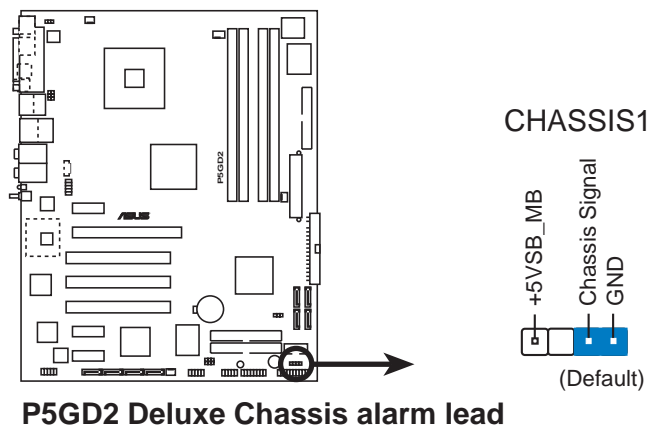

13. Front panel audio connector (10-1 pin AAFP)

This connector is for a chassis-mounted front panel audio I/O module that supports either HD Audio or legacy AC '97 audio standard. Connect one end of the front panel audio I/O module cable to this connector.

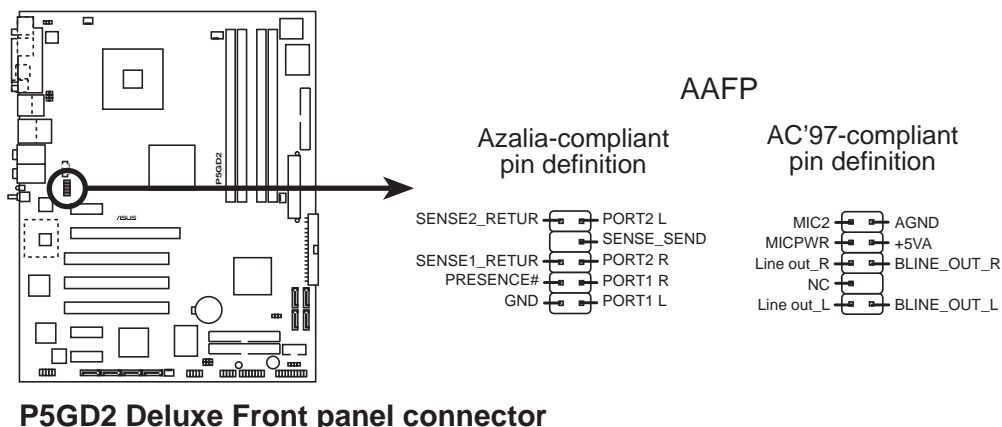

- Use a chassis that provides a high-definition audio front panel audio I/O to use the high-definition audio features.
- The default setting of this connector is legacy AC'97 audio, if you want to use the High-Definition (Azalia) audio features, set the **Front Panel Support Type** in the BIOS to Azalia. See page 4-26.

14. System panel connector (20-pin PANEL1)

This connector supports several chassis-mounted functions.

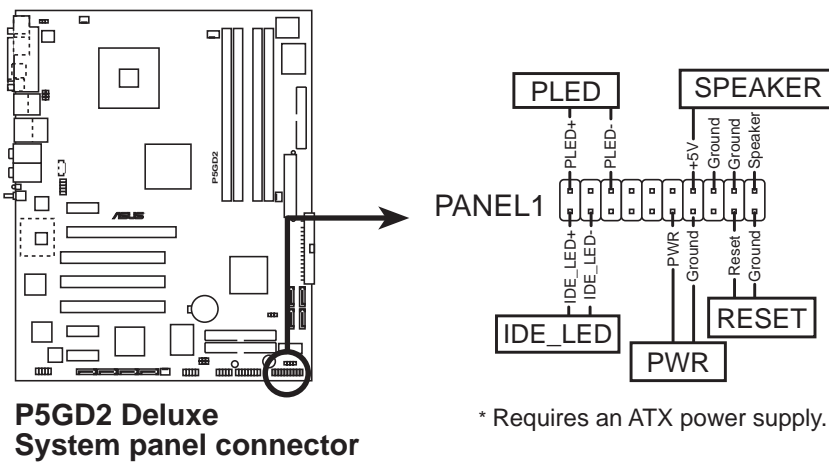

The system panel connector is color-coded for easy connection. Refer to the connector description below for details.

- **System power LED (Green 3-pin PLED)**
This 3-pin connector is for the system power LED. Connect the chassis power LED cable to this connector. The system power LED lights up when you turn on the system power, and blinks when the system is in sleep mode.
- **Hard disk drive activity (Red 2-pin IDE_LED)**
This 2-pin connector is for the HDD Activity LED. Connect the HDD Activity LED cable to this connector. The IDE LED lights up or flashes when data is read from or written to the HDD.
- **System warning speaker (Orange 4-pin SPEAKER)**
This 4-pin connector is for the chassis-mounted system warning speaker. The speaker allows you to hear system beeps and warnings.
- **Power/Soft-off button (Yellow 2-pin PWR)**
This connector is for the system power button. Pressing the power button turns the system ON or puts the system in SLEEP or SOFT-OFF mode depending on the BIOS settings. Pressing the power switch for more than four seconds while the system is ON turns the system OFF.
- **Reset button (Blue 2-pin RESET)**
This 2-pin connector is for the chassis-mounted reset button for system reboot without turning off the system power.

This chapter describes the power up sequence, the vocal POST messages, and ways of shutting down the system.

Powering up

Chapter summary

3.1	Starting up for the first time	3-1
3.2	Powering off the computer	3-2
3.3	ASUS POST Reporter™	3-3

3.1 Starting up for the first time

1. After making all the connections, replace the system case cover.
2. Be sure that all switches are off.
3. Connect the power cord to the power connector at the back of the system chassis.
4. Connect the power cord to a power outlet that is equipped with a surge protector.
5. Turn on the devices in the following order:
 - a. Monitor
 - b. External SCSI devices (starting with the last device on the chain)
 - c. System power
6. After applying power, the system power LED on the system front panel case lights up. For systems with ATX power supplies, the system LED lights up when you press the ATX power button. If your monitor complies with “green” standards or if it has a “power standby” feature, the monitor LED may light up or switch between orange and green after the system LED turns on.

The system then runs the power-on self tests or POST. While the tests are running, the BIOS beeps (see BIOS beep codes table below) or additional messages appear on the screen. If you do not see anything within 30 seconds from the time you turned on the power, the system may have failed a power-on test. Check the jumper settings and connections or call your retailer for assistance.

AMI BIOS beep codes

Beep Description	Error
One beep	Keyboard controller error Refresh Time error No master drive detected
Two continuous beeps followed by two short beeps	Floppy controller failure
Two continuous beeps followed by four short beeps	Hardware component failure

7. At power on, hold down the <Delete> key to enter the BIOS Setup. Follow the instructions in Chapter 4.

3.2 Powering off the computer

3.2.1 Using the OS shut down function

If you are using Windows® 2000:

1. Click the **Start** button then click **Shut Down...**
2. Make sure that the **Shut Down** option button is selected, then click the **OK** button to shut down the computer.
3. The power supply should turn off after Windows® shuts down.

If you are using Windows® XP:

1. Click the **Start** button then select **Turn Off Computer.**
2. Click the **Turn Off** button to shut down the computer.
3. The power supply should turn off after Windows® shuts down.

3.2.2 Using the dual function power switch

While the system is ON, pressing the power switch for less than four seconds puts the system to sleep mode or to soft-off mode, depending on the BIOS setting. Pressing the power switch for more than four seconds lets the system enter the soft-off mode regardless of the BIOS setting. Refer to section “4.5 Power Menu” in Chapter 4 for details.

3.3 ASUS POST Reporter™

This motherboard includes the Winbond speech controller to support a special feature called the ASUS POST Reporter™. This feature lets you hear vocal messages during POST that alerts you of system events and boot status. In case of a boot failure, you will hear the specific cause of the problem.

These POST messages are customizable using the Winbond Voice Editor software that came with your package. You can record your own messages to replace the default messages.

3.3.1 Vocal POST messages

Following is a list of the default POST messages and the corresponding actions you can take:

POST Message	Action
No CPU installed	<ul style="list-style-type: none">• Install a supported processor to the CPU socket. See section “2.3 Central Processing Unit (CPU)” for details.
System failed CPU test	<ul style="list-style-type: none">• Check the CPU if properly installed.• Call ASUS technical support for assistance. See the ASUS contact information on the inside front cover of this user guide.
System failed memory test	<ul style="list-style-type: none">• Install supported DDR2 DIMMs into the memory sockets.• Check if the DIMMs on the DIMM sockets are properly installed.• Make sure that your DIMMs are not defective.• Refer to section “2.4 System memory” for instructions on installing a DIMM.
System failed VGA test	<ul style="list-style-type: none">• Install a PCI graphics card into one of the PCI slots, or a PCI Express AGP card into the PCI Express x16 slot.• Make sure that your graphics card is not defective.
System failed due to CPU	<ul style="list-style-type: none">• Check your CPU overclocking settings in the BIOS setup and restore the default CPU parameters.
No keyboard detected	<ul style="list-style-type: none">• Check if your keyboard is properly connected to the purple PS/2 connector on the rear panel.• See section “2.7.1 Rear panel connectors” for the location of the connector.
No IDE hard disk detected	<ul style="list-style-type: none">• Make sure you have connected an IDE hard disk drive to one of the IDE connectors on the motherboard.

POST Message	Action
CPU temperature too high	<ul style="list-style-type: none"> • Check if the CPU fan is working properly.
CPU fan failed	<ul style="list-style-type: none"> • Check the CPU fan and make sure it turns on after you apply power to the system. • Make sure that your CPU fan supports the fan speed detection function.
CPU voltage out of range	<ul style="list-style-type: none"> • Check your power supply and make sure it is not defective. • Call ASUS technical support for assistance. See the “ASUS contact information” on the inside front cover of this user guide.
Computer now booting from operating system	<ul style="list-style-type: none"> • No action required



You can enable or disable the ASUS POST Reporter™ in the **Speech Configuration** option in the BIOS setup. See section 4.4.8 for details.

3.3.2 Winbond Voice Editor

The Winbond Voice Editor software allows you to customize the vocal POST messages. You can install this application from the support CD.



To avoid conflicts, do not run the Winbond Voice Editor while running the ASUS PC Probe application.

Launching the Voice Editor

You can launch the program from the Windows® desktop by clicking **Start > All Programs > Winbond Voice Editor > Voice Editor**.

The Winbond Voice Editor screen appears.

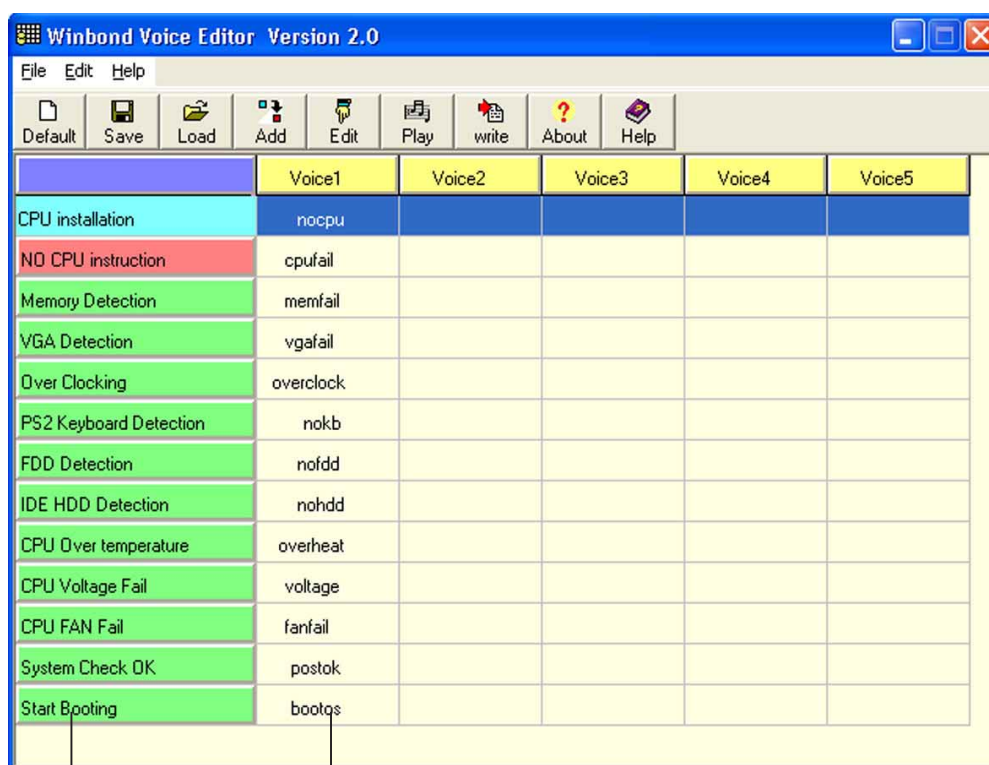

POST Events Default Messages

Playing the default wave files

To play the default wave files, simply click on a POST event on the left side of the screen, then click the Play button.



The default language setting is English.

Changing the default language

To change the default language:

1. Click the **Load** button from the Voice Editor main window. A window with the available languages appears.

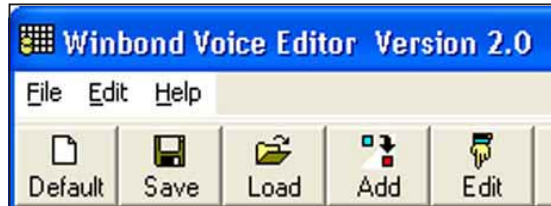

2. Select your desired language, then click **Open**.

The event messages for the language you selected appear on the Voice Editor main window.

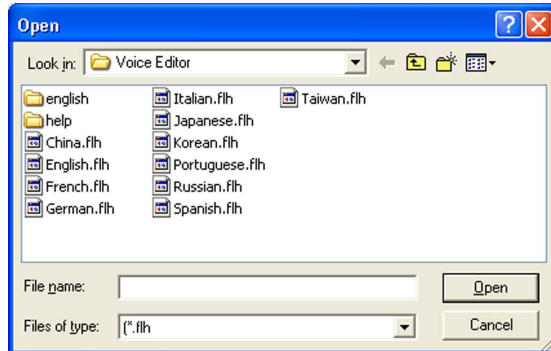

Not all events on some languages have a corresponding message due to file size constraints.

3. Click the **Write** button from the Voice Editor main window to update the EEPROM.
4. Click **Yes** to confirm.

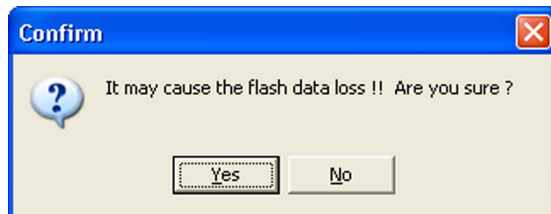

The next time you boot your computer, the ASUS Post Reporter announces the messages in the selected language.

Customizing your POST messages

The Voice Editor application allows you to record your own POST messages if your language is not supported or if you wish to replace the pre-installed wave files.

To customize your POST messages.

1. Launch the Voice Editor application and note the list of POST events on the leftmost column of the screen.
2. Prepare your message for each event.
3. Use a recording software (e.g. Windows® Recorder) to record your messages, then save the messages as wave files (.WAV).



- The total compressed size for all the wave files must not exceed 1Mbit, so keep your messages as short as possible.
- To keep file sizes small, save your files at a low quality. For example, use 8-bit, mono quality at 22Khz sampling rate.
- Create a separate folder for your wave files so you can locate them easily.

4. From the Voice Editor screen, click the **Add** button to display the **Add Wave File** window.
5. Copy the wave files that you recorded to the database, then close the window when done.

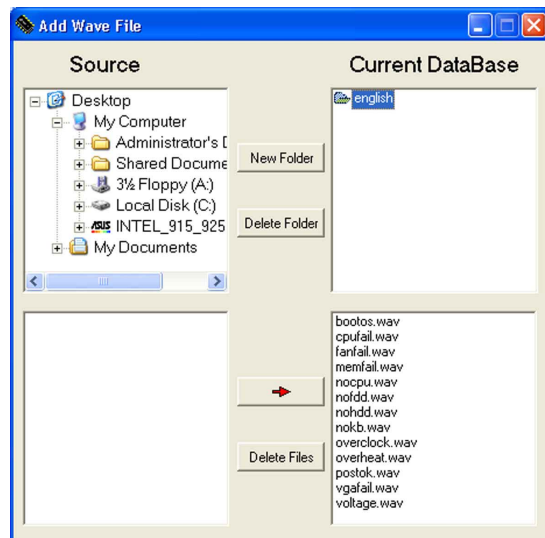

6. Select a POST event on the Voice Editor main window, then click the **Edit** button. The **Event Sound Editor** window appears.
7. Locate and select your wave file for the event, then click on the arrow opposite Voice1. The file you select appears on the space next to it.
8. Click **OK** to return to the Voice Editor main window.
9. Do steps 6 to 8 for the other events.

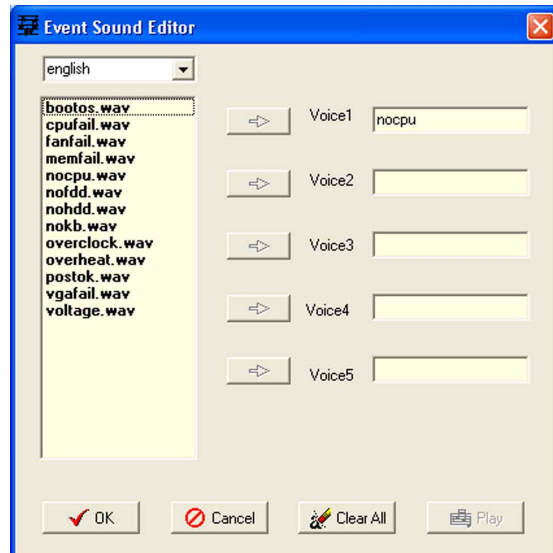

10. When done, click **Save**. A window appears prompting you to save your configuration.
11. Type a file name with an **.flh** extension, then click Save.

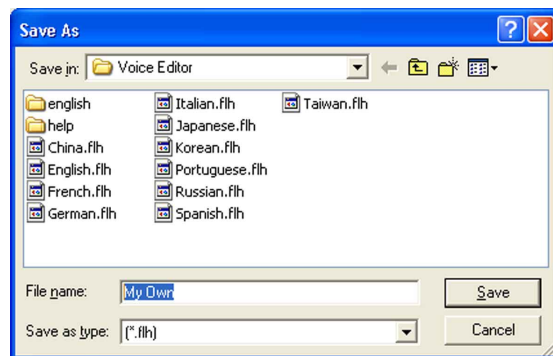

12. Click the **Write** button to compress the file and copy into the EEPROM.
13. Click **Yes** on the confirmation window that appears.

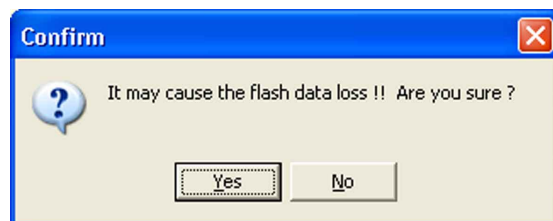

If you receive an error message telling you that the files exceed the total allowable size, do any or all of the following:

- Shorten your messages.
- Save the wave files at a lower quality
- Do not include seldom-used events like FDD Detection, IDE HDD Detection, etc.

This chapter tells how to change the system settings through the BIOS Setup menus. Detailed descriptions of the BIOS parameters are also provided.

BIOS setup

Chapter summary

4.1	Managing and updating your BIOS	4-1
4.2	BIOS setup program	4-10
4.3	Main menu	4-13
4.4	Advanced menu	4-18
4.5	Power menu	4-30
4.6	Boot menu	4-35
4.7	Exit menu	4-39

4.1 Managing and updating your BIOS

The following utilities allow you to manage and update the motherboard Basic Input/Output System (BIOS) setup.

1. **ASUS AFUDOS** (Updates the BIOS in DOS mode using a bootable floppy disk.)
2. **ASUS EZ Flash** (Updates the BIOS using a floppy disk during POST.)
3. **ASUS CrashFree BIOS 2** (Updates the BIOS using a bootable floppy disk or the motherboard support CD when the BIOS file fails or gets corrupted.)
4. **ASUS Update** (Updates the BIOS in Windows® environment.)

Refer to the corresponding sections for details on these utilities.



Save a copy of the original motherboard BIOS file to a bootable floppy disk in case you need to restore the BIOS in the future. Copy the original motherboard BIOS using the ASUS Update or AFUDOS utilities.

4.1.1 Creating a bootable floppy disk

1. Do either one of the following to create a bootable floppy disk.

DOS environment

- a. Insert a 1.44MB floppy disk into the drive.
- b. At the DOS prompt, type `format A:/s` then press <Enter>.

Windows® XP environment

- a. Insert a 1.44 MB floppy disk to the floppy disk drive.
- b. Click **Start** from the Windows® desktop, then select **My Computer**.
- c. Select the 3 1/2 Floppy Drive icon.
- d. Click **File** from the menu, then select **Format**. A **Format 3 1/2 Floppy Disk** window appears.
- e. Select **Create an MS-DOS startup disk** from the format options field, then click **Start**.

Windows® 2000 environment

To create a set of boot disks for Windows® 2000:

- a. Insert a formatted, high density 1.44 MB floppy disk into the drive.
- b. Insert the Windows® 2000 CD to the optical drive.
- c. Click **Start**, then select **Run**.

- d. From the Open field, type
`D:\bootdisk\makeboot a:`
assuming that D: is your optical drive.
 - e. Press <Enter>, then follow screen instructions to continue.
2. Copy the original or the latest motherboard BIOS file to the bootable floppy disk.

4.1.2 ASUS EZ Flash utility

The ASUS EZ Flash feature allows you to update the BIOS without having to go through the long process of booting from a floppy disk and using a DOS-based utility. The EZ Flash utility is built-in the BIOS chip so it is accessible by pressing <Alt> + <F2> during the Power-On Self Tests (POST).

To update the BIOS using EZ Flash:

1. Visit the ASUS website (www.asus.com) to download the latest BIOS file for the motherboard and rename the same to **P5GD2D.ROM**.
2. Save the BIOS file to a floppy disk, then restart the system.
3. Press <Alt> + <F2> during POST to display the following.

```
EZFlash starting BIOS update
Checking for floppy...
```

4. Insert the floppy disk that contains the BIOS file to the floppy disk drive. When the correct BIOS file is found, EZ Flash performs the BIOS update process and automatically reboots the system when done.

```
EZFlash starting BIOS update
Checking for floppy...
Floppy found!
Reading file "P5GD2D.ROM". Completed.
Start erasing.....|
Start programming...|
Flashed successfully. Rebooting.
```



- Do not shutdown or reset the system while updating the BIOS to prevent system boot failure!
- A “Floppy not found!” error message appears if there is no floppy disk in the drive. A “P5GD2D.ROM not found!” error message appears if the correct BIOS file is not found in the floppy disk. Make sure that you rename the BIOS file to P5GD2D.ROM.

4.1.3 AFUDOS utility

The AFUDOS utility allows you to update the BIOS file in DOS environment using a bootable floppy disk with the updated BIOS file. This utility also allows you to copy the current BIOS file that you can use as backup when the BIOS fails or gets corrupted during the updating process.

Copying the current BIOS

To copy the current BIOS file using the AFUDOS utility:



- Make sure that the floppy disk is not write-protected and has at least 1.2 MB free space to save the file.
- The succeeding BIOS screens are for reference only. The actual BIOS screen displays may not be exactly the same as shown.

1. Copy the AFUDOS utility (afudos.exe) from the motherboard support CD to the bootable floppy disk you created earlier.
2. Boot the system in DOS mode, then at the prompt type:

```
afudos /o[filename]
```

where the [filename] is any user-assigned filename not more than eight alphanumeric characters for the main filename and three alphanumeric characters for the extension name.

```
A:\>afudos /oOLDBIOS1.ROM
```

Main filename Extension name

3. Press <Enter>. The utility copies the current BIOS file to the floppy disk.

```
A:\>afudos /oOLDBIOS1.ROM
AMI Firmware Update Utility - Version 1.19(ASUS V2.07(03.11.24BB))
Copyright (C) 2003 American Megatrends, Inc. All rights reserved.
  Reading flash ..... done
  Write to file ...ok
A:\>
```

The utility returns to the DOS prompt after copying the current BIOS file.

- The utility returns to the DOS prompt after the BIOS update process is completed. Reboot the system from the hard disk drive.

```

A:\>afudos /iP5GD2D.ROM
AMI Firmware Update Utility - Version 1.19(ASUS V2.07(03.11.24BB))
Copyright (C) 2003 American Megatrends, Inc. All rights reserved.

WARNING!! Do not turn off power during flash BIOS
Reading file ..... done
Reading flash .... done
Search bootblock version:
0% ████████████████████████████████████████████████████████████████ 100%

Advance Check.....
Erasing flash ..... done
Writing flash ..... done
Verifying flash ... done

Please restart your computer

A:\>

```

4.1.4 ASUS CrashFree BIOS 2 utility

The ASUS CrashFree BIOS 2 is an auto recovery tool that allows you to restore the BIOS file when it fails or gets corrupted during the updating process. You can update a corrupted BIOS file using the motherboard support CD or the floppy disk that contains the updated BIOS file.



- Prepare the motherboard support CD or the floppy disk containing the updated motherboard BIOS before using this utility.
- Make sure that you rename the original or updated BIOS file in the floppy disk to **P5GD2D.ROM**.

Recovering the BIOS from a floppy disk

To recover the BIOS from a floppy disk:

- Turn on the system.
- Insert the floppy disk with the original or updated BIOS file to the floppy disk drive.
- The utility displays the following message and automatically checks the floppy disk for the original or updated BIOS file.

```

Bad BIOS checksum. Starting BIOS recovery...
Checking for floppy...

```

When found, the utility reads the BIOS file and starts flashing the corrupted BIOS file.

```
Bad BIOS checksum. Starting BIOS recovery...
Checking for floppy...
Floppy found!
Reading file "P5GD2D.ROM". Completed.
Start flashing...
```



DO NOT shut down or reset the system while updating the BIOS! Doing so can cause system boot failure!

4. Restart the system after the utility completes the updating process.

Recovering the BIOS from the support CD

To recover the BIOS from the support CD:

1. Remove any floppy disk from the floppy disk drive, then turn on the system.
2. Insert the support CD to the optical drive.
3. The utility displays the following message and automatically checks the floppy disk for the original or updated BIOS file.

```
Bad BIOS checksum. Starting BIOS recovery...
Checking for floppy...
```

When no floppy disk is found, the utility automatically checks the optical drive for the original or updated BIOS file. The utility then updates the corrupted BIOS file.

```
Bad BIOS checksum. Starting BIOS recovery...
Checking for floppy...
Floppy not found!
Checking for CD-ROM...
CD-ROM found!
Reading file "P5GD2D.ROM". Completed.
```



DO NOT shut down or reset the system while updating the BIOS! Doing so can cause system boot failure!

4. Restart the system after the utility completes the updating process.



The recovered BIOS may not be the latest BIOS version for this motherboard. Visit the ASUS website (www.asus.com) to download the latest BIOS file.

4.1.5 ASUS Update utility

The ASUS Update is a utility that allows you to manage, save, and update the motherboard BIOS in Windows® environment. The ASUS Update utility allows you to:

- Save the current BIOS file
- Download the latest BIOS file from the Internet
- Update the BIOS from an updated BIOS file
- Update the BIOS directly from the Internet, and
- View the BIOS version information.

This utility is available in the support CD that comes with the motherboard package.



ASUS Update requires an Internet connection either through a network or an Internet Service Provider (ISP).

Installing ASUS Update

To install ASUS Update:

1. Place the support CD in the optical drive. The **Drivers** menu appears.
2. Click the **Utilities** tab, then click **Install ASUS Update VX.XX.XX**. See page 5-3 for the **Utilities** screen menu.
3. The ASUS Update utility is copied to your system.



Quit all Windows® applications before you update the BIOS using this utility.

Updating the BIOS through the Internet

To update the BIOS through the Internet:

1. Launch the ASUS Update utility from the Windows® desktop by clicking **Start > Programs > ASUS > ASUSUpdate > ASUSUpdate**. The ASUS Update main window appears.

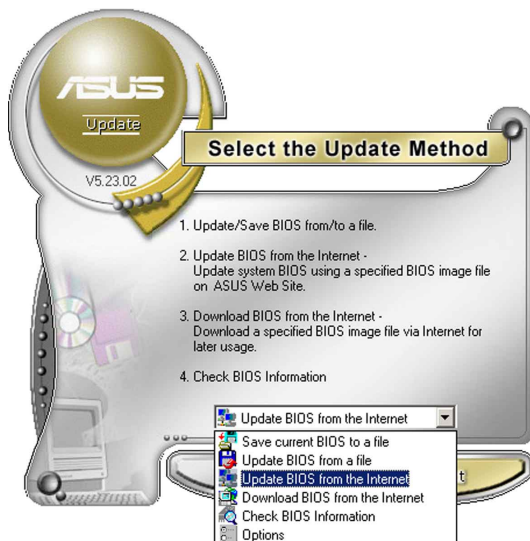
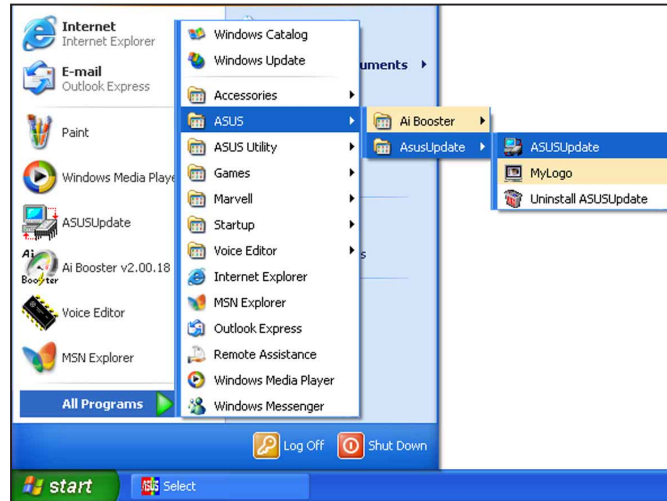

2. Select **Update BIOS from the Internet** option from the drop-down menu, then click **Next**.



3. Select the ASUS FTP site nearest you to avoid network traffic, or click **Auto Select**. Click **Next**.

- From the FTP site, select the BIOS version that you wish to download. Click Next.
- Follow the screen instructions to complete the update process.



The ASUS Update utility is capable of updating itself through the Internet. Always update the utility to avail all its features.

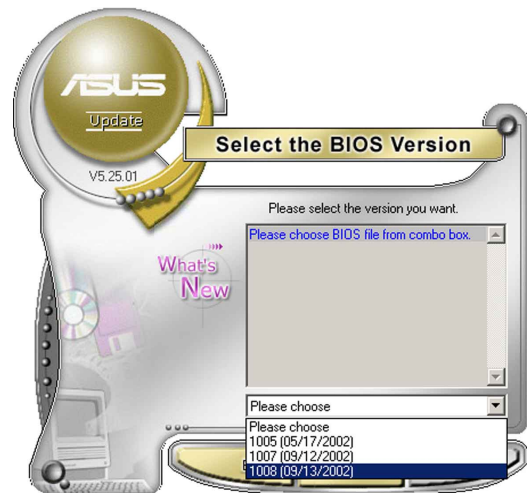

Updating the BIOS through a BIOS file

To update the BIOS through a BIOS file:

- Launch the ASUS Update utility from the Windows® desktop by clicking **Start > Programs > ASUS > ASUSUpdate > ASUSUpdate**. The ASUS Update main window appears.
- Select **Update BIOS from a file** option from the drop-down menu, then click **Next**.

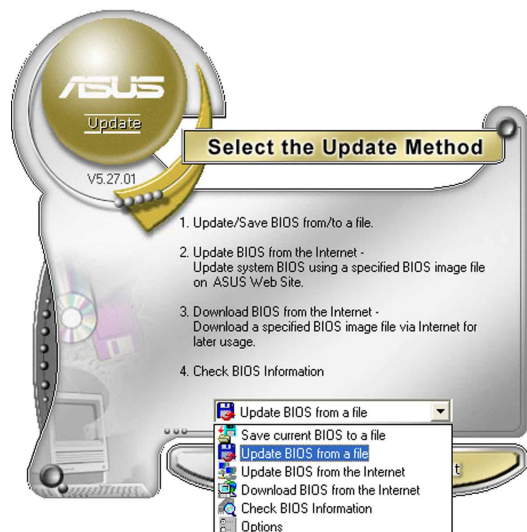

- Locate the BIOS file from the **Open** window, then click **Save**.
- Follow the screen instructions to complete the update process.

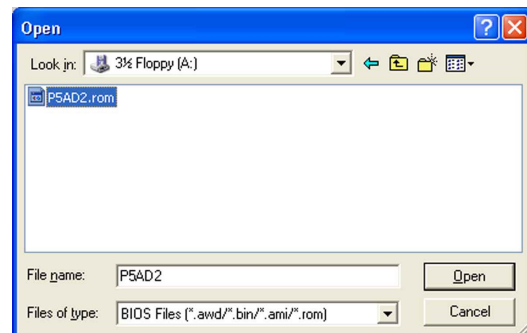

4.2 BIOS setup program

This motherboard supports a programmable firmware chip that you can update using the provided utility described in section “4.1 Managing and updating your BIOS.”

Use the BIOS Setup program when you are installing a motherboard, reconfiguring your system, or prompted to “Run Setup”. This section explains how to configure your system using this utility.

Even if you are not prompted to use the Setup program, you can change the configuration of your computer in the future. For example, you can enable the security password feature or change the power management settings. This requires you to reconfigure your system using the BIOS Setup program so that the computer can recognize these changes and record them in the CMOS RAM of the firmware hub.

The firmware hub on the motherboard stores the Setup utility. When you start up the computer, the system provides you with the opportunity to run this program. Press during the Power-On-Self-Test (POST) to enter the Setup utility; otherwise, POST continues with its test routines.

If you wish to enter Setup after POST, restart the system by pressing <Ctrl+Alt+Delete>, or by pressing the reset button on the system chassis. You can also restart by turning the system off and then back on. Do this last option only if the first two failed.

The Setup program is designed to make it as easy to use as possible. Being a menu-driven program, it lets you scroll through the various sub-menus and make your selections from the available options using the navigation keys.



-
- The default BIOS settings for this motherboard apply for most conditions to ensure optimum performance. If the system becomes unstable after changing any BIOS settings, load the default settings to ensure system compatibility and stability. Select the **Load Default Settings** item under the Exit Menu. See section “4.7 Exit Menu.”
 - The BIOS setup screens shown in this section are for reference purposes only, and may not exactly match what you see on your screen.
 - Visit the ASUS website (www.asus.com) to download the latest BIOS file for this motherboard and .
-

4.2.1 BIOS menu screen

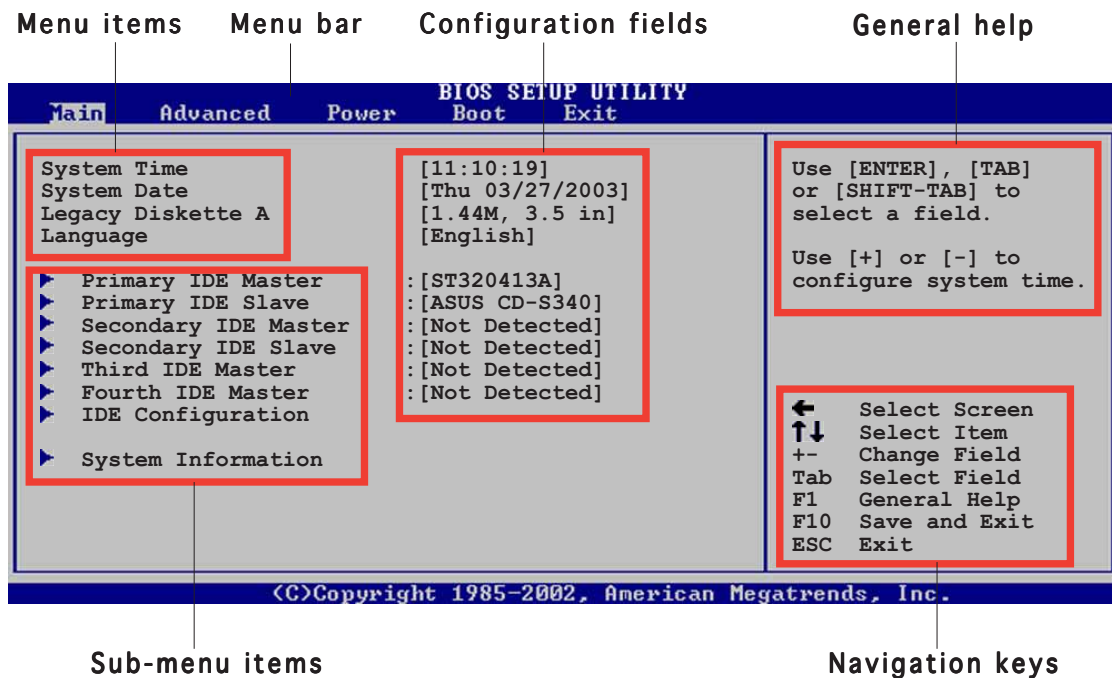

4.2.2 Menu bar

The menu bar on top of the screen has the following main items:

- Main** For changing the basic system configuration
- Advanced** For changing the advanced system settings
- Power** For changing the advanced power management (APM) configuration
- Boot** For changing the system boot configuration
- Exit** For selecting the exit options and loading default settings

To select an item on the menu bar, press the right or left arrow key on the keyboard until the desired item is highlighted.

4.2.3 Navigation keys

At the bottom right corner of a menu screen are the navigation keys for that particular menu. Use the navigation keys to select items in the menu and change the settings.



Some of the navigation keys differ from one screen to another.

4.2.4 Menu items

The highlighted item on the menu bar displays the specific items for that menu. For example, selecting **Main** shows the Main menu items.

The other items (Advanced, Power, Boot, and Exit) on the menu bar have their respective menu items.

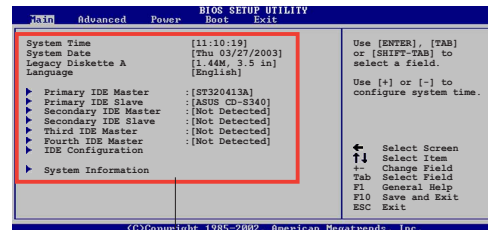

Main menu items

4.2.5 Sub-menu items

A solid triangle before each item on any menu screen means that the item has a sub-menu. To display the sub-menu, select the item and press <Enter>.

4.2.6 Configuration fields

These fields show the values for the menu items. If an item is user-configurable, you can change the value of the field opposite the item. You cannot select an item that is not user-configurable.

A configurable field is enclosed in brackets, and is highlighted when selected. To change the value of a field, select it then press <Enter> to display a list of options. Refer to “4.2.7 Pop-up window.”

4.2.7 Pop-up window

Select a menu item then press <Enter> to display a pop-up window with the configuration options for that item.

4.2.8 Scroll bar

A scroll bar appears on the right side of a menu screen when there are items that do not fit on the screen. Press the Up/Down arrow keys or <Page Up> / <Page Down> keys to display the other items on the screen.

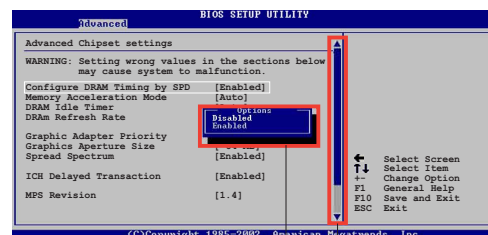

Pop-up window

Scroll bar

4.2.9 General help

At the top right corner of the menu screen is a brief description of the selected item.

4.3 Main menu

When you enter the BIOS Setup program, the Main menu screen appears, giving you an overview of the basic system information.



Refer to section “4.2.1 BIOS menu screen” for information on the menu screen items and how to navigate through them.

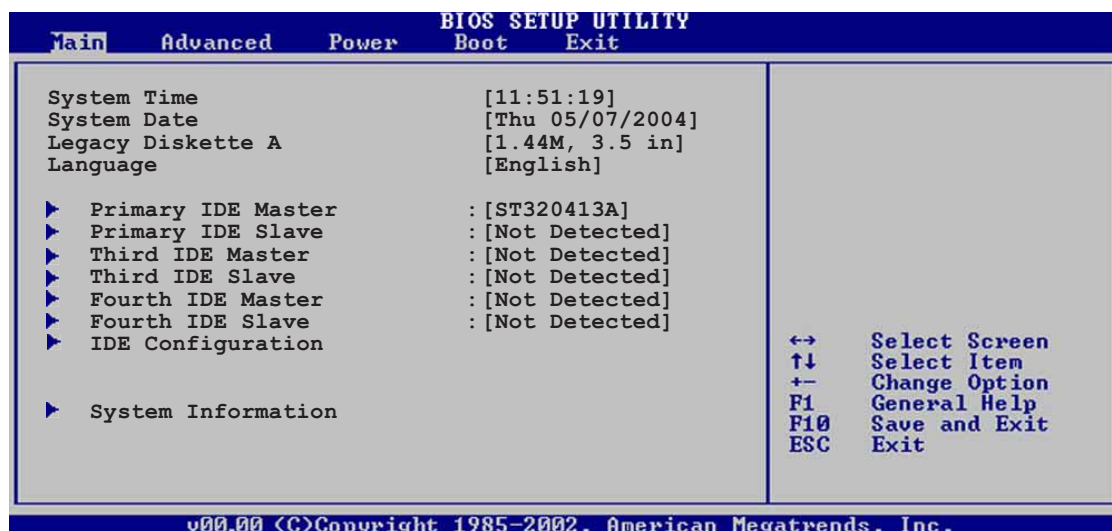

4.3.1 System Time [xx:xx:xxxx]

Allows you to set the system time.

4.3.2 System Date [Day xx/xx/xxxx]

Allows you to set the system date.

4.3.3 Legacy Diskette A [1.44M, 3.5 in.]

Sets the type of floppy drive installed. Configuration options: [Disabled] [360K, 5.25 in.] [1.2M , 5.25 in.] [720K , 3.5 in.] [1.44M, 3.5 in.] [2.88M, 3.5 in.]

4.3.4 Language [English]

Allows you to choose the BIOS language version from the options. Configuration options: [Français] [German] [English]

4.3.5 Primary, Third and Fourth IDE Master/Slave

While entering Setup, the BIOS automatically detects the presence of IDE devices. There is a separate sub-menu for each IDE device. Select a device item then press <Enter> to display the IDE device information.

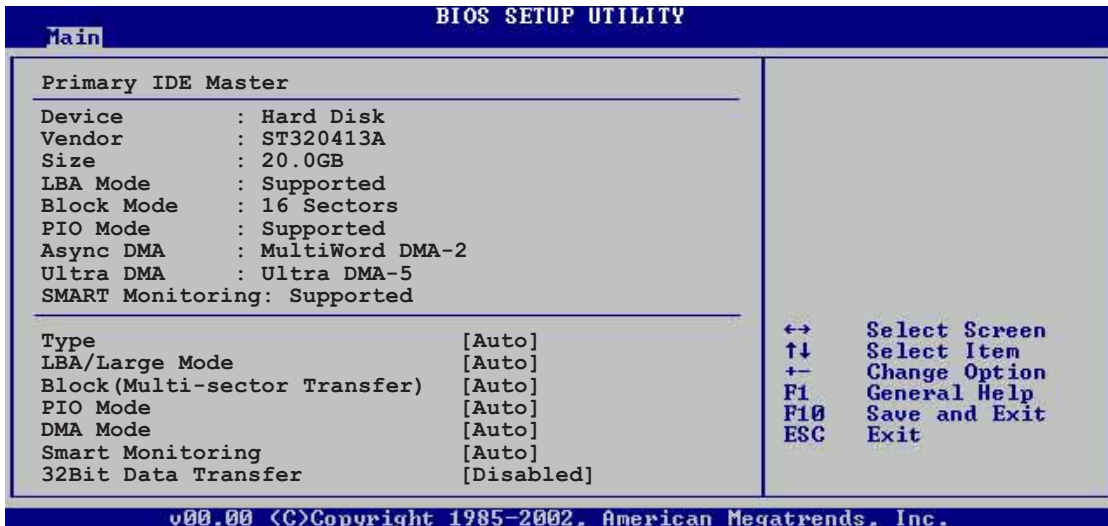

The BIOS automatically detects the values opposite the dimmed items (Device, Vendor, Size, LBA Mode, Block Mode, PIO Mode, Async DMA, Ultra DMA, and SMART monitoring). These values are not user-configurable. These items show N/A if no IDE device is installed in the system.

Type [Auto]

Selects the type of IDE drive. Setting to Auto allows automatic selection of the appropriate IDE device type. Select CDROM if you are specifically configuring a CD-ROM drive. Select ARMD (ATAPI Removable Media Device) if your device is either a ZIP, LS-120, or MO drive. Configuration options: [Not Installed] [Auto] [CDROM] [ARMD]

LBA/Large Mode [Auto]

Enables or disables the LBA mode. Setting to Auto enables the LBA mode if the device supports this mode, and if the device was not previously formatted with LBA mode disabled. Configuration options: [Disabled] [Auto]

Block (Multi-sector Transfer) [Auto]

Enables or disables data multi-sectors transfers. When set to Auto, the data transfer from and to the device occurs multiple sectors at a time if the device supports multi-sector transfer feature. When set to [Disabled], the data transfer from and to the device occurs one sector at a time. Configuration options: [Disabled] [Auto]

PIO Mode [Auto]

Selects the PIO mode.

Configuration options: [Auto] [0] [1] [2] [3] [4]

DMA Mode [Auto]

Selects the DMA mode. Configuration options: [Auto] [SWDMA0]

[SWDMA1] [SWDMA2] [MWDMA0] [MWDMA1] [MWDMA2] [UDMA0]

[UDMA1] [UDMA2] [UDMA3] [UDMA4] [UDMA5]

SMART Monitoring [Auto]

Sets the Smart Monitoring, Analysis, and Reporting Technology.

Configuration options: [Auto] [Disabled] [Enabled]

32Bit Data Transfer [Disabled]

Enables or disables 32-bit data transfer.

Configuration options: [Disabled] [Enabled]

4.3.6 IDE Configuration

The items in this menu allow you to set or change the configurations for the IDE devices installed in the system. Select an item then press <Enter> if you wish to configure the item.

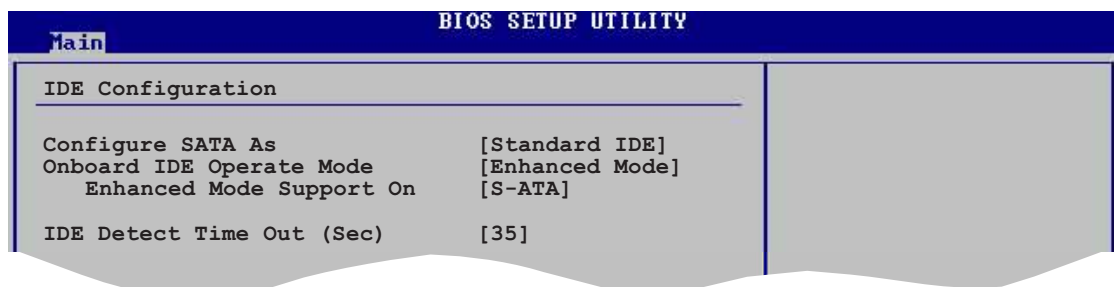

Configure SATA As [Standard IDE]

Sets the Serial ATA configuration. When set in Advanced Host Controller Interface (AHCI) or RAID mode the SATA controller is set to Native mode.

Configuration options: [Standard IDE] [AHCI] [RAID]

Onboard IDE Operate Mode [Enhanced Mode]

Allows selection of the IDE operation mode depending on the operating system (OS) that you installed. Set to Enhanced Mode if you are using native OS, such as Windows® 2000/XP.

Configuration options: [Compatible Mode] [Enhanced Mode]

Enhanced Mode Support On [S-ATA]

The default setting S-ATA allows you to use native OS on Serial ATA and Parallel ATA ports. We recommend that you do not change the default setting for better OS compatibility. In this setting, you may use legacy OS on the Parallel ATA ports **only if** you did not install any Serial ATA device.

The P-ATA+S-ATA and P-ATA options are for advanced users only. If you set to any of these options and encounter problems, revert to the default setting **S-ATA**. Configuration options: [P-ATA+S-ATA] [S-ATA] [P-ATA]



The **Onboard IDE Operate Mode** and its submenu items appear only when the **Configure SATA As** item is set to Standard IDE.

Onboard Serial-ATA BOOTROOM [Enabled]

Enables or disables the onboard Serial ATA boot ROM. This item appears only when the Configure SATA As item is set as RAID. Configuration options: [Disabled] [Enabled]



The **Onboard Serial-ATA BOOTROM** item appears only when the **Configure SATA As** item is set to RAID.

ALPE and ASP [Disabled]

Enables or disables the ALPE and ASP. This item appears only when the Configure SATA As item is set as AHCI. Configuration options: [Disabled] [Enabled]

Stagger Spinup Support [Enabled]

Enables or disables the stagger spinup support. Configuration options: [Disabled] [Enabled]

AHCI Port 3 Interlock Switch [Disabled]

Enables or disables the Advanced Host Controller Interface (AHCI) Port 3 interlock switch. Configuration options: [Disabled] [Enabled]



The **ALPE and ASP** item appears only when the **Configure SATA As** item is set to AHCI or RAID.

IDE Detect Time Out [35]

Selects the time out value for detecting ATA/ATAPI devices. Configuration options: [0] [5] [10] [15] [20] [25] [30] [35]

4.3.7 System Information

This menu gives you an overview of the general system specifications. The BIOS automatically detects the items in this menu.

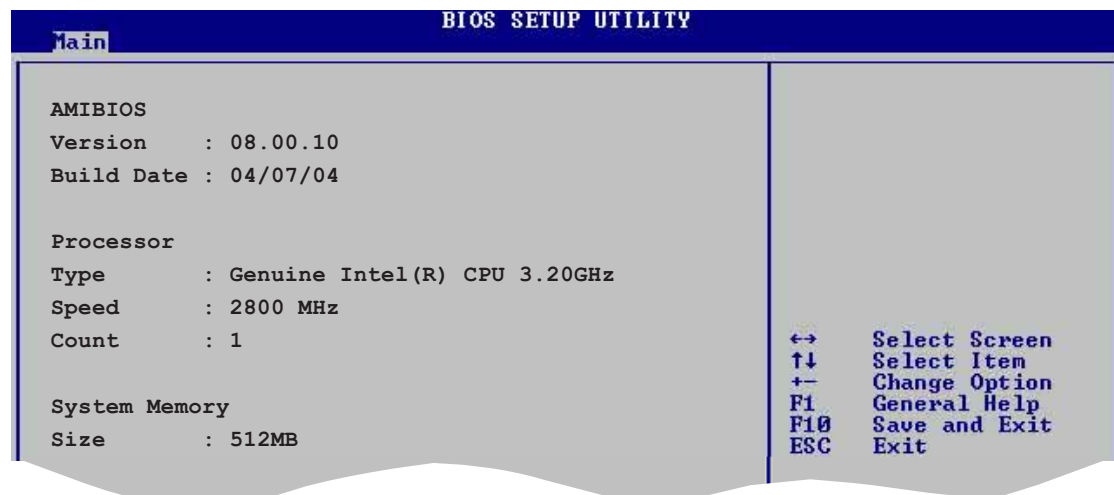

AMI BIOS

Displays the auto-detected BIOS information

Processor

Displays the auto-detected CPU specification

System Memory

Displays the auto-detected system memory

4.4 Advanced menu

The Advanced menu items allow you to change the settings for the CPU and other system devices.



Take caution when changing the settings of the Advanced menu items. Incorrect field values can cause the system to malfunction.

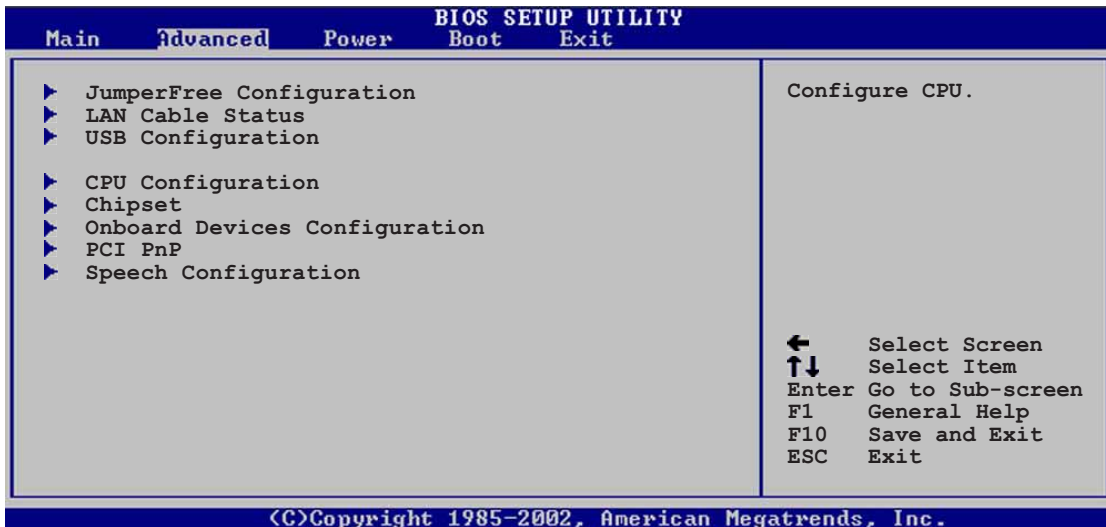

4.4.1 JumperFree Configuration

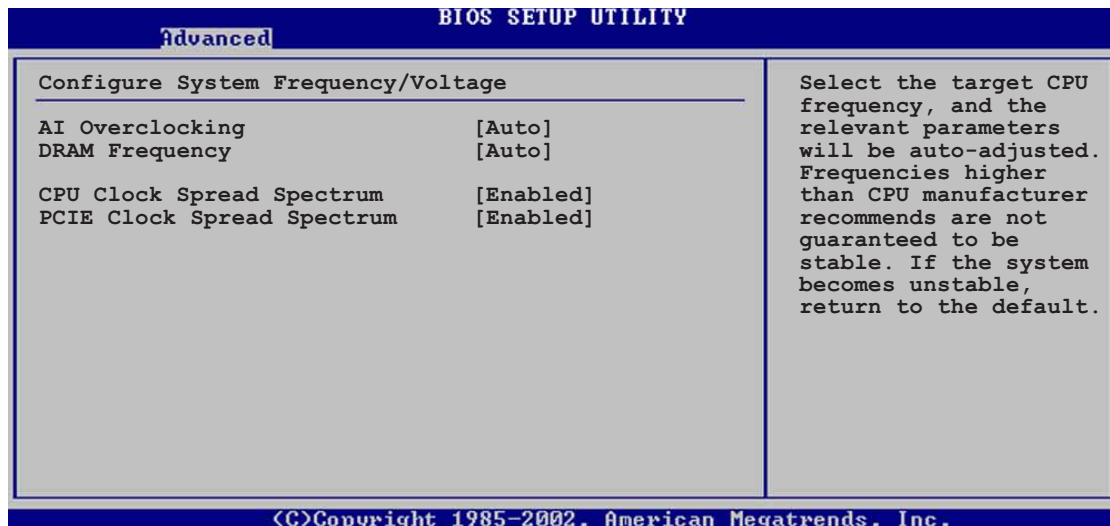

AI Overclocking [Auto]

Allows selection of CPU overclocking options to achieve desired CPU internal frequency. Select either one of the preset overclocking options. Configuration options: [Manual] [Auto] [Standard] [Overclock Profile] [AI N.O.S]



Selecting a very high CPU frequency may cause the system to become unstable! If this happens, revert to the default setting.

DRAM Frequency [Auto]

Allows you to set the DDR operating frequency.

Configuration options: [Auto] [400 MHz] [533 MHz] [600 MHz]



Selecting a DRAM frequency that is not supported by your DIMM module may cause the system to become unstable! If this happens, revert to the default setting.

CPU Clock Spread Spectrum [Enabled]

Enables or disabled the CPU clock spread spectrum.

Configuration options: [Disabled] [Enabled]

PCIe Clock Spread Spectrum [Enabled]

Enables or disabled the PCI Express clock spread spectrum.

Configuration options: [Disabled] [Enabled]



The following item appears only when the AI Overclocking item is set to [Standard].

Memory Voltage [Auto]

Allows selection of the DDR SDRAM operating voltage. Set to Auto for safe mode. Configuration options: [1.80V] [1.90V] [2.00V] [2.10V] [Auto]

Chipset Core Voltage [Auto]

Allows selection of the chipset core voltage.

Configuration options: [1.50V] [1.60V] [Auto]

CPU VCore Voltage [Auto]

Allows selection of the CPU VCore voltage.

Configuration options: [Auto] [1.7000V] [1.6875V] [1.6750] 1.6625V] [1.6500V] [1.6375V] [1.6250V] [1.6125V] [1.6000V] [1.5875V] [1.5750V] [1.5625V] [1.5500V] [1.5375V] [1.5250V] [1.5125V] [1.5000V] [1.4875V] [1.4750V] [1.4625V] [1.4500V] [1.4375V] [1.4250V] [1.4125V] [1.4000V]



Selecting a very high VCore voltage may cause the system to become unstable! If this happens, revert to the default setting.

CPU VCore Over Voltage Control [Disabled]

Enables or disables the CPU VCore over voltage control.

Configuration options: [Disabled] [Enabled]

FSB Termination Voltage [Auto]

Sets the Front Side Bus (FSB) termination voltage.
Configuration options: [1.20V] [1.40V] [Auto]



The following item appears only when the AI Overclocking item is set to [Manual].

CPU to NB Trapping [Auto]

Sets the CPU to the NorthBridge trapping frequency.
Configuration options: [Auto] [000(100/266MHz)] [001(133MHz)] [010(200MHz)] [011(166MHz)]

CPU Frequency [XXX] (value is auto-detected)

Indicates the frequency sent by the clock generator to the system bus and PCI bus. The bus frequency (external frequency) multiplied by the bus multiple equals the CPU speed. The value of this item is auto-detected by BIOS. The values range from 100 to 400. Refer to the following table for the correct Front Side Bus and CPU External Frequency settings. Use the <+> and <-> keys to adjust the value.

Table 4.4.2 FSB/CPU External Frequency Synchronization

Front Side Bus	CPU External Frequency
FSB 800	200 MHz
FSB 533	133 MHz
FSB 400	100 MHz



Selecting a very high CPU frequency may cause the system to become unstable! If this happens, revert to the default setting.

PCI Express Frequency [100]

Sets the PCI Express frequency. Configuration options: [90] [91] ~ [120]

SATA Clock Sync to PCIEX [Disabled]

Enables or disables the SATA clock synchronization to the PCI Express.
Configuration options: [Disabled] [Enabled]

PCI Clock Synchronization Mode [Asynchronization]

Selects the PCI Clock Synchronization mode.
Configuration options: [To CPU] [To PCI Express] [Asynchronization]



The following item appears only when the AI Overclocking item is set to [Overclock Profile].

Overclock Options [Overclock 5%]

Allows you to set the overlocking options.

Configuration options: [Overclock 5%] [Overclock 10%] [Overclock 20%]
[Overclock 30%]



The following item appears only when the AI Overclocking item is set to [AI N.O.S.].

NOS Mode [Auto]

The ASUS Non-delay Overclocking System (NOS) mode dynamically overlocks the CPU speed depending on the CPU loading. This option allows you to set the NOS mode for various CPU loading. Selecting [Auto] allows the NOS to automatically overclock the CPU speed based on the CPU loading. Configuration options: [Auto] [Standard] [Sensitive] [Heavy Load]



The following item appears only when the N.O.S Mode item is not set to [Auto].

Turbo NOS [Disabled]

Disables or sets the overclock percentage for the selected NOS mode. Configuration options: [Disabled] [Overclock 3%] [Overclock 5%] [Overclock 7%] [Overclock 10%] [Overclock 15%] [Overclock 20%] [Overclock 30%]



Refer to the CPU documentation before setting the CPU VCore voltage. A very high Vcore voltage can severely damage the CPU!

4.4.2 LAN Cable Status

The ASUS AI NET2 feature diagnoses and reports the status of the Ethernet cables connected to the LAN (RJ-45) port on the rear panel.

Advanced			BIOS SETUP UTILITY
POST Check LAN cable		[Disabled]	
LAN Cable Status			
Pair	Status	Length	
1-2	Open	0.0M	
3-6	Open	0.0M	
4-5	Open	0.0M	
7-8	Open	0.0M	

POST Check LAN cable [Disabled]

Enables or disables checking of the LAN cable during POST.
Configuration options: [Disabled] [Enabled]

4.4.3 USB Configuration

The items in this menu allows you to change the USB-related features. Select an item then press <Enter> to display the configuration options.

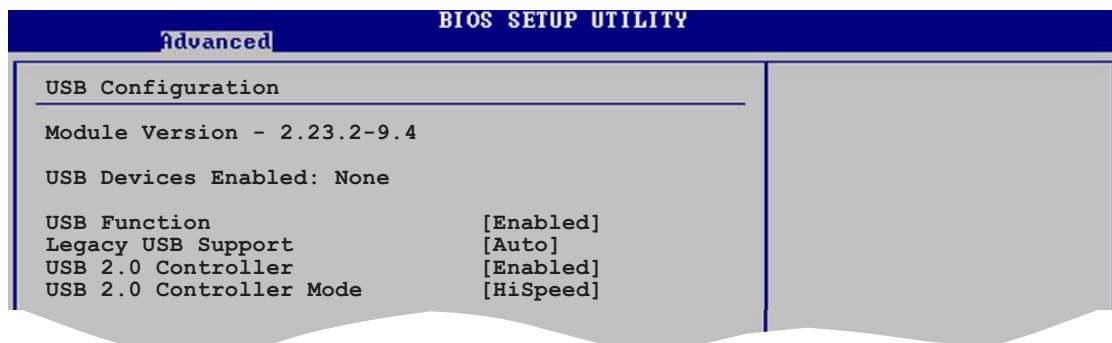

The Module Version and USB Devices Enabled items show the auto-detected values. If no USB device is detected, the item shows None.

USB Function [Enabled]

Allows you to enable or disable the USB function.
Configuration options: [Disabled] [Enabled]

Legacy USB Support [Auto]

Allows you to enable or disable support for USB devices on legacy operating systems (OS). Setting to Auto allows the system to detect the presence of USB devices at startup. If detected, the USB controller legacy mode is enabled. If no USB device is detected, the legacy USB support is disabled.

Configuration options: [Disabled] [Enabled] [Auto]

USB 2.0 Controller [Enabled]

Allows you to enable or disable the USB 2.0 controller.
Configuration options: [Disabled] [Enabled]

USB 2.0 Controller Mode [HiSpeed]

Allows you to configure the USB 2.0 controller in HiSpeed (480 Mbps) or Full Speed (12 Mbps). Configuration options: [HiSpeed] [Full Speed]

4.4.4 CPU Configuration

The items in this menu show the CPU-related information that the BIOS automatically detects.

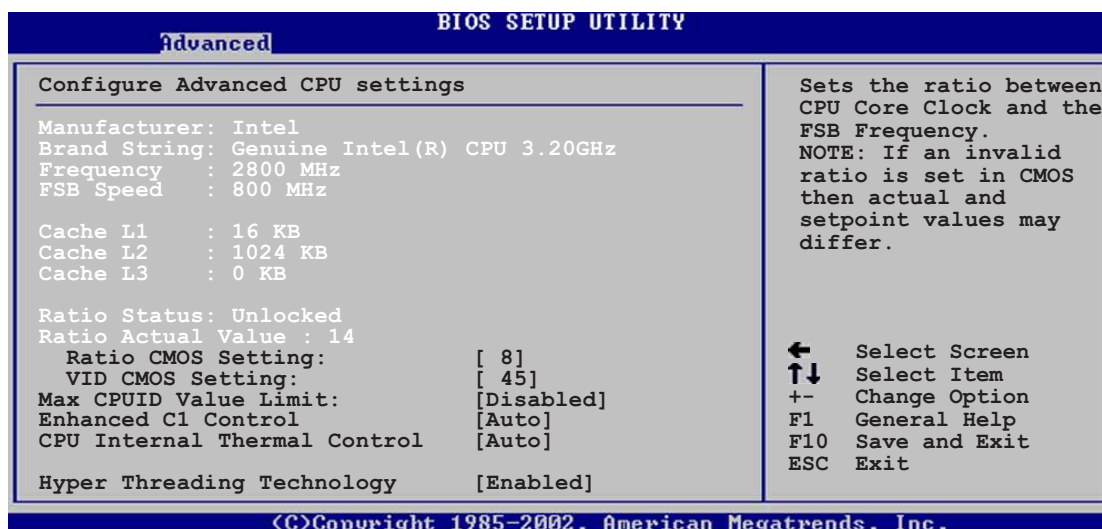

Ratio CMOS Setting [8]

Sets the ratio between the CPU Core Clock and the Front Side Bus frequency. The default value of this item is auto-detected by the BIOS. Use the <+> or <-> keys to adjust the values.

VID CMOS Setting [45]

Allows you to set the VID CMOS setting at which the processor is to run. The default value of this item is auto-detected by the BIOS. Use the <+> or <-> keys to adjust the values.



You can only set the values of the **Ratio CMOS Setting** and **VID CMOS Setting** items if you installed an unlocked CPU, otherwise, it will only display default values based on the CPU installed.

Max CPUID Value Limit [Disabled]

Enable this item to boot legacy operating systems that cannot support CPUs with extended CPUID functions.

Configuration options: [Disabled] [Enabled]

Enhanced C1 Control [Auto]

When set to [Auto], the BIOS will automatically check the CPU's capability to enable the C1E support. In C1E mode, the CPU power consumption is lower when idle. Configuration options: [Auto] [Disabled]

CPU Internal Thermal Control [Auto]

Disables or sets the CPU internal thermal control.

Configuration options: [Disabled] [Auto]

Hyper-Threading Technology [Enabled]

Allows you to enable or disable the processor Hyper-Threading Technology.
Configuration options: [Disabled] [Enabled]

4.4.5 Chipset

The Chipset menu allows you to change the advanced chipset settings.
Select an item then press <Enter> to display the sub-menu.

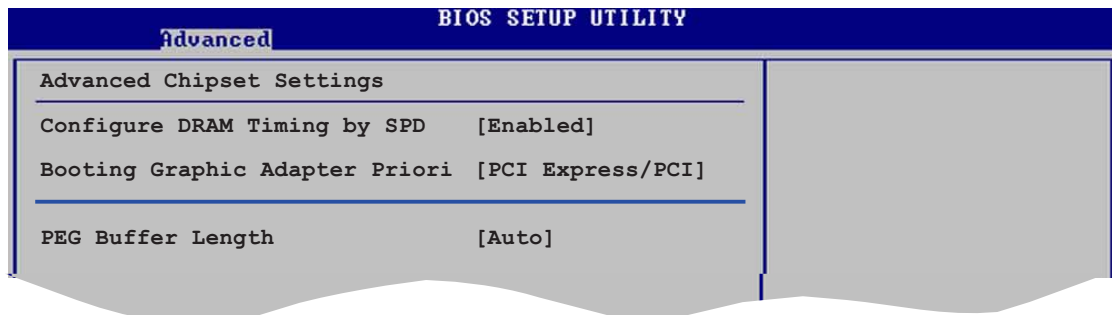

Advanced Chipset Settings

Configure DRAM Timing by SPD [Enabled]

When this item is enabled, the DRAM timing parameters are set according to the DRAM SPD (Serial Presence Detect). When disabled, you can manually set the DRAM timing parameters through the DRAM sub-items. The following sub-items appear when this item is Disabled.
Configuration options: [Disabled] [Enabled]

DRAM CAS# Latency [5 Clocks]

Controls the latency between the SDRAM read command and the time the data actually becomes available.
Configuration options: [5 Clocks] [4 Clocks]

DRAM RAS# Precharge [4 Clocks]

Controls the idle clocks after issuing a precharge command to the DDR SDRAM. Configuration options: [2 Clocks] [3 Clocks] [4 Clocks] [5 Clocks]

DRAM RAS# to CAS# Delay [4 Clocks]

Controls the latency between the DDR SDRAM active command and the read/write command. Configuration options: [2 Clocks] [3 Clocks] [4 Clocks] [5 Clocks]

DRAM RAS# Activate to Precharge Delay [15 Clocks]

Configuration options: [4 Clocks] [5 Clocks] ~ [15 Clocks]

DRAM Burst Length [8]

Sets the DRAM Burst Length. Configuration options: [4] [8]

Booting Graphic Adapter Priority [PCI Express/PCI]

Allows selection of the graphics controller to use as primary boot device.

Configuration options: [Internal VGA] [PCI Express/Int-VGA]

[PCI Express/PCI] [PCI/PCI Express] [PCI/Int-VGA]

PEG Buffer Length [Auto]

Sets the PCI Express Graphics card buffer length.

Configuration options: [Auto] [Long] [Short]

4.4.6 Onboard Devices Configuration

Advanced		BIOS SETUP UTILITY	
Configure Win627EHF Super IO Chipset			
Azalia Controller	[Enabled]		
Front Panel Support Type	[AC'97]		
Onboard 1394 Controller	[Enabled]		
Onboard PCIEX GbE LAN	[Enabled]		
LAN Option ROM	[Disabled]		
Onboard WIFI Controller	[Enabled]		
ITE8212F Controller	[IDE Mode]		
Detecting Device Time	[Quick Mode]		
Silicon Image Controller	[Enabled]		
Serial Port1 Address	[3F8/IRQ4]		
Serial Port2 Address	[2F8/IRQ3]		
Parallel Port Address	[378]		
Parallel Port Mode	[ECP]		
ECP Mode DMA Channel	[DMA3]		
Parallel Port IRQ	[IRQ7]		
Onboard Game/MIDI Port	[Disabled]		

(C)Copyright 1985-2002, American Megatrends, Inc.

Azalia Controller [Enabled]

Enables or disables the Azalia/AC'97 CODEC.
Configuration options: [Enabled] [Disabled]

Front Panel Support Type [AC'97]

Sets the front panel support type. Set this item to Azalia to enable High-Definition audio features on the front panel audio connector.
Configuration options: [AC'97] [Azalia]

Onboard 1394 Controller [Enabled]

Enables or disables the onboard 1394 controller.
Configuration options: [Enabled] [Disabled]

OnBoard PCIEX GbE LAN [Enabled]

Allows you to enable or disable the onboard PCI Express Gigabit LAN controller. Configuration options: [Disabled] [Enabled]

LAN Option ROM [Disabled]

Allows you to enable or disable the option ROM in the onboard LAN controller. This item appears only when the Onboard LAN item is set to Enabled. Configuration options: [Disabled] [Enabled]

OnBoard WIFI Controller [Enabled]

Allows you to enable or disable the onboard Wi-Fi controller.
Configuration options: [Disabled] [Enabled]

ITE8212F Controller [IDE Mode]

Allows you to set the onboard ITE® 8212F RAID controller operating mode.
Configuration options: [RAID Mode] [IDE Mode] [Disabled]

Detecting Device Time [Quick Mode]

Sets the ITE8212F detecting device time. If the devices installed on the IDE RAID connectors cannot be detected, set this item to Standard Mode to enable complete detecting process. This item appears only when the ITE8212F Controller is set to IDE Mode.
Configuration options: [Standard Mode] [Quick Mode]

Silicon Image Controller [Enabled]

Allows you to enable or disable the onboard Silicon Image RAID controller.
Configuration options: [Disabled] [Enabled]

Serial Port1 Address [3F8/IRQ4]

Allows you to select the Serial Port1 base address.
Configuration options: [Disabled] [3F8/IRQ4] [3E8/IRQ4] [2E8/IRQ3]

Serial Port2 Address [2F8/IRQ3]

Allows you to select the Serial Port2 base address.
Configuration options: [Disabled] [2F8/IRQ3] [3E8/IRQ4] [2E8/IRQ3]

Parallel Port Address [378]

Allows you to select the Parallel Port base addresses.
Configuration options: [Disabled] [378] [278] [3BC]

Parallel Port Mode [ECP]

Allows you to select the Parallel Port mode.
Configuration options: [Normal] [Bi-directional] [EPP] [ECP]

ECP Mode DMA Channel [DMA3]

Appears only when the Parallel Port Mode is set to [ECP]. This item allows you to set the Parallel Port ECP DMA.
Configuration options: [DMA0] [DMA1] [DMA3]

EPP Version [1.9]

Allows selection of the Parallel Port EPP version. This item appears only when the **Parallel Port Mode** is set to **EPP**.
Configuration options: [1.9] [1.7]

Parallel Port IRQ [IRQ7]

Configuration options: [IRQ5] [IRQ7]

Onboard Game/MIDI Port [Disabled]

Allows you to select the Game Port address or to disable the port.
Configuration options: [Disabled] [200/300] [200/330] [208/300]
[208/330]

4.4.7 PCI PnP

The PCI PnP menu items allow you to change the advanced settings for PCI/PnP devices. The menu includes setting IRQ and DMA channel resources for either PCI/PnP or legacy ISA devices, and setting the memory size block for legacy ISA devices.



Take caution when changing the settings of the PCI PnP menu items. Incorrect field values can cause the system to malfunction.

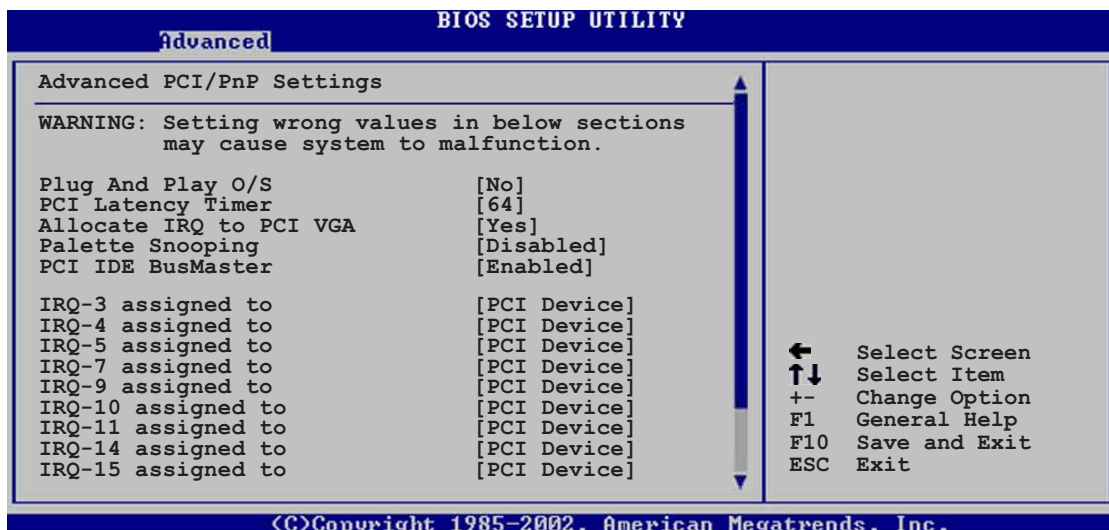

Plug And Play O/S [No]

When set to [No], BIOS configures all the devices in the system. When set to [Yes] and if you install a Plug and Play operating system, the operating system configures the Plug and Play devices not required for boot.
Configuration options: [No] [Yes]

PCI Latency Timer [64]

Allows you to select the value in units of PCI clocks for the PCI device latency timer register. Configuration options: [32] [64] [96] [128] [160] [192] [224] [248]

Allocate IRQ to PCI VGA [Yes]

When set to [Yes], BIOS assigns an IRQ to PCI VGA card if the card requests for an IRQ. When set to [No], BIOS does not assign an IRQ to the PCI VGA card even if requested. Configuration options: [No] [Yes]

Palette Snooping [Disabled]

When set to [Enabled], the palette snooping feature informs the PCI devices installed in the system so that the latter can function correctly. Configuration options: [Disabled] [Enabled]

PCI IDE BusMaster [Enabled]

Allows BIOS to use PCI bus mastering when reading/writing to IDE devices. Configuration options: [Disabled] [Enabled]

IRQ-xx assigned to [PCI Device]

When set to [PCI Device], the specific IRQ is free for use of PCI/PnP devices. When set to [Reserved], the IRQ is reserved for legacy ISA devices. Configuration options: [PCI Device] [Reserved]

4.4.8 Speech Configuration

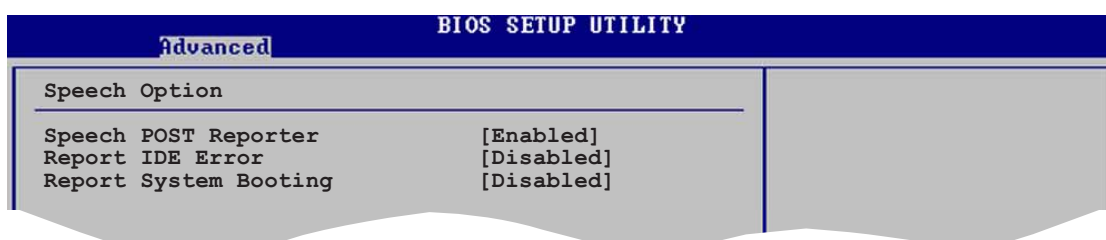

The screenshot shows the BIOS Setup Utility interface. At the top, it says "BIOS SETUP UTILITY" and "Advanced". Below that, there is a section titled "Speech Option" with a horizontal line above it. The options listed are:

Speech Option	Value
Speech POST Reporter	[Enabled]
Report IDE Error	[Disabled]
Report System Booting	[Disabled]

Speech POST Reporter [Enabled]

Allows you to enable or disable the ASUS Speech POST Reporter™ feature. Configuration options: [Disabled] [Enabled]



The following items appear only when Speech POST Reporter is set to Enabled.

Report IDE Error [Disabled]

Enables or disables the report feature in the event of an IDE error. Configuration options: [Disabled] [Enabled]

Report System Booting [Disabled]

Enables or disables the report after booting the system. Configuration options: [Disabled] [Enabled]

4.5 Power menu

The Power menu items allow you to change the settings for the Advanced Power Management (APM). Select an item then press <Enter> to display the configuration options.

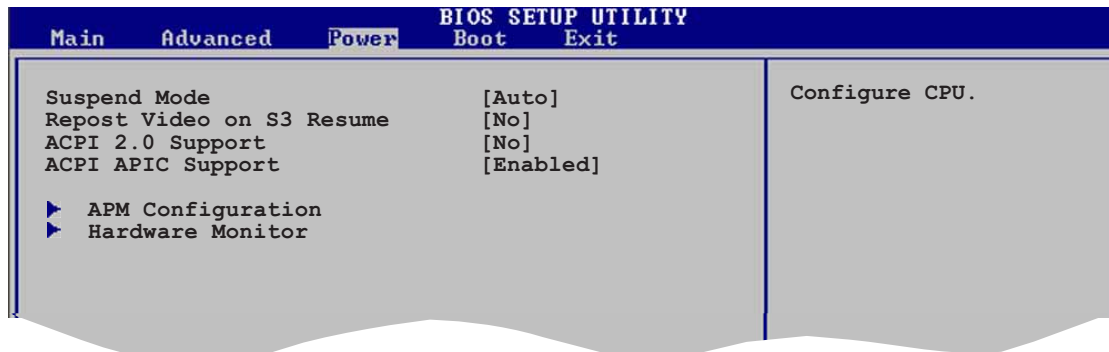

4.5.1 Suspend Mode [Auto]

Allows you to select the Advanced Configuration and Power Interface (ACPI) state to be used for system suspend.

Configuration options: [S1 (POS) Only] [S3 Only] [Auto]

4.5.2 Repost Video on S3 Resume [No]

Determines whether to invoke VGA BIOS POST on S3/STR resume.

Configuration options: [No] [Yes]

4.5.3 ACPI 2.0 Support [No]

Allows you to add more tables for Advanced Configuration and Power Interface (ACPI) 2.0 specifications. Configuration options: [No] [Yes]

4.5.4 ACPI APIC Support [Enabled]

Allows you to enable or disable the Advanced Configuration and Power Interface (ACPI) support in the Application-Specific Integrated Circuit (ASIC). When set to Enabled, the ACPI APIC table pointer is included in the RSDT pointer list. Configuration options: [Disabled] [Enabled]

4.5.5 APM Configuration

BIOS SETUP UTILITY	
Power	
APM Configuration	
Power Button Mode	[On/Off]
Restore on AC Power Loss	[Power Off]
Power On By RTC Alarm	[Disabled]
Power On By External Modems	[Disabled]
Power On By PCI Devices	[Disabled]
Power On By PS/2 Keyboard	[Disabled]
Keyboard Wakeup Password : Not Installed	
Power On By PS/2 Mouse	[Disabled]

Power Button Mode [On/Off]

Allows the system to go into On/Off mode or suspend mode when the power button is pressed. Configuration options: [On/Off] [Suspend]

Restore on AC Power Loss [Power Off]

When set to Power Off, the system goes into off state after an AC power loss. When set to Power On, the system goes on after an AC power loss. When set to Last State, the system goes into either off or on state, whatever the system state was before the AC power loss. Configuration options: [Power Off] [Power On] [Last State]

Power On By RTC Alarm [Disabled]

Allows you to enable or disable RTC to generate a wake event. When this item is set to Enabled, the items RTC Alarm Date, RTC Alarm Hour, RTC Alarm Minute, and RTC Alarm Second appear with set values. Configuration options: [Disabled] [Enabled]

Power On By External Modems [Disabled]

This allows either settings of [Enabled] or [Disabled] for powering up the computer when the external modem receives a call while the computer is in Soft-off mode. Configuration options: [Disabled] [Enabled]



The computer cannot receive or transmit data until the computer and applications are fully running. Thus, connection cannot be made on the first try. Turning an external modem off and then back on while the computer is off causes an initialization string that turns the system power on.

Power On By PCI Devices [Disabled]

When set to [Enabled], this parameter allows you to turn on the system through a PCI LAN or modem card. This feature requires an ATX power supply that provides at least 1A on the +5VSB lead.

Configuration options: [Disabled] [Enabled]

Power On By PS/2 Keyboard [Disabled]

Allows you to use specific keys on the keyboard to turn on the system. This feature requires an ATX power supply that provides at least 1A on the +5VSB lead. Configuration options: [Disabled] [Enabled]

Wakeup Password

This item appears only when the Power On By PS/2 Keyboard is set to Enabled. Select this item to set or change the keyboard wakeup password. The **Keyboard Wakeup Password** item that appears below shows the default **Not Installed**. After you have set a password, this item shows **Installed**.

Power On By PS/2 Mouse [Disabled]

When set to [Enabled], this parameter allows you to use the PS/2 mouse to turn on the system. This feature requires an ATX power supply that provides at least 1A on the +5VSB lead.

Configuration options: [Disabled] [Enabled]

4.5.6 Hardware Monitor

BIOS SETUP UTILITY	
Power	
Hardware Monitor	
CPU Temperature	[51°C/122.5°F]
MB Temperature	[41°C/105.5°F]
CPU Fan Speed	[3813 RPM]
CPU Q-Fan Control	[Disabled]
Chassis Fan Speed	[N/A]
Chassis Q-Fan Control	[Disabled]
Power Fan Speed	[N/A]
VCORE Voltage	[1.320V]
3.3V Voltage	[3.345V]
5V Voltage	[5.094V]
12V Voltage	[11.880V]
←	Select Screen
↑↓	Select Item
+ -	Change Option
F1	General Help
F10	Save and Exit
ESC	Exit

©Copyright 1985-2002, American Megatrends, Inc.

CPU Temperature [xxx°C/xxx°F]

MB Temperature [xxx°C/xxx°F]

The onboard hardware monitor automatically detects and displays the motherboard and CPU temperatures. Select Disabled if you do not wish to display the detected temperatures.

CPU Fan Speed [xxxxRPM] or [N/A]

The onboard hardware monitor automatically detects and displays the CPU fan speed in rotations per minute (RPM). If the fan is not connected to the motherboard, the field shows N/A.

CPU Q-Fan Control [Disabled]

Allows you to enable or disable the ASUS Q-Fan feature that smartly adjusts the fan speeds for more efficient system operation. When this field is set to [Enabled], the **CPU Fan Ratio** item appears to allow selection of the appropriate fan speed ratio. Configuration options: [Disabled] [Enabled]

CPU Fan Ratio [Auto]

Allows you to select the appropriate CPU fan speed ratio for the system. The default [Auto] automatically selects the fan speed ratio when operating a low CPU temperature. Select a higher ratio if you installed additional devices and the system requires more ventilation. This item appears only when the CPU Q-Fan Control item is Enabled. Configuration options: [Auto] [75%] [70%] [65%] [60%]



For optimum performance, use of a 4-pin CPU fan that complies with the Intel® Pulse Width Modulator (PWM) specifications is recommended.

CPU Target Temperature [xxx°C]

Allows you to set the CPU temperature threshold when the CPU fan speed is increased to lower the CPU temperature. This item appears only when the CPU Q-Fan Control item is Enabled. The configuration option varies depending on the CPU installed.

Chassis Fan Speed [xxxxRPM] or [N/A]

The onboard hardware monitor automatically detects and displays the chassis fan speed in rotations per minute (RPM). If the fan is not connected to the chassis, the specific field shows N/A.

Chassis Q-Fan Control [Disabled]

Allows you to enable or disable the ASUS Q-Fan feature that smartly adjusts the fan speeds for more efficient system operation. When this field is set to [Enabled], the **Chassis Fan Ratio** item appears to allow selection of the appropriate fan speed ratio.
Configuration options: [Disabled] [Enabled]

Chassis Fan Ratio [Auto]

Allows you to select the appropriate chassis fan speed ratio for the system. The default [Auto] automatically selects the fan speed ratio when operating a low chassis temperature. Select a higher ratio if you installed additional devices and the system requires more ventilation. This item appears only when the chassis Q-Fan Control item is Enabled.
Configuration options: [Auto] [75%] [70%] [65%] [60%]



Only the CPU fan (CPU_FAN1) and chassis fan 1 (CHA_FAN1) connectors support the ASUS Q-Fan 2 feature.

Power Fan Speed [xxxxRPM] or [N/A]

The onboard hardware monitor automatically detects and displays the power fan speed in rotations per minute (RPM). If the fan is not connected to the power fan connector, the specific field shows N/A.

VCORE Voltage, 3.3V Voltage, 5V Voltage, 12V Voltage

The onboard hardware monitor automatically detects the voltage output through the onboard voltage regulators.

4.6 Boot menu

The Boot menu items allow you to change the system boot options. Select an item then press <Enter> to display the sub-menu.

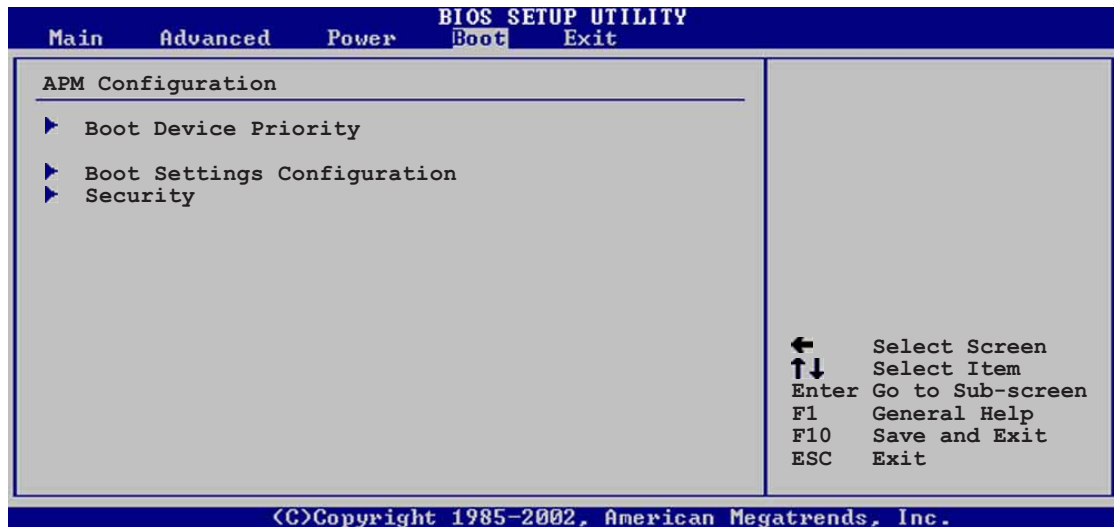

4.6.1 Boot Device Priority

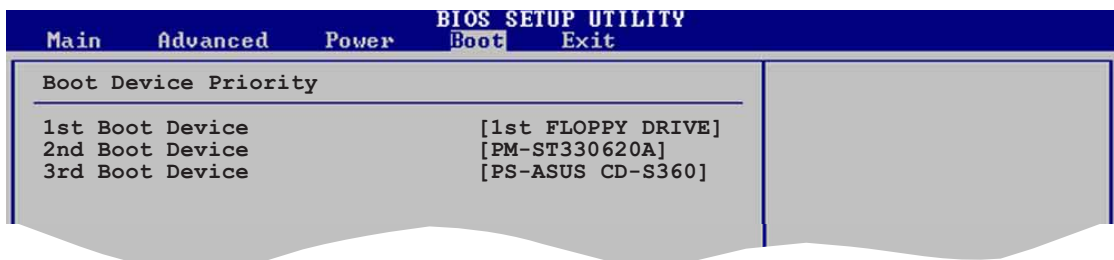

1st ~ xxth Boot Device [1st Floppy Drive]

These items specify the boot device priority sequence from the available devices. The number of device items that appears on the screen depends on the number of devices installed in the system.

Configuration options: [xxxxx Drive] [Disabled]

4.6.2 Boot Settings Configuration

BIOS SETUP UTILITY	
Boot	
Boot Settings Configuration	
Quick Boot	[Enabled]
Full Screen Logo	[Enabled]
AddOn ROM Display Mode	[Force BIOS]
Bootup Num-Lock	[On]
PS/2 Mouse Support	[Auto]
Wait For 'F1' If Error	[Enabled]
Hit 'DEL' Message Display	[Enabled]
Interrupt 19 Capture	[Disabled]

Allows BIOS to skip certain tests while booting. This will decrease the time needed to boot the system.

Quick Boot [Enabled]

Enabling this item allows the BIOS to skip some power on self tests (POST) while booting to decrease the time needed to boot the system. When set to [Disabled], BIOS performs all the POST items.

Configuration options: [Disabled] [Enabled]

Full Screen Logo [Enabled]

This allows you to enable or disable the full screen logo display feature.

Configuration options: [Disabled] [Enabled]



Set this item to [Enabled] to use the ASUS MyLogo2™ feature.

Add On ROM Display Mode [Force BIOS]

Sets the display mode for option ROM.

Configuration options: [Force BIOS] [Keep Current]

Bootup Num-Lock [On]

Allows you to select the power-on state for the NumLock.

Configuration options: [Off] [On]

PS/2 Mouse Support [Auto]

Allows you to enable or disable support for PS/2 mouse.

Configuration options: [Disabled] [Enabled] [Auto]

Wait for 'F1' If Error [Enabled]

When set to Enabled, the system waits for the F1 key to be pressed when error occurs. Configuration options: [Disabled] [Enabled]

Hit 'DEL' Message Display [Enabled]

When set to Enabled, the system displays the message "Press DEL to run Setup" during POST. Configuration options: [Disabled] [Enabled]

Interrupt 19 Capture [Disabled]

When set to [Enabled], this function allows the option ROMs to trap Interrupt 19. Configuration options: [Disabled] [Enabled]

4.6.3 Security

The Security menu items allow you to change the system security settings. Select an item then press <Enter> to display the configuration options.

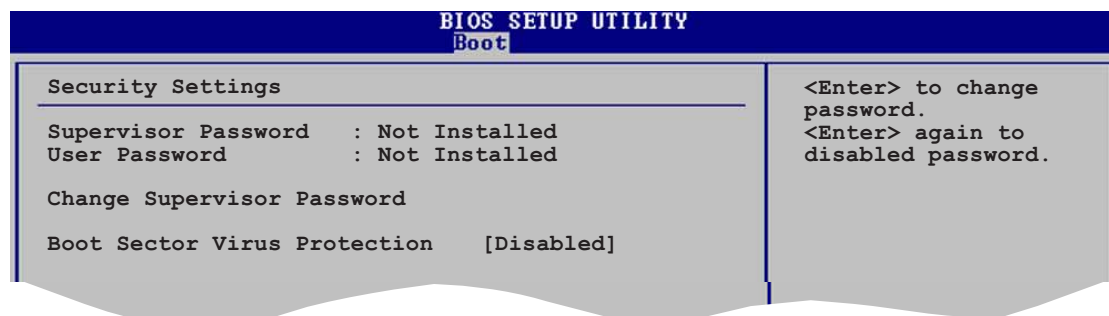

Change Supervisor Password

Select this item to set or change the supervisor password. The Supervisor Password item on top of the screen shows the default **Not Installed**. After you set a password, this item shows **Installed**.

To set a Supervisor Password:

1. Select the Change Supervisor Password item and press <Enter>.
2. From the password box, type a password composed of at least six letters and/or numbers, then press <Enter>.
3. Confirm the password when prompted.

The message "Password Installed" appears after you successfully set your password.

To change the supervisor password, follow the same steps as in setting a user password.

To clear the supervisor password, select the Change Supervisor Password then press <Enter>. The message "Password Uninstalled" appears.



If you forget your BIOS password, you can clear it by erasing the CMOS Real Time Clock (RTC) RAM. See section “2.6 Jumpers” for information on how to erase the RTC RAM.

After you have set a supervisor password, the other items appear to allow you to change other security settings.

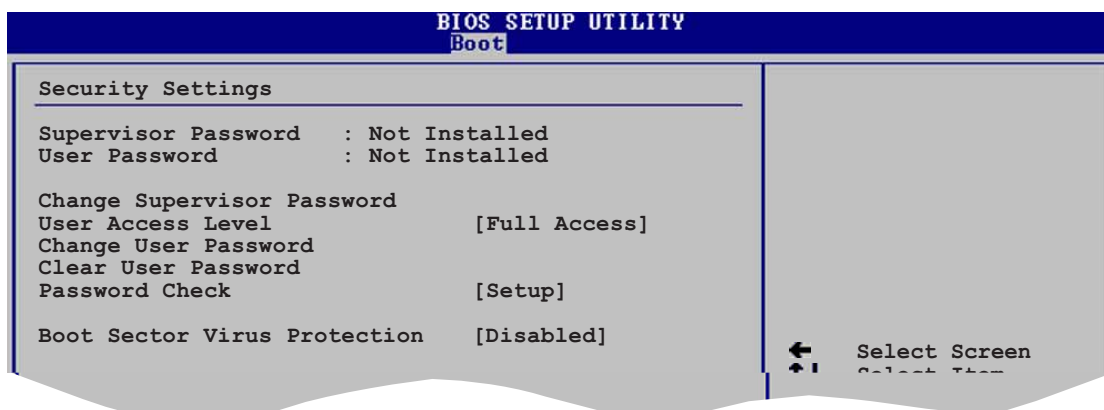

User Access Level (Full Access]

This item allows you to select the access restriction to the Setup items. Configuration options: [No Access] [View Only] [Limited] [Full Access]

No Access prevents user access to the Setup utility.

View Only allows access but does not allow change to any field.

Limited allows changes only to selected fields, such as Date and Time.

Full Access allows viewing and changing all the fields in the Setup utility.

Change User Password

Select this item to set or change the user password. The User Password item on top of the screen shows the default **Not Installed**. After you set a password, this item shows **Installed**.

To set a User Password:

1. Select the Change User Password item and press <Enter>.
2. On the password box that appears, type a password composed of at least six letters and/or numbers, then press <Enter>.
3. Confirm the password when prompted.

The message “Password Installed” appears after you set your password successfully.

To change the user password, follow the same steps as in setting a user password.

Clear User Password

Select this item to clear the user password.

Password Check [Setup]

When set to [Setup], BIOS checks for user password when accessing the Setup utility. When set to [Always], BIOS checks for user password both when accessing Setup and booting the system.

Configuration options: [Setup] [Always]

Boot Sector Virus Protection [Disabled]

Allows you to enable or disable the boot sector virus protection.

Configuration options: [Disabled] [Enabled]

4.7 Exit menu

The Exit menu items allow you to load the optimal or failsafe default values for the BIOS items, and save or discard your changes to the BIOS items.

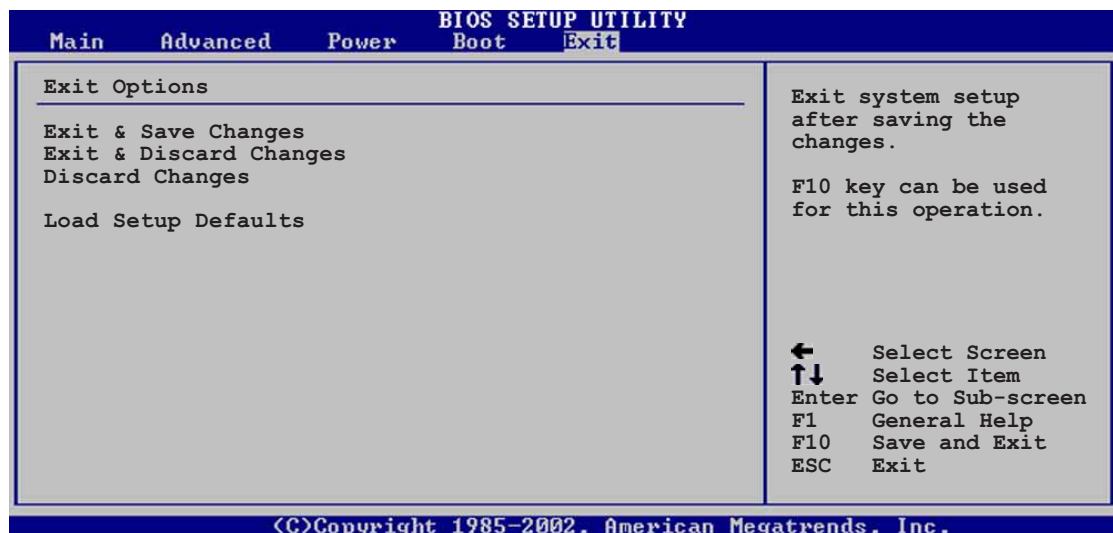

Pressing <Esc> does not immediately exit this menu. Select one of the options from this menu or <F10> from the legend bar to exit.

Exit & Save Changes

Once you are finished making your selections, choose this option from the Exit menu to ensure the values you selected are saved to the CMOS RAM. An onboard backup battery sustains the CMOS RAM so it stays on even when the PC is turned off. When you select this option, a confirmation window appears. Select **Yes** to save changes and exit.



If you attempt to exit the Setup program without saving your changes, the program prompts you with a message asking if you want to save your changes before exiting. Press <Enter> to save the changes while exiting.

Exit & Discard Changes

Select this option only if you do not want to save the changes that you made to the Setup program. If you made changes to fields other than System Date, System Time, and Password, the BIOS asks for a confirmation before exiting.

Discard Changes

This option allows you to discard the selections you made and restore the previously saved values. After selecting this option, a confirmation appears. Select **Yes** to discard any changes and load the previously saved values.

Load Setup Defaults

This option allows you to load the default values for each of the parameters on the Setup menus. When you select this option or if you press <F5>, a confirmation window appears. Select **Yes** to load default values. Select **Exit & Save Changes** or make other changes before saving the values to the non-volatile RAM.

This chapter describes the contents of the support CD that comes with the motherboard package.

5 Software support

Chapter summary

5.1	Installing an operating system	5-1
5.2	Support CD information	5-1
5.3	Software information	5-8
5.4	RAID configurations	5-15
5.5	Creating a RAID driver disk	5-37

5.1 Installing an operating system

This motherboard supports Windows® 2000/2003 Server/XP operating systems (OS). Always install the latest OS version and corresponding updates to maximize the features of your hardware.



- Motherboard settings and hardware options vary. Use the setup procedures presented in this chapter for reference only. Refer to your OS documentation for detailed information.
- Make sure that you install Windows® 2000 Service Pack 4 or the Windows® XP Service Pack 1 or later versions before installing the drivers for better compatibility and system stability.

5.2 Support CD information

The support CD that came with the motherboard package contains the drivers, software applications, and utilities that you can install to avail all motherboard features.



The contents of the support CD are subject to change at any time without notice. Visit the ASUS website(www.asus.com) for updates.

5.2.1 Running the support CD

Place the support CD to the optical drive. The CD automatically displays the **Drivers** menu if Autorun is enabled in your computer.

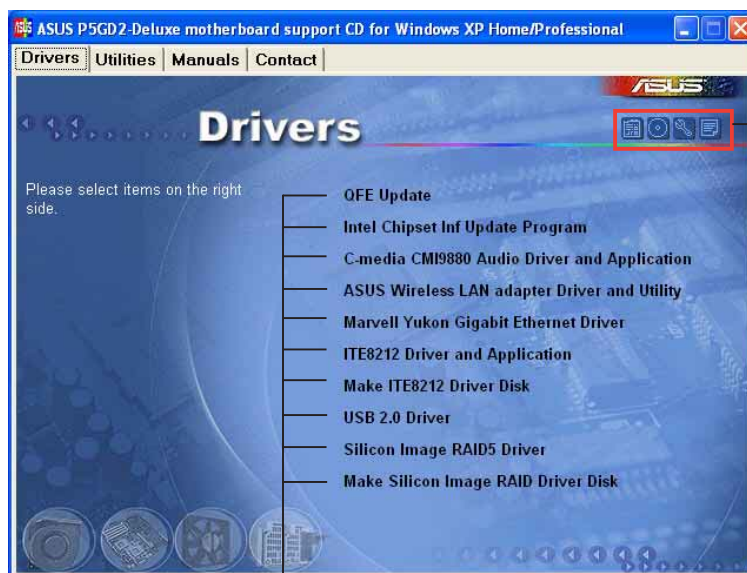

Click an icon to display support CD/motherboard information

Click an item to install



If **Autorun** is NOT enabled in your computer, browse the contents of the support CD to locate the file **ASSETUP.EXE** from the BIN folder. Double-click the **ASSETUP.EXE** to run the CD.

5.2.2 Drivers menu

The drivers menu shows the available device drivers if the system detects installed devices. Install the necessary drivers to activate the devices.

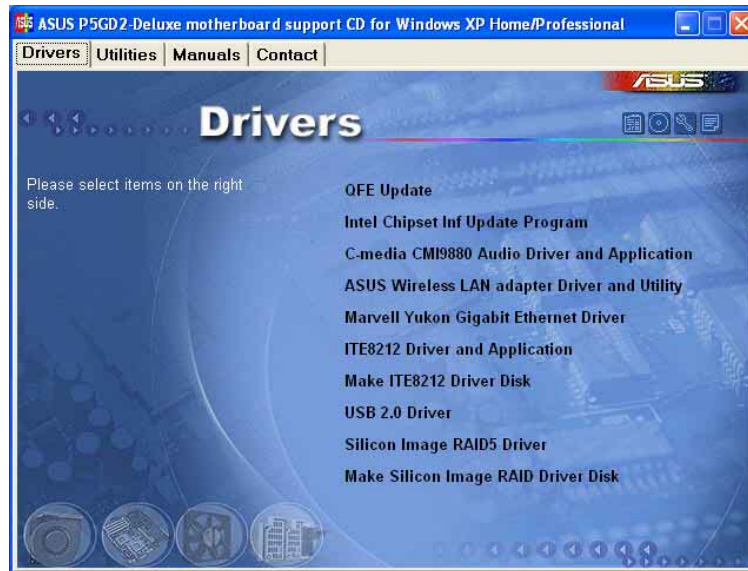

QFE Update

Installs the Quick Fix Engineering (QFE) driver updates.

Intel Chipset Inf Update Program

This item installs the Intel® Chipset INF Update Program. This driver enables Plug-n-Play INF support for the Intel® chipset components on the motherboard. When installed to the target system, this driver provides the method for configuring the chipset components.

You can install this utility using three different modes: interactive, silent, or unattended preload. Installing the driver in interactive mode requires user input during installation. User input is not required when installing the driver in silent or unattended preload modes. Refer to the online help or readme file that came with the utility for details.

C-MEDIA CMI9880 Audio Driver and Application

Installs the C-MEDIA® CMI9880 audio driver and application.

Marvell Yukon Gigabit Ethernet Driver

Installs the Marvell® Yukon 88E8053 PCI Express™ Gigabit LAN driver that provides up to 1000 Mbps data transfer rates.

IT8212 Driver and Application

Installs the IT8212 driver and application.

USB 2.0 Driver

Installs the USB 2.0 driver.

Silicon Image RAID5 Driver

Installs the Silicon Image 3114R RAID5 driver.

Make Silicon Image RAID Driver Disk

Allows you to create a RAID5 driver disk for the Silicon Image RAID 5 configuration.



The screen display and drivers option may not be the same for different operating system versions.

5.2.3 Utilities menu

The Utilities menu shows the applications and other software that the motherboard supports.

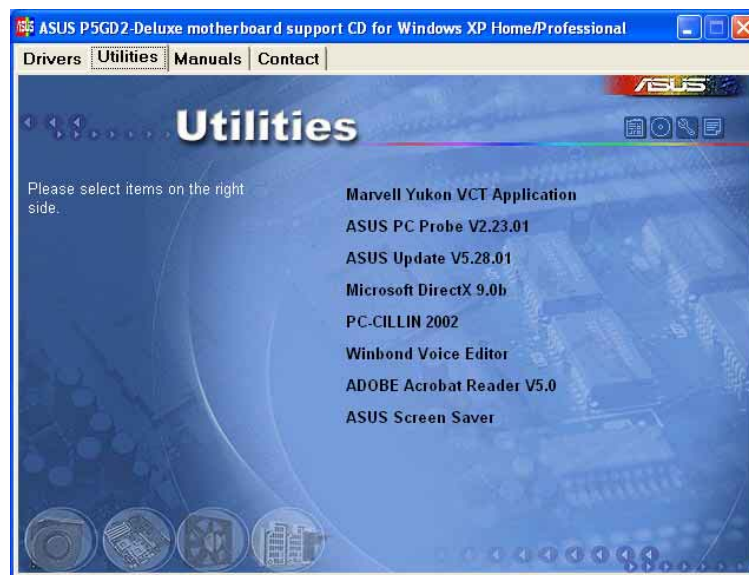

Marvell Yukon VCT Application

Installs the Marvell® Yukon VCT application.

ASUS PC Probe

This smart utility monitors the fan speed, CPU temperature, and system voltages, and alerts you of any detected problems. This utility helps you keep your computer in healthy operating condition.

ASUS Update

Allows you to download the latest version of the BIOS from the ASUS website.



Before using the ASUS Update, make sure that you have an Internet connection so you can connect to the ASUS website.

AI Booster

Installs the ASUS AI Booster software.

Microsoft DirectX

Installs the Microsoft® DirectX 9.0b driver.

PC-cillin

Installs the PC-cillin anti-virus program. View the PC-cillin online help for detailed information.

Winbond Voice Editor

This program is for recording and customizing wave files for the ASUS POST Reporter™. Use this program to change the default vocal POST messages. See section “3.2 Vocal POST Messages” for a list of the default messages.

ADOBE Acrobat Reader

Installs the Adobe® Acrobat® Reader V5.0.

ASUS Screen Saver

Installs the ASUS screen saver.



The screen display and utilities option may not be the same for different operating system versions.

5.2.4 Manuals menu

The Manuals menu contains a list of supplementary user manuals. Click an item to open the folder of the user manual.



Install the Adobe® Acrobat® Reader from the Utilities menu before opening the manual files.

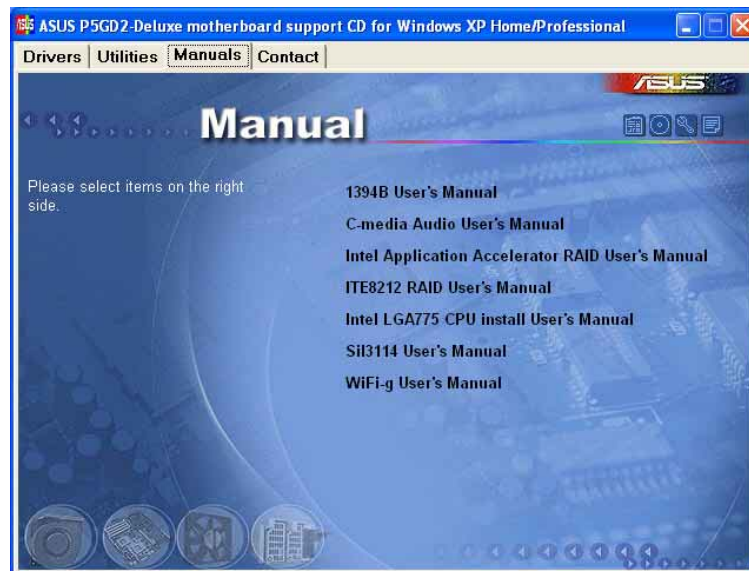

C-Media Audio User's Manual

Allows you to open the C-Media® Audio user's manual.

Intel Application Accelerator RAID User's Manual

Allows you to open the Intel® Application Accelerator RAID User's manual.

ITE8212 RAID User's Manual

Allows you to open the ITE® 8212F RAID User's manual.

Intel LGA775 CPU Install User's Manual

Allows you to open the Intel® LGA775 CPU installation user's manual.

Sil3114 User's Manual

Allows you to open the Silicon Image Sil3114 RAID controller user's manual.

WiFi-g User's Manual

Allows you to open the ASUS® WiFi-g user's manual.



The screen display and manuals option may not be the same for different operating system versions.

5.2.5 ASUS Contact information

Click the **Contact** tab to display the ASUS contact information. You can also find this information on the inside front cover of this user guide.

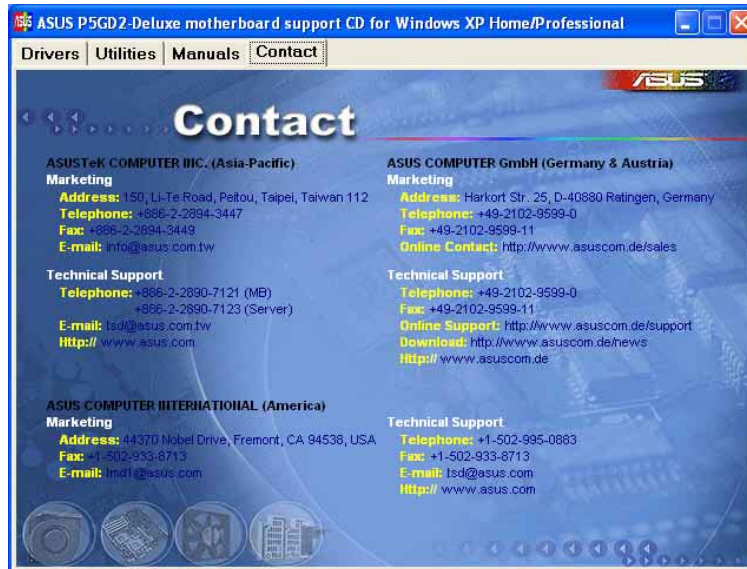

5.2.6 Other information

The icons on the top right corner of the screen give additional information on the motherboard and the contents of the support CD. Click an icon to display the specified information.

Motherboard Info

Displays the general specifications of the motherboard.

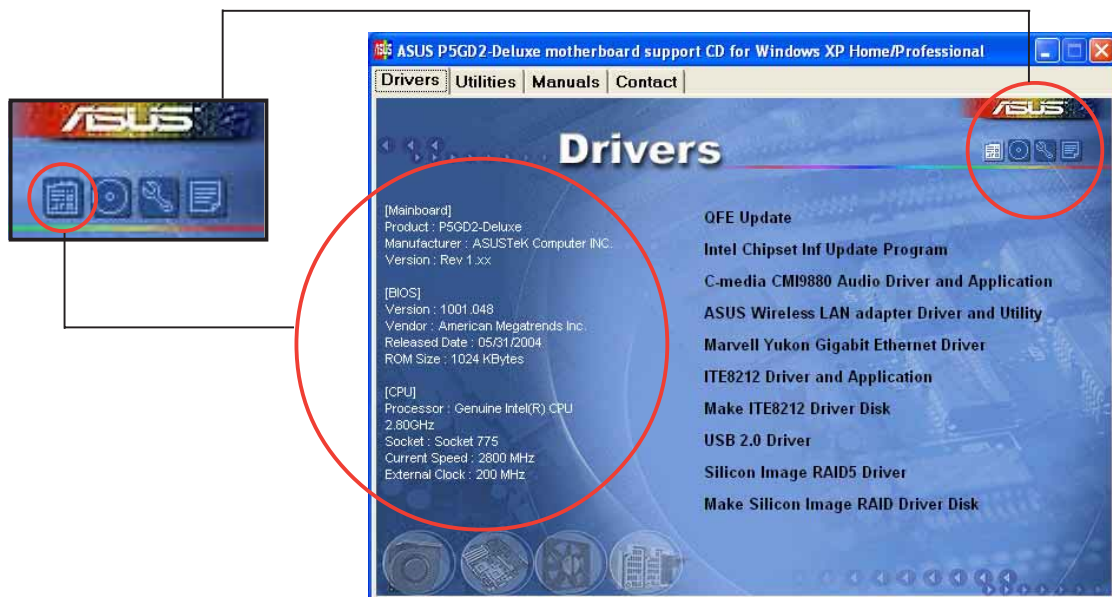

Browse this CD

Displays the support CD contents in graphical format.

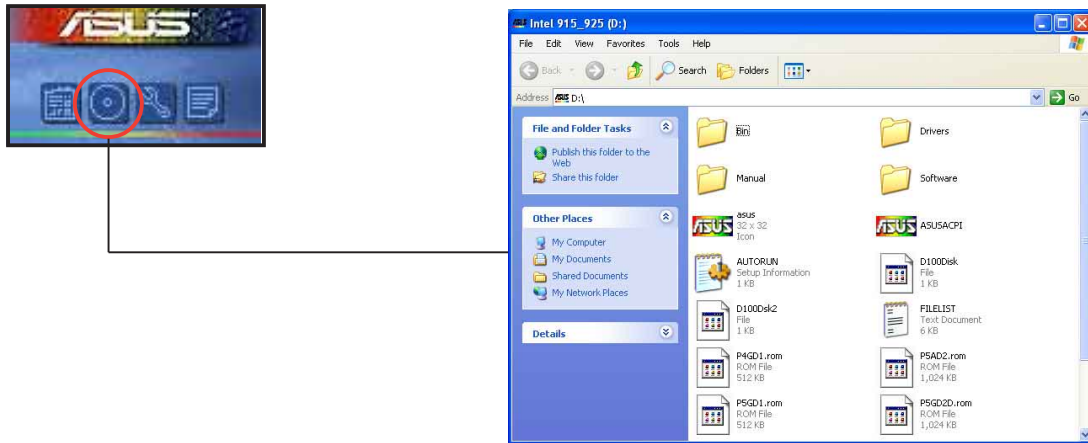

Technical support Form

Displays the ASUS Technical Support Request Form that you have to fill out when requesting technical support.

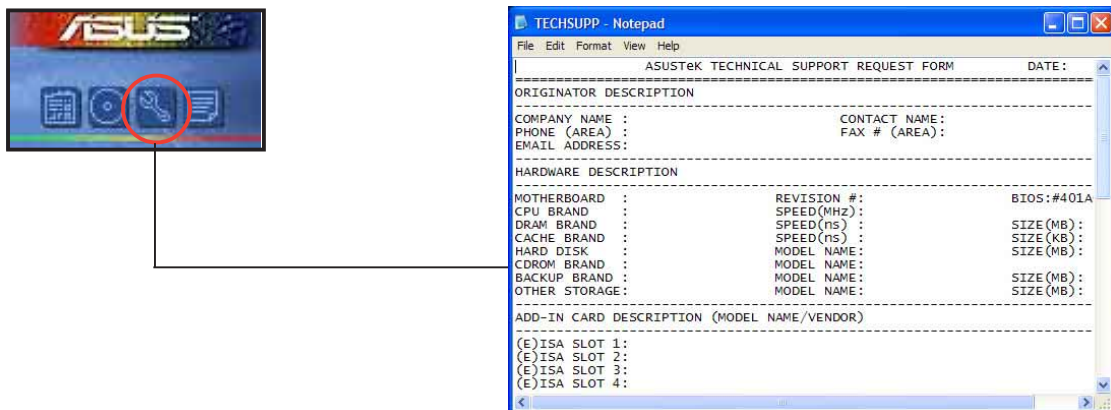

Filelist

Displays the contents of the support CD and a brief description of each in text format.



5.3 Software information

Most of the applications in the support CD have wizards that will conveniently guide you through the installation. View the online help or readme file that came with the software application for more information.

5.3.1 ASUS MyLogo2™

The ASUS MyLogo2™ utility lets you customize the boot logo. The boot logo is the image that appears on screen during the Power-On-Self-Tests (POST). The ASUS MyLogo2™ is automatically installed when you install the **ASUS Update** utility from the support CD. See section “5.2.3 Utilities menu” for details.



- Before using the ASUS MyLogo2™, use the AFUDOS utility to make a copy of your original BIOS file, or obtain the latest BIOS version from the ASUS website. See section “4.1.3 AFUDOS utility”.
- Make sure that the BIOS item **Full Screen Logo** is set to [Enabled] if you wish to use ASUS MyLogo2. See section “4.6.2 Boot Settings Configuration”.
- You can create your own boot logo image in GIF, JPG, or BMP file formats.

To launch the ASUS MyLogo2™:

1. Launch the ASUS Update utility. Refer to section “4.1.5 ASUS Update utility” for details.
2. Select **Options** from the drop down menu, then click **Next**.
3. Check the option **Launch MyLogo to replace system boot logo before flashing BIOS**, then click **Next**.
4. Select **Update BIOS from a file** from the drop down menu, then click **Next**.
5. When prompted, locate the new BIOS file, then click **Next**. The ASUS MyLogo2™ window appears.
6. From the left window pane, select the folder that contains the image you intend to use as your boot logo.



7. When the logo images appear on the right window pane, select an image to enlarge by clicking on it.



8. Adjust the boot image to your desired size by selecting a value on the **Ratio** box.



9. When the screen returns to the ASUS Update utility, flash the original BIOS to load the new boot logo.
10. After flashing the BIOS, restart the computer to display the new boot logo during POST.

5.3.2 AI NET2

The Marvell® Virtual Cable Tester™ (VCT) is a cable diagnostic utility that reports LAN cable faults and shorts using the Time Domain Reflectometry (TDR) technology. The VCT detects and reports open and shorted cables, impedance mismatches, pair swaps, pair polarity problems, and pair skew problems of up to 64 ns at one meter accuracy.

The VCT feature reduces networking and support costs through a highly manageable and controlled network system. This utility can be incorporated in the network systems software for ideal field support as well as development diagnostics.

Using the Virtual Cable Tester™

To use the the Marvell® Virtual Cable Tester™ utility:

1. Launch the VCT utility from the Windows® desktop by clicking **Start > All Programs > Marvell > Virtual Cable Tester**.
2. Click **Virtual Cable Tester** from the menu to display the screen below.

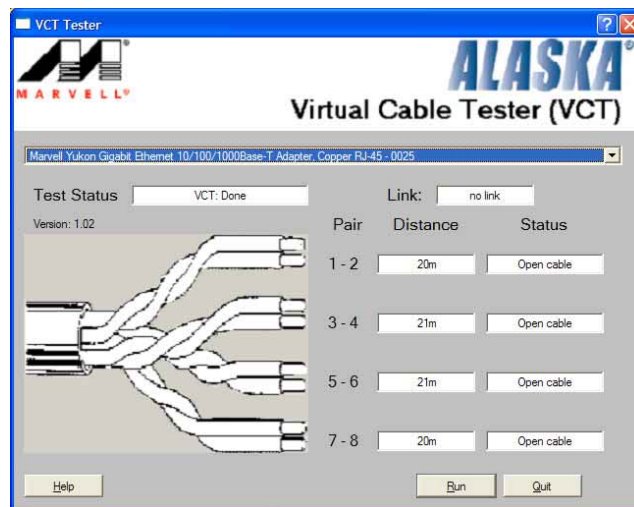

3. Click the **Run** button to perform a cable test.



- The VCT only runs on systems with Windows® XP or Windows® 2000 operating systems.
- The VCT utility only tests Ethernet cables connected to Gigabit LAN port(s).
- The **Run** button on the Virtual Cable Tester™ main window is disabled if no problem is detected on the LAN cable(s) connected to the LAN port(s).
- If you want the system to check the LAN cable before entering the OS, enable the **POST Check LAN cable** item in the BIOS. See section “4.4.2 LAN Cable Status” on page 4-21 for details.

5.3.3 C-Media 3D audio configuration

The C-Media 3D Audio Configuration utility allows easy installation and set up of audio devices through a user-friendly interface. The utility is automatically installed when you install the C-Media CMI9880 audio driver and application from the motherboard support CD. Refer to section “5.2.2 Drivers menu.”

Launching the C-Media 3D Audio Configuration utility

Launch the C-Media 3D Audio Configuration utility by double clicking the C-Media icon on the Windows® taskbar.



Using the C-Media 3D Audio Configuration utility

The C-Media 3D Audio Configuration interface has five tabs: Main Setting, Mixer, Effect, Device Setting, and Information. Click a tab to display the details.

Main Setting

The **Main Setting** tab allows you to check the audio system status, configure the audio ports, set the speaker and audio DSP modes, and test the speaker output.

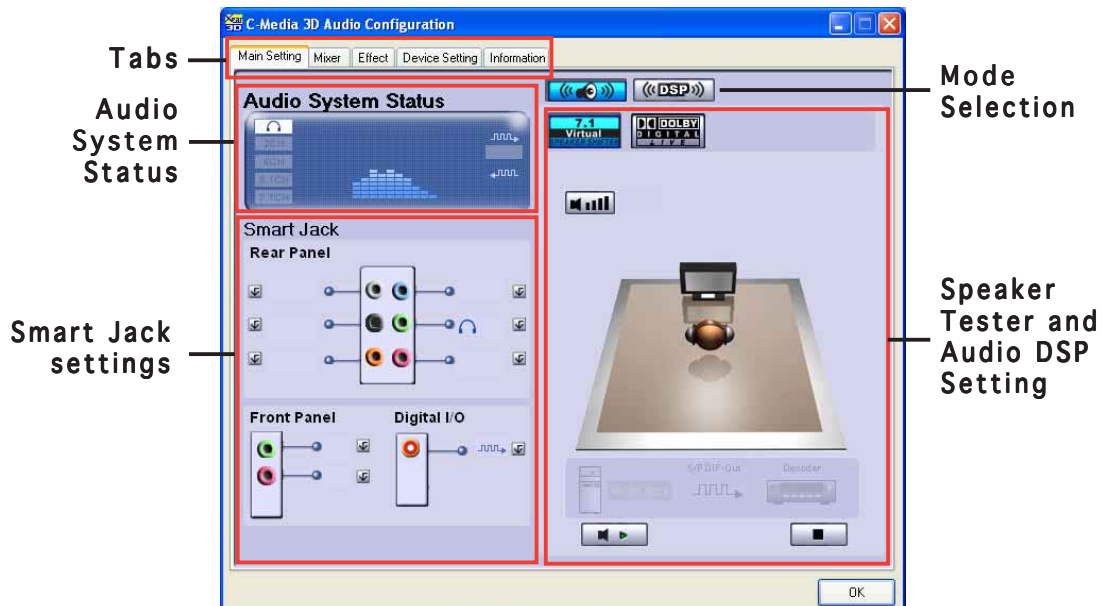

Audio System Status. This section displays the output mode status, the real-time audio playback spectrum, and the digital I/O status. The number of speakers configured in the system determines the output mode status.

Smart Jack Setting. You can configure the function of the rear panel, front panel, and digital I/O audio ports from this section. Click the  Smart Jack setting button that corresponds to the port that you wish to configure.

Mode Selection. This section allows you to set the Speaker Tester or the Digital Signal Processing (DSP). Click the button to change the audio modes.

Speaker Tester and Audio DSP Setting. You can configure your speaker setup and the audio DSP settings in this section. Click the **Play** or the **Stop** button to listen to the speakers or click the **Volume** button to adjust the speakers' volume.

Mixer

The **Mixer** tab allows you to adjust the audio input and the recording output volume of devices connected to the system rear panel and front panel audio ports.



Effect

The **Effect** tab allows you to control the environment emulation, set the environment size, and adjust the equalizer settings.

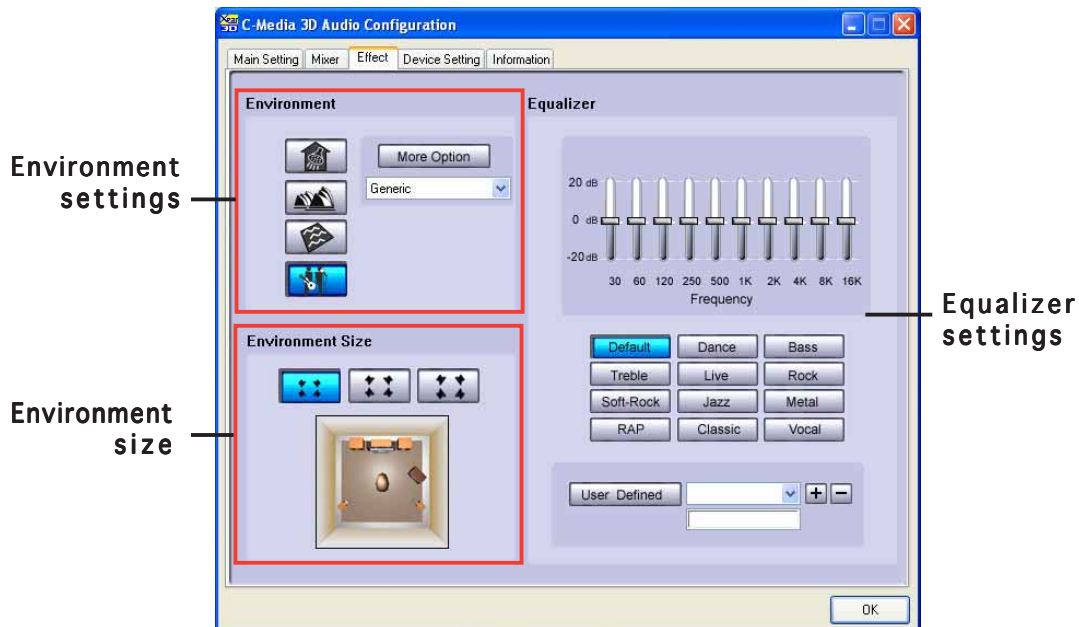

Environment. This section contains various pre-programmed environment emulations. There are four featured materials that emulate the bathroom, concert hall, underwater, and music pub environments. Click the corresponding button to set an environment emulation. To set other environment emulations, click the **More Option** list box.

Environment Size. This section allows you to select the size of your room for an appropriate audio output. There are three room size models provided for the environment size emulation. Click any of the environment size buttons to set.

Equalizer. The Equalizer section allows you to adjust the amplifier frequency. Use the 10-band equalizer to individually control the different frequency bands of your speaker system, or click a music style preset to load a pre-defined equalizer setting. Click the **User Defined** button to save or load your customized equalizer settings.

Device Setting

The **Device Setting** tab allows you to enable the audio CODEC multi-streaming feature, select a sound playback, and sound recording devices.

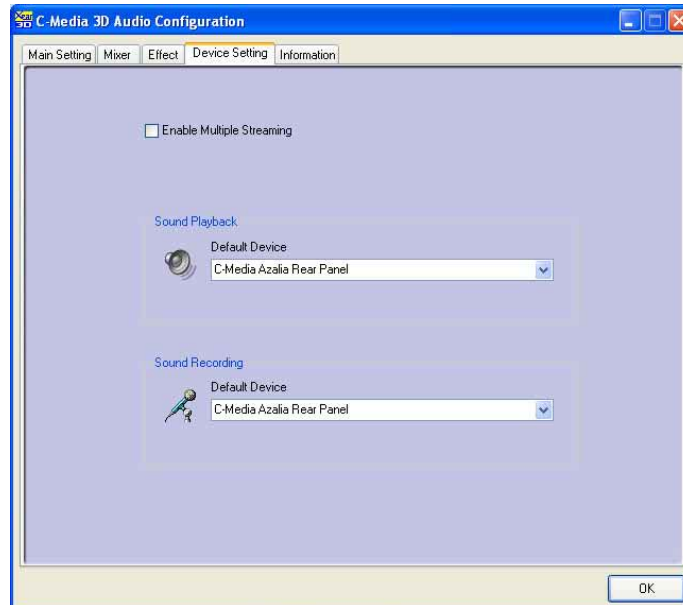

Information

The **Information** tab displays your 3D audio engine, audio CODEC, audio driver, audio controller, and DirectX information.



5.4 RAID configurations

The motherboard comes with the Silicon Image Sil3114, ITE 8212, and the Intel® ICH6R Southbridge RAID controllers that allow you to configure IDE and Serial ATA hard disk drives as RAID sets. The motherboard supports the following RAID configurations.

RAID 0 (*Data striping*) optimizes two identical hard disk drives to read and write data in parallel, interleaved stacks. Two hard disks perform the same work as a single drive but at a sustained data transfer rate, double that of a single disk alone, thus improving data access and storage. Use of two new identical hard disk drives is required for this setup.

RAID 1 (*Data mirroring*) copies and maintains an identical image of data from one drive to a second drive. If one drive fails, the disk array management software directs all applications to the surviving drive as it contains a complete copy of the data in the other drive. This RAID configuration provides data protection and increases fault tolerance to the entire system. Use two new drives or use an existing drive and a new drive for this setup. The new drive must be of the same size or larger than the existing drive.

RAID 0+1 is *data striping* and *data mirroring* combined without parity (redundancy data) having to be calculated and written. With the RAID 0+1 configuration you get all the benefits of both RAID 0 and RAID 1 configurations. Use four new hard disk drives or use an existing drive and three new drives for this setup.

RAID 5 stripes both data and parity information across three or more hard disk drives. Among the advantages of RAID 5 configuration include better HDD performance, fault tolerance, and higher storage capacity. The RAID 5 configuration is best suited for transaction processing, relational database applications, enterprise resource planning, and other business systems. Use a minimum of three identical hard disk drives for this setup.

RAID 10 is a striped configuration with RAID 1 segments whose segments are RAID 1 arrays. This configuration has the same fault tolerance as RAID 1, and has the same overhead for fault-tolerance as mirroring alone. RAID 10 achieves high input/output rates by striping RAID 1 segments. In some instances, a RAID 10 configuration can sustain multiple simultaneous drive failure. A minimum of four hard disk drives is required for this setup.

JBOD (*Spanning*) stands for **Just a Bunch of Disks** and refers to hard disk drives that are not yet configured as a RAID set. This configuration stores the same data redundantly on multiple disks that appear as a single disk on the operating system. Spanning does not deliver any advantage over using separate disks independently and does not provide fault tolerance or other RAID performance benefits.



If you use either Windows® XP or Windows® 2000 operating system (OS), copy first the RAID driver from the support CD to a floppy disk before creating RAID configurations. Refer to section “5.7 Creating a RAID driver disk” for details.

5.4.1 Installing hard disks

The motherboard supports Ultra DMA /133/100/66 and Serial ATA hard disk drives. For optimal performance, install identical drives of the same model and capacity when creating a disk array.

Installing Parallel ATA hard disks

To install IDE hard disks for a RAID configuration:

1. Set the jumpers of each hard disk as Master/Master or Slave/Slave.
2. Install the hard disks into the drive bays.
3. Connect the HDD signal cables.
4. Connect a 4-pin power cable to the power connector on each drive.

Installing Serial ATA (SATA) hard disks

To install the SATA hard disks for a RAID configuration:

1. Install the SATA hard disks into the drive bays.
2. Connect the SATA signal cables.
3. Connect a SATA power cable to the power connector on each drive.

5.4.2 Silicon Image RAID configurations

The Silicon Image RAID controller supports RAID 0, RAID 1, RAID 10, JBOD, and RAID 5 configurations. Use the Silicon Image RAID utility to configure a disk array.

Setting the BIOS RAID items

After installing the hard disk drives, make sure to set the necessary RAID items in the BIOS before setting your RAID configuration.

To set the BIOS RAID items:

1. Boot the system and press during the Power-On Self-Test (POST) to enter the BIOS Setup Utility.
2. From the **Advanced > Onboard Devices Configuration** menu item in the BIOS set the **Silicon Image Controller** item to RAID Mode.
3. Save your changes and Exit Setup.

Launching the Silicon Image Array Management Software

Launch the Silicon Image Array Management software from Windows® XP by clicking the **Start** button and selecting **All Programs > Silicon Image > Sam**



-
- For details on the Silicon Image SATAraid™ RAID configuration, refer to the “Sil3114 User’s Manual” in your motherboard support CD.
 - A RAID 5 configuration requires at least 1 GB of system memory and 3 GHz processor core speed for optimum performance.
 - You can only set the SATALink™ RAID 5 and JBOD configuration using the SATALink™ SATA RAID Management Software.
 - Make sure to install the Silicon Image SATA Link Sil 3114 driver and the Silicon Image RAID 5 Array Management Utility before using RAID 5 configuration.
-

Entering the Silicon Image BIOS RAID Configuration Utility

To enter the Silicon Image BIOS RAID configuration utility:

1. Boot up your computer.
2. During POST, press <Ctrl+S> or <F4>.



The RAID BIOS setup screens shown in this section are for reference only, and may not exactly match the items on your screen.

```
RAID Configuration Utility - Silicon Image Inc. Copyright (C) 2004

MAIN MENU :
Create RAID set
Delete RAID set
Rebuild Raid1 set
Resolve Conflicts
Low Level Format
Logical Drive Info

HELP :
Press "Enter" to create
RAID set

PHYSICAL DRIVE :
0 XXXXXXXXXXXX          XXXXXMB
1 XXXXXXXXXXXX          XXXXXMB
2 XXXXXXXXXXXX          XXXXXMB
3 XXXXXXXXXXXX          XXXXXMB

LOGICAL DRIVE :
STXXXXXXXXXX          XXXXXMB
STXXXXXXXXXX          XXXXXMB
STXXXXXXXXXX          XXXXXMB
STXXXXXXXXXX          XXXXXMB

↑↓:Select Menu  ESC:Previous Menu  Enter:Select  Ctrl-E:Exit
```

On the upper right corner of the screen is the Help message box. The message describes the function of each menu item. At the bottom of the screen is the legend box. The keys on the legend box allow you to navigate through the setup menu options. The following lists the keys found in the legend box and their corresponding functions.

↑, ↓	:	Select/Move to the next item
ESC	:	Previous Menu
Enter	:	Select
Ctrl-E	:	Exit

Creating a RAID 0 set (Striped)

To create a RAID set:

1. From the Silicon Image configuration utility main menu, select **Create RAID set** then press <Enter> to display an option menu.

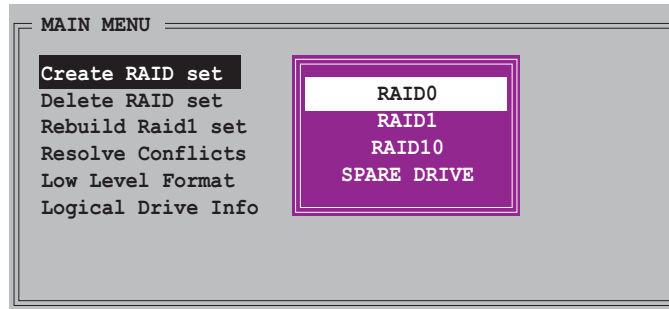

2. Select **RAID 0** then press <Enter> to display the following.

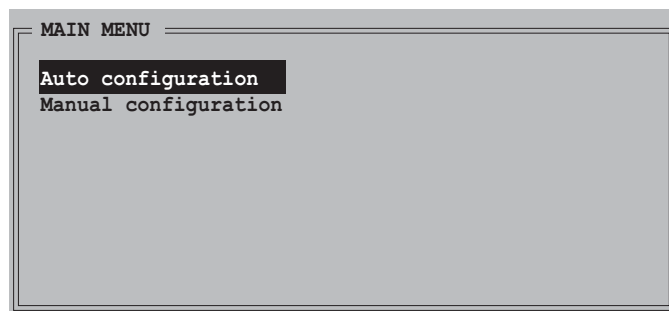

3. Select your desired method of configuration.
Auto configuration
 - a. Select Auto Configuration the press <Enter>.
 - b. The utility prompts a confirmation message, press <Y>.



By default, Auto configuration sets the stripe size to 64K and sets the logical drives based on the physical drives installed.

Manual configuration

- a. Select **Manual configuration** and press <Enter>. The following pop-up menu appears.

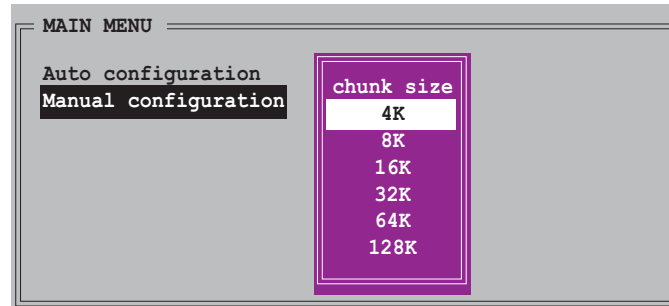

TIP: For server systems, use of a lower array block size is recommended. For multimedia computer systems used mainly for audio and video editing, a higher array block size is recommended for optimum performance.

- b. Use the up or down arrow keys to select a chunk size appropriate to your drive usage then press <Enter>. The selection bar moves to the Physical Drive menu.

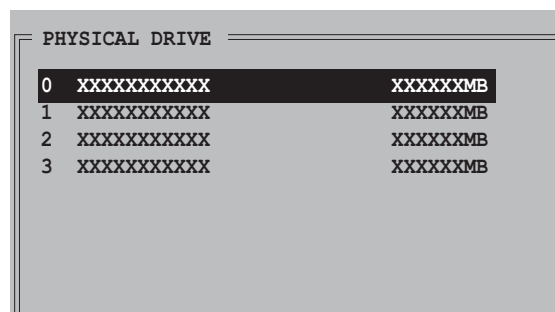

- c. Using the up or down arrow keys, select a drive then press <Enter> to set the first drive of the RAID set. Repeat the same procedure to set the second, third, and fourth drive. The number of available drives depend on the installed and enabled physical drives in the system.
- d. The utility prompts a confirmation message, press <Y> to confirm or <N> to return to the configuration Main Menu.

Creating a RAID 1 set (Mirrored)

To create a RAID 1 set:

1. From the Silicon Image configuration utility main menu, select **Create RAID set** then press <Enter>. The following sub-menu appears.

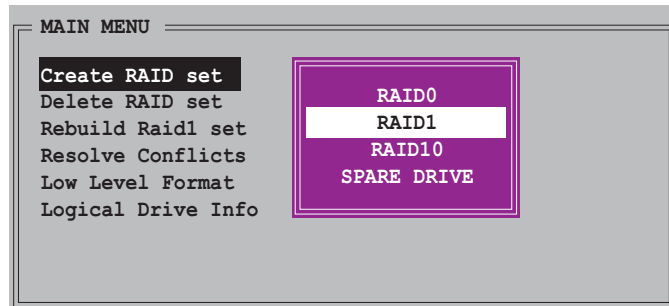

2. Select **RAID 1** then press <Enter> to display the following.

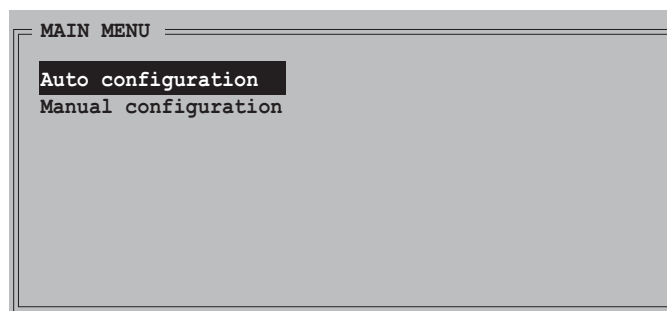

3. Select your desired method of configuration.
Auto configuration
 - a. Select Auto Configuration then press <Enter>.
 - b. The utility prompts a confirmation message. Press <Y> to confirm or <N> to return to the configuration Main Menu.



- Auto-configuration creates a RAID 1 set without backup copy.
- When migrating a single hard disk drive to a RAID 1 set, use of the Manual configuration is recommended.

Manual configuration

- a. Select **Manual configuration** and press <Enter>. The selection bar moves to the Physical Drives menu.

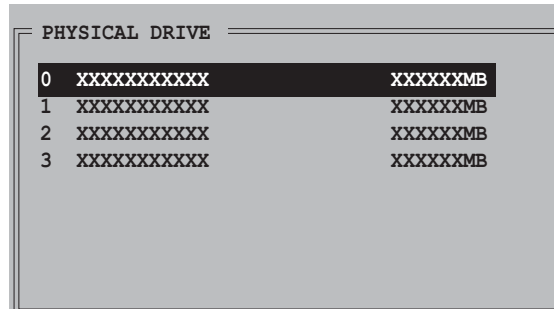

- b. Using the up or down arrow keys, select the *source drive* and press <Enter>.
- c. Repeat step b to select the *target drive*.
- d. After selecting the source and target drives, the following pop-up menu appears.

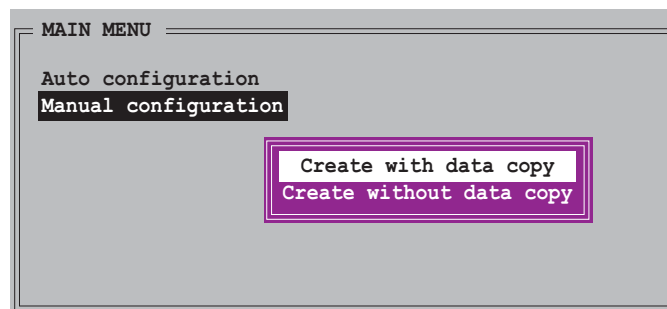

- The **Create with data copy** option allows you to copy the current data from the source drive to the mirror drive. The **Create without data copy** option disables the disk copy function of the Mirrored set.
- If you selected **Create without data copy**, the RAID 1 set must be repartitioned and reformatted to guarantee the consistency of its contents.
- Select **Create with data copy** if you have important data in your source drive.

- e. If you selected **Create with data copy**, the following pop-up menu appears.

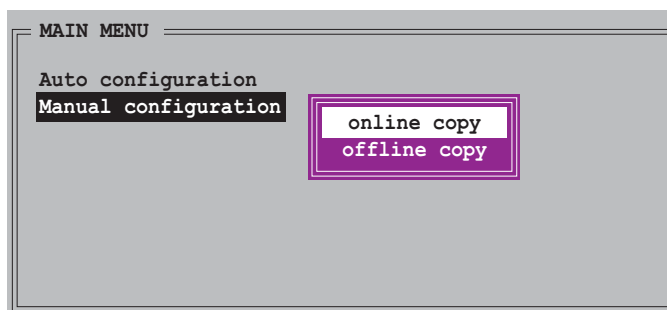

The **online copy** option automatically copies the data to the target drives on the background while writing to the source drives. The **offline copy** option allows you to copy the contents of the source drive to the target drives now.

- f. Use the up or down arrow keys to select desired copy method, then press <Enter>.
- g. The utility prompts a confirmation message. Press <Y> to confirm or <N> to return to the configuration Main Menu.



A copy progress appears if you previously selected offline copy.

Creating a RAID 10 set (Mirrored+Striped)

To create a RAID 10 set:

1. From the Silicon Image configuration utility main menu, select **Create RAID set** then press <Enter>. The following sub-menu appears.

To create a RAID 10 set:

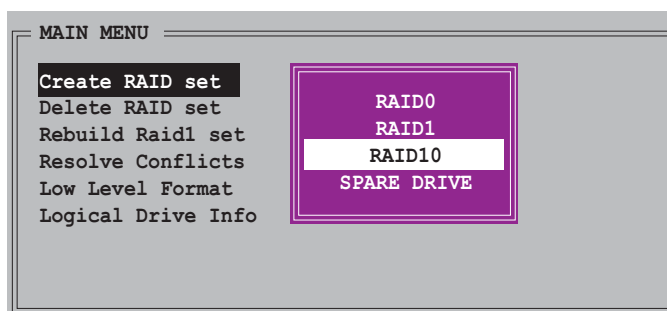

2. Select **RAID 10** then press <Enter> to display the following.

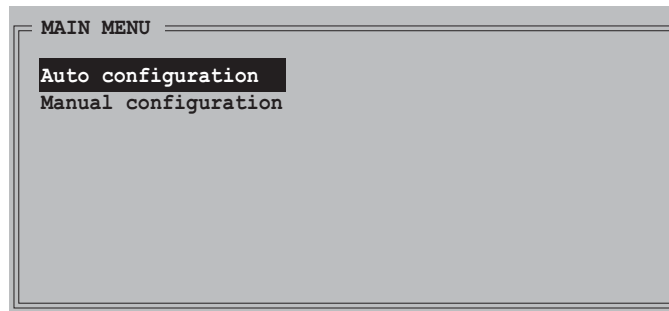

3. Select your desired method of configuration.
Auto configuration
 - a. Select Auto Configuration then press <Enter>.
 - b. The utility prompts a confirmation message. Press <Y> to confirm or <N> to return to the configuration Main Menu.



Auto-configuration creates a RAID 10 set without backup copy.

Manual configuration

- a. Select **Manual configuration** and press <Enter>. The following pop-up menu appears.

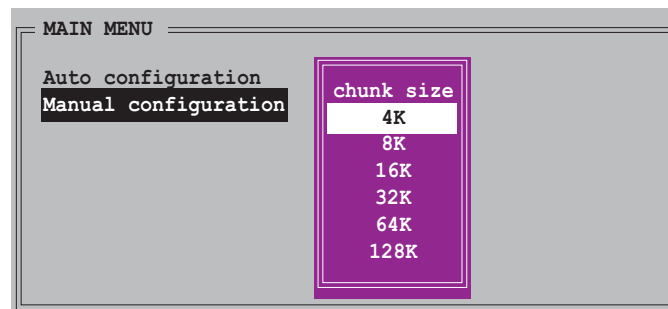

TIP: For server systems, use of a lower array block size is recommended. For multimedia computer systems used mainly for audio and video editing, a higher array block size is recommended for optimum performance.

- b. Use the up or down arrow keys to select a chunk size appropriate to your drive usage then press <Enter>. The selection bar moves to the Physical Drive menu.

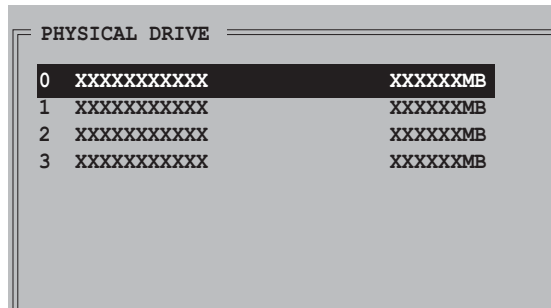

- c. Using the up or down arrow keys, select a drive then press <Enter> to set the first drive of the RAID set.
- d. Repeat step c to set the second, third, and fourth drive. The number of available drives depend on the installed and enabled physical drives in the system.
- e. After setting the RAID drives, the following pop-up menu appears.

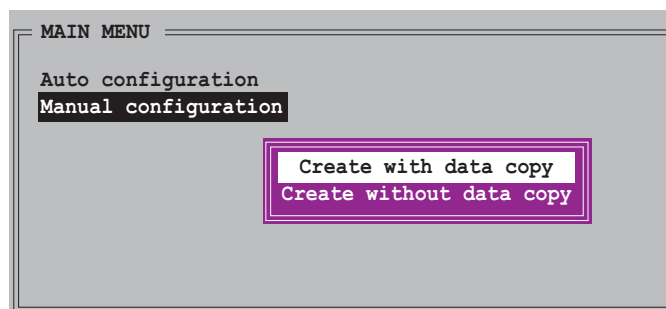

- The **Create with data copy** option allows you to copy the current data from the source drive to the mirror drive. The **Create without data copy** option disables the disk copy function of the Mirrored set.
- If you selected **Create without data copy**, the RAID 1 set must be repartitioned and reformatted to guarantee the consistency of its contents.
- Select **Create with data copy** if you have important data in your source drive.

- f. If you selected **Create with data copy**, the following pop-up menu appears.

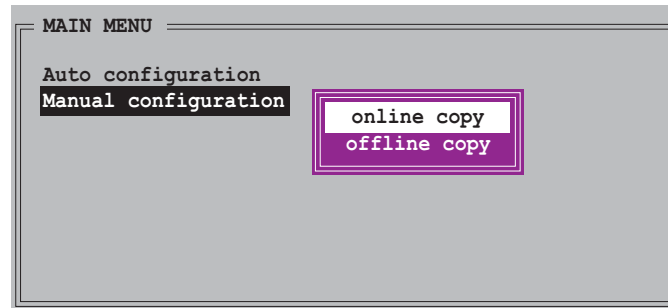

The **online copy** option automatically copies the data to the target drives on the background while writing to the source drives. The **offline copy** option allows you to copy the contents of the source drive to the target drives now.

- g. Use the up or down arrow keys to select desired copy method, then press <Enter>.
- h. The utility prompts a confirmation message. Press <Y> to confirm or <N> to return to the configuration Main Menu.



A copy progress appears if you previously selected offline copy.

Creating a RAID 5 or JBOD set

Use the Silicon Image Array Management software from Windows® XP to create a RAID 5 or JBOD configuration.

5.4.3 Intel® RAID configurations

This motherboard supports RAID 0 and RAID 1 configurations for Serial ATA hard disk drives through the Intel® ICH6R chipset. Use the Intel® Application Accelerator RAID Option ROM utility to configure a disk array.

Setting the BIOS RAID items

After installing the hard disk drives, make sure to set the necessary RAID items in the BIOS before setting your RAID configuration.

To set the BIOS RAID items:

1. Boot the system and press during the Power-On Self-Test (POST) to enter the BIOS Setup Utility.
2. From the **Main > IDE Configuration** menu in the BIOS, the **Configure SATA As** item as RAID.
3. Set the **OnBoard Serial-ATA BOOTROM** item as Enabled.
4. Save your changes and exit Setup.

Entering the Intel® Application Accelerator RAID Option ROM utility

To enter the Intel® Application Accelerator RAID option ROM utility:

1. Boot up your computer.
2. During POST, press <Ctrl+I> to display the main menu of the utility.



The RAID BIOS setup screens shown in this section are for reference only, and may not exactly match the items on your screen.

```
Intel(R) Application Accelerator RAID Option ROM v4.0.0.6211
Copyright(C) 2003-04 Intel Corporation. All Rights Reserved.

[ MAIN MENU ]

1. Create RAID Volume
2. Delete RAID Volume
3. Reset Disks to Non-RAID
4. Exit

[ DISK/VOLUME INFORMATION ]

RAID Volumes:
None defined.

Non-RAID Disks:
Port Drive Model      Serial #      Size      Type/Status (Vol ID)
0 ST380013AS          xxxxxxxx     74.5GB   Non-RAID Disk
1 ST380013AS          xxxxxxxx     74.5GB   Non-RAID Disk

[ ↓↑ ] -Select      [ ESC ] Exit      [ Enter ] -Select Menu
```

At the bottom of the screen are the navigation keys. These keys allow you to move through and select menu options.



Creating a RAID Volume

To create a RAID volume:

1. From the Intel Application Accelerator RAID Option ROM utility main menu, select **1. Create RAID Volume** then press <Enter>. The following screen appears.

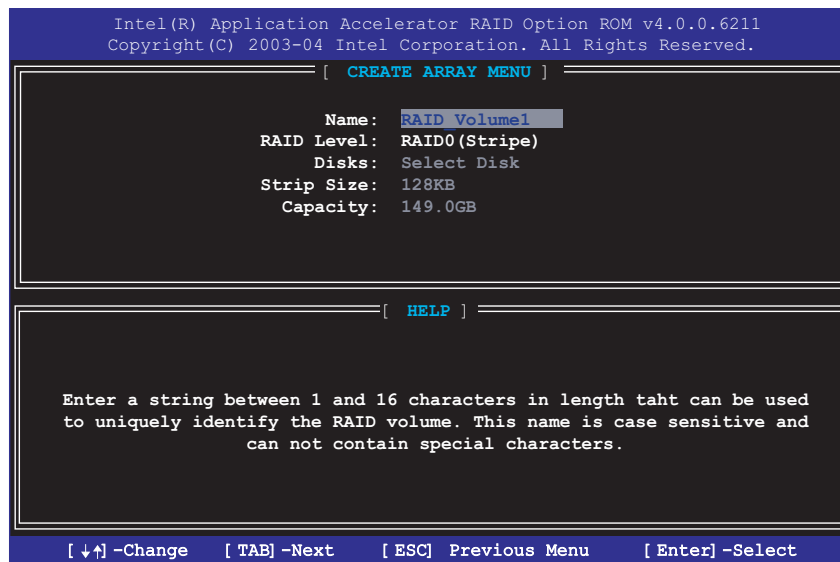

2. Key-in a unique name for your RAID volume then press <Enter>.
3. Use the up or down arrow keys to select your desired RAID Level then press <Enter>.
 - a. If you selected RAID 0 (Stripe), use the up or down arrow keys to select the stripe size for your RAID 0 array then press <Enter>. The available values range from 8 KB to 128 KB. The default selection is 128 KB. The strip value should be chosen based on the planned drive usage.
 - 8 /16 KB - low disk usage
 - 64 KB - typical disk usage
 - 128 KB - performance disk usage



TIP: For server systems, use of a lower array block size is recommended. For multimedia computer systems used mainly for audio and video editing, a higher array block size is recommended for optimum performance.

- b. If you selected RAID (Mirrored), the Create Volume prompt appears.
4. On the Create Volume prompt, press <Enter> to create the array. The utility prompts a confirmation message, press <Y>.

```
WARNING: ALL DATA ON SELECTED DISK WILL BE LOST.
Are you sure you want to create this volume (Y/N)
```

5. Select **4. Exit** then press <Enter> to exit the RAID configuration utility. The utility prompts a confirmation message, press <Y>.

Deleting a RAID Volume



Take caution in using this option. All data on the RAID drives will be lost!

To delete a RAID Volume:

1. Select the option **2. Delete RAID Volume** then press <Enter> to display the following.

```
Intel(R) Application Accelerator RAID Option ROM v4.0.0.6211
Copyright(C) 2003-04 Intel Corporation. All Rights Reserved.

[ DELETE ARRAY MENU ]

Name          Level          Drives    Capacity  Status    Bootable
RAID_Volume1  RAID0(Stripe)  2         149.0GB  Normal    Yes

[ HELP ]

Deleting a volume will destroy the volume data on the drive(s) and
cause any member disks to become available as non-RAID disks.

WARNING: EXISTING DATA WITHIN THIS VOLUME WILL BE LOST AND NON-RECOVERABLE

[ ↓↑ ] -Select    [ <ESC> ] -Previous Menu  [ <DEL> ] -Delete Volume
```

2. Press to delete the RAID volume. The following confirmation message appears.

```
[ VOLUME DELETE VERIFICATION ]

ALL DATA IN THE VOLUME WILL BE LOST!!

Are you sure you want to delete volume "RAID_Volume0"? (Y/N)
```

3. Press <Y> to confirm or <N> to return to the configuration Main Menu.

Resetting RAID Disks Drives



Take caution when resetting a RAID to non-RAID. Resetting all RAID data will remove any internal RAID structure from all RAID disks!

1. Select the option **3. Reset Disks to Non-RAID** then press <Enter>.

```
[ RESET RAID DATA ]

Resetting RAID data will remove the internal RAID structures
from the selected RAID disks. By removing these structures
the drive will revert back to a Non-RAID disk.

WARNING: Resetting a disk causes all data on the disk to be lost.

Port Drive Model      Serial #      Size      Status
0 STXXXXXXXXX        XXXXXXXX    XX.0GB    Member Disk
1 STXXXXXXXXX        XXXXXXXX    XX.0GB    Member Disk

Select the disk that should be reset

[ ↓↑ ] -Previous/Next  [ Space ] -Selects  [ Enter ] -Selection Complete
```

2. Use the up or down arrow keys to highlight a RAID drive you wish to reset then press <Space>.
3. Repeat step 2 to select other RAID drives.
4. Press <Enter> to reset RAID drive.
5. The utility prompts a confirmation message, press <Y> to confirm or <N> to return to the configuration Main Menu.

5.4.4 ITE® 8212F RAID configurations

The ITE® 8212F IDE RAID controller supports RAID 0, RAID 1, RAID 0+1 and JBOD configurations. Use the IT8212 BIOS Setup Utility or the ATA RAID Manager application to configure a disk array.

Setting the BIOS RAID items

After installing the hard disk drives, make sure to set the necessary RAID items in the BIOS before setting your RAID configuration.

To set the BIOS RAID items:

1. Boot the system and press during the Power-On Self-Test (POST) to enter the BIOS Setup Utility.
2. From the **Advanced > Onboard Devices Configuration** menu in the BIOS, set the **ITE8212F Controller** item to RAID Mode.
3. Save your changes and exit Setup.

Entering the ITE® 8212F Setup Utility

To enter the ITE® 8212F Setup Utility:

1. Boot up your computer.
2. The ITE8212F controller scans for IDE devices attached on the IDE RAID ports. When prompted, press <Ctrl+F> or <Ctrl+E> to display the main menu of the utility.

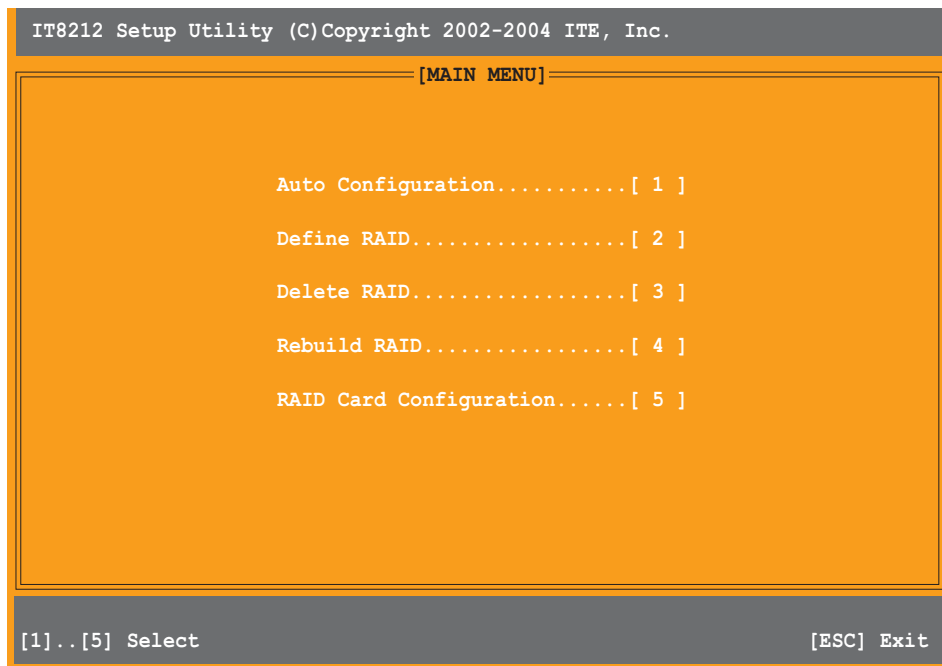

3. At the bottom of the screen are the navigation keys. These keys allow you to move through and select from the menu options.



4. Press the number of your selection or <Esc> to exit.

Auto-configuring a RAID array

This option allows you to select a supported RAID set for the utility to automatically configure.

To auto-configure a RAID set:

1. From the IT8212 Setup Utility screen, press <1>. The following screen appears.

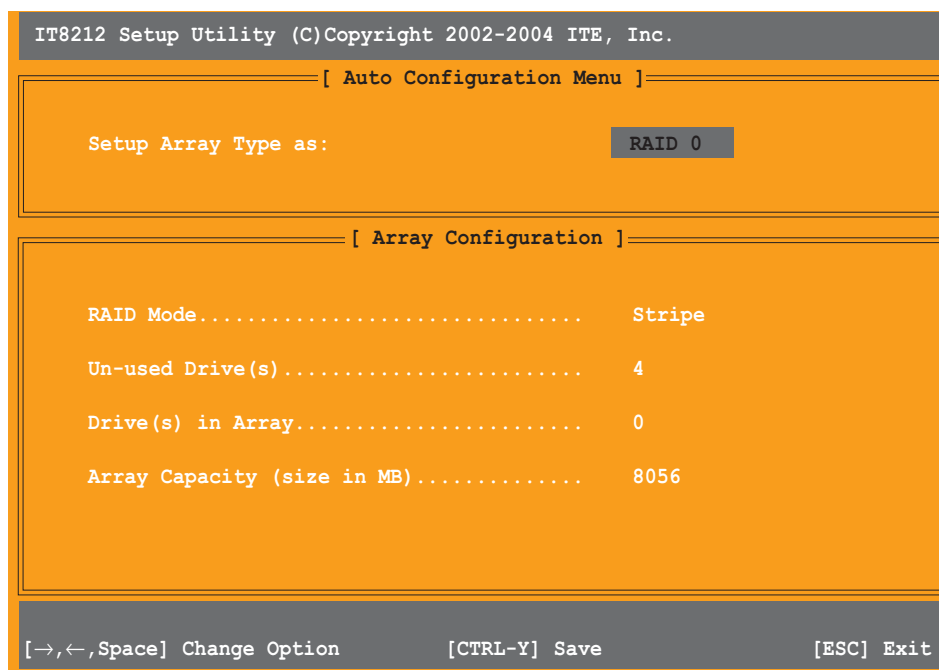

2. Use the left or right arrow keys or the space bar to select a RAID set. As you select an option, the screen displays the array configuration of the RAID based on the number of IDE devices installed.
3. Press <Ctrl+Y> to save your RAID set.
4. Press <Esc> to exit.

3. Use the up or down arrow keys to select editable fields.
4. Use the Space bar to change field values.
5. Press <Ctrl+Y> to save RAID array.
6. Press <Esc> to exit.

Deleting a RAID array

This option allows you to delete an existing RAID array.

To delete a RAID array:

1. From the IT8212 Setup Utility screen, press <3>. The following screen appears.

Array No	Array Mode	Drive No	Size (MB)	Status
Array 0	Stripe	2	XXXXXX	Functional
Array 1	Mirror	2	XXXX	Functional
Array 2	----	----	----	----
Array 3	----	----	----	----

* : Capacity (GB) ♦ : Bootable Array
 [^] Up [v] Down [D] Delete [ESC] Exit

2. Use the up or down arrow keys to select a RAID array, then press <D> to delete.
3. Press <Esc> to exit.

3. Use the up or down arrow keys to select a drive, then press <Enter>. Follow succeeding screen instructions.
4. Press <Esc> to exit.

Viewing your RAID configuration

This option allows you to view your RAID configuration. You can also enable or disable the Auto-rebuild function in this section.

To view your RAID configuration:

1. From the IT8212 Setup Utility screen, press <5>. The following screen appears.

```

IT8212 Setup Utility (C) Copyright 2002-2004 ITE, Inc.
-----[ RAID Card Configuration ]-----
Auto-Rebuild:      Enable
-----[ RAID Card Resource ]-----
Channel 0      Interrupt: B      I/P Port: 0000AC00
Channel 1      Interrupt: B      I/P Port: 0000A800
-----[ Drive Status ]-----
Channel
ID   Drive Name      Size      Array No   Drive
(MB)                               Mode
Pri/D0 XXXXXXXXXXXXXXXX XXXXXX   Array 0    U5
Pri/D1 XXXXXXXXXXXXXXXX XXXXXX   Array 0    U2
Sec/D0 XXXXXXXXXXXXXXXX XXXXXX   Array 0    U4
Sec/D1 XXXXXXXXXXXXXXXX XXXXXX   Array 0    U6
* : Capacity (GB)      Drive Mode: P = PIO, D = DMA, U = UDMA
[→,←,Space] Change Option      [ESC] Exit

```

3. Use the left or right keys or the space bar enable or disable the **Auto-rebuild** item.
4. Press <Esc> to exit.

5.5 Creating a RAID driver disk

A floppy disk with the RAID driver is required when installing Windows® 2000/XP operating system. You can create a RAID driver disk using your motherboard support CD.

To create a RAID driver disk:

1. Insert the motherboard support CD into the CD-ROM drive.
2. From the support CD Main Menu, select the **Drivers** tab.
3. Select the menu item of the RAID driver disk you wish to configure.
 - Click **Make ITE8212 Driver** to create an ITE® 8212F RAID driver disk.
 - Click **Make Silicon Image RAID5 Driver Disk** to create a Silicon Image SATAraid™ RAID driver disk



Refer to section “5.2.2 Drivers menu” for details.

4. Insert floppy disk to floppy disk drive.
5. Follow succeeding screen information to complete process.
6. Write-protect the floppy disk to avoid computer virus infection.

To install the RAID driver:

1. During the OS installation, the system prompts you to press the **F 6** key to install third-party SCSI or RAID driver.
2. Press <F6> then insert the floppy disk with RAID driver into the floppy disk drive.
3. Follow the succeeding screen instructions to complete the installation.

