

**P5S800-VM**

**ASUS**<sup>®</sup>

**Motherboard**

**E1767**

**First Edition  
October 2004**

**Copyright © 2004 ASUSTeK COMPUTER INC. All Rights Reserved.**

No part of this manual, including the products and software described in it, may be reproduced, transmitted, transcribed, stored in a retrieval system, or translated into any language in any form or by any means, except documentation kept by the purchaser for backup purposes, without the express written permission of ASUSTeK COMPUTER INC. ("ASUS").

Product warranty or service will not be extended if: (1) the product is repaired, modified or altered, unless such repair, modification or alteration is authorized in writing by ASUS; or (2) the serial number of the product is defaced or missing.

ASUS PROVIDES THIS MANUAL "AS IS" WITHOUT WARRANTY OF ANY KIND, EITHER EXPRESS OR IMPLIED, INCLUDING BUT NOT LIMITED TO THE IMPLIED WARRANTIES OR CONDITIONS OF MERCHANTABILITY OR FITNESS FOR A PARTICULAR PURPOSE. IN NO EVENT SHALL ASUS, ITS DIRECTORS, OFFICERS, EMPLOYEES OR AGENTS BE LIABLE FOR ANY INDIRECT, SPECIAL, INCIDENTAL, OR CONSEQUENTIAL DAMAGES (INCLUDING DAMAGES FOR LOSS OF PROFITS, LOSS OF BUSINESS, LOSS OF USE OR DATA, INTERRUPTION OF BUSINESS AND THE LIKE), EVEN IF ASUS HAS BEEN ADVISED OF THE POSSIBILITY OF SUCH DAMAGES ARISING FROM ANY DEFECT OR ERROR IN THIS MANUAL OR PRODUCT.

SPECIFICATIONS AND INFORMATION CONTAINED IN THIS MANUAL ARE FURNISHED FOR INFORMATIONAL USE ONLY, AND ARE SUBJECT TO CHANGE AT ANY TIME WITHOUT NOTICE, AND SHOULD NOT BE CONSTRUED AS A COMMITMENT BY ASUS. ASUS ASSUMES NO RESPONSIBILITY OR LIABILITY FOR ANY ERRORS OR INACCURACIES THAT MAY APPEAR IN THIS MANUAL, INCLUDING THE PRODUCTS AND SOFTWARE DESCRIBED IN IT.

Products and corporate names appearing in this manual may or may not be registered trademarks or copyrights of their respective companies, and are used only for identification or explanation and to the owners' benefit, without intent to infringe.

# Contents

Notices .....	vi
Safety information .....	vii
About this guide .....	viii
Typography .....	ix
P5S800-VM specifications summary .....	x

## Chapter 1: Product introduction

1.1	Welcome! .....	1-2
1.2	Package contents .....	1-2
1.3	Special features .....	1-3
	1.3.1 Product highlights .....	1-3
	1.3.2 Innovative ASUS features .....	1-4
1.4	Before you proceed .....	1-5
1.5	Motherboard overview .....	1-6
	1.5.1 Placement direction .....	1-6
	1.5.2 Screw holes .....	1-6
	1.5.3 Motherboard layout .....	1-7
1.6	Central Processing Unit (CPU) .....	1-8
	1.6.1 Installing the CPU .....	1-8
	1.6.2 Installing the CPU heatsink and fan .....	1-11
	1.6.3 Uninstalling the CPU heatsink and fan .....	1-13
1.7	System memory .....	1-15
	1.7.1 Overview .....	1-15
	1.7.2 Memory Configurations .....	1-15
	1.7.3 Installing a DIMM .....	1-17
	1.7.4 Removing a DIMM .....	1-17
1.8	Expansion slots .....	1-18
	1.8.1 Installing an expansion card .....	1-18
	1.8.2 Configuring an expansion card .....	1-18
	1.8.3 Interrupt assignments .....	1-19
	1.8.4 PCI slots .....	1-20
	1.8.5 AGP slot .....	1-20
1.9	Jumpers .....	1-21
1.10	Connectors .....	1-22
	1.10.1 Rear panel connectors .....	1-22
	1.10.2 Internal connectors .....	1-24

# Contents

## Chapter 2: BIOS setup

2.1	Managing and updating your BIOS .....	2-2
2.1.1	Creating a bootable floppy disk .....	2-2
2.1.2	ASUS EZ Flash utility .....	2-3
2.1.3	AFUDOS utility .....	2-4
2.1.4	ASUS CrashFree BIOS 2 utility .....	2-6
2.1.5	ASUS Update utility .....	2-8
2.2	BIOS setup program .....	2-11
2.2.1	BIOS menu screen .....	2-12
2.2.2	Menu bar .....	2-12
2.2.3	Navigation keys .....	2-12
2.2.4	Menu items .....	2-13
2.2.5	Sub-menu items .....	2-13
2.2.6	Configuration fields .....	2-13
2.2.7	Pop-up window .....	2-13
2.2.8	Scroll bar .....	2-13
2.2.9	General help .....	2-13
2.3	Main menu .....	2-14
2.3.1	System Time .....	2-14
2.3.2	System Date .....	2-14
2.3.3	Legacy Diskette A .....	2-14
2.3.4	Primary and Secondary IDE Master/Slave .....	2-15
2.3.5	OnChip SATA Controller .....	2-16
2.3.6	System Information .....	2-16
2.4	Advanced menu .....	2-17
2.4.1	JumperFree Configuration .....	2-17
2.4.2	CPU Configuration .....	2-19
2.4.3	Chipset .....	2-20
2.4.4	Onboard Devices Configuration .....	2-21
2.4.5	PCI PnP .....	2-23
2.4.6	USB Configuration .....	2-24
2.4.7	Instant Music Configuration .....	2-25
2.5	Power menu .....	2-26
2.5.1	Suspend Mode .....	2-26
2.5.2	ACPI 2.0 Support .....	2-26

# Contents

2.5.3	ACPI APIC Support .....	2-26
2.5.4	APM Configuration .....	2-27
2.5.5	Hardware Monitor .....	2-28
2.6	Boot menu .....	2-30
2.6.1	Boot Device Priority .....	2-30
2.6.2	Disk Drives .....	2-30
2.6.3	Boot Settings Configuration .....	2-31
2.6.4	Security .....	2-32
2.7	Exit menu .....	2-34

## Chapter 3: Software support

3.1	Installing an operating system .....	3-2
3.2	Support CD information .....	3-2
3.2.1	Running the support CD .....	3-2
3.2.2	Drivers menu .....	3-3
3.2.3	Utilities menu .....	3-4
3.2.4	ASUS Contact information .....	3-5

# Notices

## Federal Communications Commission Statement

This device complies with Part 15 of the FCC Rules. Operation is subject to the following two conditions:

- This device may not cause harmful interference, and
- This device must accept any interference received including interference that may cause undesired operation.

This equipment has been tested and found to comply with the limits for a Class B digital device, pursuant to Part 15 of the FCC Rules. These limits are designed to provide reasonable protection against harmful interference in a residential installation. This equipment generates, uses and can radiate radio frequency energy and, if not installed and used in accordance with manufacturer's instructions, may cause harmful interference to radio communications. However, there is no guarantee that interference will not occur in a particular installation. If this equipment does cause harmful interference to radio or television reception, which can be determined by turning the equipment off and on, the user is encouraged to try to correct the interference by one or more of the following measures:

- Reorient or relocate the receiving antenna.
- Increase the separation between the equipment and receiver.
- Connect the equipment to an outlet on a circuit different from that to which the receiver is connected.
- Consult the dealer or an experienced radio/TV technician for help.



---

The use of shielded cables for connection of the monitor to the graphics card is required to assure compliance with FCC regulations. Changes or modifications to this unit not expressly approved by the party responsible for compliance could void the user's authority to operate this equipment.

---

## Canadian Department of Communications Statement

This digital apparatus does not exceed the Class B limits for radio noise emissions from digital apparatus set out in the Radio Interference Regulations of the Canadian Department of Communications.

**This class B digital apparatus complies with Canadian ICES-003.**

# Safety information

## Electrical safety

- To prevent electrical shock hazard, disconnect the power cable from the electrical outlet before relocating the system.
- When adding or removing devices to or from the system, ensure that the power cables for the devices are unplugged before the signal cables are connected. If possible, disconnect all power cables from the existing system before you add a device.
- Before connecting or removing signal cables from the motherboard, ensure that all power cables are unplugged.
- Seek professional assistance before using an adapter or extension cord. These devices could interrupt the grounding circuit.
- Make sure that your power supply is set to the correct voltage in your area. If you are not sure about the voltage of the electrical outlet you are using, contact your local power company.
- If the power supply is broken, do not try to fix it by yourself. Contact a qualified service technician or your retailer.

## Operation safety

- Before installing the motherboard and adding devices on it, carefully read all the manuals that came with the package.
- Before using the product, make sure all cables are correctly connected and the power cables are not damaged. If you detect any damage, contact your dealer immediately.
- To avoid short circuits, keep paper clips, screws, and staples away from connectors, slots, sockets and circuitry.
- Avoid dust, humidity, and temperature extremes. Do not place the product in any area where it may become wet.
- Place the product on a stable surface.
- If you encounter technical problems with the product, contact a qualified service technician or your retailer.

# About this guide

This user guide contains the information you need when installing and configuring the motherboard.

## How this guide is organized

This manual contains the following parts:

- **Chapter 1: Product introduction**  
This chapter describes the features of the motherboard and the new technology it supports. This chapter also lists the hardware setup procedures that you have to perform when installing system components. It includes description of the jumpers and connectors on the motherboard.
- **Chapter 2: BIOS setup**  
This chapter tells how to change system settings through the BIOS Setup menus. Detailed descriptions of the BIOS parameters are also provided.
- **Chapter 3: Software support**  
This chapter describes the contents of the support CD that comes with the motherboard package.

## Where to find more information

Refer to the following sources for additional information and for product and software updates.

### 1. ASUS websites

The ASUS website provides updated information on ASUS hardware and software products. Refer to the ASUS contact information.

### 2. Optional documentation

Your product package may include optional documentation, such as warranty flyers, that may have been added by your dealer. These documents are not part of the standard package.



## Conventions used in this guide

To make sure that you perform certain tasks properly, take note of the following symbols used throughout this manual.



**DANGER/WARNING:** Information to prevent injury to yourself when trying to complete a task.



**CAUTION:** Information to prevent damage to the components when trying to complete a task.



**IMPORTANT:** Instructions that you **MUST** follow to complete a task.



**NOTE:** Tips and additional information to help you complete a task.

## Typography

### **Bold text**

Indicates a menu or an item to select

### *Italics*

Used to emphasize a word or a phrase

### <Key>

Keys enclosed in the less-than and greater-than sign means that you must press the enclosed key

Example: <Enter> means that you must press the Enter or Return key

### <Key1+Key2+Key3>

If you must press two or more keys simultaneously, the key names are linked with a plus sign (+)

Example: <Ctrl+Alt+D>

### **Command**

Means that you must type the command exactly as shown, then supply the required item or value enclosed in brackets

Example: At the DOS prompt, type the command line:

```
afudos /i[filename]
```

```
afudos /iP5S800VM.ROM
```

## P5S800-VM specifications summary

<b>CPU</b>	LGA775 socket for Intel® Pentium® 4/CeleronD processor Compatible with the Intel® PCG 04A and 04B processors Supports Intel® Hyper-Threading Technology
<b>Chipset</b>	Northbridge: SIS 661FX Southbridge: SIS 964
<b>Front Side Bus</b>	800/533 MHz
<b>Memory</b>	2 x 184-pin DIMM sockets support up to 2GB of unbuffered non-ECC 400/333/266 MHz DDR DIMMs
<b>Expansion slots</b>	1 x AGP 8x (1.5V only) 3 x PCI slots
<b>Storage</b>	2 x Ultra DMA 133/100/66/33 2 x Serial ATA with RAID 0 and RAID 1 configuration
<b>Audio</b>	Realtek® ALC655 6-channel CODEC S/PDIF out interface support Universal Audio Jack (UAJ®) Sensing Technology support
<b>LAN</b>	Realtek® 10/100 Mbps Ethernet controller
<b>USB</b>	Supports up to 8 USB 2.0 ports
<b>Special features</b>	Power Loss Restart ASUS AI Audio ASUS EZ Flash ASUS CrashFree BIOS 2 ASUS MyLogo2™ Instant Music Lite
<b>Rear panel</b>	1 x Parallel port 1 x LAN (RJ-45) port 4 x USB 2.0 ports 1 x VGA port 1 x Serial port (COM) 1 x PS/2 keyboard port 1 x PS/2 mouse port Audio I/O ports
<b>BIOS features</b>	4 Mb Flash ROM, AMI BIOS, PnP, WfM2.0, DMI2.0, SM BIOS 2.3, ASUS EZ Flash, CrashFree BIOS2, C.P.R. (CPU Parameter Recall)
<b>Industry standard</b>	PCI 2.2, USB 2.0
<b>Manageability</b>	WfM 2.0, DMI 2.0, WOL by PME, WOR by PME, Chassis Intrusion

*(continued on the next page)*

## P5S800-VM specifications summary

<b>Internal connectors</b>	2 x USB 2.0 connectors for 4 additional USB 2.0 ports 1 x CPU fan connector 1 x Chassis fan connector 1 x 20-pin ATX power connector 1 x 4-pin ATX 12 V power connector 1 x 3-1 pin Power LED connector 1 x 4-pin Speaker out connector 1 x CD/AUX connector 1 x Chassis intrusion connector 1 x Front panel audio connector 1 x S/PDIF out connector 1 x Front panel connector
<b>Power Requirement</b>	ATX power supply (with 20-pin and 4-pin 12 V plugs)
<b>Form Factor</b>	ATX form factor: 9.6 in x 9.6 in (24.4 cm x 24.4 cm)
<b>Support CD contents</b>	Device drivers ASUS PC Probe ASUS Live Update utility Anti-virus software (OEM version)

*\*Specifications are subject to change without notice.*



This chapter describes the motherboard features and the new technologies it supports.

# Product introduction



## 1.1 Welcome!

Thank you for buying an ASUS® P5S800-VM motherboard!

The motherboard delivers a host of new features and latest technologies, making it another standout in the long line of ASUS quality motherboards!

Before you start installing the motherboard, and hardware devices on it, check the items in your package with the list below.

## 1.2 Package contents

Check your motherboard package for the following items.

<b>Motherboard</b>	ASUS P5S800-VM motherboard
<b>Cables</b>	2 x Serial ATA signal cables 1 x Ultra DMA/133 cables 1 x Floppy disk drive cable
<b>Accessories</b>	I/O shield
<b>Application CDs</b>	ASUS motherboard support CD
<b>Documentation</b>	User guide



If any of the above items is damaged or missing, contact your retailer.

## 1.3 Special features

### 1.3.1 Product highlights

#### Latest processor technology

The motherboard comes with a 775-pin surface mount Land Grid Array (LGA) socket designed for the Intel® Pentium® 4 processor in the 775-land package. The motherboard supports the Intel® Pentium® 4 processor with 800 MHz Front Side Bus (FSB), 1 MB L2 cache, and core speed of up to 3.6 GHz. The motherboard also supports the Intel® Hyper-Threading Technology and is fully compatible with Intel® 04B and 04A processors. See page 1-8 for details.

## SIS Advanced HyperStreaming™ Architecture



The motherboard supports the SIS HyperStreaming™ technology that smartly manages data streaming between the Northbridge and Southbridge, memory, graphics interface, and other peripherals for efficient and superior performance.

## SIS Ultra-AGP™ Technology

Outstanding graphics performance is achieved with the Ultra-AGP™ technology that enables a VGA throughput of 3.2GB/s with DDR400 significantly increasing the 2.1GB/s speed provided by AGP8X.

## Serial ATA technology



The motherboard supports the Serial ATA technology through the Serial ATA interfaces and the SIS 964 chipset. The SATA specification allows for thinner, more flexible cables with lower pin count, reduced voltage requirement, and up to 150 MB/s data transfer rate. See page 1-25 for details.

## Onboard RAID solution

The onboard SIS 964 chipset allows RAID 0 or RAID 1 configuration for two SATA connectors.

## AI Audio



The motherboard comes with the Realtek® ALC655 audio CODEC that lets you enjoy high-quality 6-channel audio without having to buy advanced sound cards. It also features intelligent detection of plugged peripherals into the audio ports and identifies any incompatible devices. See page 1-23 for details.

## S/PDIF digital sound ready



The motherboard supports the S/PDIF Out function through the S/PDIF interfaces at midboard. The S/PDIF technology turns your computer into a high-end entertainment system with digital connectivity to powerful audio and speaker systems. See page 1-26 for details.

## USB 2.0 technology



The motherboard implements the Universal Serial Bus (USB) 2.0 specification, dramatically increasing the connection speed from the 12 Mbps bandwidth on USB 1.1 to a fast 480 Mbps on USB 2.0. USB 2.0 is backward compatible with USB 1.1. See page 1-28 for details.

## Temperature, fan, and voltage monitoring

The CPU temperature is monitored by the ASIC (integrated in the Winbond Super I/O) to prevent overheating and damage. The system fan rotations per minute (RPM) is monitored for timely failure detection. The ASIC monitors the voltage levels to ensure stable supply of current for critical components. See page 2-28 for details.

### 1.3.2 Innovative ASUS features

#### CrashFree BIOS 2

This feature allows you to restore the original BIOS data from the support CD in case when the BIOS codes and data are corrupted. This protection eliminates the need to buy a replacement ROM chip. See details on page 2-6.

#### ASUS MyLogo2™

This new feature present in the motherboard allows you to personalize and add style to your system with customizable boot logos. See page 2-31.

#### ASUS EZ Flash BIOS

With the ASUS EZ Flash, you can easily update the system BIOS even before loading the operating system. No need to use a DOS-based utility or boot from a floppy disk. See page 2-3 for details.

#### Instant Music Lite

This unique feature allows you to playback audio CDs even without booting the system to Windows®. Just press the ASUS Instant Music special function keys and enjoy the music! See page 2-25.



## 1.4 Before you proceed

Take note of the following precautions before you install motherboard components or change any motherboard settings.



- Unplug the power cord from the wall socket before touching any component.
- Use a grounded wrist strap or touch a safely grounded object or to a metal object, such as the power supply case, before handling components to avoid damaging them due to static electricity
- Hold components by the edges to avoid touching the ICs on them.
- Whenever you uninstall any component, place it on a grounded antistatic pad or in the bag that came with the component.
- **Before you install or remove any component, ensure that the ATX power supply is switched off or the power cord is detached from the power supply.** Failure to do so may cause severe damage to the motherboard, peripherals, and/or components.

### Onboard LED

The motherboard comes with a standby power LED that lights up to indicate that the system is ON, in sleep mode, or in soft-off mode. This is a reminder that you should shut down the system and unplug the power cable before removing or plugging in any motherboard component. The illustration below shows the location of the onboard LED.

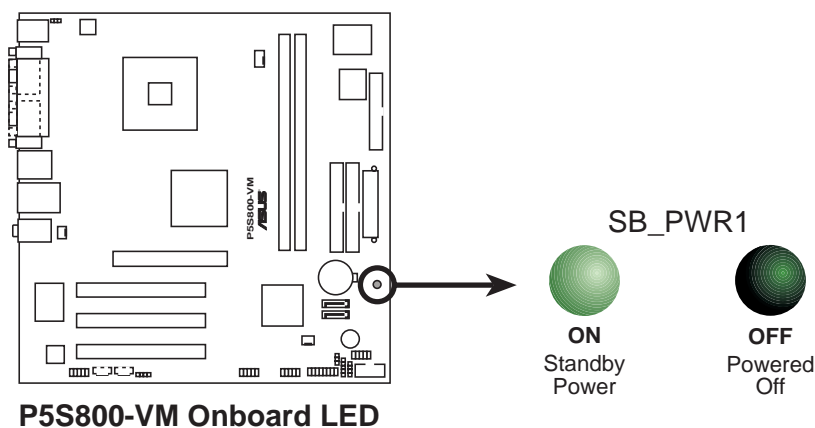

## 1.5 Motherboard overview

Before you install the motherboard, study the configuration of your chassis to ensure that the motherboard fits into it.



Make sure to unplug the power cord before installing or removing the motherboard. Failure to do so can cause you physical injury and damage motherboard components.

### 1.5.1 Placement direction

When installing the motherboard, make sure that you place it into the chassis in the correct orientation. The edge with external ports goes to the rear part of the chassis as indicated in the image below.

### 1.5.2 Screw holes

Place eight (8) screws into the holes indicated by circles to secure the motherboard to the chassis.



Do not overtighten the screws! Doing so can damage the motherboard.

Place this side towards  
the rear of the chassis

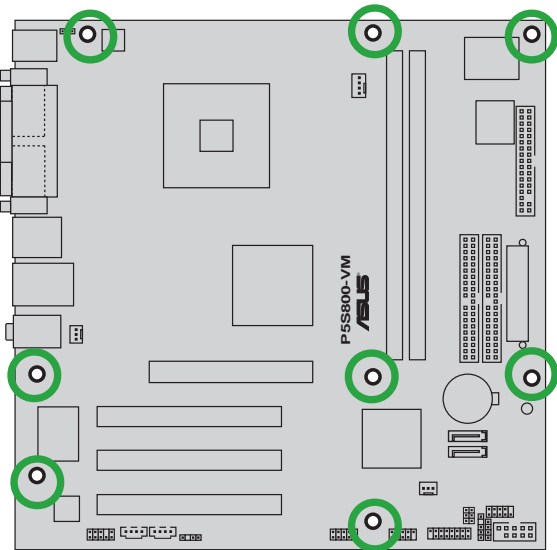

### 1.5.3 Motherboard layout

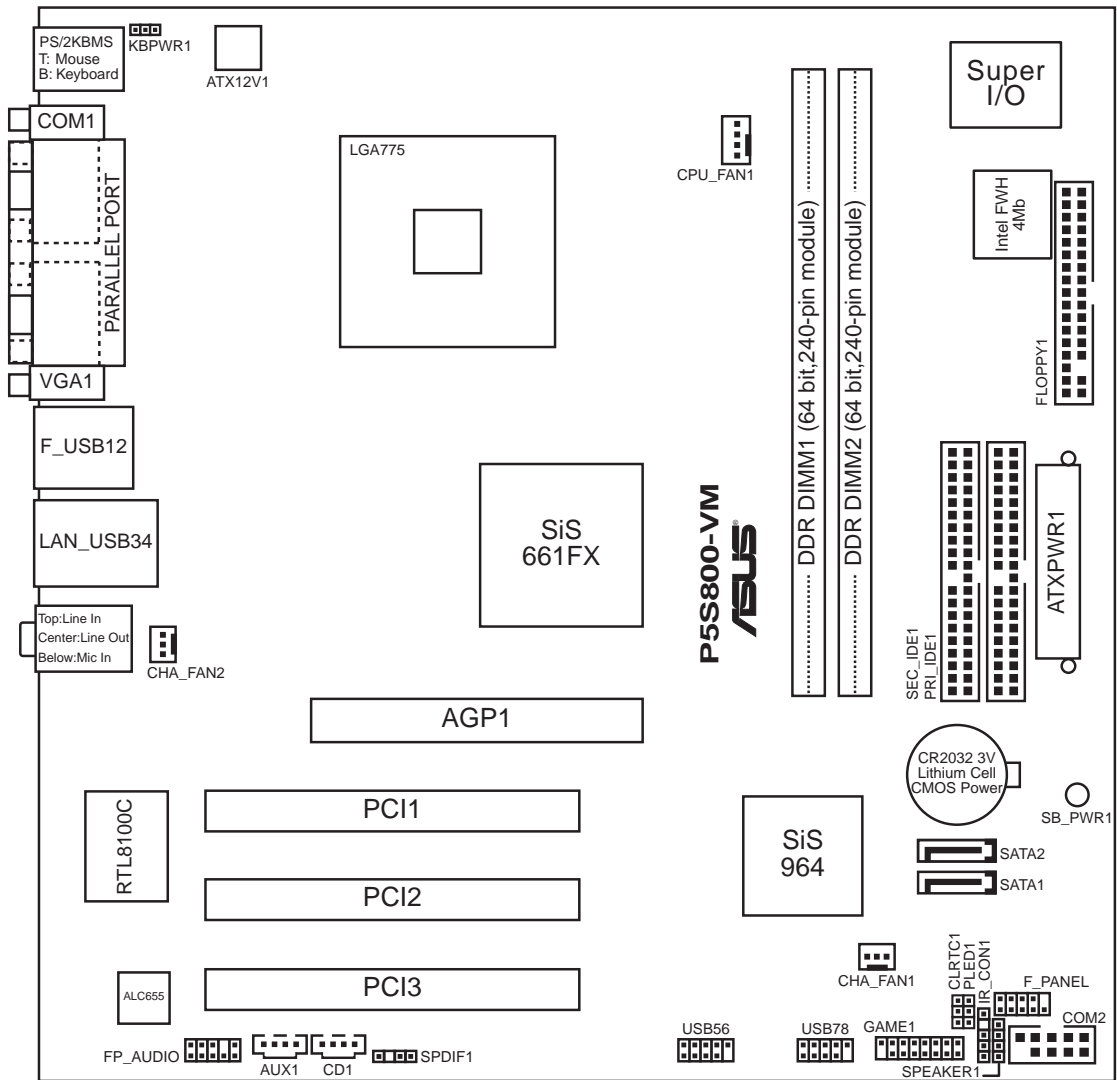

## 1.6 Central Processing Unit (CPU)

The motherboard comes with a surface mount LGA775 socket designed for the Intel® Pentium® 4 processor in the 775-land package.



- Your boxed Intel® Pentium® 4 LGA775 processor package should come with installation instructions for the CPU, fan and heatsink assembly. If the instructions in this section do not match the CPU documentation, follow the latter.
- Upon purchase of the motherboard, make sure that the PnP cap is on the socket and the socket pins are not bent. Contact your retailer immediately if the PnP cap is missing, or if you see any damage to the PnP cap/socket pins/motherboard components. ASUS will shoulder the cost of repair only if the damage is shipment/transit-related.
- Keep the cap after installing the motherboard. ASUS will process Return Merchandise Authorization (RMA) requests only if the motherboard comes with the cap on the LGA775 socket.
- The product warranty does not cover damage to the socket pins resulting from incorrect CPU installation/removal, or misplacement/loss/incorrect removal of the PnP cap.

### 1.6.1 Installing the CPU

To install a CPU:

1. Locate the CPU socket on the motherboard.

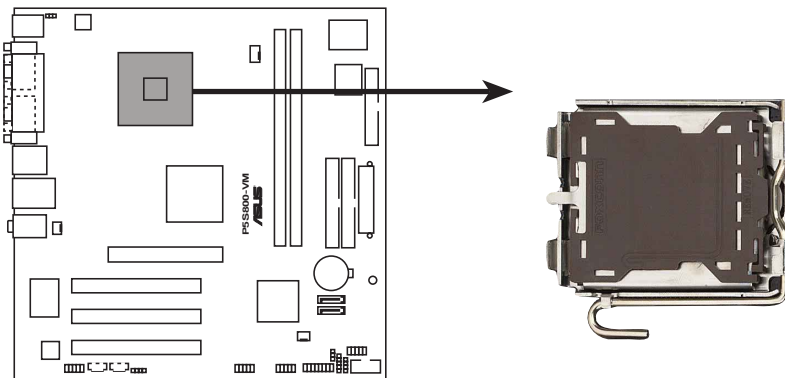

**P5S800-VM CPU Socket 775**



Before installing the CPU, make sure that the socket box is facing towards you and the load lever is on your left.

2. Press the load lever with your thumb (A) and move it to the left (B) until it is released from the retention tab.

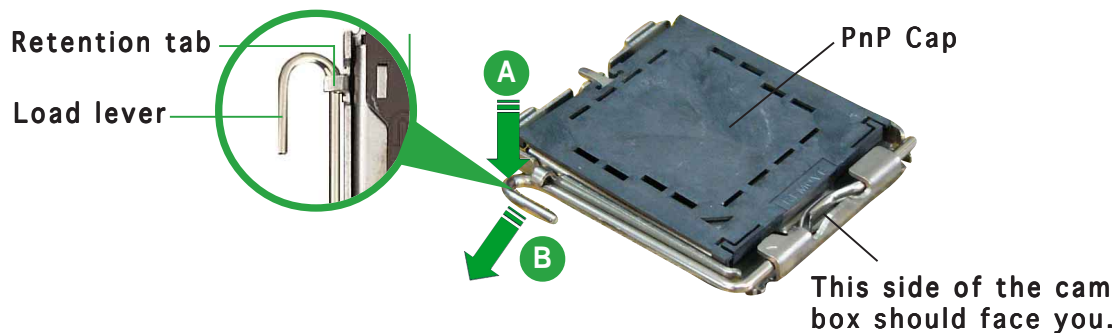

To prevent damage to the socket pins, do not remove the PnP cap unless you are installing a CPU.

3. Lift the load lever in the direction of the arrow to a 135° angle.

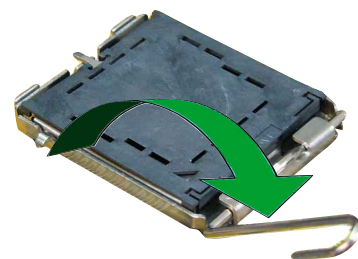

4. Lift the load plate with your thumb and forefinger to a 100° angle (A), then push the PnP cap from the load plate window to remove (B).

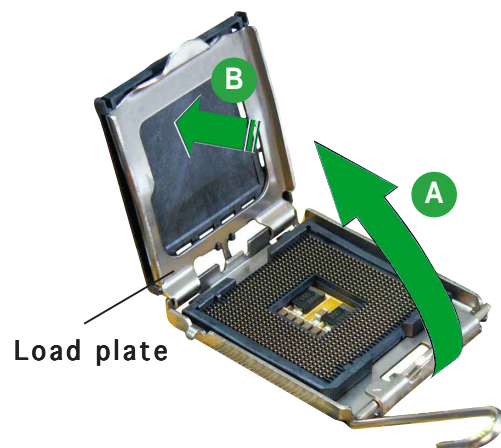

5. Position the CPU over the socket, making sure that the gold triangle is on the bottom-left corner of the socket. The socket alignment key should fit into the CPU notch.

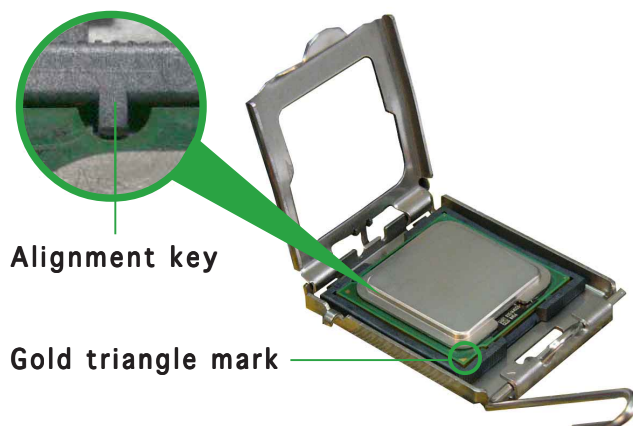

6. Close the load plate (A), then push the load lever (B) until it snaps into the retention tab.

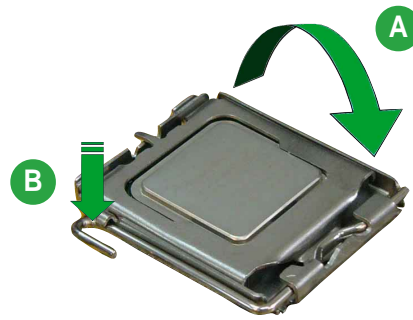

---

The CPU fits in only one correct orientation. DO NOT force the CPU into the socket to prevent bending the connectors on the socket and damaging the CPU!

---

## Notes on Intel® Hyper-Threading Technology



- This motherboard supports Intel® Pentium® 4 CPUs in the 775-land package with Hyper-Threading Technology.
  - Hyper-Threading Technology is supported under Windows® XP/2003 Server and Linux 1.7.x (kernel) and later versions only. Under Linux, use the Hyper-Threading compiler to compile the code. If you are using any other operating systems, disable the Hyper-Threading Technology item in the BIOS to ensure system stability and performance.
  - Installing Windows® XP Service Pack 1 or later is recommended.
  - Make sure to enable the Hyper-Threading Technology item in BIOS before installing a supported operating system.
  - For more information on Hyper-Threading Technology, visit [www.intel.com/info/hyperthreading](http://www.intel.com/info/hyperthreading).
- 

To use the Hyper-Threading Technology on this motherboard:

1. Install an Intel® Pentium® 4 CPU in the 775-land package that supports Hyper-Threading Technology.
2. Power up the system and enter the BIOS Setup (see Chapter 2: BIOS setup). Under the Advanced Menu, make sure that the item Hyper-Threading Technology is set to Enabled. The item appears only if you installed a CPU that supports Hyper-Threading Technology.
3. Reboot the computer.

## 1.6.2 Installing the CPU heatsink and fan

The Intel® Pentium® 4 LGA775 processor requires a specially designed heatsink and fan assembly to ensure optimum thermal condition and performance.



- Install the motherboard to the chassis before you install the CPU fan and heatsink assembly
- When you buy a boxed Intel® Pentium® 4 processor, the package includes the CPU fan and heatsink assembly. If you buy a CPU separately, make sure that you use only Intel®-certified multi-directional heatsink and fan.
- Your Intel® Pentium® 4 LGA775 heatsink and fan assembly comes in a push-pin design and requires no tool to install.



If you purchased a separate CPU heatsink and fan assembly, make sure that a Thermal Interface Material is properly applied to the CPU heatsink or CPU before you install the heatsink and fan assembly.

To install the CPU heatsink and fan:

1. Place the heatsink on top of the installed CPU, making sure that the four fasteners match the holes on the motherboard.

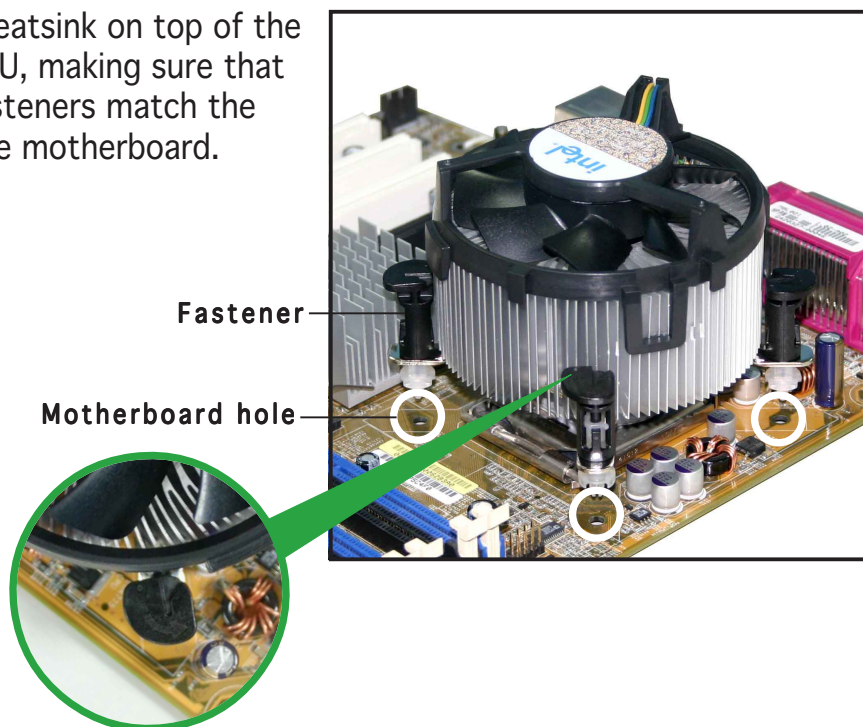

Make sure each fastener is oriented as shown, with the narrow groove directed outward.

2. Push down two fasteners at a time in a diagonal sequence to secure the heatsink and fan assembly in place.

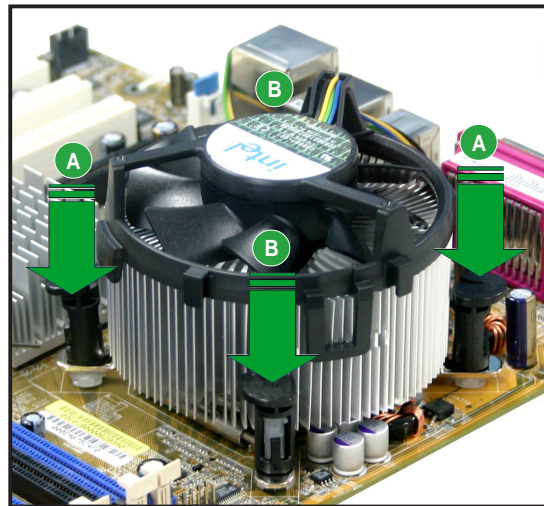
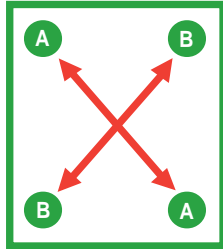

3. When the fan and heatsink assembly is in place, connect the CPU fan cable to the connector on the motherboard labeled CPU\_FAN1.

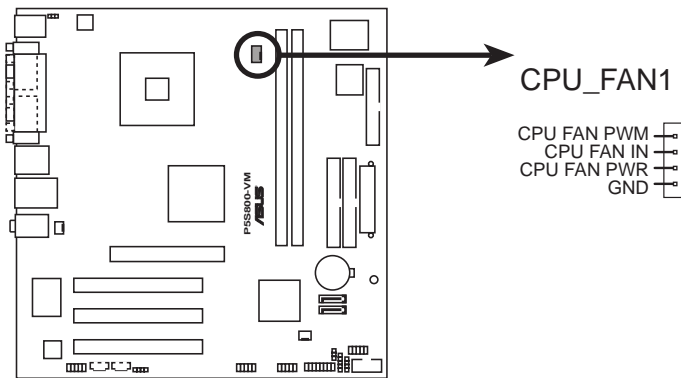

**P5S800-VM CPU FAN connector**



Do not forget to connect the CPU fan connector! Hardware monitoring errors can occur if you fail to plug this connector.



### 1.6.3 Uninstalling the CPU heatsink and fan

To uninstall the CPU heatsink and fan:

1. Disconnect the CPU fan cable from the connector on the motherboard labeled CPU\_FAN1.
2. Rotate each fastener counterclockwise.

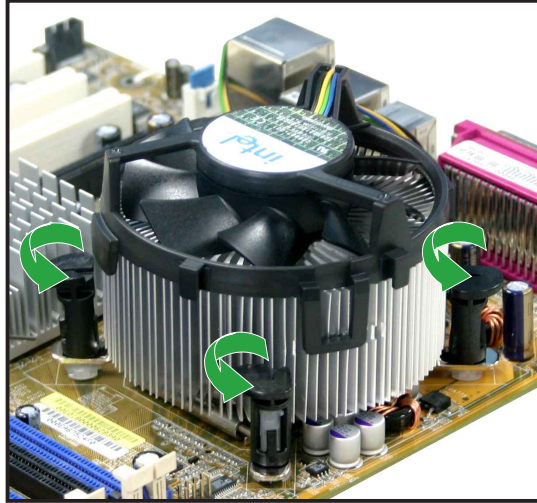

3. Pull up two fasteners at a time in a diagonal sequence to disengage the heatsink and fan assembly from the motherboard.

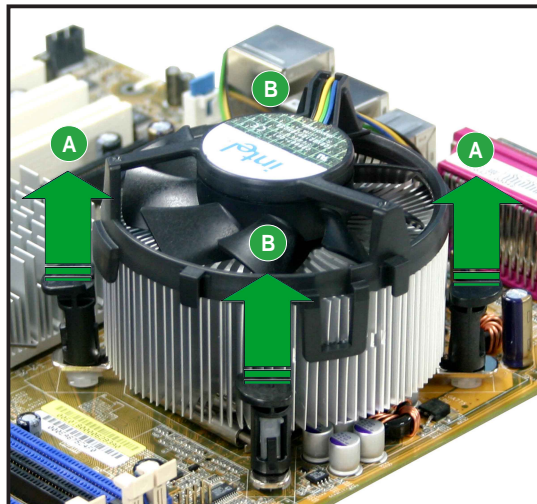
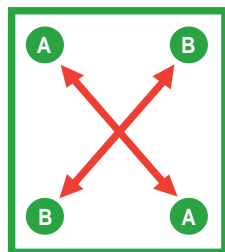

4. Remove the heatsink and fan assembly from the motherboard.

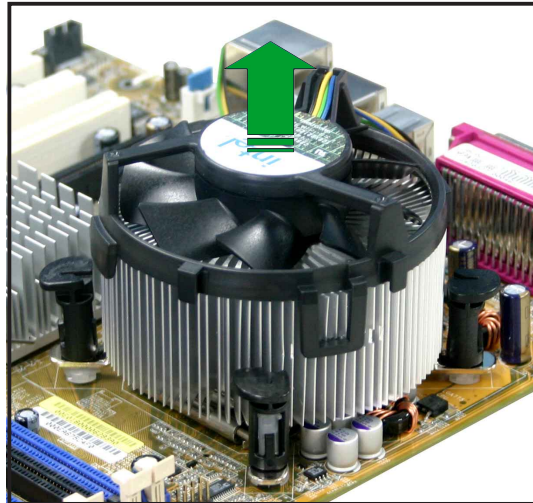

5. Rotate each fastener clockwise to reset the orientation.

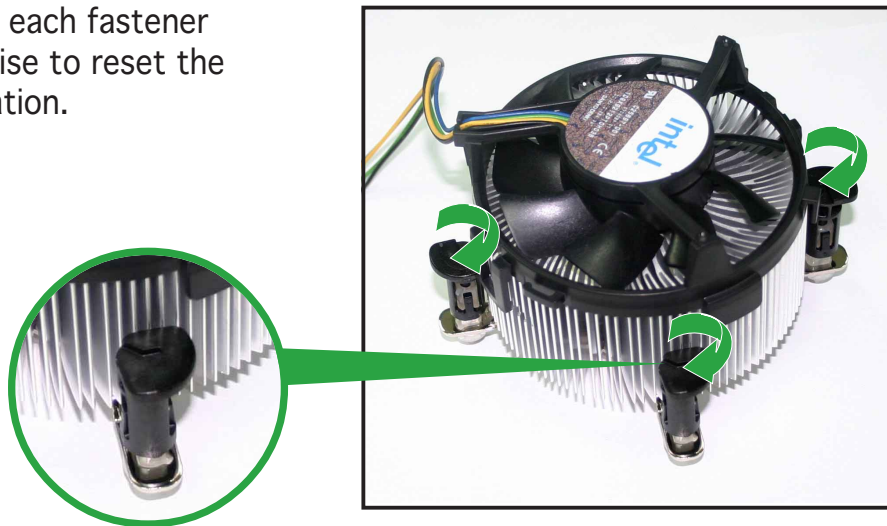

Narrow end of the groove



The narrow end of the groove should point outward after resetting. (The photo shows the groove shaded for emphasis.)

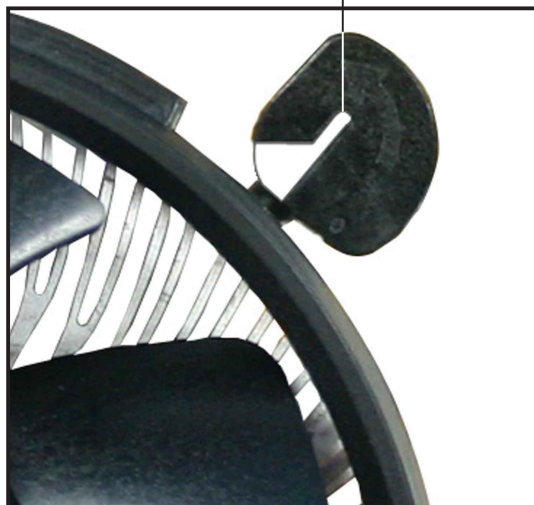

## 1.7 System memory

### 1.7.1 Overview

The motherboard comes with four 184-pin Double Data Rate (DDR) Dual Inline Memory Modules (DIMM) sockets.

The following figure illustrates the location of the sockets:

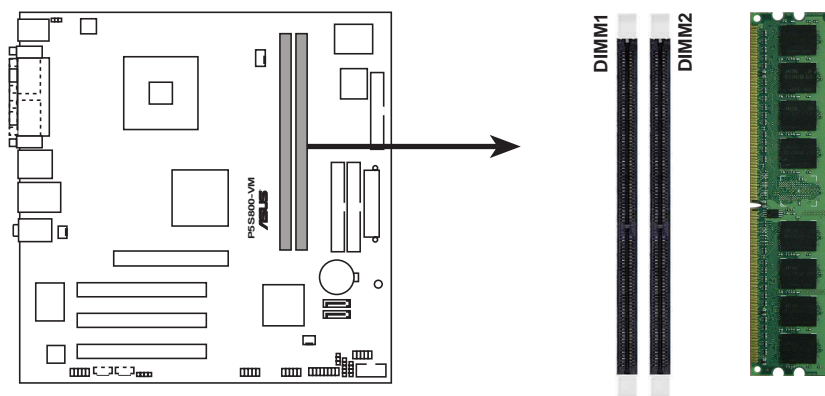

P5S800-VM 184-pin DDR DIMM sockets

### 1.7.2 Memory Configurations

You may install 128 MB, 256 MB, 512 MB and 1 GB unbuffered non-ECC DDR DIMMs into the DIMM sockets using the memory configurations in this section.



---

Installing DDR DIMMs other than the recommended configurations may cause memory sizing error or system boot failure. Use any of the recommended configurations in Table 1.

---

**Table 1 DDR Qualified Vendors List**

Size	Vendor	Model	Brand	Side(s)	Component	DIMM support	
						A	B
256MB	Kingston	KVR333X64C25/256	Kingston	SS	D3208DH1T-6	•	•
257MB	Kingston	KVR333X64C25/256	Hynix	SS	HY5DU56822BT-J	•	•
512MB	Kingston	KVR333X64C25/512	Hynix	DS	HY5DU56822BT-D43	•	•
512MB	Kingston	KVR333X64C25/512	Hynix	DS	HY5DU56822BT-J	•	•
512MB	Kingston	KVR400X643A/512	Hynix	DS	HY5DU56822BT-D43	•	•
512MB	Kingston	KVR400X64C3A/512	Kingston	DS	D3208DL3T-5	•	•
256MB	Kingston	KVR400X64C3A/256	Hynix	SS	HY5DU56822BT-D43	•	•
256MB	Infineon	HYS64D64320GU-5-C	Infineon	SS	HYB25D256800CE-5C	•	•
512MB	Infineon	HYS64D32300GU-5-C	Infineon	DS	HYB25D256800CE-5C	•	•
256MB	Infineon	HYS64D64320GU-5-C	Infineon	SS	HYB25D256800CE-5C	•	•
512MB	Infineon	HYS64D64320GU-6-C	Infineon	DS	HYB25D256800CE-6C	•	•
512MB	HY	DDR400-512	Hynix	DS	HY5DU56822BT-D43	•	•
256MB	HY	DDR266-256	Hynix	SS	HY5DU56822AT-H	•	•
256MB	HY	DDR333-256	Hynix	SS	HY5DU56822BT-J	•	•
512MB	HY	DDR333-512	Hynix	DS	HY5DU56822BT-J	•	•
256MB	Corsair	VS256MB400	Value select	SS	VS32M8-5 2B0409	•	•
512MB	Corsair	VS512MB400	Value select	DS	VS32M8-5 2B0412	•	•
256MB	Corsair	VS256MB333	Samsung	SS	K4H5608380-TCB3	•	•
512MB	Micron	MT16VDDT6464AG-335GB	Micron	DS	MT46V32M8-G	•	•
256MB	Micron	MT8VDDT3264AG-335GB	Micron	SS	MT46V32M8-G	•	•
256MB	Micron	MT8VDDT3264AG-40BGB	Micron	SS	MT46V32M8-G	•	•
256MB	Samsung	M368L3223FTN-CB3	Samsung	SS	K4H560838F-TCB3	•	•
512MB	Samsung	M368L6423FTN-CB3	Samsung	DS	K4H5608838F-TCB3	•	•
256MB	Winbond	U24256ADWBG6H20	Winbond	SS	W942508CH-5	•	•
256MB	Winbond	U24256AAWBG6H20	Winbond	SS	W942508CH-6	•	•
512MB	Winbond	DDR333-512	Winbond	DS	W942508BH-6	•	•
256MB	Transcend	DDR400-256	Mosel	SS	V58C2256804SAT5B	•	•
512MB	Transcend	DDR400-512	Samsung	DS	K4H560838F-TCCC	•	•
256MB	Transcend	DDR333-256	Mosel	SS	V58C2256804SAT6	•	•
512MB	Transcend	DDR333-512	Hynix	DS	HY5DU56822CT-J	•	•
512MB	Kingmax	MPXC22D-38KT3R	Kingmax	DS	KDL388P4EA-50	•	•
256MB	Apacer	77.10628.10A	Apacer	SS	AM3A5608AIT-6B	•	•
512MB	Apacer	77.90739.U1G	Apacer	DS	AM3A568AJT-5A	•	•
256MB	Apacer	77.10628.56G	Mosel	SS	V58C2256804SAT6	•	•
256MB	Apacer	77.10636.56G	Mosel	SS	V58C2256804SAT5B	•	•
512MB	Apacer	77.10736.11G	Infineon	DS	HYB25D256800BT-5B	•	•
512MB	Smart	U24512ADSRG6H20	Smart	DS	D32M8XS50H3X4AMV	•	•
1G	Twinmos	M2S5016AJAMC5G0811A-J	Micron	DS	MT46V64M8TG-6T	•	•
	Twinmos	M2S9109BFAPS9F0811A-T	PSC	SS	A2S56D30ATP	•	•

**Legend:**

- A** - supports one module inserted into either slot, in a Single-channel memory configuration.
- B** - supports one pair of modules inserted into both slots.
- SS** - Single-sided
- DS** - Double-sided

### 1.7.3 Installing a DIMM



Make sure to unplug the power supply before adding or removing DIMMs or other system components. Failure to do so may cause severe damage to both the motherboard and the components.

1. Unlock a DIMM socket by pressing the retaining clips outward.
2. Align a DIMM on the socket such that the notch on the DIMM matches the break on the socket.

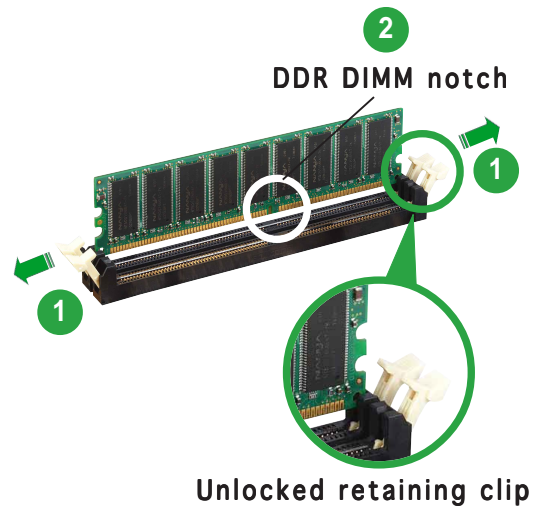

A DDR DIMM is keyed with a notch so that it fits in only one direction. DO NOT force a DIMM into a socket to avoid damaging the DIMM.

3. Firmly insert the DIMM into the socket until the retaining clips snap back in place and the DIMM is properly seated.

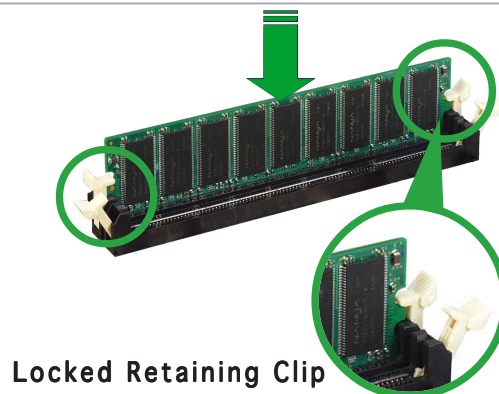

### 1.7.4 Removing a DIMM

Follow these steps to remove a DIMM.

1. Simultaneously press the retaining clips outward to unlock the DIMM.

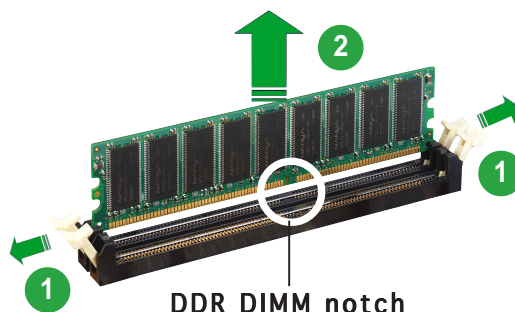

Support the DIMM lightly with your fingers when pressing the retaining clips. The DIMM might get damaged when it flips out with extra force.

2. Remove the DIMM from the socket.

## 1.8 Expansion slots

In the future, you may need to install expansion cards. The following sub-sections describe the slots and the expansion cards that they support.



---

Make sure to unplug the power cord before adding or removing expansion cards. Failure to do so may cause you physical injury and damage motherboard components.

---

### 1.8.1 Installing an expansion card

To install an expansion card:

1. Before installing the expansion card, read the documentation that came with it and make the necessary hardware settings for the card.
2. Remove the system unit cover (if your motherboard is already installed in a chassis).
3. Remove the bracket opposite the slot that you intend to use. Keep the screw for later use.
4. Align the card connector with the slot and press firmly until the card is completely seated on the slot.
5. Secure the card to the chassis with the screw you removed earlier.
6. Replace the system cover.

### 1.8.2 Configuring an expansion card

After installing the expansion card, configure it by adjusting the software settings.

1. Turn on the system and change the necessary BIOS settings, if any. See Chapter 2 for information on BIOS setup.
2. Assign an IRQ to the card. Refer to the tables on the next page.
3. Install the software drivers for the expansion card.



## 1.8.3 Interrupt assignments

### Standard interrupt assignments

IRQ	Priority	Standard Function
0	1	System Timer
1	2	Keyboard Controller
2	•	Re-direct to IRQ#9
3	11	Communications Port (COM2)*
4	12	Communications Port (COM1)*
5	13	IRQ holder for PCI steering*
6	14	Floppy Disk Controller
7	15	Printer Port (LPT1)*
8	3	System CMOS/Real Time Clock
9	4	IRQ holder for PCI steering*
10	5	IRQ holder for PCI steering*
11	6	IRQ holder for PCI steering*
12	7	PS/2 Compatible Mouse Port*
13	8	Numeric Data Processor
14	9	Primary IDE Channel
15	10	Secondary IDE Channel

\* These IRQs are usually available for ISA or PCI devices.

### IRQ assignments for this motherboard

	A	B	C	D	E	F	G	H
PCI slot 1	—	—	—	—	—	—	used	—
PCI slot 2	—	shared	—	—	—	—	—	—
PCI slot 3	—	—	—	—	—	used	—	—
AGP 8X slot	shared	—	—	—	—	—	—	—
Onboard USB controller 1	—	—	—	—	—	—	—	shared
Onboard USB controller 2	—	—	—	used	—	—	—	—
Onboard USB controller 3	—	—	used	—	—	—	—	—
Onboard USB controller 4	shared	—	—	—	—	—	—	—
Onboard USB 2.0 controller	—	—	—	—	—	—	—	shared
Onboard LAN	—	shared	—	—	—	—	—	—
Onboard audio	shared	—	—	—	—	—	—	—
Onboard VGA	shared	—	—	—	—	—	—	—



When using PCI cards on shared slots, ensure that the drivers support “Share IRQ” or that the cards do not need IRQ assignments. Otherwise, conflicts will arise between the two PCI groups, making the system unstable and the card inoperable.

## 1.8.4 PCI slots

The PCI slots support cards such as a LAN card, SCSI card, USB card, and other cards that comply with PCI specifications. The figure shows a LAN card installed on a PCI slot.

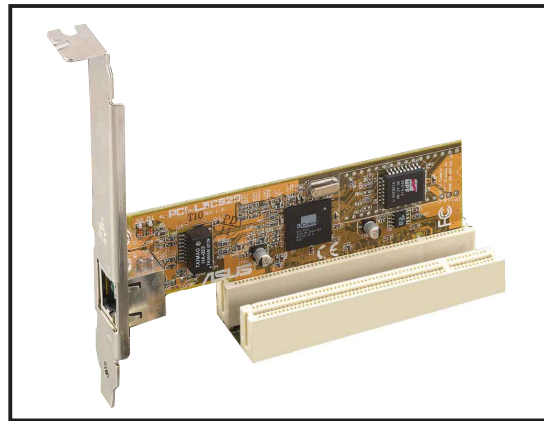

## 1.8.5 AGP slot

The Accelerated Graphics Port (AGP) slot supports AGP8X/4X cards. When you buy an AGP card, make sure that you ask for one with +1.5V specification. Note the notches on the card golden fingers to ensure that they fit the AGP slot on your motherboard.



Install only 1.5 V or 0.8 V AGP cards on this motherboard! 3.3V AGP cards are not supported in this motherboard.

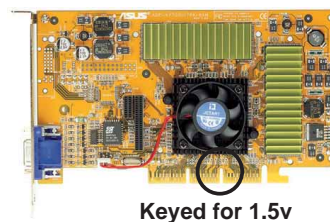
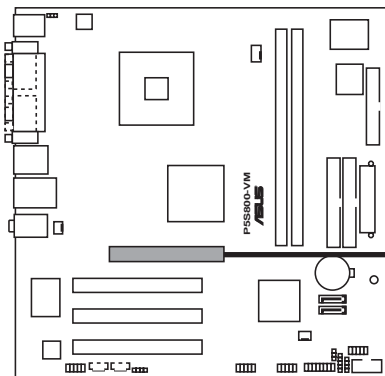

Keyed for 1.5v

**P5S800-VM Accelerated Graphics Port (AGP)**



## 1.9 Jumpers

### 1. Clear RTC RAM (CLRTC1)

This jumper allows you to clear the Real Time Clock (RTC) RAM in CMOS. You can clear the CMOS memory of date, time, and system setup parameters by erasing the CMOS RTC RAM data. The onboard button cell battery powers the RAM data in CMOS, which include system setup information such as system passwords.

To erase the RTC RAM:

1. Turn OFF the computer and unplug the power cord.
2. Remove the onboard battery.
3. Move the jumper cap from pins 2-3 (default) to pins 1-2. Keep the cap on pins 1-2 for about 5~10 seconds, then move the cap back to pins 2-3.
4. Re-install the battery.
5. Plug the power cord and turn ON the computer.
6. Hold down the <Del> key during the boot process and enter BIOS setup to re-enter data.



---

Except when clearing the RTC RAM, never remove the cap on CLRTC jumper default position. Removing the cap will cause system boot failure!

---

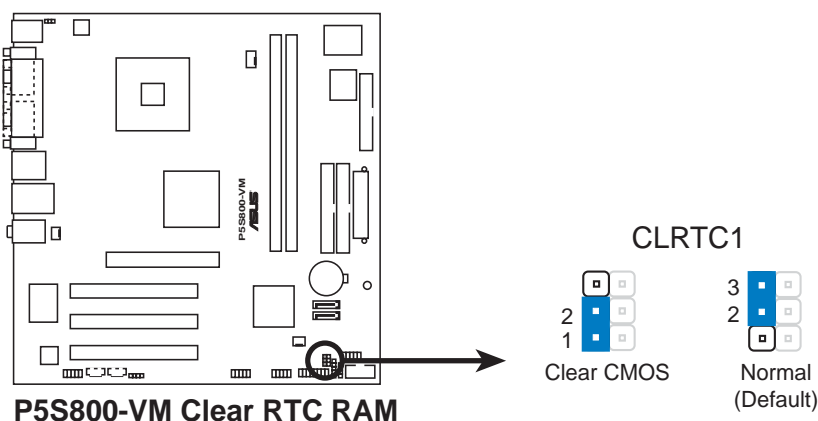

---

You do not need to clear the RTC when the system hangs due to overclocking. For system failure due to overclocking, use the C.P.R. (CPU Parameter Recall) feature. Shut down and reboot the system so the BIOS can automatically reset parameter settings to default values.

---

## 2. Keyboard power (3-pin KBPWR1)

This jumper allows you to enable or disable the keyboard wake-up feature. Set this jumper to pins 2-3 (+5VSB) to wake up the computer when you press a key on the keyboard (the default is the Space Bar). This feature requires an ATX power supply that can supply at least 1A on the +5VSB lead, and a corresponding setting in the BIOS.

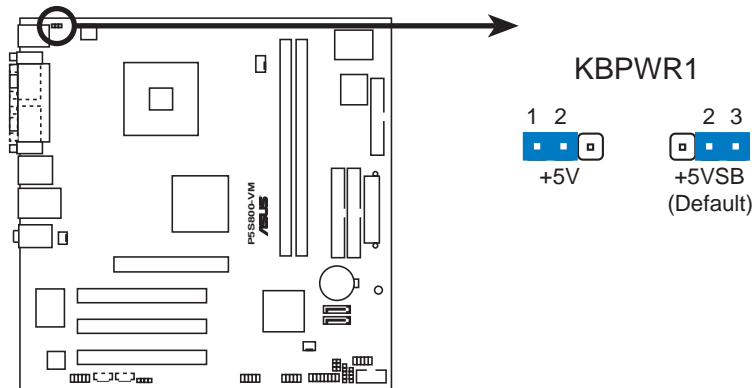

P5S800-VM Keyboard power setting

## 1.10 Connectors

### 1.10.1 Rear panel connectors

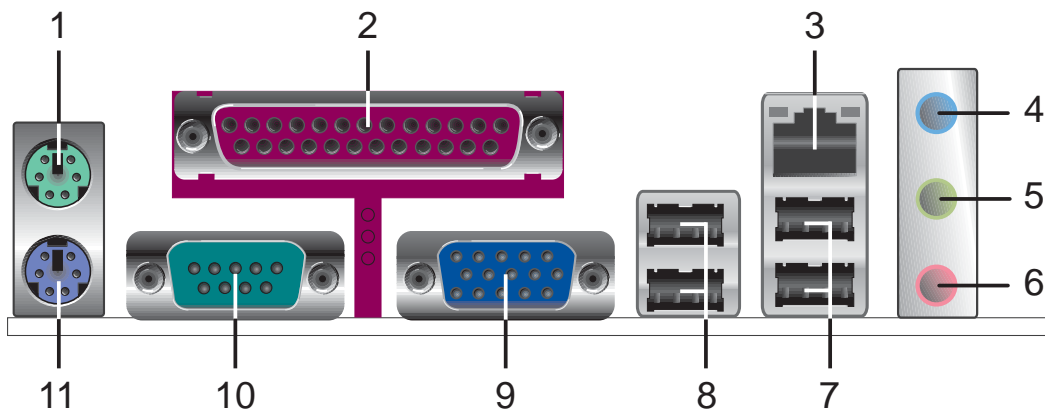

1. **PS/2 mouse port (green).** This port is for a PS/2 mouse.
2. **Parallel port.** This 25-pin port connects a parallel printer, a scanner, or other devices.
3. **LAN (RJ-45) port.** This port allows Gigabit connection to a Local Area Network (LAN) through a network hub. Refer to the table below for the LAN port LED indications.

## LAN port LED indications

ACT/LINK LED		SPEED LED	
Status	Description	Status	Description
OFF	No link	OFF	10 Mbps connection
GREEN	Linked	ORANGE	100 Mbps connection
BLINKING	Data activity		

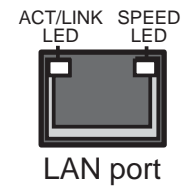

- Line In port (light blue).** This port connects a tape, CD, DVD player, or other audio sources. In 4-channel and 6-channel configuration, the function of this port becomes Front Speaker Out.
- Line Out port (lime).** This port connects a headphone or a speaker. In 4-channel and 6-channel configuration, the function of this port becomes Rear Speaker Out.
- Microphone port (pink).** This port connects a microphone. In a 6-channel configuration, the function of this port becomes Center/Subwoofer.



Refer to the audio configuration table for the function of the audio ports in 2, 4, or 6-channel configuration.

## Audio 2, 4, or 6-channel configuration

Port	Headset 2-channel	4-channel	6-channel
Light Blue	Line In	Front Speaker Out	Front Speaker Out
Lime	Line Out	Rear Speaker Out	Rear Speaker Out
Pink	Mic In	Mic In	Center/Subwoofer

- USB 2.0 ports 3 and 4.** These two 4-pin Universal Serial Bus (USB) ports are available for connecting USB 2.0 devices.
- USB 2.0 ports 1 and 2.** These two 4-pin Universal Serial Bus (USB) ports are available for connecting USB 2.0 devices.
- VGA port.** This 15-pin VGA port connects to a VGA monitor.
- Serial connector.** This 9-pin COM1 port is for serial devices.
- PS/2 keyboard port (purple).** This port is for a PS/2 keyboard.

## 1.10.2 Internal connectors

### 1. Floppy disk drive connector (34-1 pin FLOPPY1)

This connector is for the provided floppy disk drive (FDD) signal cable. Insert one end of the cable to this connector, then connect the other end to the signal connector at the back of the floppy disk drive.



Pin 5 on the connector is removed to prevent incorrect cable connection when using an FDD cable with a covered Pin 5.

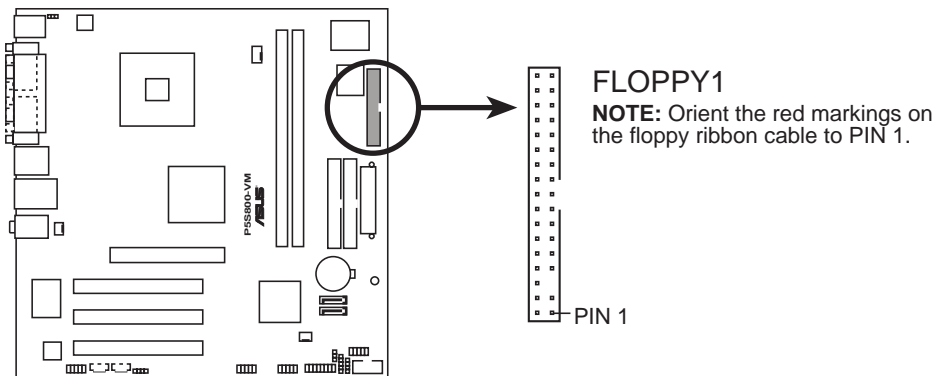

**P5S800-VM Floppy disk drive connector**

### 2. Primary IDE connector (40-1 pin PRI\_IDE1, SEC\_IDE1)

These connectors are for Ultra DMA 100/66 signal cables. The Ultra DMA 100/66 signal cable has three connectors: a blue connector for the primary IDE connector on the motherboard, a black connector for an Ultra DMA 100/66 IDE slave device (optical drive/hard disk drive), and a gray connector for an Ultra DMA 100/66 IDE master device (hard disk drive). If you install two hard disk drives, you must configure the second drive as a slave device by setting its jumper accordingly. Refer to the hard disk documentation for the jumper settings.



- Pin 20 on the IDE connector is removed to match the covered hole on the Ultra DMA cable connector. This prevents incorrect insertion when you connect the IDE cable.
- Use the 80-conductor IDE cable for Ultra DMA 100/66 IDE devices.

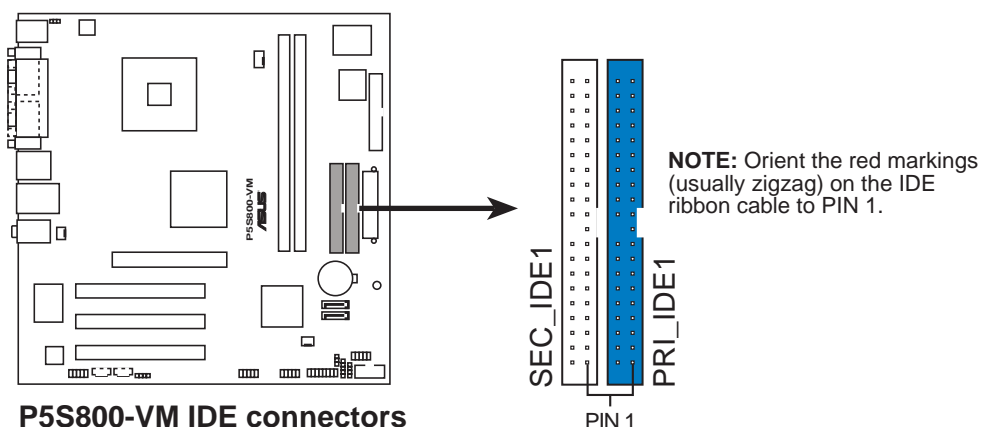

**P5S800-VM IDE connectors**

### 3. Serial ATA connectors (7-pin SATA1, SATA2)

These connectors are for the Serial ATA signal cables for Serial ATA hard disk drives.

If you installed Serial ATA hard disk drives, you can create a RAID 0 or RAID 1 configuration through the onboard SIS 964 RAID controller.

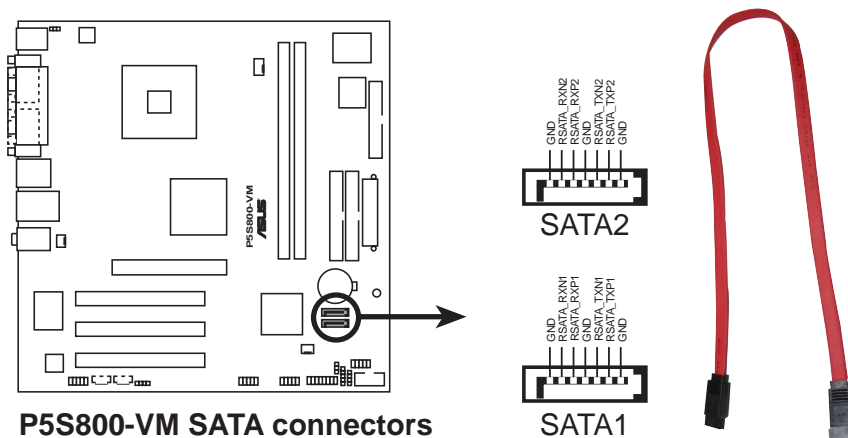

#### Important notes on Serial ATA

- The Serial ATA RAID feature (RAID 0, RAID 1) is available only if you are using Windows® 2000/XP.
- Install the Windows® 2000 Service Pack 4 or the Windows® XP Service Pack 1 or later before using Serial ATA.

### 4. Speaker connector (4-pin SPEAKER1)

This 4-pin connector is for the chassis-mounted system warning speaker. The speaker allows you to hear system beeps and warnings.

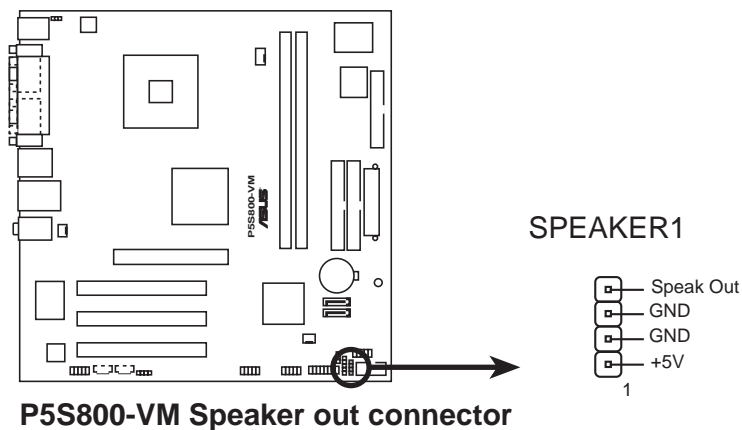

## 5. CPU and Chassis fan connectors (4-pin CPU\_FAN1, 3-pin CHA\_FAN1, 3-pin CHA\_FAN2)

The fan connectors support cooling fans of 350mA~740mA (8.88W max.) or a total of 1A~2.22A (26.64W max.) at +12V. Connect the fan cables to the fan connectors on the motherboard, making sure that the black wire of each cable matches the ground pin of the connector.



Do not forget to connect the fan cables to the fan connectors. Insufficient air flow inside the system may damage the motherboard components. These are not jumpers! DO NOT place jumper caps on the fan connectors.

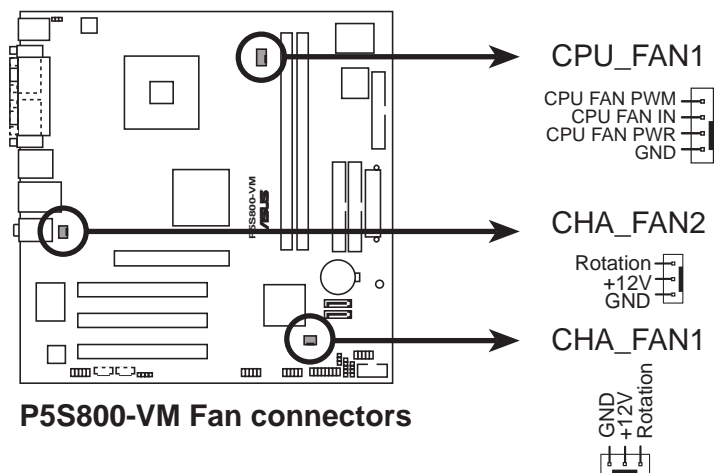

## 6. Digital Audio connector (4-1 pin SPDIF1)

This connector is for the S/PDIF audio module to allow digital sound output. Connect one end of the S/PDIF audio cable to this connector and the other end to the S/PDIF module.

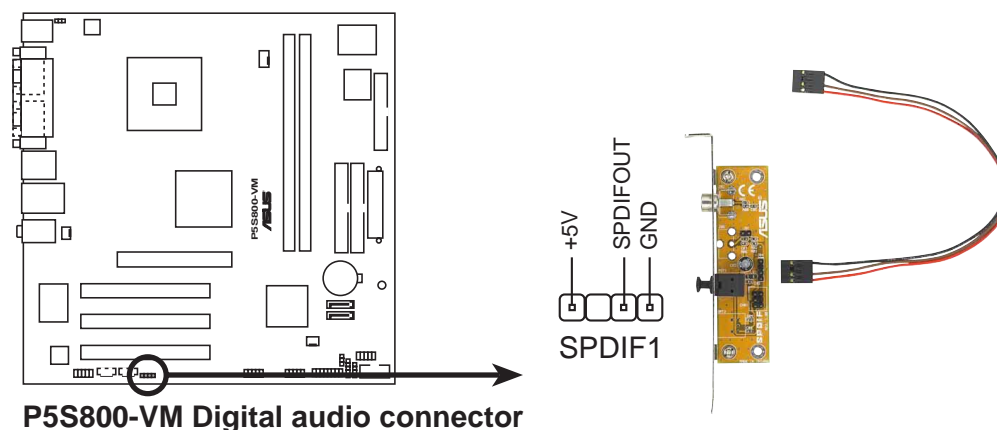

The S/PDIF out module is purchased separately.

## 7. ATX power connectors (20-pin ATXPWR1, 4-pin ATX12V1)

These connectors are for an ATX power supply. The plugs from the power supply are designed to fit these connectors in only one orientation. Find the proper orientation and push down firmly until the connectors completely fit.



- You can also use a Power Supply Unit (PSU) with a 24-pin ATX power connector on this motherboard.
- Do not forget to connect the 4-pin ATX +12 V power plug; otherwise, the system will not boot up.
- Use a PSU with a minimum power rating of 300 W on this motherboard. Use of a PSU with a higher power output is recommended when configuring a system with more power-consuming devices. The system may become unstable or may not boot up if the power is inadequate.

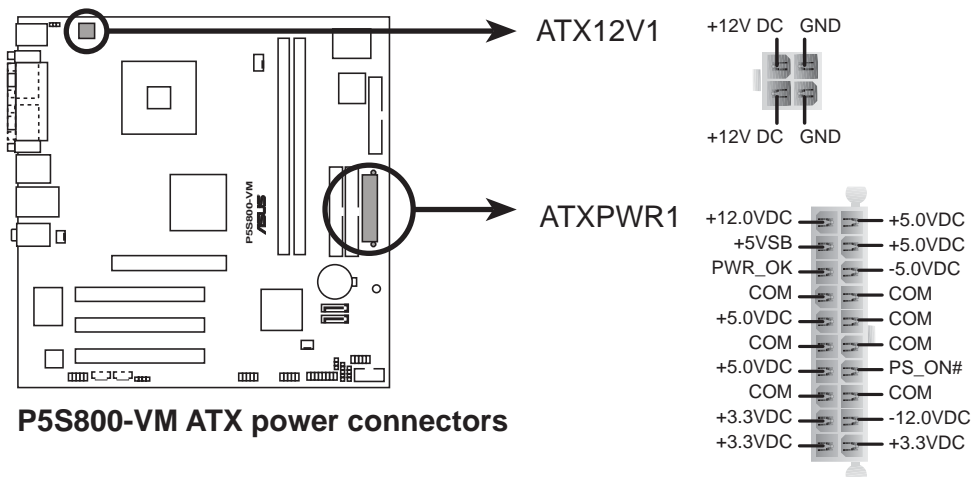

## 8. Power LED connector (3-1 pin PLED1)

This 3-1 pin connector is for the system power LED. The system power LED lights up when you turn on the system power, and blinks when the system is in sleep mode.

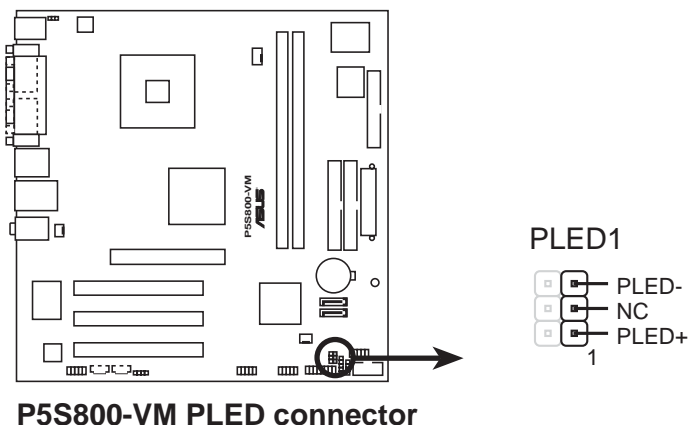

## 9. Internal audio connectors (4-pin CD1, AUX1)

These connectors allow you to receive stereo audio input from sound sources such as a CD-ROM, TV tuner, MPEG card or modem.

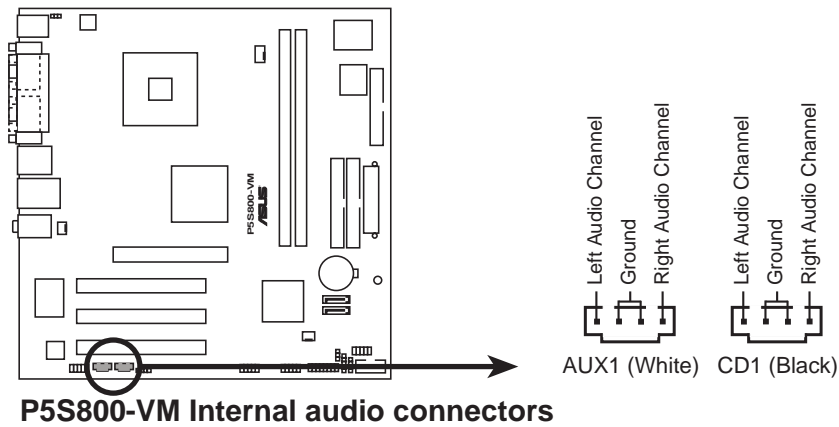

## 10. USB connectors (10-1 pin USB56, USB78)

These connectors are for USB 2.0 ports. Connect the optional USB/GAME module cable to any of these connectors, then install the module to a slot opening at the back of the system chassis. These USB connectors comply with USB 2.0 specification that supports up to 480 Mbps connection speed.

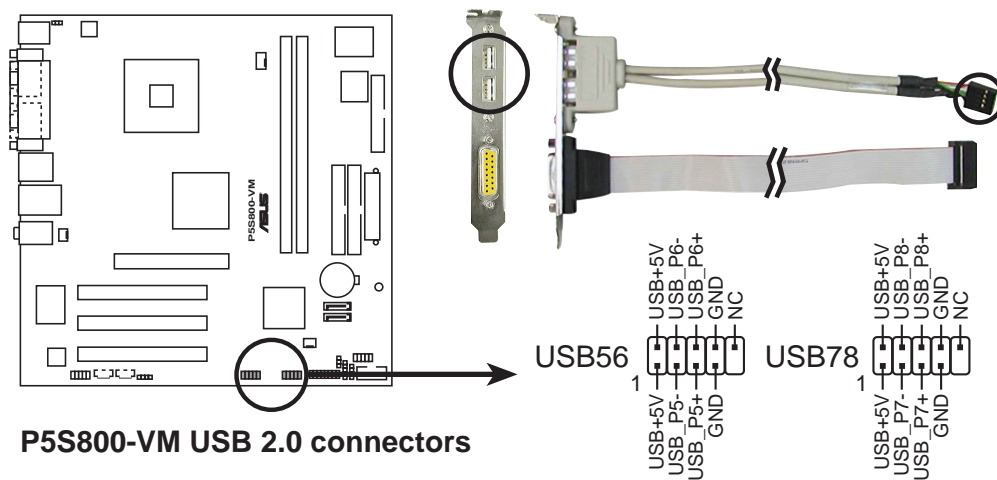

Never connect a **1394 cable** to the USB connectors. Doing so will damage the motherboard!



The USB/GAME module is purchased separately.



## 11. Front panel audio connector (10-1 pin FP\_AUDIO1)

This connector is for a chassis-mounted front panel audio I/O module that supports legacy AC '97 audio standard. Connect one end of the front panel audio I/O module cable to this connector.

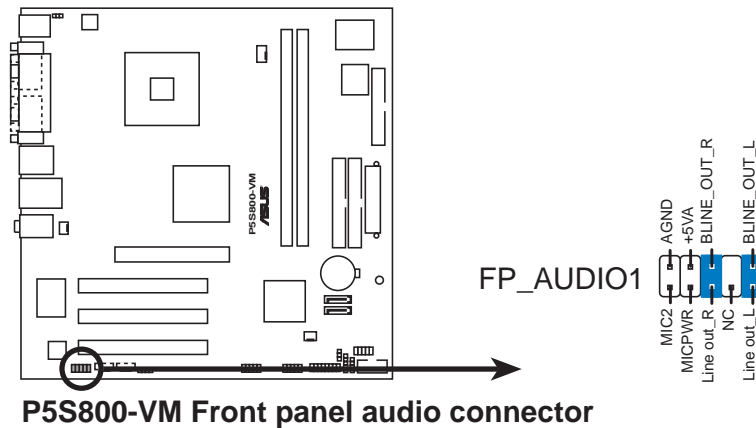

**P5S800-VM Front panel audio connector**

## 12. Serial port connector (10-1 pin COM2)

This connector is for a serial (COM) port. Connect the serial port module cable to this connector, then install the module to a slot opening at the back of the system chassis.

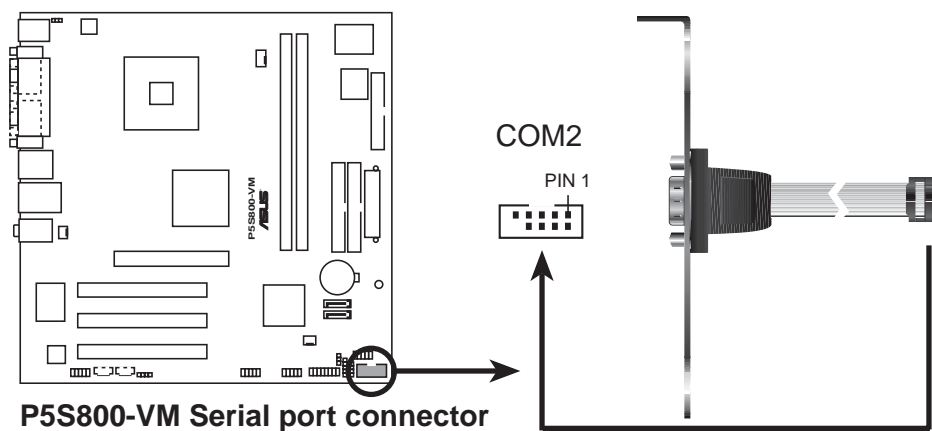

**P5S800-VM Serial port connector**



The Serial port module is purchased separately.

### 13. System panel connector (10-1 pin F\_PANEL1)

This connector supports several chassis-mounted functions.

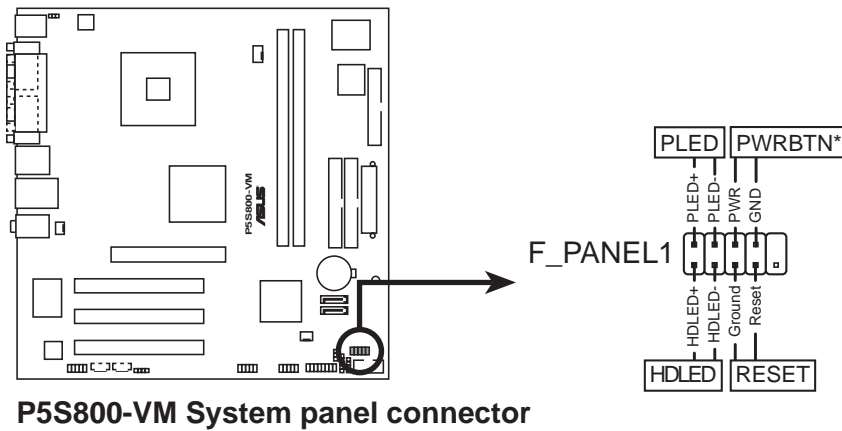

The system panel connector is color-coded for easy connection. Refer to the connector description below for details.

- **System power LED (Green 2-pin PLED)**  
This 2-pin connector is for the system power LED. Connect the chassis power LED cable to this connector. The system power LED lights up when you turn on the system power, and blinks when the system is in sleep mode.
- **Hard disk drive activity (Red 2-pin HDLED)**  
This 2-pin connector is for the HDD Activity LED. Connect the HDD Activity LED cable to this connector. The IDE LED lights up or flashes when data is read from or written to the HDD.
- **Power/Soft-off button (Black 2-pin PWRBTN)**  
This connector is for the system power button. Pressing the power button turns the system ON or puts the system in SLEEP or SOFT-OFF mode depending on the BIOS settings. Pressing the power switch for more than four seconds while the system is ON turns the system OFF.
- **Reset button (Blue 2-pin RESET)**  
This 2-pin connector is for the chassis-mounted reset button for system reboot without turning off the system power.

This chapter tells how to change the system settings through the BIOS Setup menus. Detailed descriptions of the BIOS parameters are also provided.

# BIOS setup

## 2.1 Managing and updating your BIOS

The following utilities allow you to manage and update the motherboard Basic Input/Output System (BIOS) setup.

1. **ASUS AFUDOS** (Updates the BIOS in DOS mode using a bootable floppy disk.)
2. **ASUS EZ Flash** (Updates the BIOS using a floppy disk during POST.)
3. **ASUS CrashFree BIOS 2** (Updates the BIOS using a bootable floppy disk or the motherboard support CD when the BIOS file fails or gets corrupted.)
4. **ASUS Update** (Updates the BIOS in Windows® environment.)

Refer to the corresponding sections for details on these utilities.



---

Save a copy of the original motherboard BIOS file to a bootable floppy disk in case you need to restore the BIOS in the future. Copy the original motherboard BIOS using the ASUS Update or AFUDOS utilities.

---

### 2.1.1 Creating a bootable floppy disk

1. Do either one of the following to create a bootable floppy disk.

#### DOS environment

- a. Insert a 1.44MB floppy disk into the drive.
- b. At the DOS prompt, type `format A: /S` then press <Enter>.

#### Windows® XP environment

- a. Insert a 1.44 MB floppy disk to the floppy disk drive.
- b. Click **Start** from the Windows® desktop, then select **My Computer**.
- c. Select the 3 1/2 Floppy Drive icon.
- d. Click **File** from the menu, then select **Format**. A **Format 3 1/2 Floppy Disk** window appears.
- e. Select **Create an MS-DOS startup disk** from the format options field, then click **Start**.

#### Windows® 2000 environment

To create a set of boot disks for Windows® 2000:

- a. Insert a formatted, high density 1.44 MB floppy disk into the drive.
- b. Insert the Windows® 2000 CD to the optical drive.
- c. Click **Start**, then select **Run**.

- d. From the Open field, type  
`D:\bootdisk\makeboot a:`  
assuming that D: is your optical drive.
  - e. Press <Enter>, then follow screen instructions to continue.
2. Copy the original or the latest motherboard BIOS file to the bootable floppy disk.

## 2.1.2 ASUS EZ Flash utility

The ASUS EZ Flash feature allows you to update the BIOS without having to go through the long process of booting from a floppy disk and using a DOS-based utility. The EZ Flash utility is built-in the BIOS chip so it is accessible by pressing <Alt> + <F2> during the Power-On Self Tests (POST).

To update the BIOS using EZ Flash:

1. Visit the ASUS website ([www.asus.com](http://www.asus.com)) to download the latest BIOS file for the motherboard and rename the same to **P5S800VM.ROM**.
2. Save the BIOS file to a floppy disk, then restart the system.
3. Press <Alt> + <F2> during POST to display the following.

```
EZFlash starting BIOS update
Checking for floppy...
```

4. Insert the floppy disk that contains the BIOS file to the floppy disk drive. When the correct BIOS file is found, EZ Flash performs the BIOS update process and automatically reboots the system when done.

```
EZFlash starting BIOS update
Checking for floppy...
Floppy found!
Reading file "P5S800VM.ROM". Completed.
Start erasing.....|
Start programming...|
Flashed successfully. Rebooting.
```



- Do not shutdown or reset the system while updating the BIOS to prevent system boot failure!
- A “Floppy not found!” error message appears if there is no floppy disk in the drive. A “P5S800VM.ROM not found!” error message appears if the correct BIOS file is not found in the floppy disk. Make sure that you rename the BIOS file to P5S800VM.ROM.

### 2.1.3 AFUDOS utility

The AFUDOS utility allows you to update the BIOS file in DOS environment using a bootable floppy disk with the updated BIOS file. This utility also allows you to copy the current BIOS file that you can use as backup when the BIOS fails or gets corrupted during the updating process.

#### Copying the current BIOS

To copy the current BIOS file using the AFUDOS utility:



- Make sure that the floppy disk is not write-protected and has at least 600 KB free space to save the file.
- The succeeding BIOS screens are for reference only. The actual BIOS screen displays may not be exactly the same as shown.

1. Copy the AFUDOS utility (afudos.exe) from the motherboard support CD to the bootable floppy disk you created earlier.
2. Boot the system in DOS mode, then at the prompt type:

```
afudos /o[filename]
```

where the [filename] is any user-assigned filename not more than eight alphanumeric characters for the main filename and three alphanumeric characters for the extension name.

```
A:\>afudos /oOLDBIOS1.ROM
```

Main filename      Extension name

3. Press <Enter>. The utility copies the current BIOS file to the floppy disk.

```
A:\>afudos /oOLDBIOS1.ROM
AMI Firmware Update Utility - Version 1.10
Copyright (C) 2002 American Megatrends, Inc. All rights reserved.
Reading flash ..... done
A:\>
```

The utility returns to the DOS prompt after copying the current BIOS file.

## Updating the BIOS file

To update the BIOS file using the AFUDOS utility:

1. Visit the ASUS website ([www.asus.com](http://www.asus.com)) and download the latest BIOS file for the motherboard. Save the BIOS file to a bootable floppy disk.



---

Write the BIOS filename on a piece of paper. You need to type the exact BIOS filename at the DOS prompt.

---

2. Copy the AFUDOS utility (afudos.exe) from the motherboard support CD to the bootable floppy disk you created earlier.
3. Boot the system in DOS mode, then at the prompt type:

```
afudos /i[filename]
```

where [filename] is the latest or the original BIOS file on the bootable floppy disk.

```
A:\>afudos /iP5S800VM.ROM
```

4. The utility verifies the file and starts updating the BIOS.

```
A:\>afudos /iP5S800VM.ROM
AMI Firmware Update Utility - Version 1.10
Copyright (C) 2002 American Megatrends, Inc. All rights reserved.
Reading file ..... done
Erasing flash .... done
Writing flash .... 0x0008CC00 (9%)
```



---

Do not shut down or reset the system while updating the BIOS to prevent system boot failure!

---

5. The utility returns to the DOS prompt after the BIOS update process is completed. Reboot the system from the hard disk drive.

```
A:\>afudos /iP5S800VM.ROM
AMI Firmware Update Utility - Version 1.10
Copyright (C) 2002 American Megatrends, Inc. All rights reserved.
Reading file ..... done
Erasing flash .... done
Writing flash .... 0x0008CC00 (9%)
Verifying flash .. done
A:\>
```

## 2.1.4 ASUS CrashFree BIOS 2 utility

The ASUS CrashFree BIOS 2 is an auto recovery tool that allows you to restore the BIOS file when it fails or gets corrupted during the updating process. You can update a corrupted BIOS file using the motherboard support CD or the floppy disk that contains the updated BIOS file.



- Prepare the motherboard support CD or the floppy disk containing the updated motherboard BIOS before using this utility.
- Make sure that you rename the original or updated BIOS file in the floppy disk to **P5S800VM.ROM**.

### Recovering the BIOS from a floppy disk

To recover the BIOS from a floppy disk:

1. Turn on the system.
2. Insert the floppy disk with the original or updated BIOS file to the floppy disk drive.
3. The utility displays the following message and automatically checks the floppy disk for the original or updated BIOS file.

```
Bad BIOS checksum. Starting BIOS recovery...  
Checking for floppy...
```

When found, the utility reads the BIOS file and starts flashing the corrupted BIOS file.

```
Bad BIOS checksum. Starting BIOS recovery...  
Checking for floppy...  
Floppy found!  
Reading file "P5S800VM.ROM". Completed.  
Start flashing...
```



DO NOT shut down or reset the system while updating the BIOS! Doing so can cause system boot failure!

4. Restart the system after the utility completes the updating process.



## Recovering the BIOS from the support CD

To recover the BIOS from the support CD:

1. Remove any floppy disk from the floppy disk drive, then turn on the system.
2. Insert the support CD to the optical drive.
3. The utility displays the following message and automatically checks the floppy disk for the original or updated BIOS file.

```
Bad BIOS checksum. Starting BIOS recovery...  
Checking for floppy...
```

When no floppy disk is found, the utility automatically checks the optical drive for the original or updated BIOS file. The utility then updates the corrupted BIOS file.

```
Bad BIOS checksum. Starting BIOS recovery...  
Checking for floppy...  
Floppy not found!  
Checking for CD-ROM...  
CD-ROM found!  
Reading file "P5S800VM.ROM". Completed.  
Start flashing...
```



---

DO NOT shut down or reset the system while updating the BIOS! Doing so can cause system boot failure!

---

4. Restart the system after the utility completes the updating process.



---

The recovered BIOS may not be the latest BIOS version for this motherboard. Visit the ASUS website ([www.asus.com](http://www.asus.com)) to download the latest BIOS file.

---

## 2.1.5 ASUS Update utility

The ASUS Update is a utility that allows you to manage, save, and update the motherboard BIOS in Windows® environment. The ASUS Update utility allows you to:

- Save the current BIOS file
- Download the latest BIOS file from the Internet
- Update the BIOS from an updated BIOS file
- Update the BIOS directly from the Internet, and
- View the BIOS version information.

This utility is available in the support CD that comes with the motherboard package.



---

ASUS Update requires an Internet connection either through a network or an Internet Service Provider (ISP).

---

### Installing ASUS Update

To install ASUS Update:

1. Place the support CD in the optical drive. The **Drivers** menu appears.
2. Click the **Utilities** tab, then click **Install ASUS Update VX.XX.XX**. See page 3-4 for the **Utilities** screen menu.
3. The ASUS Update utility is copied to your system.



---

Quit all Windows® applications before you update the BIOS using this utility.

---

## Updating the BIOS through the Internet

To update the BIOS through the Internet:

1. Launch the ASUS Update utility from the Windows® desktop by clicking **Start > Programs > ASUS > ASUSUpdate > ASUSUpdate**. The ASUS Update main window appears.

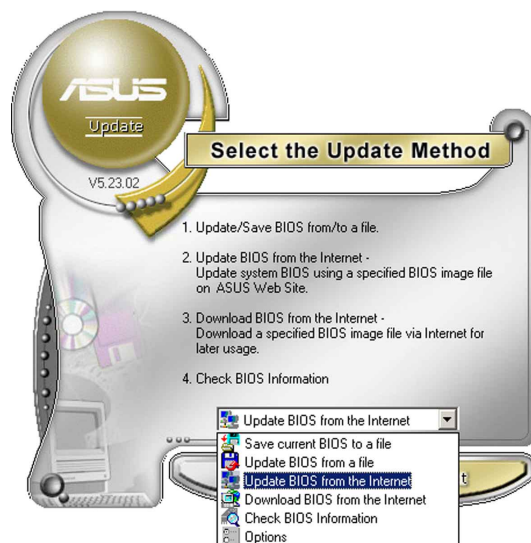
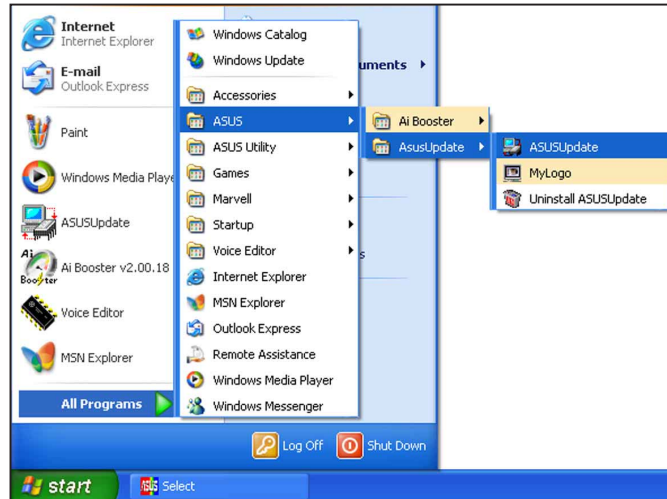

2. Select **Update BIOS from the Internet** option from the drop-down menu, then click **Next**.



3. Select the ASUS FTP site nearest you to avoid network traffic, or click **Auto Select**. Click **Next**.

- From the FTP site, select the BIOS version that you wish to download. Click Next.
- Follow the screen instructions to complete the update process.



The ASUS Update utility is capable of updating itself through the Internet. Always update the utility to avail all its features.

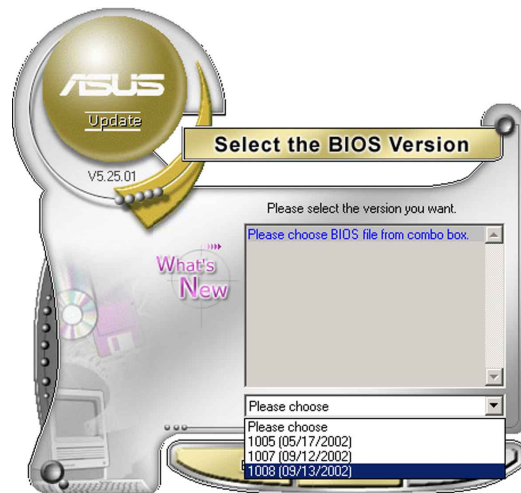

## Updating the BIOS through a BIOS file

To update the BIOS through a BIOS file:

- Launch the ASUS Update utility from the Windows® desktop by clicking **Start > Programs > ASUS > ASUSUpdate > ASUSUpdate**. The ASUS Update main window appears.
- Select **Update BIOS from a file** option from the drop-down menu, then click **Next**.

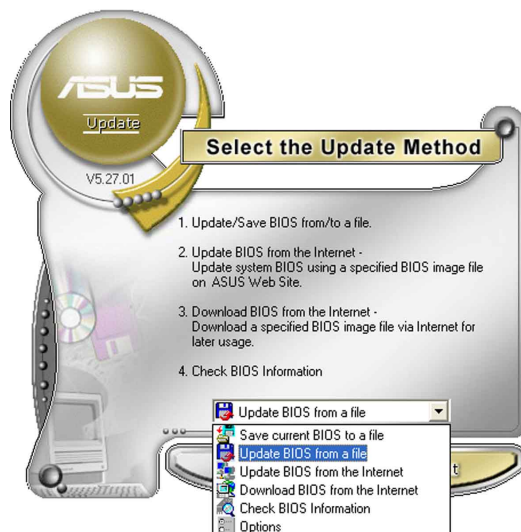

- Locate the BIOS file from the **Open** window, then click **Save**.
- Follow the screen instructions to complete the update process.

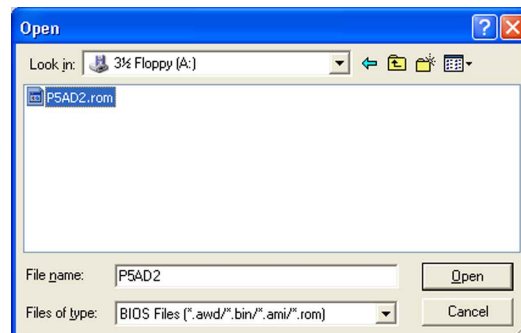

## 2.2 BIOS setup program

This motherboard supports a programmable firmware chip that you can update using the provided utility described in section “2.1 Managing and updating your BIOS.”

Use the BIOS Setup program when you are installing a motherboard, reconfiguring your system, or prompted to “Run Setup”. This section explains how to configure your system using this utility.

Even if you are not prompted to use the Setup program, you can change the configuration of your computer in the future. For example, you can enable the security password feature or change the power management settings. This requires you to reconfigure your system using the BIOS Setup program so that the computer can recognize these changes and record them in the CMOS RAM of the firmware hub.

The firmware hub on the motherboard stores the Setup utility. When you start up the computer, the system provides you with the opportunity to run this program. Press <Del> during the Power-On-Self-Test (POST) to enter the Setup utility; otherwise, POST continues with its test routines.

If you wish to enter Setup after POST, restart the system by pressing <Ctrl+Alt+Delete>, or by pressing the reset button on the system chassis. You can also restart by turning the system off and then back on. Do this last option only if the first two failed.

The Setup program is designed to make it as easy to use as possible. Being a menu-driven program, it lets you scroll through the various sub-menus and make your selections from the available options using the navigation keys.



- 
- The default BIOS settings for this motherboard apply for most conditions to ensure optimum performance. If the system becomes unstable after changing any BIOS settings, load the default settings to ensure system compatibility and stability. Select the **Load Default Settings** item under the Exit Menu. See section “2.7 Exit Menu.”
  - The BIOS setup screens shown in this section are for reference purposes only, and may not exactly match what you see on your screen.
  - Visit the ASUS website ([www.asus.com](http://www.asus.com)) to download the latest BIOS file for this motherboard and .
-

## 2.2.1 BIOS menu screen

Menu items      Menu bar      Configuration fields      General help

The screenshot shows the BIOS Setup Utility menu. At the top is a blue menu bar with the title 'BIOS SETUP UTILITY' and five main items: 'Main', 'Advanced', 'Power', 'Boot', and 'Exit'. The 'Main' item is currently selected and highlighted. Below the menu bar, the screen is divided into three main sections. The left section, labeled 'Menu items', contains a list of options: 'System Time', 'System Date', 'Legacy Diskette A', 'Primary IDE Master', 'Primary IDE Slave', 'Secondary IDE Master', 'Secondary IDE Slave', 'OnChip SATA Controller', and 'System Information'. The middle section, labeled 'Configuration fields', shows the current values for the selected items: '[11:51:19]', '[Thu 10/07/2004]', '[1.44M, 3.5 in]', ': [ST320413A]', ': [ASUS CD-S360]', ': [Not Detected]', ': [Not Detected]', and '[Enabled]'. The right section, labeled 'General help', contains instructions: 'Use [ENTER], [TAB] or [SHIFT-TAB] to select a field.' and 'Use [+] or [-] to configure system time.' At the bottom right, a box lists navigation keys: '←→ Select Screen', '↑↓ Select Item', '+- Change Option', 'F1 General Help', 'F10 Save and Exit', and 'ESC Exit'. At the bottom of the screen, a blue bar contains the copyright information: 'v00.00 (C)Copyright 1985-2002, American Megatrends, Inc.'

Sub-menu items      Navigation keys

## 2.2.2 Menu bar

The menu bar on top of the screen has the following main items:

- Main**      For changing the basic system configuration
- Advanced**      For changing the advanced system settings
- Power**      For changing the advanced power management (APM) configuration
- Boot**      For changing the system boot configuration
- Exit**      For selecting the exit options and loading default settings

To select an item on the menu bar, press the right or left arrow key on the keyboard until the desired item is highlighted.

## 2.2.3 Navigation keys

At the bottom right corner of a menu screen are the navigation keys for that particular menu. Use the navigation keys to select items in the menu and change the settings.



Some of the navigation keys differ from one screen to another.

## 2.2.4 Menu items

The highlighted item on the menu bar displays the specific items for that menu. For example, selecting **Main** shows the Main menu items.

The other items (Advanced, Power, Boot, and Exit) on the menu bar have their respective menu items.

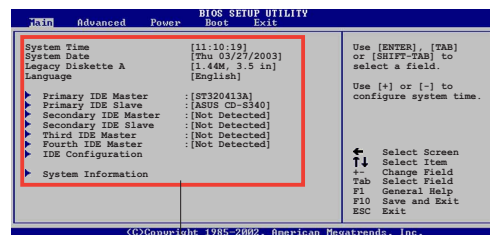

Main menu items

## 2.2.5 Sub-menu items

A solid triangle before each item on any menu screen means that the item has a sub-menu. To display the sub-menu, select the item and press <Enter>.

## 2.2.6 Configuration fields

These fields show the values for the menu items. If an item is user-configurable, you can change the value of the field opposite the item. You cannot select an item that is not user-configurable.

A configurable field is enclosed in brackets, and is highlighted when selected. To change the value of a field, select it then press <Enter> to display a list of options. Refer to “2.2.7 Pop-up window.”

## 2.2.7 Pop-up window

Select a menu item then press <Enter> to display a pop-up window with the configuration options for that item.

## 2.2.8 Scroll bar

A scroll bar appears on the right side of a menu screen when there are items that do not fit on the screen. Press the Up/Down arrow keys or <Page Up> / <Page Down> keys to display the other items on the screen.

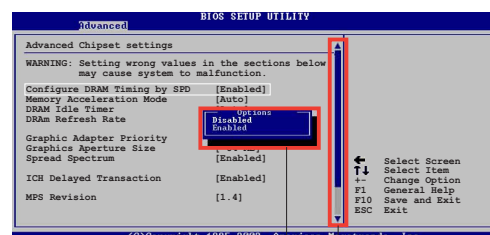

Pop-up window

Scroll bar

## 2.2.9 General help

At the top right corner of the menu screen is a brief description of the selected item.



## 2.3 Main menu

When you enter the BIOS Setup program, the Main menu screen appears, giving you an overview of the basic system information.



Refer to section “2.2.1 BIOS menu screen” for information on the menu screen items and how to navigate through them.

```

BIOS SETUP UTILITY
Main  Advanced  Power  Boot  Exit
-----
System Time           [11:51:19]
System Date           [Thu 10/07/2004]
Legacy Diskette A     [1.44M, 3.5 in]

▶ Primary IDE Master   : [ST320413A]
▶ Primary IDE Slave    : [ASUS CD-S360]
▶ Secondary IDE Master : [Not Detected]
▶ Secondary IDE Slave  : [Not Detected]

OnChip SATA Controller [Enabled]
▶ System Information

                                  ↔ Select Screen
                                  ↑↓ Select Item
                                  +- Change Option
                                  F1  General Help
                                  F10 Save and Exit
                                  ESC  Exit

v00.00 (C)Copyright 1985-2002, American Megatrends, Inc.
```

### 2.3.1 System Time [xx:xx:xxxx]

Allows you to set the system time.

### 2.3.2 System Date [Day xx/xx/xxxx]

Allows you to set the system date.

### 2.3.3 Legacy Diskette A [1.44M, 3.5 in.]

Sets the type of floppy drive installed. Configuration options: [Disabled]  
[360K, 5.25 in.] [1.2M , 5.25 in.] [720K , 3.5 in.] [1.44M, 3.5 in.]  
[2.88M, 3.5 in.]



## 2.3.4 Primary and Secondary IDE Master/Slave

While entering Setup, the BIOS automatically detects the presence of IDE devices. There is a separate sub-menu for each IDE device. Select a device item then press <Enter> to display the IDE device information.

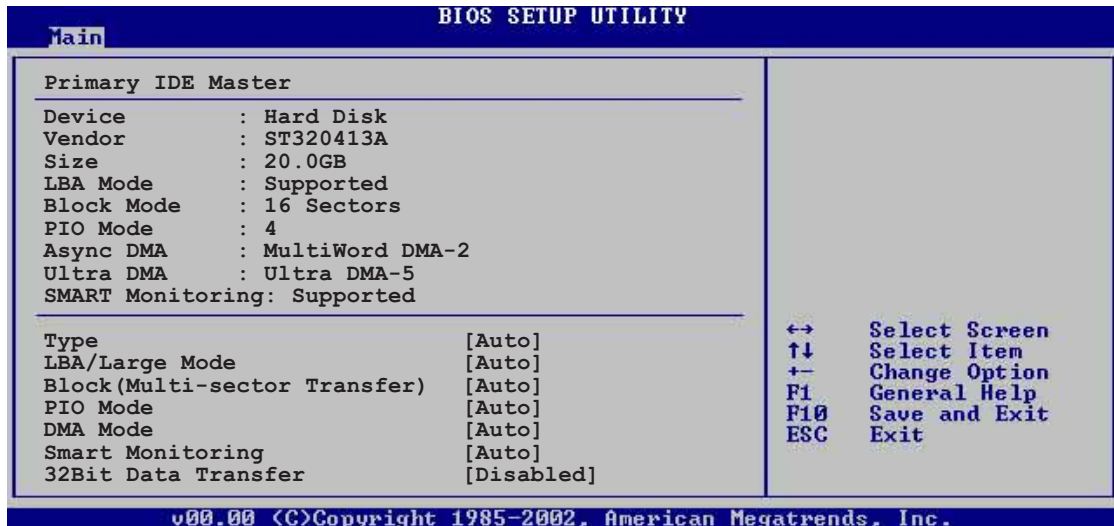

The BIOS automatically detects the values opposite the dimmed items (Device, Vendor, Size, LBA Mode, Block Mode, PIO Mode, Async DMA, Ultra DMA, and SMART monitoring). These values are not user-configurable. These items show N/A if no IDE device is installed in the system.

### Type [Auto]

Selects the type of IDE drive. Setting to Auto allows automatic selection of the appropriate IDE device type. Select CDROM if you are specifically configuring a CD-ROM drive. Select ARMD (ATAPI Removable Media Device) if your device is either a ZIP, LS-120, or MO drive.

Configuration options: [Not Installed] [Auto] [CDROM] [ARMD]

### LBA/Large Mode [Auto]

Enables or disables the LBA mode. Setting to Auto enables the LBA mode if the device supports this mode, and if the device was not previously formatted with LBA mode disabled.

Configuration options: [Disabled] [Auto]

### Block (Multi-sector Transfer) [Auto]

Enables or disables data multi-sectors transfers. When set to Auto, the data transfer from and to the device occurs multiple sectors at a time if the device supports multi-sector transfer feature. When set to [Disabled], the data transfer from and to the device occurs one sector at a time.

Configuration options: [Disabled] [Auto]

### **PIO Mode [Auto]**

Selects the PIO mode.

Configuration options: [Auto] [0] [1] [2] [3] [4]

### **DMA Mode [Auto]**

Selects the DMA mode. Configuration options: [Auto] [SWDMA0] [SWDMA1] [SWDMA2] [MWDMA0] [MWDMA1] [MWDMA2] [UDMA0] [UDMA1] [UDMA2]

### **SMART Monitoring [Auto]**

Sets the Smart Monitoring, Analysis, and Reporting Technology.

Configuration options: [Auto] [Disabled] [Enabled]

### **32Bit Data Transfer [Disabled]**

Enables or disables 32-bit data transfer.

Configuration options: [Disabled] [Enabled]

## **2.3.5 OnChip SATA Controller [Enabled]**

Enables or disables the onchip Serial ATA controller.

Configuration options: [Disabled] [Enabled]

## **2.3.6 System Information**

This menu gives you an overview of the general system specifications. The BIOS automatically detects the items in this menu.

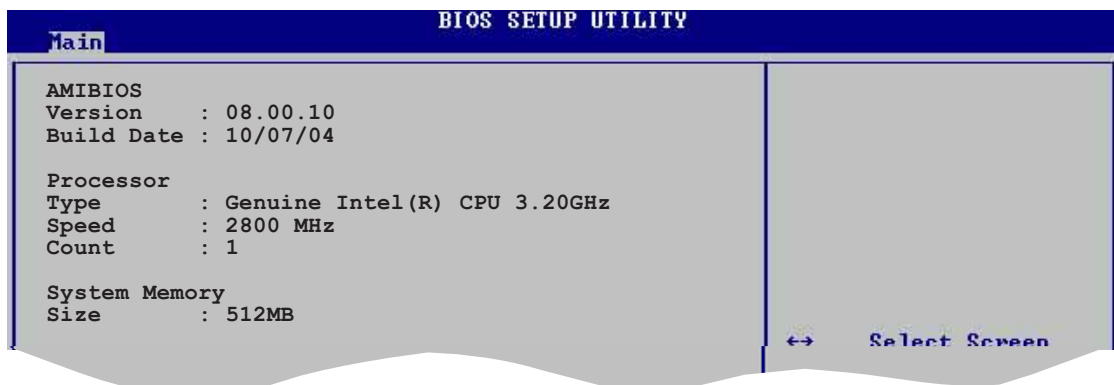

### **AMI BIOS**

Displays the auto-detected BIOS information

### **Processor**

Displays the auto-detected CPU specification

### **System Memory**

Displays the auto-detected system memory

## 2.4 Advanced menu

The Advanced menu items allow you to change the settings for the CPU and other system devices.



Take caution when changing the settings of the Advanced menu items. Incorrect field values may cause the system to malfunction.

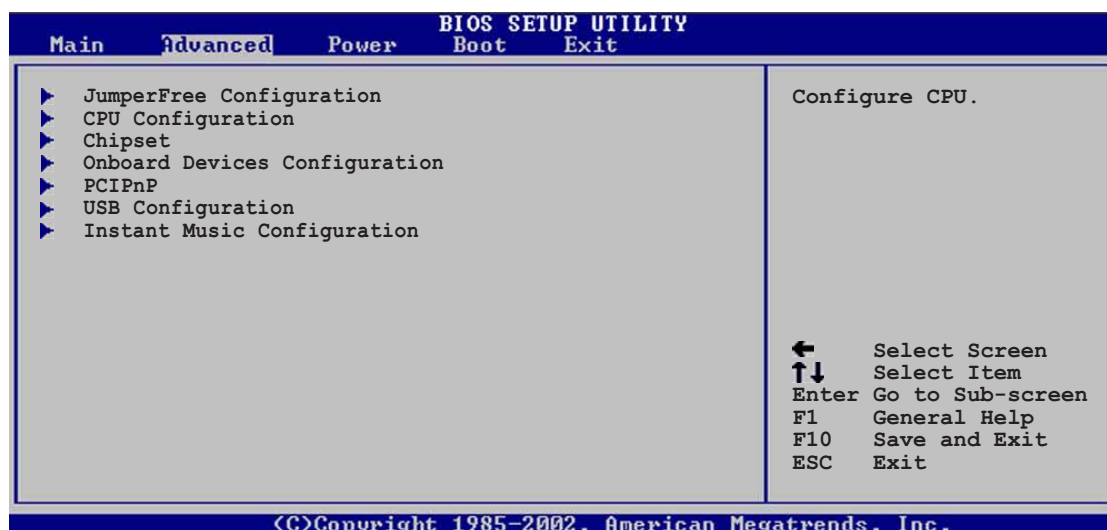

### 2.4.1 JumperFree Configuration

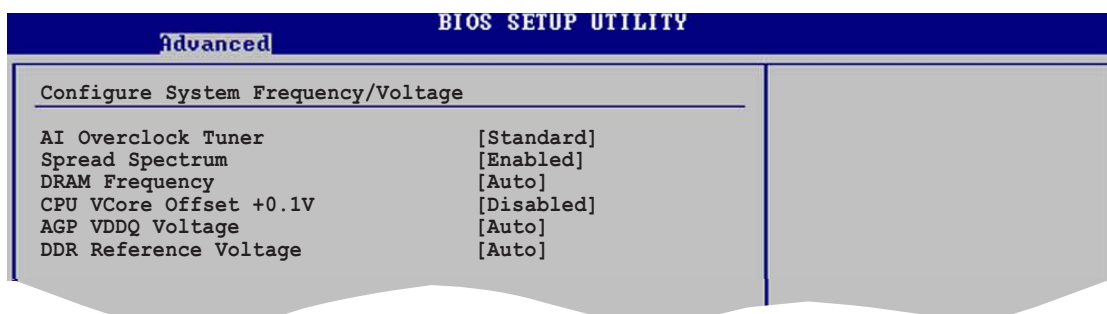

#### AI Overclock Tuner [Standard]

Allows selection of CPU overclocking options to achieve desired CPU internal frequency. Select either one of the preset overclocking options. Configuration options: [Manual] [Standard]



Selecting a very high CPU frequency may cause the system to become unstable! If this happens, revert to the default setting.

### **CPU Frequency [XXX] (value is auto-detected)**

Indicates the frequency sent by the clock generator to the system bus and PCI bus. The bus frequency (external frequency) multiplied by the bus multiple equals the CPU speed. The value of this item is auto-detected by BIOS. The values range from 100 to 400. This item appears only when the **AI Overclock Tuner** item is set to Manual.

### **AGP/PCI Frequency [Auto]**

Sets the AGP/PCI frequency. Configuration options: [Auto] [66.6/33.3] [75.0/37.5] [85.7/42.8]

### **Spread Spectrum [Enabled]**

Enables or disables the generator spread spectrum.  
Configuration options: [Disabled] [Enabled]

### **DRAM Frequency [Auto]**

Sets the DDR operating frequency. Configuration options: [200 Mhz] [266 Mhz] [333 Mhz] [400 Mhz] [Auto]

### **CPU VCore Offset +0.1V [Disabled]**

Allows you to enable or disable the CPU VCore Offset voltage.  
Configuration options: [Disabled] [Enabled]

### **AGP VDDQ Voltage [Auto]**

Allows you to automatically detect or select from a list the AGP VDDQ operating voltage. Configuration options: [1.50V] [1.60V] [1.70] [1.80V] [Auto]

### **DDR Reference Voltage [Auto]**

This item allows you to automatically detect or select from a list the DDR reference voltage. Configuration options: [2.55V] [2.65V] [2.75V] [2.85V] [Auto]

## 2.4.2 CPU Configuration

The items in this menu show the CPU-related information auto-detected by BIOS.

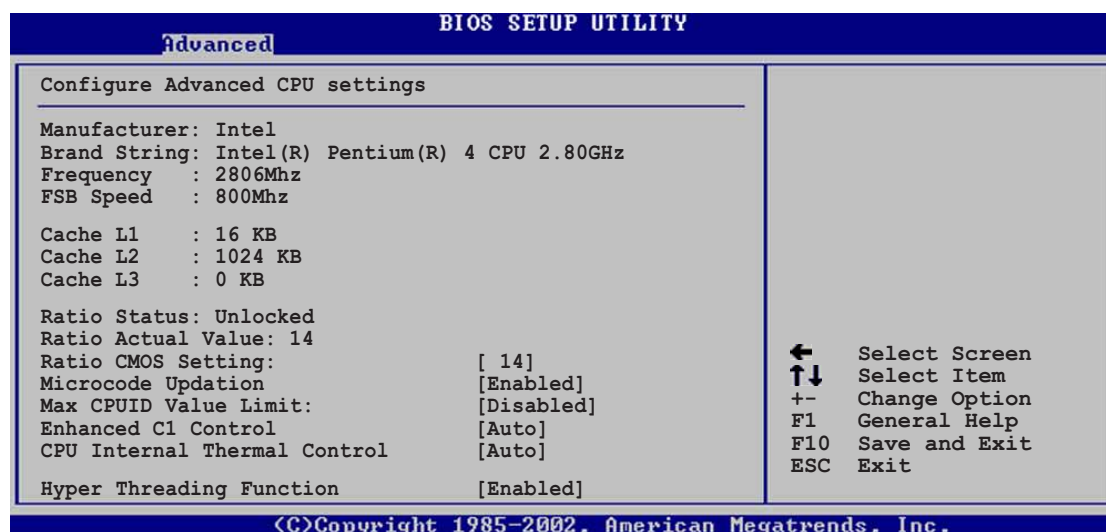

### Ratio CMOS Setting [ 14]

Sets the ratio between the CPU core clock and the FSB frequency.

### Microcode Updation [Enabled]

Enables or disables the Microcode updation feature.

Configuration options: [Enabled] [Disabled]

### Max CPUID Value Limit [Disabled]

This item allows you to enable or disable the maximum CPUID value limit.

Configuration options: [Disabled] [Enabled]

### Enhanced C1 Control [Auto]

When set to Auto, the BIOS checks if the CPU supports the Intel® Enhanced Halt State mode. In Enhanced Halt State mode, the CPU's power consumption is lower in idle state. Configuration options: [Auto] [Disabled]

### CPU Internal Thermal Control [Auto]

This item allows you to disable or set to auto the Intel® Thermal Monitoring 2 feature. Configuration options: [Auto] [Disabled]

### Hyper-Threading Function [Enabled]

This item allows you to enable or disable the processor Hyper-Threading Technology. Configuration options: [Disabled] [Enabled]

## 2.4.3 Chipset

The Chipset menu items allow you to change the advanced chipset settings. Select an item then press <Enter> to display the sub-menu.

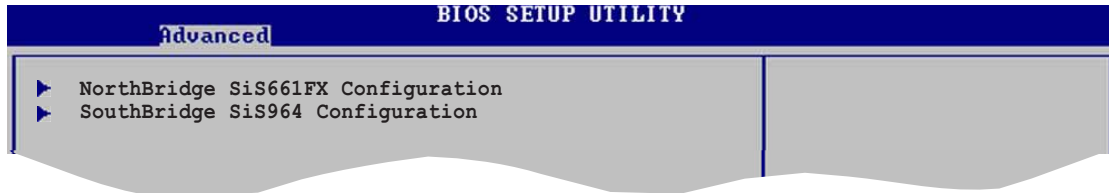

### NorthBridge SiS661FX Configuration

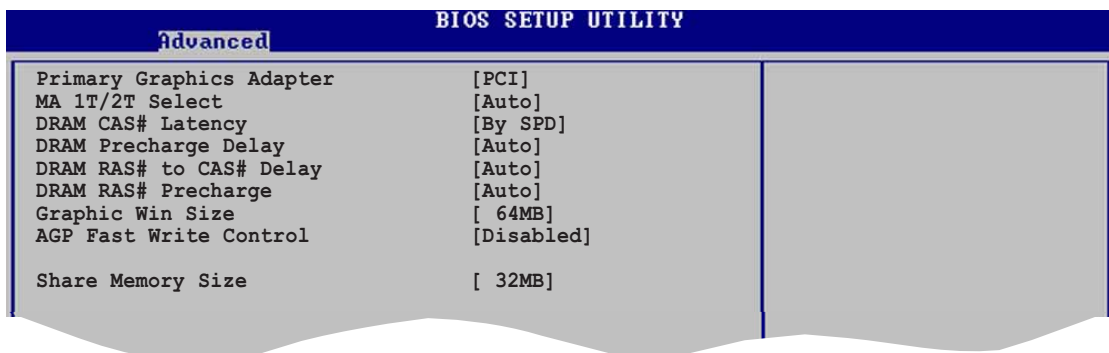

#### Primary Graphics Adapter [PCI]

Allows selection of the graphics controller to use as primary boot device.  
Configuration options: [PCI] [AGP] [Onboard AGP]

#### MA 1T/2T Select [Auto]

Configuration options: [Auto] [MA 2T] [1T]

#### DRAM CAS# Latency [By SPD]

This item controls the latency between the SDRAM read command and the time the data actually becomes available.

Configuration options: [By SPD] [2T] [2.5T] [3T]

#### DRAM Precharge Delay [Auto]

Configuration options: [Auto] [6T] [7T] [5T] [4T] [8T] [9T]

#### DRAM RAS# to CAS# Delay [Auto]

This item controls the latency between the DDR SDRAM active command and the read/write command.

Configuration options: [Auto] [3T] [2T] [4T] [5T]

#### DRAM RAS# Precharge [Auto]

This item controls the idle clocks after issuing a precharge command to the DDR SDRAM. Configuration options: [Auto] [3T] [2T] [4T] [5T]

## Graphics Win Size [64MB]

Allows you to select the size of mapped memory for AGP graphic data.  
Configuration options: [32MB] [64MB] [128MB]

## AGP Fast Write Control [Disabled]

Disables or enables the AGP Fast Write Control function.  
Configuration options: [Disabled] [Enabled]

## Share Memory Size [32MB]

Sets the share memory size. Configuration options: [16MB] [32MB] [64MB] [128MB] [Disabled]

## SouthBridge SiS964 Configuration

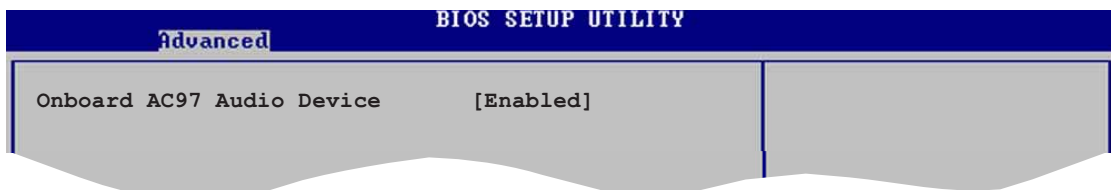

## Onboard AC97 Audio Device [Enabled]

This item enables or disables the onboard AC'97 audio CODEC device.  
Configuration options: [Disabled] [Enabled]

## 2.4.4 Onboard Devices Configuration

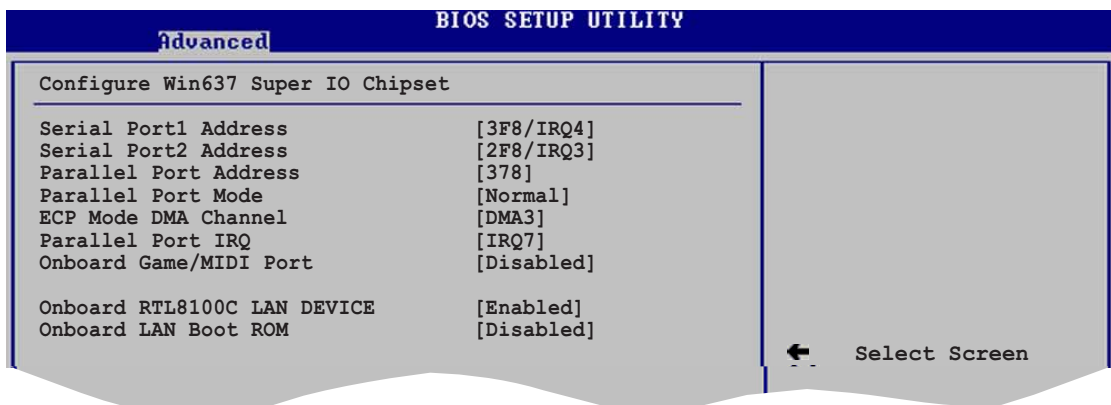

## Serial Port1 Address [3F8/IRQ4]

Allows you to select the Serial Port1 base address.  
Configuration options: [Disabled] [3F8/IRQ4] [3E8/IRQ4] [2E8/IRQ3]

## Serial Port2 Address [2F8/IRQ3]

Allows you to select the Serial Port2 base address. Configuration options: [Disabled] [2F8/IRQ3] [3E8/IRQ4] [2E8/IRQ3]

## **Parallel Port Address [378]**

Allows you to select the Parallel Port base addresses. Configuration options: [Disabled] [378] [278] [3BC]

## **Parallel Port Mode [Normal]**

Allows you to select the Parallel Port mode. When the item **Parallel Port Address** is set to **3BC**, the Parallel Port Mode options are only Normal, Bi-directional, and ECP. Configuration options: [Normal] [Bi-directional] [EPP] [ECP]

### *EPP Version [1.9]*

Allows selection of the Parallel Port EPP version. This item appears only when the **Parallel Port Mode** is set to **EPP**. Configuration options: [1.9] [1.7]

### *Parallel Port IRQ [IRQ7]*

Allows you to select the Parallel Port IRQ. Configuration options: [IRQ5] [IRQ7]

### *ECP Mode DMA Channel [DMA3]*

Allows selection of the Parallel Port ECP DMA channel. This item appears only when the **Parallel Port Mode** is set to **ECP**. Configuration options: [DMA0] [DMA1] [DMA3]

## **Onboard Game/MIDI Port [Disabled]**

Allows you to set the onboard Game/MIDI port address or disable the port. Configuration options: [Disabled] [200/300] [200/300] [208/300] [208/300]

## **Onboard RTL8100C LAN DEVICE [Enabled]**

Enables or disables the onboard RTL8100C LAN device. Configuration options: [Disabled] [Enabled]

## **OnBoard LAN Boot ROM [Disabled]**

Allows you to enable or disable the onboard LAN Boot ROM. Configuration options: [Disabled] [Enabled]



## 2.4.5 PCI PnP

The PCI PnP menu items allow you to change the advanced settings for PCI/PnP devices. The menu includes setting IRQ and DMA channel resources for either PCI/PnP or legacy ISA devices, and setting the memory size block for legacy ISA devices.



Take caution when changing the settings of the PCI PnP menu items. Incorrect field values can cause the system to malfunction.

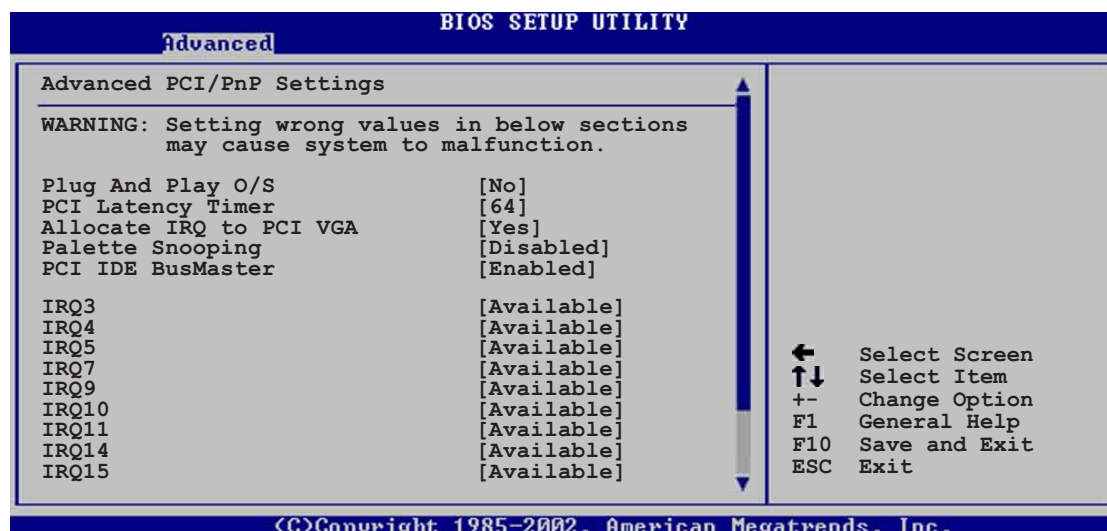

### Plug and Play O/S [No]

When set to [No], BIOS configures all the devices in the system. When set to [Yes] and if you install a Plug and Play operating system, the operating system configures the Plug and Play devices not required for boot. Configuration options: [No] [Yes]

### PCI Latency Timer [64]

Allows you to select the value in units of PCI clocks for the PCI device latency timer register. Configuration options: [32] [64] [96] [128] [160] [192] [224] [248]

### Allocate IRQ to PCI VGA [Yes]

When set to [Yes], BIOS assigns an IRQ to PCI VGA card if the card requests for an IRQ. When set to [No], BIOS does not assign an IRQ to the PCI VGA card even if requested. Configuration options: [No] [Yes]

### Palette Snooping [Disabled]

When set to [Enabled], the palette snooping feature informs the PCI devices that an ISA graphics device is installed in the system so that the latter can function correctly. Configuration options: [Disabled] [Enabled]

## PCI IDE BusMaster [Enabled]

Allows BIOS to use PCI bus mastering when reading/writing to IDE devices.  
Configuration options: [Disabled] [Enabled]

## IRQ xx assigned to [Available]

When set to [Available], the specific IRQ is free for use of PCI/PnP devices.  
When set to [Reserved], the IRQ is reserved for legacy ISA devices.  
Configuration options: [Available] [Reserved]

## 2.4.6 USB Configuration

The items in this menu allows you to change the USB-related features.  
Select an item then press Enter to display the configuration options.

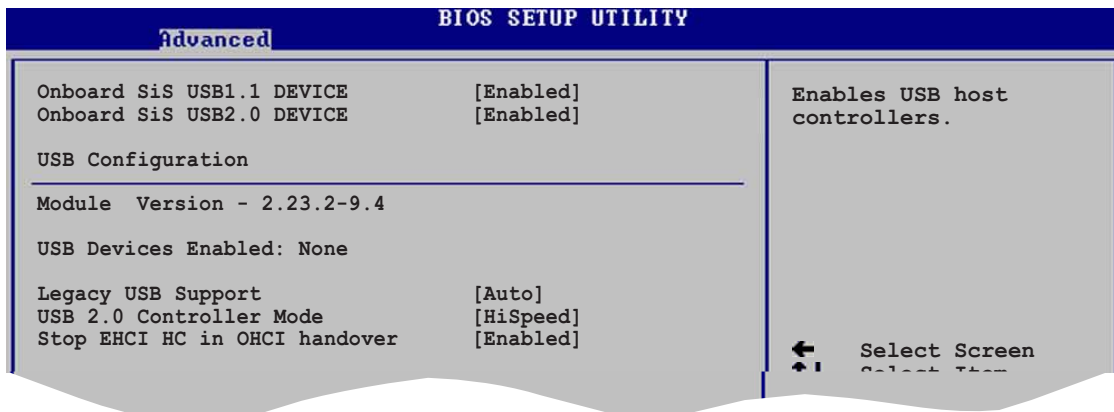

### OnBoard SiS USB 1.1 Device [Enabled]

Allows you to enable or disable the onboard SiS USB 1.1 device.  
Configuration options: [Disabled] [Enabled]

### OnBoard SiS USB 2.0 Device [Enabled]

Allows you to enable or disable the onboard SiS USB 2.0 device.  
Configuration options: [Disabled] [Enabled]



- The Module Version and USB Devices Enabled items show the auto-detected values. If no USB device is detected, the item shows None.
- Set to [Disabled] if you are using a Windows 98SE or Windows ME OS.

### Legacy USB Support [Auto]

Allows you to enable or disable support for legacy USB devices. Setting to Auto allows the system to detect the presence of USB devices at startup. If detected, the USB controller legacy mode is enabled. If no USB device is detected, the legacy USB support is disabled.  
Configuration options: [Disabled] [Enabled] [Auto]

## USB 2.0 Controller Mode [HiSpeed]

Allows you to configure the USB 2.0 controller in HiSpeed (480 Mbps) or Full Speed (12 Mbps). Configuration options: [HiSpeed ] [Full Speed]

## Stop EHCI HC in OHCI handover [Enabled]

Allows you to enable or disable the feature to stop the EHCI host controller during the OHCI OS handover call. This is needed when installing operating systems that do not support EHCI host controllers. Configuration options: [Disabled] [Enabled]

## 2.4.7 Instant Music Configuration



### Instant Music [Disabled]

Allows you to enable or disable the Instant Music feature in BIOS. Configuration options: [Disabled] [Enabled]



When Instant Music is enabled, the PS/2 keyboard power up feature is automatically disabled.

### Instant Music CD-ROM Drive [IDE Secondary Master]

Allows you to select the CD-ROM drive that you wish to use for the Instant Music CD playback. Configuration options: [IDE Primary Master] [IDE Primary Slave] [IDE Secondary Master] [IDE Secondary Slave]



The above item appears only if you enabled the Instant Music item.

## 2.5 Power menu

The Power menu items allow you to change the settings for the Advanced Configuration and Power Interface (ACPI) and the Advanced Power Management (APM). Select an item then press <Enter> to display the configuration options.

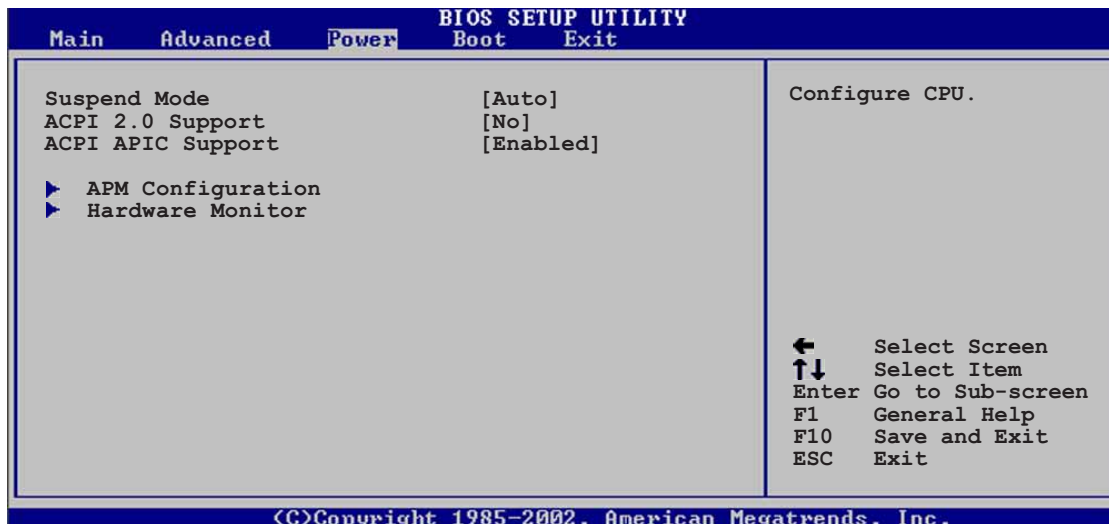

### 2.5.1 Suspend Mode [Auto]

Allows you to select the Advanced Configuration and Power Interface (ACPI) state to be used for system suspend.

Configuration options: [S1 (POS) Only] [Auto] [S3 Only]

### 2.5.2 ACPI 2.0 Support [No]

Allows you to add more tables for Advanced Configuration and Power Interface (ACPI) 2.0 specifications. Configuration options: [No] [Yes]

### 2.5.3 ACPI APIC Support [Enabled]

Allows you to enable or disable the Advanced Configuration and Power Interface (ACPI) support in the Application-Specific Integrated Circuit (ASIC). When set to Enabled, the ACPI APIC table pointer is included in the RSDT pointer list. Configuration options: [Disabled] [Enabled]

## 2.5.5 APM Configuration

BIOS SETUP UTILITY	
Power	
Power Button Mode	[On/Off]
Restore on AC Power Loss	[Always OFF]
Power On By PS2 Keyboard	[Disabled]
Power On By PS2 Mouse	[Disabled]
Power On by PCI Devices	[Disabled]
Power On By External Modems	[Disabled]
Power On By RTC Alarm	[Disabled]

### Power Button Mode [On/Off]

Allows the system to go into On/Off mode or suspend mode when the power button is pressed. Configuration options: [On/Off] [Suspend]

### Restore on AC Power Loss [Always OFF]

When set to Power Off, the system goes into off state after an AC power loss. When set to Power On, the system goes on after an AC power loss. When set to Last State, the system goes into either off or on state, whatever the system state was before the AC power loss.

Configuration options: [Always OFF] [Always On] [Keep Previous State]

### Power On By PS/2 Keyboard [Disabled]

Allows you to disable the PS/2 Power-On by keyboard feature or use specific keys on the keyboard to turn on the system. This feature requires an ATX power supply that provides at least 1A on the +5VSB lead.

Configuration options: [Disabled] [Space Bar] [Ctrl-Esc] [Power Key]

### Power On By PS/2 Mouse [Disabled]

When set to [Enabled], this parameter allows you to use the PS/2 mouse to turn on the system. This feature requires an ATX power supply that provides at least 1A on the +5VSB lead.

Configuration options: [Disabled] [Enabled]

### Power On By PCI Devices [Disabled]

When set to [Enabled], this parameter allows you to turn on the system through a PCI LAN or modem card. This feature requires an ATX power supply that provides at least 1A on the +5VSB lead.

Configuration options: [Disabled] [Enabled]

## Power On By External Modems [Disabled]

This allows either settings of [Enabled] or [Disabled] for powering up the computer when the external modem receives a call while the computer is in Soft-off mode. Configuration options: [Disabled] [Enabled]



The computer cannot receive or transmit data until the computer and applications are fully running. Thus, connection cannot be made on the first try. Turning an external modem off and then back on while the computer is off causes an initialization string that turns the system power on.

## Power On By RTC Alarm [Disabled]

Allows you to enable or disable RTC to generate a wake event. When this item is set to Enabled, the items RTC Alarm Date, RTC Alarm Hour, RTC Alarm Minute, and RTC Alarm Second appear with set values. Configuration options: [Disabled] [Enabled]

## 2.5.6 Hardware Monitor

BIOS SETUP UTILITY	
Power	
Hardware Monitor	
CPU Temperature	[51°C/122.5°F]
MB Temperature	[41°C/105.5°F]
CPU Fan Speed	[3813 RPM]
Chassis Fan Speed	[N/A]
Power Fan Speed	[N/A]
VCORE Voltage	[ 1.320V]
3.3V Voltage	[ 3.345V]
5V Voltage	[ 5.094V]
12V Voltage	[11.880V]
↔	Select Screen
↑↓	Select Item
+−	Change Option
F1	General Help

### CPU Temperature [xxxC/xxxF]

### MB Temperature [xxxC/xxxF]

The onboard hardware monitor automatically detects and displays the motherboard and CPU temperatures. Select Ignored if you do not wish to display the detected temperatures.

### CPU Fan Speed [xxxxRPM] or [N/A]

The onboard hardware monitor automatically detects and displays the CPU fan speed in rotations per minute (RPM). If the fan is not connected to the motherboard, the field shows N/A. Select Ignored if you do not wish to display the detected fan speed.

### **CPU Target Temperature [xxx°C]**

Allows you to set the CPU temperature threshold when the CPU fan speed is increased to lower the CPU temperature. This item appears only when the CPU Q-Fan Control item is Enabled. The configuration options vary depending on the CPU installed.

### **Chassis Fan Speed [xxxxRPM] or [N/A]**

The onboard hardware monitor automatically detects and displays the chassis fan speed in rotations per minute (RPM). If the fan is not connected to the chassis, the specific field shows N/A. Select Ignored if you do not wish to display the detected fan speed.

### **Power Fan Speed [xxxxRPM] or [N/A]**

The onboard hardware monitor automatically detects and displays the power fan speed in rotations per minute (RPM). If the fan is not connected to the power fan connector, the specific field shows N/A. Select Ignored if you do not wish to display the detected fan speed.

### **VCORE Voltage, 3.3V Voltage, 5V Voltage, 12V Voltage**

The onboard hardware monitor automatically detects the voltage output through the onboard voltage regulators.

## 2.6 Boot menu

The Boot menu items allow you to change the system boot options. Select an item then press <Enter> to display the sub-menu.

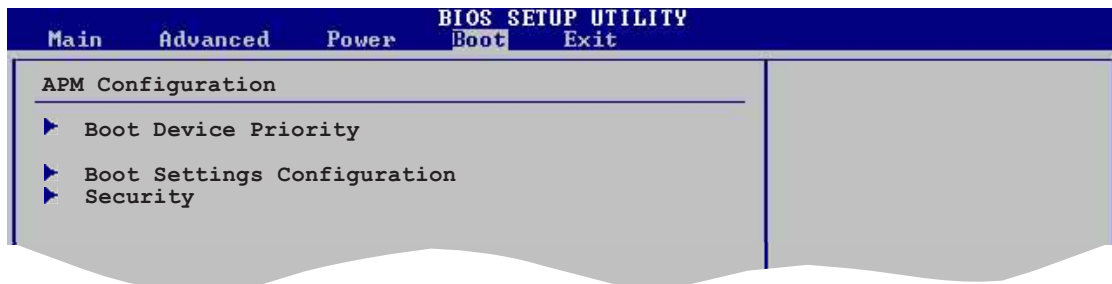

### 2.6.1 Boot Device Priority

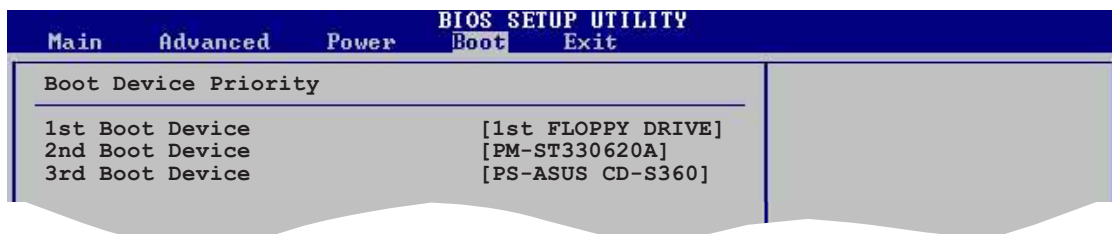

#### 1st ~ xxth Boot Device [1st Floppy Drive]

These items specify the boot device priority sequence from the available devices. The number of device items that appears on the screen depends on the number of devices installed in the system.

Configuration options: [xxxxx Drive] [Disabled]

### 2.6.2 Hard Disk Drives

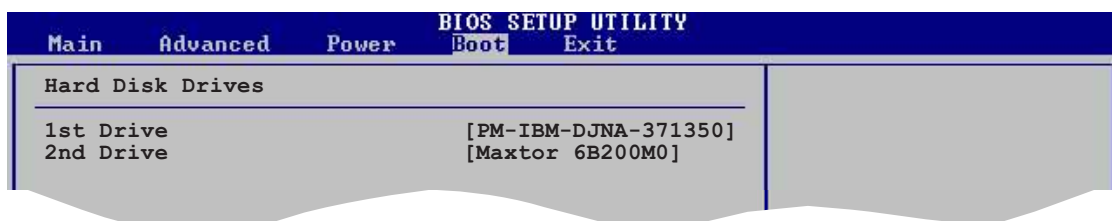

#### 1st ~ xxth Drive [XXXXXXXXXXXXXXXXXXXX]

These items displays the available hard disk drives. The number of device items that appears on the screen depends on the number of devices installed in the system. This item appears only when you install additional disk drives on your system. Configuration options: [xxxxx Drive] [Disabled]



## 2.6.3 Boot Settings Configuration

BIOS SETUP UTILITY				
Main	Advanced	Power	Boot	Exit
<b>Boot Settings Configuration</b>				Allows BIOS to skip certain tests while booting. This will decrease the time needed to boot the system.
Quick Boot			[Enabled]	
Full Screen Logo			[Enabled]	
AddOn ROM Display Mode			[Force BIOS]	
Bootup Num-Lock			[On]	
PS/2 Mouse Support			[Auto]	
Wait For 'F1' If Error			[Enabled]	
Hit 'DEL' Message Display			[Enabled]	
Interrupt 19 Capture			[Disabled]	

### Quick Boot [Enabled]

Enabling this item allows the BIOS to skip some power on self tests (POST) while booting to decrease the time needed to boot the system. When set to [Disabled], BIOS performs all the POST items.

Configuration options: [Disabled] [Enabled]

### Full Screen Logo [Enabled]

This allows you to enable or disable the full screen logo display feature.

Configuration options: [Disabled] [Enabled]



---

Set this item to [Enabled] to use the ASUS MyLogo2™ feature.

---

### Add On ROM Display Mode [Force BIOS]

Sets the display mode for option ROM.

Configuration options: [Force BIOS] [Keep Current]

### Bootup Num-Lock [On]

Allows you to select the power-on state for the NumLock.

Configuration options: [Off] [On]

### PS/2 Mouse Support [Auto]

Allows you to enable or disable support for PS/2 mouse.

Configuration options: [Disabled] [Enabled] [Auto]

### Wait for 'F1' If Error [Enabled]

When set to Enabled, the system waits for the F1 key to be pressed when error occurs. Configuration options: [Disabled] [Enabled]

### Hit 'DEL' Message Display [Enabled]

When set to Enabled, the system displays the message "Press DEL to run Setup" during POST. Configuration options: [Disabled] [Enabled]

## Interrupt 19 Capture [Disabled]

When set to [Enabled], this function allows the option ROMs to trap Interrupt 19. Configuration options: [Disabled] [Enabled]

### 2.6.4 Security

The Security menu items allow you to change the system security settings. Select an item then press <Enter> to display the configuration options.

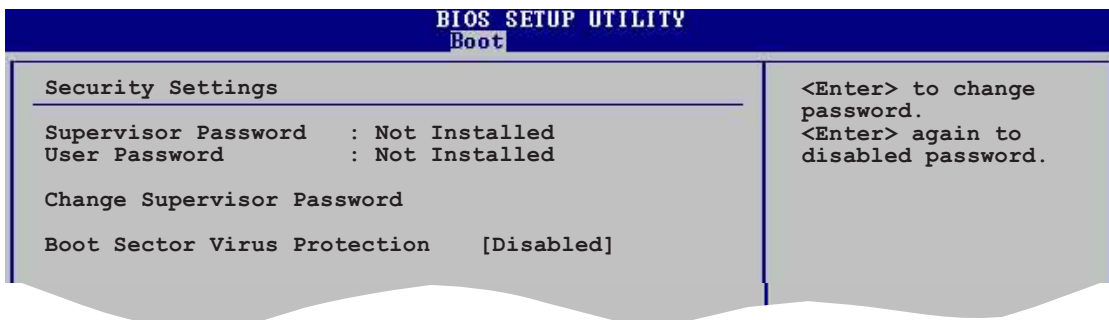

### Change Supervisor Password

Select this item to set or change the supervisor password. The Supervisor Password item on top of the screen shows the default **Not Installed**. After you set a password, this item shows **Installed**.

To set a Supervisor Password:

1. Select the Change Supervisor Password item and press <Enter>.
2. From the password box, type a password composed of at least six letters and/or numbers, then press <Enter>.
3. Confirm the password when prompted.

The message "Password Installed" appears after you successfully set your password.

To change the supervisor password, follow the same steps as in setting a user password.

To clear the supervisor password, select the Change Supervisor Password then press <Enter>. The message "Password Uninstalled" appears.



---

If you forget your BIOS password, you can clear it by erasing the CMOS Real Time Clock (RTC) RAM. See section "1.9 Jumpers" for information on how to erase the RTC RAM.

---

After you have set a supervisor password, the other items appear to allow you to change other security settings.

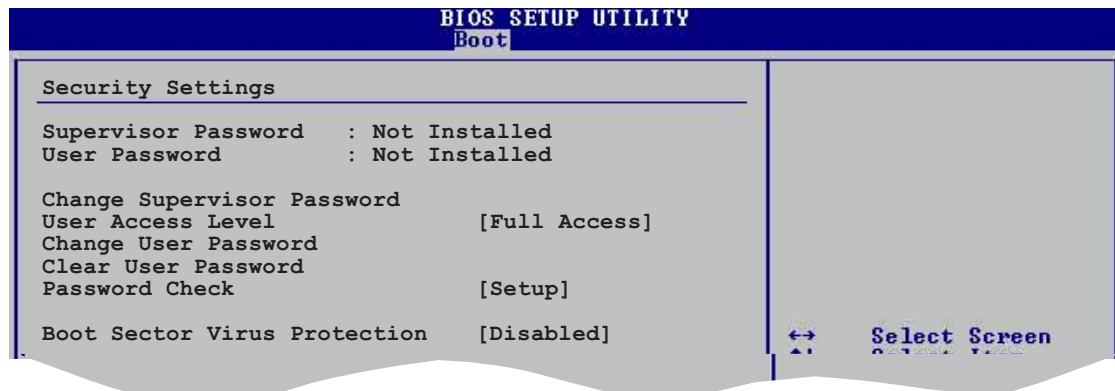

## User Access Level (Full Access]

This item allows you to select the access restriction to the Setup items. Configuration options: [No Access] [View Only] [Limited] [Full Access]

**No Access** prevents user access to the Setup utility.

**View Only** allows access but does not allow change to any field.

**Limited** allows changes only to selected fields, such as Date and Time.

**Full Access** allows viewing and changing all the fields in the Setup utility.

## Change User Password

Select this item to set or change the user password. The User Password item on top of the screen shows the default **Not Installed**. After you set a password, this item shows **Installed**.

To set a User Password:

1. Select the Change User Password item and press <Enter>.
2. On the password box that appears, type a password composed of at least six letters and/or numbers, then press <Enter>.
3. Confirm the password when prompted.

The message “Password Installed” appears after you set your password successfully.

To change the user password, follow the same steps as in setting a user password.

## Clear User Password

Select this item to clear the user password.

## Password Check [Setup]

When set to [Setup], BIOS checks for user password when accessing the Setup utility. When set to [Always], BIOS checks for user password both when accessing Setup and booting the system.

Configuration options: [Setup] [Always]

## Boot Sector Virus Protection [Disabled]

Allows you to enable or disable the boot sector virus protection. Make sure to install Windows® XP Service Pack 2 or Windows® 2003 Service Pack 1 or later to use this feature. Configuration options: [Disabled] [Enabled]

## 2.7 Exit menu

The Exit menu items allow you to load the optimal or failsafe default values for the BIOS items, and save or discard your changes to the BIOS items.

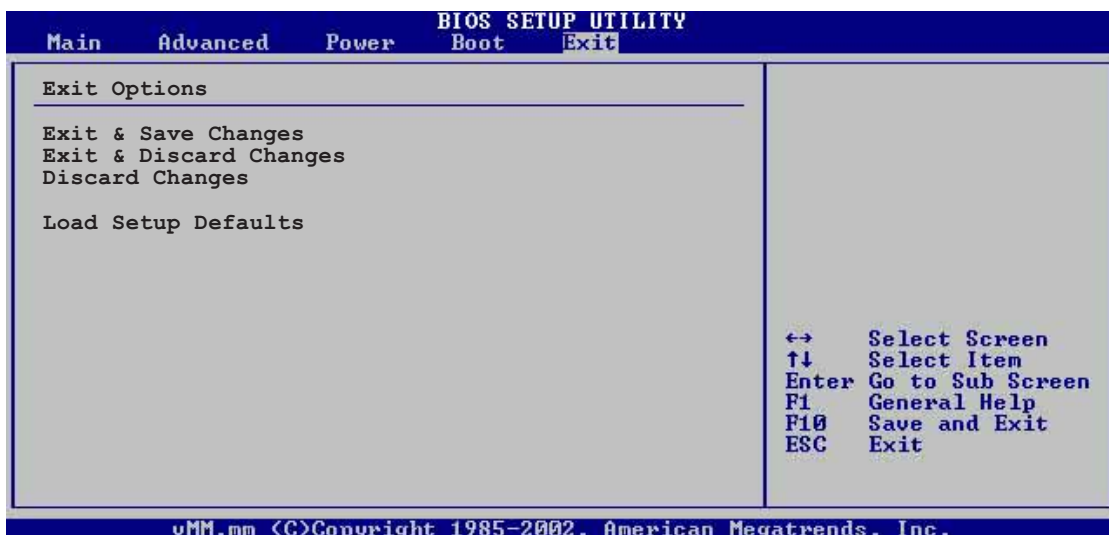

Pressing <Esc> does not immediately exit this menu. Select one of the options from this menu or <F10> from the legend bar to exit.

### Exit & Save Changes

Once you are finished making your selections, choose this option from the Exit menu to ensure the values you selected are saved to the CMOS RAM. An onboard backup battery sustains the CMOS RAM so it stays on even when the PC is turned off. When you select this option, a confirmation window appears. Select **Yes** to save changes and exit.



---

If you attempt to exit the Setup program without saving your changes, the program prompts you with a message asking if you want to save your changes before exiting. Press <Enter> to save the changes while exiting.

---

## **Exit & Discard Changes**

Select this option only if you do not want to save the changes that you made to the Setup program. If you made changes to fields other than System Date, System Time, and Password, the BIOS asks for a confirmation before exiting.

## **Discard Changes**

This option allows you to discard the selections you made and restore the previously saved values. After selecting this option, a confirmation appears. Select **Yes** to discard any changes and load the previously saved values.

## **Load Setup Defaults**

This option allows you to load the default values for each of the parameters on the Setup menus. When you select this option or if you press <F5>, a confirmation window appears. Select **Yes** to load default values. Select **Exit & Save Changes** or make other changes before saving the values to the non-volatile RAM.



This chapter describes the contents of the support CD that comes with the motherboard package.

# Software support

A large, light gray, stylized number '3' is positioned behind the word 'Software' in the title.

## 3.1 Installing an operating system

This motherboard supports Windows® 98SE/ME/2000/XP/2003 Server operating systems (OS). Always install the latest OS version and corresponding updates to maximize the features of your hardware.



- Motherboard settings and hardware options vary. Use the setup procedures presented in this chapter for reference only. Refer to your OS documentation for detailed information.
- Make sure that you install Windows® 2000 Service Pack 4 or the Windows® XP Service Pack 1 or later versions before installing the drivers for better compatibility and system stability.

## 3.2 Support CD information

The support CD that came with the motherboard package contains the drivers, software applications, and utilities that you can install to avail all motherboard features.



The contents of the support CD are subject to change at any time without notice. Visit the ASUS website([www.asus.com](http://www.asus.com)) for updates.

### 3.2.1 Running the support CD

Place the support CD to the optical drive. The CD automatically displays the **Drivers** menu if Autorun is enabled in your computer.

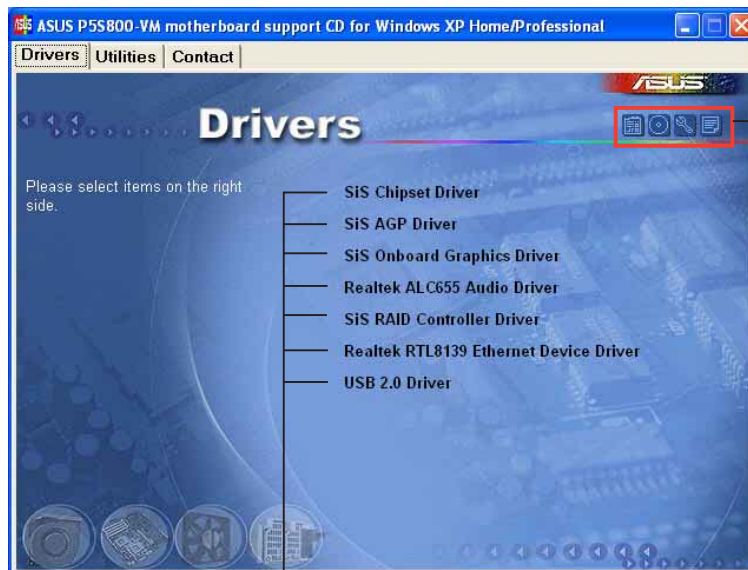

Click an icon to display support CD/motherboard information

Click an item to install



If **Autorun** is NOT enabled in your computer, browse the contents of the support CD to locate the file **ASSETUP.EXE** from the BIN folder. Double-click the **ASSETUP.EXE** to run the CD.



## 3.2.2 Drivers menu

The drivers menu shows the available device drivers if the system detects installed devices. Install the necessary drivers to activate the devices.

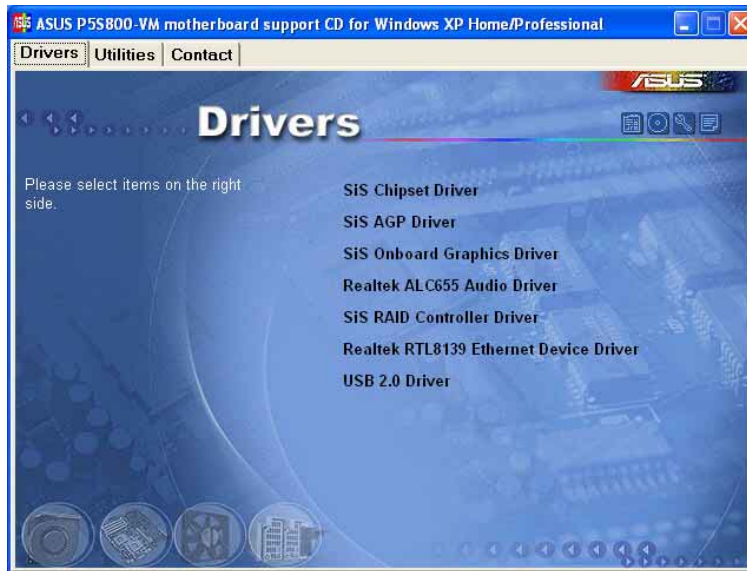

### **SiS Chipset Driver**

Installs the SiS Chipset driver. When installed to the target system, this driver provides the method for configuring the chipset components.

### **SiS AGP Driver**

Installs the SiS AGP driver.

### **SiS Onboard Graphics Driver**

Installs the onboard SiS graphics driver.

### **Realtek ALC655 Audio Driver**

Executes the wizard to install the Realtek® ALC655 audio driver and application.

### **SiS RAID Controller Driver**

Installs the SiS RAID controller driver.

### **Realtek RTL8139 Ethernet Device Driver**

Installs the Realtek® RTL8139 Ethernet device driver.

### **USB 2.0 Driver**

Installs the USB 2.0 driver.

### 3.2.3 Utilities menu

The Utilities menu shows the applications and other software that the motherboard supports.

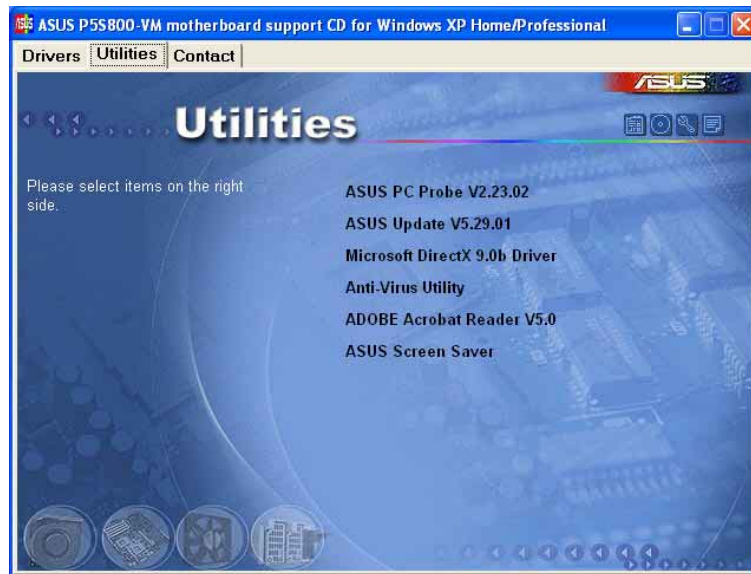

#### **ASUS PC Probe**

This smart utility monitors the fan speed, CPU temperature, and system voltages, and alerts you of any detected problems. This utility helps you keep your computer in healthy operating condition.

#### **ASUS Update**

The ASUS Update utility allows you to update the motherboard BIOS in a Windows® environment. This utility requires an Internet connection either through a network or an Internet Service Provider (ISP). See page 2-8 for details.

#### **Microsoft DirectX**

Installs the Microsoft® DirectX 9.0b driver.

#### **Anti-Virus Utility**

Installs the PC-cillin anti-virus program. View the online help for detailed information.

#### **ADOBE Acrobat Reader**

Installs the Adobe® Acrobat® Reader V5.0.

#### **ASUS Screen Saver**

Installs the ASUS screen saver.

### 3.2.4 ASUS Contact information

Click the **Contact** tab to display the ASUS contact information. You can also find this information on the inside front cover of this user guide.

