



# *P4SP-MX SE*

User Guide

# Motherboard

**E1676**

**First Edition V1**

**July 2004**

**Copyright © 2004 ASUSTeK COMPUTER INC. All Rights Reserved.**

No part of this manual, including the products and software described in it, may be reproduced, transmitted, transcribed, stored in a retrieval system, or translated into any language in any form or by any means, except documentation kept by the purchaser for backup purposes, without the express written permission of ASUSTeK COMPUTER INC. ("ASUS").

Product warranty or service will not be extended if: (1) the product is repaired, modified or altered, unless such repair, modification or alteration is authorized in writing by ASUS; or (2) the serial number of the product is defaced or missing.

ASUS PROVIDES THIS MANUAL "AS IS" WITHOUT WARRANTY OF ANY KIND, EITHER EXPRESS OR IMPLIED, INCLUDING BUT NOT LIMITED TO THE IMPLIED WARRANTIES OR CONDITIONS OF MERCHANTABILITY OR FITNESS FOR A PARTICULAR PURPOSE. IN NO EVENT SHALL ASUS, ITS DIRECTORS, OFFICERS, EMPLOYEES OR AGENTS BE LIABLE FOR ANY INDIRECT, SPECIAL, INCIDENTAL, OR CONSEQUENTIAL DAMAGES (INCLUDING DAMAGES FOR LOSS OF PROFITS, LOSS OF BUSINESS, LOSS OF USE OR DATA, INTERRUPTION OF BUSINESS AND THE LIKE), EVEN IF ASUS HAS BEEN ADVISED OF THE POSSIBILITY OF SUCH DAMAGES ARISING FROM ANY DEFECT OR ERROR IN THIS MANUAL OR PRODUCT.

SPECIFICATIONS AND INFORMATION CONTAINED IN THIS MANUAL ARE FURNISHED FOR INFORMATIONAL USE ONLY, AND ARE SUBJECT TO CHANGE AT ANY TIME WITHOUT NOTICE, AND SHOULD NOT BE CONSTRUED AS A COMMITMENT BY ASUS. ASUS ASSUMES NO RESPONSIBILITY OR LIABILITY FOR ANY ERRORS OR INACCURACIES THAT MAY APPEAR IN THIS MANUAL, INCLUDING THE PRODUCTS AND SOFTWARE DESCRIBED IN IT.

Products and corporate names appearing in this manual may or may not be registered trademarks or copyrights of their respective companies, and are used only for identification or explanation and to the owners' benefit, without intent to infringe.

# Contents

Notices .....	v
Safety information .....	vi
P4SP-MX SE specification summary .....	vii
About this guide .....	viii

## Chapter 1: Product introduction

1.1 Welcome! .....	1-2
1.2 Package contents .....	1-2
1.3 Special features .....	1-2
1.3.1 Product highlights .....	1-2
1.3.2 ASUS unique features .....	1-4
1.4 Before you proceed .....	1-5
1.5 Motherboard overview .....	1-6
1.5.1 Motherboard layout .....	1-6
1.5.2 Placement direction .....	1-7
1.5.3 Screw holes .....	1-7
1.6 Central Processing Unit (CPU) .....	1-8
1.6.1 Overview .....	1-8
1.6.2 Installing the CPU .....	1-9
1.7 System memory .....	1-10
1.7.1 DIMM sockets location .....	1-10
1.7.2 Memory configurations .....	1-10
1.7.3 Installing a DIMM .....	1-11
1.7.4 Removing a DIMM .....	1-11
1.8 Expansion slots .....	1-12
1.8.1 Installing an expansion card .....	1-12
1.8.2 Configuring an expansion card .....	1-12
1.8.3 PCI slots .....	1-14
1.8.4 AGP slot .....	1-14
1.9 Jumpers .....	1-15
1.10 Connectors .....	1-17
1.10.1 Rear panel connectors .....	1-17
1.10.2 Internal connectors .....	1-18

# Contents

## Chapter 2: BIOS information

2.1	Managing and updating your BIOS .....	2-2
2.1.1	Creating a bootable floppy disk .....	2-2
2.1.2	Using ASUS EZ Flash to update the BIOS .....	2-3
2.1.3	Using the AFLASH utility .....	2-4
2.1.4	Recovering the BIOS with CrashFree BIOS .....	2-6
2.1.5	ASUS Update .....	2-7
2.2	BIOS Setup program .....	2-9
2.2.1	BIOS menu bar .....	2-9
2.2.2	Legend bar .....	2-10
2.3	Main menu .....	2-11
2.3.1	Primary and Secondary Master/Slave .....	2-13
2.3.2	Keyboard Features .....	2-15
2.4	Advanced menu .....	2-16
2.4.1	Chip Configuration .....	2-18
2.4.2	I/O Device Configuration .....	2-20
2.4.3	PCI Configuration .....	2-21
2.5	Power menu .....	2-23
2.5.1	Power Up Control .....	2-24
2.5.2	Hardware Monitor .....	2-25
2.6	Boot menu .....	2-26
2.7	Exit menu .....	2-28

## Chapter 3: Software support

3.1	Install an operating system .....	3-2
3.2	Support CD information .....	3-2
3.2.1	Running the support CD .....	3-2
3.2.2	Installation items .....	3-3

# Notices

## Federal Communications Commission Statement

This device complies with FCC Rules Part 15. Operation is subject to the following two conditions:

- This device may not cause harmful interference, and
- This device must accept any interference received including interference that may cause undesired operation.

This equipment has been tested and found to comply with the limits for a Class B digital device, pursuant to Part 15 of the FCC Rules. These limits are designed to provide reasonable protection against harmful interference in a residential installation. This equipment generates, uses and can radiate radio frequency energy and, if not installed and used in accordance with manufacturer's instructions, may cause harmful interference to radio communications. However, there is no guarantee that interference will not occur in a particular installation. If this equipment does cause harmful interference to radio or television reception, which can be determined by turning the equipment off and on, the user is encouraged to try to correct the interference by one or more of the following measures:

- Reorient or relocate the receiving antenna.
- Increase the separation between the equipment and receiver.
- Connect the equipment to an outlet on a circuit different from that to which the receiver is connected.
- Consult the dealer or an experienced radio/TV technician for help.



---

The use of shielded cables for connection of the monitor to the graphics card is required to assure compliance with FCC regulations. Changes or modifications to this unit not expressly approved by the party responsible for compliance could void the user's authority to operate this equipment.

---

## Canadian Department of Communications Statement

This digital apparatus does not exceed the Class B limits for radio noise emissions from digital apparatus set out in the Radio Interference Regulations of the Canadian Department of Communications.

**This class B digital apparatus complies with Canadian ICES-003.**

# Safety information

## Electrical safety

- To prevent electrical shock hazard, disconnect the power cable from the electrical outlet before relocating the system.
- When adding or removing devices to or from the system, ensure that the power cables for the devices are unplugged before the signal cables are connected. If possible, disconnect all power cables from the existing system before you add a device.
- Before connecting or removing signal cables from the motherboard, ensure that all power cables are unplugged.
- Seek professional assistance before using an adapter or extension cord. These devices could interrupt the grounding circuit.
- Make sure that your power supply is set to the correct voltage in your area. If you are not sure about the voltage of the electrical outlet you are using, contact your local power company.
- If the power supply is broken, do not try to fix it by yourself. Contact a qualified service technician or your retailer.

## Operation safety

- Before installing the motherboard and adding devices on it, carefully read all the manuals that came with the package.
- Before using the product, make sure all cables are correctly connected and the power cables are not damaged. If you detect any damage, contact your dealer immediately.
- To avoid short circuits, keep paper clips, screws, and staples away from connectors, slots, sockets and circuitry.
- Avoid dust, humidity, and temperature extremes. Do not place the product in any area where it may become wet.
- Place the product on a stable surface.
- If you encounter technical problems with the product, contact a qualified service technician or your retailer.

# P4SP-MX SE specification summary\*

<b>CPU</b>	Socket 478 for Intel® Pentium® 4/Celeron processor Intel® Hyper-Threading technology ready New power design for next generation Intel® Prescott CPU
<b>Chipset</b>	SiS651 Northbridge SiS962L Southbridge
<b>Front Side Bus (FSB)</b>	533/400MHz
<b>Memory</b>	2 x 184-pin DDR DIMM sockets for up to 2GB memory Supports PC2700/2100/1600 unbuffered non-ECC DDR DIMMs.
<b>Expansion slots</b>	1 x AGP 4X (1.5V only) 3 x PCI
<b>VGA</b>	Integrated 3D graphics controller in SiS 651 chip
<b>Storage</b>	2 x UltraDMA133, PIO Mode 0 ~ 4
<b>Audio</b>	ADI AD1888 6-channel audio CODEC
<b>LAN</b>	SiS962L integrated 10/100 Mbps Fast Ethernet with Realtek external PHY
<b>Special features</b>	Power loss restart Digital audio via an S/PDIF out interface
<b>Rear panel I/O</b>	1 x Parallel port 1 x S/PDIF out port 1 x Video port 1 x PS/2 keyboard port 1 x PS/2 mouse port 1 x RJ-45 port 4 x USB 2.0/USB 1.1 ports Line In/Line Out/Microphone ports
<b>Internal I/O</b>	USB 2.0 connector for two additional USB ports CPU and chassis fan connectors 20-pin/4-pin ATX 12V power connectors CD/AUX audio connectors GAME/MIDI connector Front panel audio connector Serial (COM1) connector Panel connector
<b>BIOS features</b>	2Mb Flash ROM, DMI 2.0, Award BIOS. TCAV PnP features, SM BIOS 2.3, WfM 2.0, ASUS CrashFree BIOS, ASUS EZ Flash

\* Specifications are subject to change without notice.

(Continued on the next page.)

# P4SP-MX SE specification summary

<b>Industry standard</b>	PCI 2.2, USB 2.0/1.1
<b>Manageability</b>	WOL/WOR by PME, DMI 2.0, WfM 2.0
<b>Form Factor</b>	Micro-ATX form factor: 9.6 in x 9.6 in (24.5 cm x 24.5 cm)
<b>Support CD contents</b>	Device drivers ASUS PC Probe ASUS LiveUpdate ASUS Screensaver Adobe Acrobat Reader Trend Micro™ PC-cillin 2002 anti-virus software Microsoft® DirectX 9.0

## About this guide

### Conventions used in this guide

To make sure that you perform certain tasks properly, take note of the following symbols used throughout this guide.



**WARNING:** Information to prevent injury to yourself when trying to complete a task.



**CAUTION:** Information to prevent damage to the components when trying to complete a task.



**IMPORTANT:** Information that you **MUST** follow to complete a task.



**NOTE:** Tips and additional information to aid in completing a task.



# ***Chapter 1***

This chapter describes the features of the motherboard. It includes brief descriptions of the motherboard components, and illustrations of the layout, jumper settings, and connectors.

## **Product introduction**

# 1.1 Welcome!

**Thank you for buying the ASUS® P4SP-MX SE motherboard!**

The ASUS P4SP-MX SE motherboard delivers a host of new features and latest technologies making it another standout in the long line of ASUS quality motherboards!

Before you start installing the motherboard, and hardware devices on it, check the items in your package with the list below.

## 1.2 Package contents

Check your P4SP-MX SE package for the following items.

- ✓ ASUS P4SP-MX SE motherboard  
Micro-ATX form factor: 9.6 in x 9.6 in (24.5 cm x 24.5 cm)
- ✓ ASUS P4SP-MX SE series support CD
- ✓ 9-pin COM cable
- ✓ 80-conductor UltraDMA cable
- ✓ Ribbon cable for a 3.5-inch floppy drive
- ✓ I/O shield
- ✓ Bag of extra jumper caps
- ✓ User Guide



---

If any of the above items is damaged or missing, contact your retailer.

---

## 1.3 Special features

### 1.3.1 Product highlights

#### Intel® Prescott CPU support

The motherboard comes with a 478-pin surface mount, Zero Insertion Force (ZIF) socket for the Intel® Pentium® 4 processor and 512/256KB L2 cache on 0.13 micron process. This motherboard supports 533/400 MHz system front side bus that allows 4.3GB/s and 3.2GB/s data transfer rates, respectively. The P4SP-MX SE also supports the next-generation Intel® Prescott CPU and the Intel® Hyper-Threading Technology. **See page 1-8.**

#### SiS651/962L chipset



Embedded in this motherboard is the SiS651/962L chipset that integrates various SiS-developed technologies to ensure an efficient and reliable computing performance.

The SiS651 Northbridge chip is a high performance Host Memory Controller for the Intel® Pentium® 4 processor, and supports a 2D/3D graphic engine, memory controller, AGP 4X, and 533MHz front side bus. The SiS651 interconnects with the SiS962L Southbridge chip at speeds of up to 533MB/s using the proprietary SiS MuTIOL® technology.

Providing I/O and peripheral support is the SiS962L MuTIOL® Media I/O. The Southbridge is a subsystem that integrates various I/O functions including dual-channel DMA133 bus master IDE, USB 2.0/1.1, Ethernet, and audio controllers. The SiS962L provides the necessary interfaces for the LPC, AC'97 audio/modem devices, and complies with the Advanced Power Management (APM) 1.2 and ACPI 1.0b specification.

### **Integrated 2D/3D graphic engine**

Embedded in the Northbridge is an integrated graphic engine with a 256-bit 3D and 2D graphics accelerator with maximum 64MB shared display memory.

**See page 2-19.**

### **Integrated 10/100 Mbps LAN controller**

The SiS651 Northbridge provides an integrated Fast Ethernet solution that fully supports 10BASE-T/100BASE-TX networking. The integrated controller works with the onboard Realtek LAN PHY to give you faster Internet and LAN connections.

**See page 1-17.**

### **SoundMAX digital audio system**

The SoundMax Digital Audio System is the industry's highest performance and most reliable audio solution for business professionals, audiophiles, musicians, and gamers. SoundMAX Digital Audio System can output 5.1 channel surround and features state-of-the-art DLS2 MIDI synthesizer with Yamaha DLSbyXG sound set, 5.1 Virtual Theater™ and supports all major game audio technologies including Microsoft DirectX™8.0, Microsoft DirectSound 3D™, A3D, MacroFX, ZoomFX, MultiDrive 5.1 and EAX. **See page 1-17.**

### **USB 2.0 connectivity**

The motherboard rear panel is equipped with four (4) Universal Serial Bus (USB) ports to connect USB 2.0 devices. A USB header is also available at mid-board to accommodate a USB module for two (2) additional USB ports. The USB ports and header comply with USB 2.0 specification that supports up to 480 Mbps connection speed. This speed advantage over the conventional USB 1.1 (12 Mbps) allows faster Internet connection, interactive gaming, and simultaneous running of high-speed peripherals. USB 2.0 is backward compatible with USB 1.1.

**See pages 1-17 and 1-20.**

## 1.3.2 ASUS unique features

### ASUS CrashFree BIOS



CrashFree BIOS allows users to restore BIOS data from a floppy diskette even when BIOS code and data are corrupted during upgrade or invaded by a virus. Unlike other competing vendors' products, ASUS motherboards now enable users to enjoy this protection feature without the need to pay for an optional ROM.

**See page 2-6.**

### ASUS EZ Flash BIOS



With the ASUS EZ Flash, you can easily update the system BIOS even before loading the operating system. No need to use a DOS-based utility or boot from a floppy disk. **See page 2-3.**

## 1.4 Before you proceed

Take note of the following precautions before you install motherboard components or change any motherboard settings.



- Unplug the power cord from the wall socket before touching any component.
- Use a grounded wrist strap or touch a safely grounded object or to a metal object, such as the power supply case, before handling components to avoid damaging them due to static electricity.
- Hold components by the edges to avoid touching the ICs on them.
- Whenever you uninstall any component, place it on a grounded antistatic pad or in the bag that came with the component.
- **Before you install or remove any component, ensure that the ATX power supply is switched off or the power cord is detached from the power supply.** Failure to do so may cause severe damage to the motherboard, peripherals, and/or components.

## Onboard LED

The motherboard comes with a stand-by power LED. When lit, the green LED indicates that the system is ON, in sleep mode, or in soft-off mode, a reminder that you should shut down the system and unplug the power cable before removing or plugging in any motherboard component. The illustration below shows the location of the onboard LED.

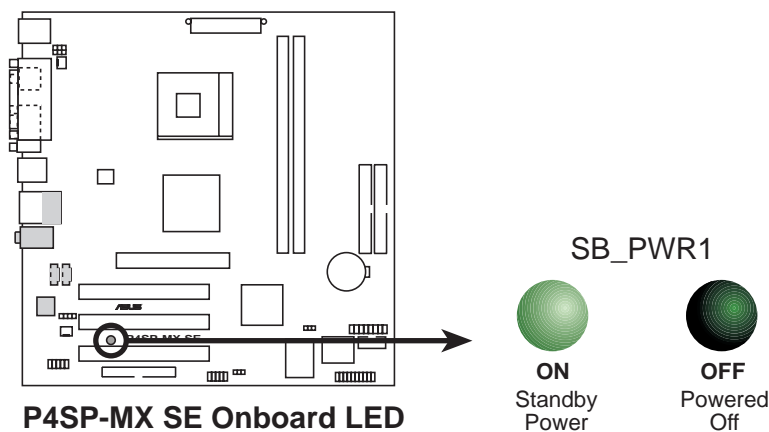

# 1.5 Motherboard overview

## 1.5.1 Motherboard layout

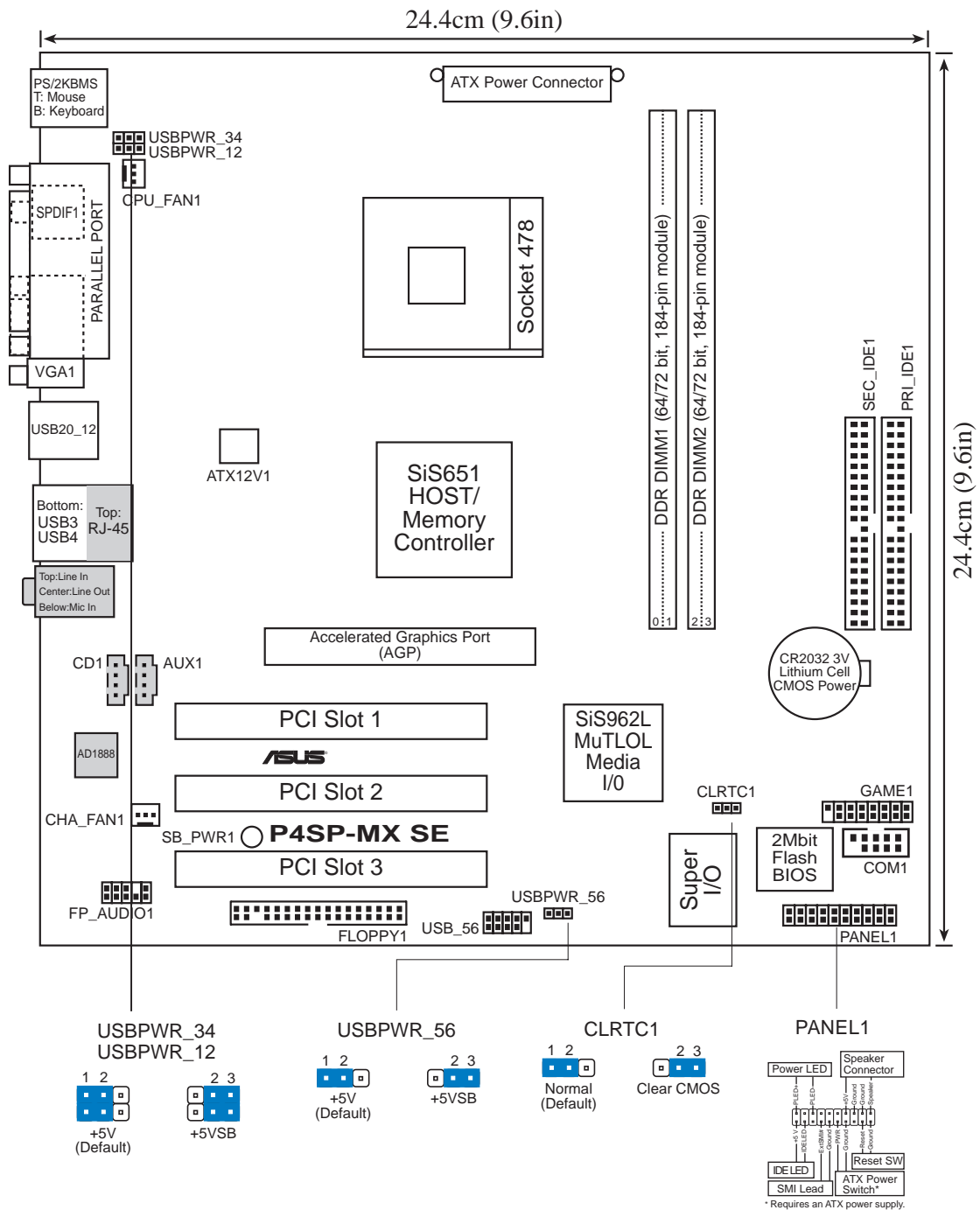

## 1.5.2 Placement direction

When installing the motherboard, make sure that you place it into the chassis in the correct orientation. The edge with external ports goes to the rear part of the chassis as indicated in the image below.

## 1.5.3 Screw holes

Place eight (8) screws into the holes indicated by circles to secure the motherboard to the chassis.



---

Do not overtighten the screws! Doing so may damage the motherboard.

---

Place this side towards  
the rear of the chassis

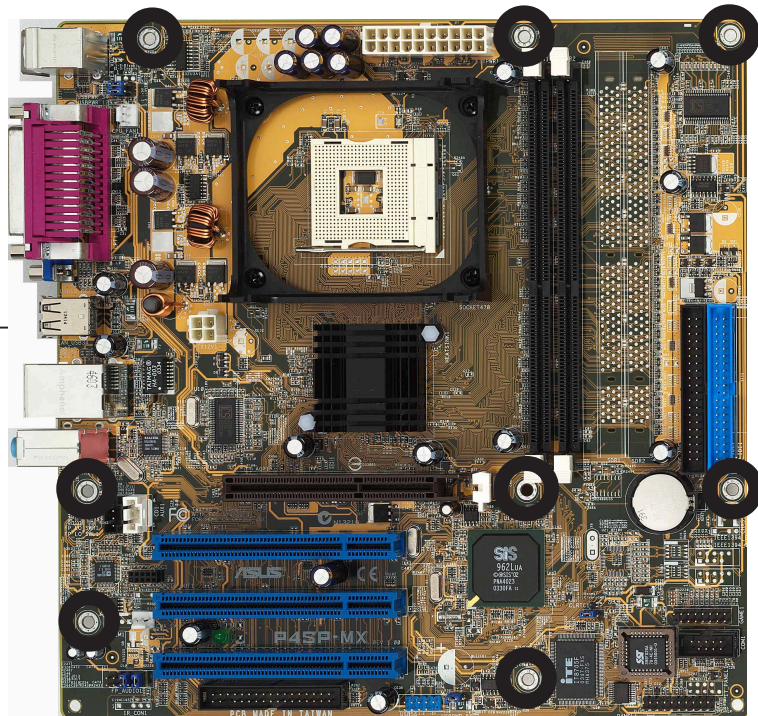

# 1.6 Central Processing Unit (CPU)

## 1.6.1 Overview

The Intel® Pentium® 4 processor has a gold triangular mark on one corner. This mark indicates the processor Pin 1 that should match a specific corner of the CPU socket.

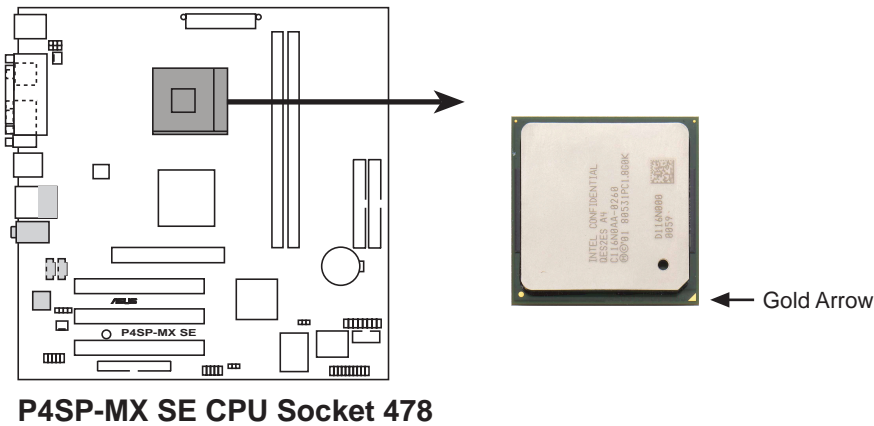

Incorrect installation of the CPU into the socket may bend the pins and severely damage the CPU!

## Notes on Intel® Hyper-Threading Technology



- Hyper-Threading Technology is supported under **Windows XP** and **Linux 2.4.x (kernel)** and later versions only. Under Linux, use the Hyper-Threading compiler to compile the code. If you are using any other operating systems, disable the Hyper-Threading Technology item in BIOS to ensure system stability and performance.
- It is recommended that you install WinXP Service Pack 1.
- Make sure to enable the Hyper-Threading Technology item in BIOS before installing a supported operating system.
- For more information on Hyper-Threading Technology, visit [www.intel.com/info/hyperthreading](http://www.intel.com/info/hyperthreading).



## 1.6.2 Installing the CPU

Follow these steps to install a CPU.

1. Locate the 478-pin ZIF socket on the motherboard.
2. Unlock the socket by pressing the lever sideways, then lift it up to a 90°-100° angle.



Make sure that the socket lever is lifted up to 90°-100° angle, otherwise the CPU does not fit in completely.

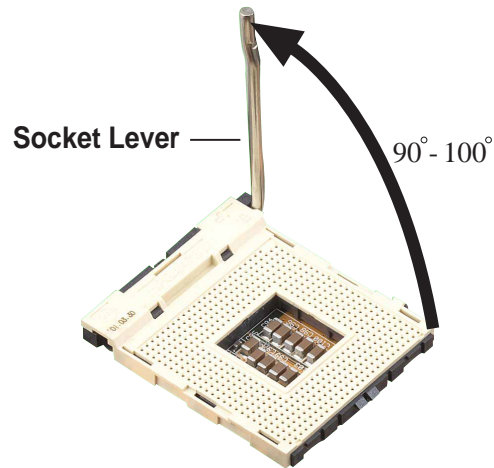

3. Position the CPU above the socket such that its marked corner matches the base of the socket lever.
4. Carefully insert the CPU into the socket until it fits in place.



The CPU fits only in one correct orientation. DO NOT force the CPU into the socket to prevent bending the pins and damaging the CPU!

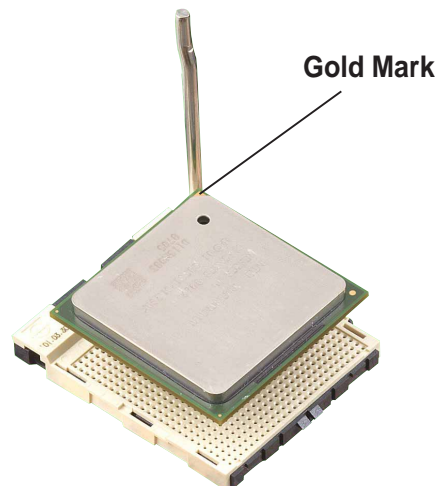

5. When the CPU is in place, push down the socket lever to secure the CPU. The lever clicks on the side tab to indicate that it is locked.
6. Install a CPU heatsink and fan following the instructions that came with the heatsink package.
7. Connect the CPU fan cable to the CPU\_FAN1 connector on the motherboard.



# 1.7 System memory

## 1.7.1 DIMM sockets location

The following figure illustrates the location of the DDR DIMM sockets.

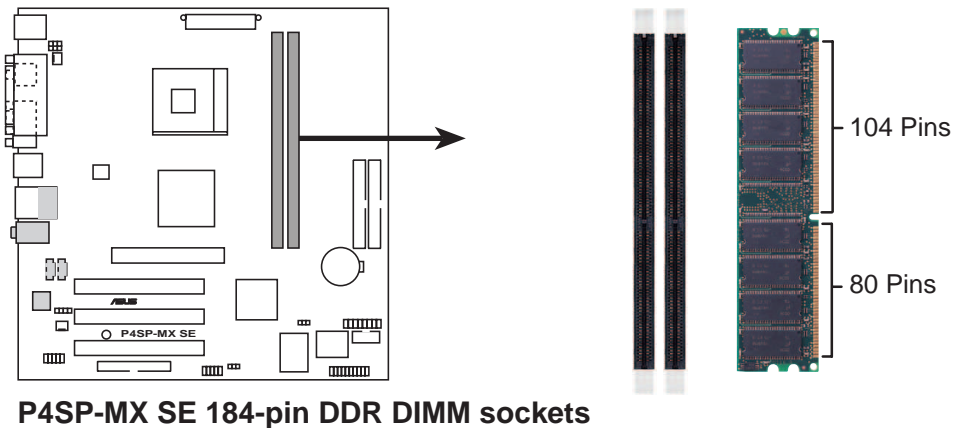

- Make sure to unplug the power supply before adding or removing DIMMs or other system components. Failure to do so may cause severe damage to both the motherboard and the components.
- When installing long AGP cards, it is recommended to install the memory modules first. Long AGP cards, when installed, may interfere with the memory sockets.

## 1.7.2 Memory configurations

You may install 64MB, 128MB, 256MB, 512MB, and 1GB DDR DIMMs into the DIMM sockets.

## 1.7.3 Installing a DIMM



Make sure to unplug the power supply before adding or removing DIMMs or other system components. Failure to do so may cause severe damage to both the motherboard and the components.

Follow these steps to install a DIMM.

1. Unlock a DIMM socket by pressing the retaining clips outward.
2. Align a DIMM on the socket such that the notch on the DIMM matches the break on the socket.



A DDR DIMM is keyed with a notch so that it fits in only one direction. DO NOT force a DIMM into a socket to avoid damaging the DIMM.

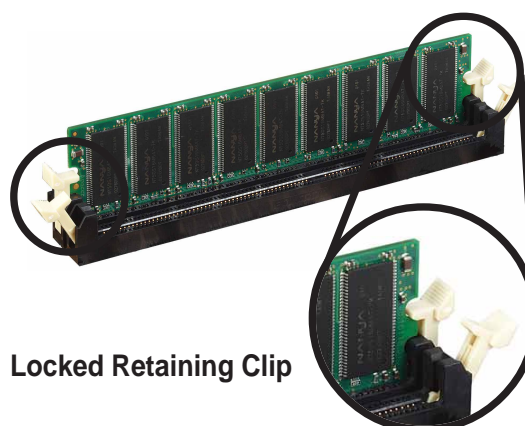
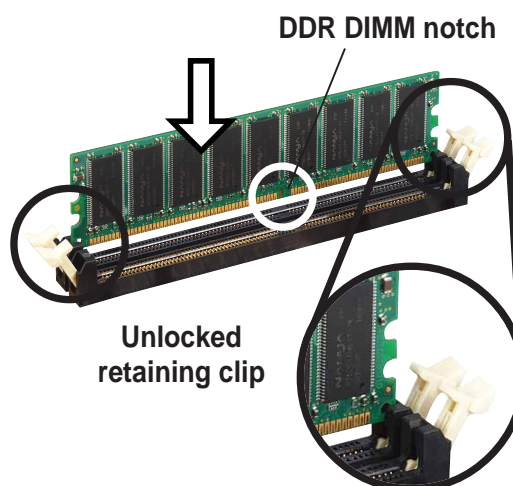

## 1.7.4 Removing a DIMM

Follow these steps to remove a DIMM.

1. Simultaneously press the retaining clips outward to unlock the DIMM.



Support the DIMM lightly with your fingers when pressing the retaining clips. The DIMM might get damaged when it flips out with extra force.

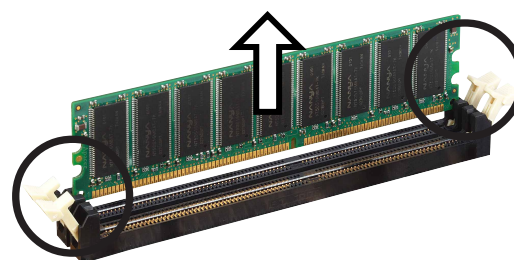

2. Remove the DIMM from the socket.

## 1.8 Expansion slots

In the future, you may need to install expansion cards. The following sub-sections describe the slots and the expansion cards that they support.



---

Make sure to unplug the power cord before adding or removing expansion cards. Failure to do so may cause you physical injury and damage motherboard components.

---

### 1.8.1 Installing an expansion card

Follow these steps to install an expansion card.

1. Before installing the expansion card, read the documentation that came with it and make the necessary hardware settings for the card.
2. Remove the system unit cover (if your motherboard is already installed in a chassis).
3. Remove the bracket opposite the slot that you intend to use. Keep the screw for later use.
4. Align the card connector with the slot and press firmly until the card is completely seated on the slot.
5. Secure the card to the chassis with the screw you removed earlier.
6. Replace the system cover.

### 1.8.2 Configuring an expansion card

After installing the expansion card, configure the it by adjusting the software settings.

1. Turn on the system and change the necessary BIOS settings, if any. See Chapter 2 for information on BIOS setup.
2. Assign an IRQ to the card. Refer to the tables on the next page.
3. Install the software drivers for the expansion card.

## Standard interrupt assignments

IRQ	Priority	Standard Function
0	1	System Timer
1	2	Keyboard Controller
2	N/A	Programmable Interrupt
3*	11	Communications Port (COM2)
4*	12	Communications Port (COM1)
5*	13	IRQ holder for PCI steering
6	14	Floppy Disk Controller
7*	15	Printer Port (LPT1)
8	3	System CMOS/Real Time Clock
9*	4	IRQ holder for PCI steering
10*	5	Advance AC'97 CODEC
11*	6	Standard PCI Graphics Adapter (VGA)
12*	7	PS/2 Compatible Mouse Port
13	8	Numeric Data Processor
14*	9	Primary IDE Channel
15*	10	Secondary IDE Channel

\* These IRQs are usually available for ISA or PCI devices.

## IRQ assignments for this motherboard

	A	B	C	D	E	F	G	H
PCI slot 1	—	used	—	—	—	—	—	—
PCI slot 2	—	—	shared	—	—	—	—	—
PCI slot 3	—	—	—	shared	—	—	—	—
AGP slot	shared	—	—	—	—	—	—	—
Onboard USB controller 1	—	—	—	—	used	—	—	—
Onboard USB controller 2	—	—	—	—	—	used	—	—
Onboard USB controller 3	—	—	—	—	—	—	used	—
Onboard USB 2.0 controller	—	—	—	—	—	—	—	used
Onboard LAN	—	—	—	shared	—	—	—	—
Onboard audio	—	—	shared	—	—	—	—	—
Onboard VGA	shared	—	—	—	—	—	—	—



When using PCI cards on shared slots, ensure that the drivers support “Share IRQ” or that the cards do not need IRQ assignments. Otherwise, conflicts will arise between the two PCI groups, making the system unstable and the card inoperable.

## 1.8.3 PCI slots

The PCI slots support PCI cards such as a LAN card, SCSI card, USB card, and other cards that comply with PCI specifications.

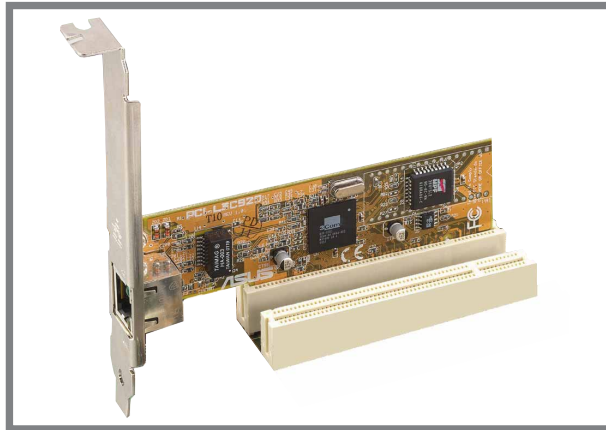

## 1.8.4 AGP slot

The Accelerated Graphics Port (AGP) slot that supports AGP 4X (+1.5V) cards. When you buy an AGP card, make sure that you ask for one with +1.5V specification.

Note the notches on the card golden fingers to ensure that they fit the AGP slot on the motherboard.



This motherboard does not support 3.3V AGP cards. Install only +1.5V AGP cards.

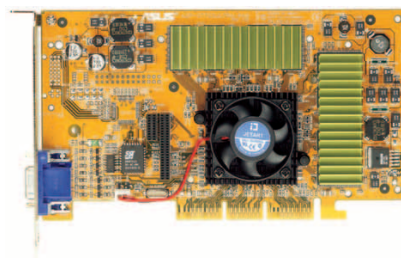
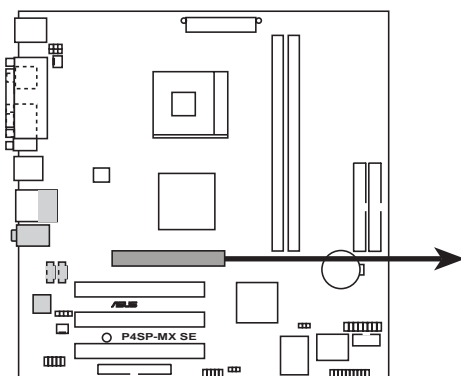

**P4SP-MX SE Accelerated Graphics Port (AGP )**

# 1.9 Jumpers

## 1. Clear RTC RAM (CLRRTC1)

This jumper allows you to clear the Real Time Clock (RTC) RAM in CMOS. You can clear the CMOS memory of date, time, and system setup parameters by erasing the CMOS RTC RAM data. The RAM data in CMOS, that include system setup information such as system passwords, is powered by the onboard button cell battery.

To erase the RTC RAM:

1. Turn OFF the computer and unplug the power cord.
2. Move the jumper cap from pins 1-2 (default) to pins 2-3. Keep the cap on pins 2-3 for about 5~10 seconds, then move the cap back to pins 1-2.
3. Plug the power cord and turn ON the computer.
4. Hold down the <Del> key during the boot process and enter BIOS setup to re-enter data.



Except when clearing the RTC RAM, never remove the cap on CLRRTC1 jumper default position. Removing the cap will cause system boot failure!

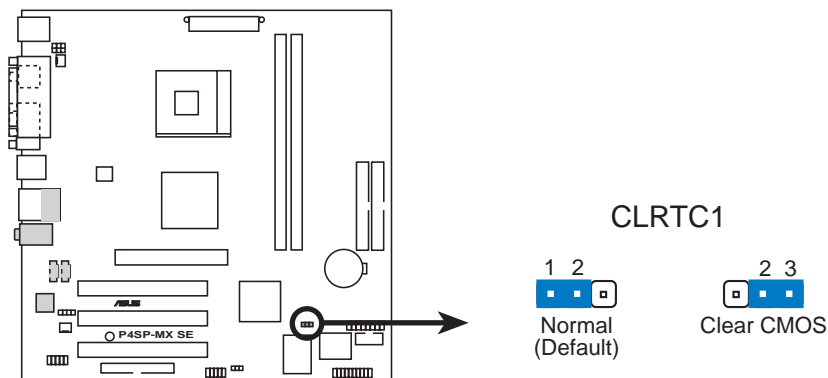

**P4SP-MX SE Clear RTC RAM setting**

## 2. USB device wake-up (3-pin USBPW12, USBPW34, USBPW56)

Set these jumpers to +5V to wake up the computer from S1 sleep mode (CPU stopped, DRAM refreshed, system running in low power mode) using the connected USB devices. Set to +5VSB to wake up from S3 sleep mode (no power to CPU, DRAM in slow refresh, power supply in reduced power mode). Both jumpers are set to pins 1-2 (+5V) by default because not all computers have the appropriate power supply to support this feature.

The USBPW\_12 and USBPW\_34 jumpers are for the rear USB ports. The USBPW\_56 jumper is for the internal USB header that you can connect to the front USB ports.



- This feature requires a power supply that can provide at least 1A on the +5VSB lead when these jumpers are set to +5VSB. Otherwise, the system would not power up.
- The total current consumed must NOT exceed the power supply capability (+5VSB) whether under normal condition or in sleep mode.

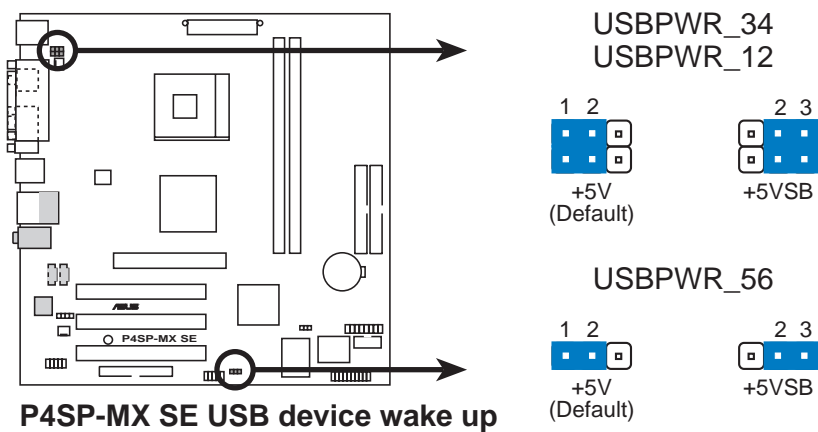



## 1.10 Connectors

This section describes and illustrates the motherboard rear panel and internal connectors.

### 1.10.1 Rear panel connectors

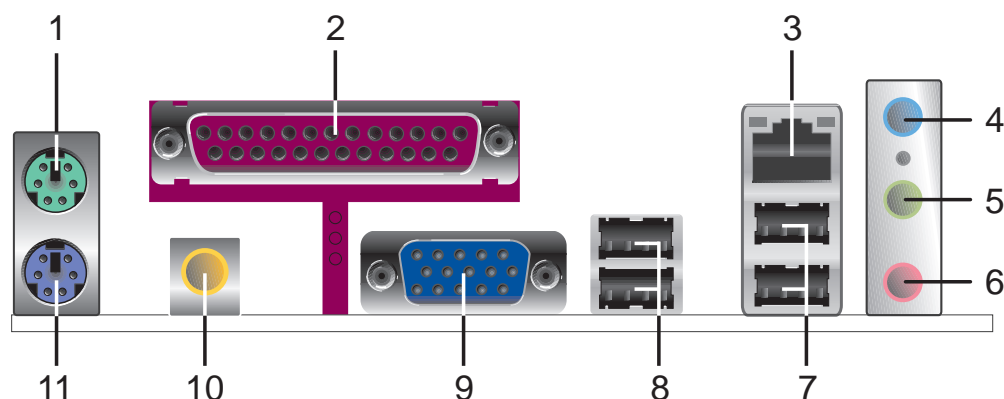

1. **PS/2 mouse port.** This green 6-pin connector is for a PS/2 mouse.
2. **Parallel port.** This 25-pin port connects a parallel printer, scanner, or other devices.
3. **RJ-45 port.** This port allows connection to a Local Area Network (LAN) through a network hub.
4. **Line In port.** This Line In (light blue) port connects a tape player or other audio sources. In 6-channel mode, the function of this port becomes Bass/Center.
5. **Line Out port.** This Line Out (lime) port connects a headphone or a speaker. In 4/6-channel mode, the function of this port becomes Front Speaker Out.
6. **Microphone port.** This Mic (pink) port connects a microphone. In 4/6-channel mode, the function of this port becomes Rear Speaker Out.



The functions of the Line Out, Line In, and Microphone ports change when you select the 4/6-channel audio configuration as shown in the following table.

#### Audio ports function variation

Port	Headphone /2-Speaker	4-Speaker	6-Speaker
Light Blue	Line In	Line In	Bass/Center
Lime	Line Out	Front Speaker Out	Front Speaker Out
Pink	Mic In	Rear Speaker Out	Rear Speaker Out



Windows® 98SE only supports 2-channel speaker configuration.

7. **USB 2.0 ports 3 and 4.** These two 4-pin Universal Serial Bus (USB) ports are available for connecting USB 2.0 devices.
8. **USB 2.0 ports 1 and 2.** These two 4-pin Universal Serial Bus (USB) ports are available for connecting USB 2.0 devices.
9. **VGA port.** This port connects a VGA compatible monitor.
10. **S/PDIF port.** This port connects S/PDIF devices that provide 6-channel surround sound and 3D audio.
11. **PS/2 keyboard port.** This purple connector is for a PS/2 keyboard.

## 1.10.2 Internal connectors

### 1. IDE connectors (40-1 pin PRI\_IDE1, SEC\_IDE1)

This connector supports the provided UltraDMA133 IDE hard disk ribbon cable. Connect the cable's blue connector to the primary (recommended) or secondary IDE connector, then connect the gray connector to the UltraDMA133 slave device (hard disk drive) and the black connector to the UltraDMA133 master device.



- Follow the hard disk drive documentation when setting the device in master or slave mode.
- Pin 20 on each IDE connector is removed to match the covered hole on the UltraDMA cable connector. This prevents incorrect orientation when you connect the cables.
- The hole near the blue connector on the UltraDMA cable is intentional.

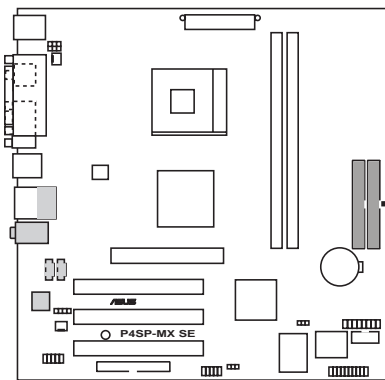

**P4SP-MX SE IDE connectors**

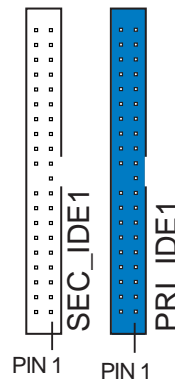

**NOTE:** Orient the red markings on the IDE ribbon cable to PIN 1

### 2. Floppy disk drive connector (34-1 pin FLOPPY1)

This connector supports the provided floppy drive ribbon cable. After connecting one end to the motherboard, connect the other end to the floppy drive. (Pin 5 is removed to prevent incorrect insertion when using ribbon cables with pin 5 plug).

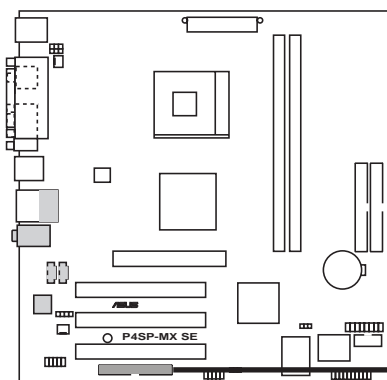

**P4SP-MX SE Floppy disk drive connector**

**FLOPPY1**



PIN 1

**NOTE:** Orient the red markings on the floppy ribbon cable to PIN 1.

### 3. ATX power connectors (20-pin ATXPWR1, 4-pin ATX12V1)

These connectors connect to an ATX 12V power supply. The plugs from the power supply are designed to fit these connectors in only one orientation. Find the proper orientation and push down firmly until the connectors completely fit.

In addition to the 20-pin ATXPWR connector, this motherboard requires that you connect the 4-pin ATX +12V power plug to provide sufficient power to the CPU.



Make sure that your ATX 12V power supply can provide 8A on the +12V lead and at least 1A on the +5-volt standby lead (+5VSB). The minimum recommended wattage is 230W, or 300W for a fully configured system. The system may become unstable and may experience difficulty powering up if the power supply is inadequate.

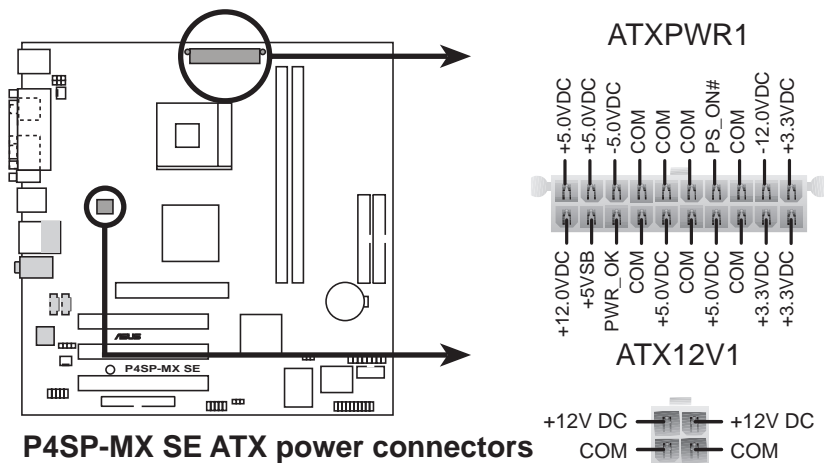

### 4. Front panel audio connector (10-1 pin FP\_AUDIO1)

This is an interface for the front panel cable that allows convenient connection and control of audio devices.

By default, the pins labeled LINE OUT\_R/BLINE\_OUT\_R and the pins LINE OUT\_L/BLINE\_OUT\_L are shorted with jumper caps. Remove the caps only when you are connecting the front panel audio cable.

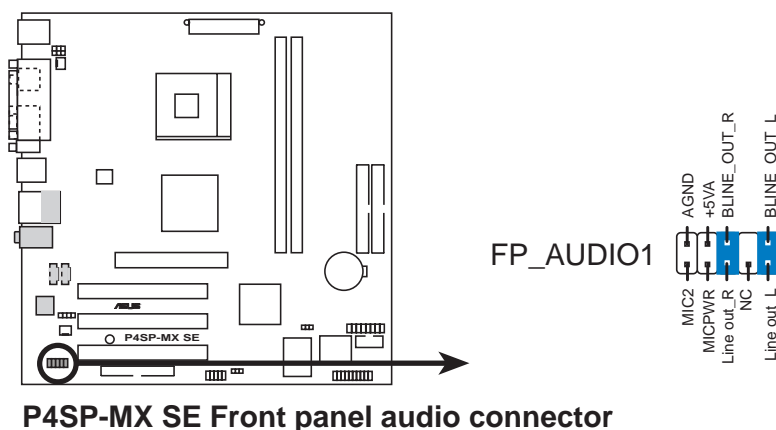

## 5. CPU and chassis fan connectors (3-pin CPU\_FAN1, CHA\_FAN1)

The fan connectors support cooling fans of 350mA~740mA (8.88W max.) or a total of 1A~2.22A (26.64W max.) at +12V. Connect the fan cables to the fan connectors on the motherboard, making sure that the black wire of each cable matches the ground pin of the connector.



Do not forget to connect the fan cables to the fan connectors. Lack of sufficient air flow within the system may damage the motherboard components. These are not jumpers! DO NOT place jumper caps on the fan connectors!

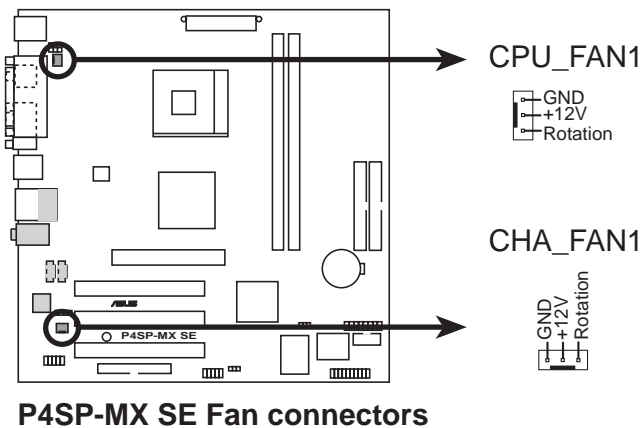

## 6. USB header (10-1 pin USB56)

If the USB ports on the rear panel are inadequate, a USB header is available for additional USB ports. Connect the USB cable of an optional USB 2.0 module to this header. You may install the USB module in the chassis front panel. The module has two USB 2.0 ports for connecting next generation USB peripherals such as high-resolution cameras, scanners, and printers.

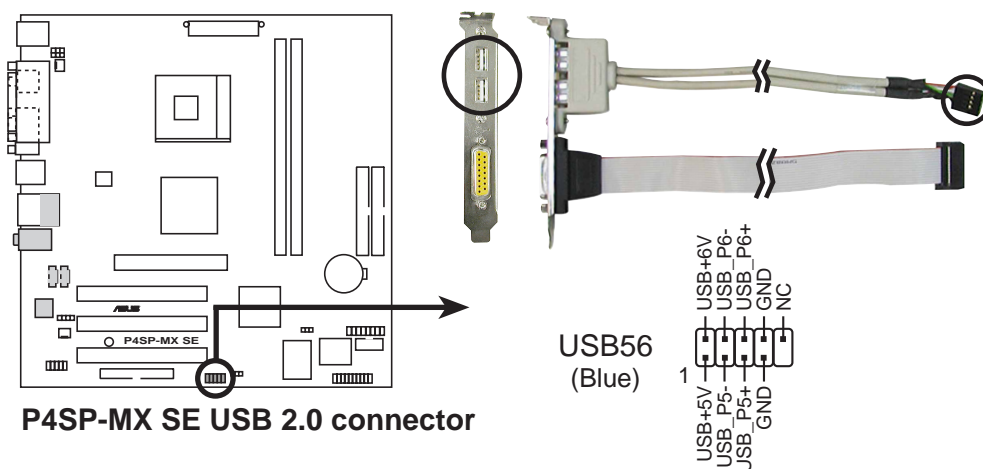

The USB module is purchased separately.

## 7. Internal audio connectors (4-pin AUX1, CD1)

These connectors allow you to receive stereo audio input from sound sources such as a CD-ROM, TV tuner, or MPEG card.

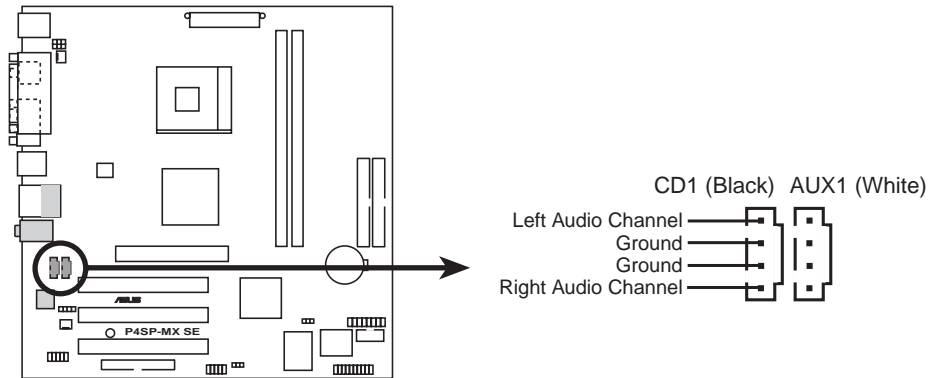

**P4SP-MX SE Internal audio connectors**

## 8. GAME/MIDI connector (16-1 pin GAME1)

This connector supports a GAME/MIDI module. Connect the GAME/MIDI cable with yellow connector to the yellow header onboard. The GAME/MIDI port on the module connects a joystick or a game pad for playing games, and MIDI devices for playing or editing audio files.

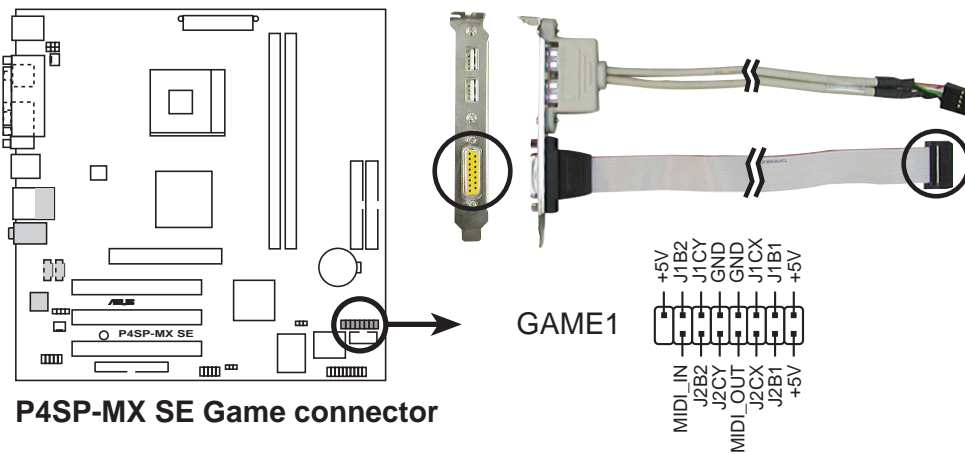

**P4SP-MX SE Game connector**



The GAME module is purchased separately.

## 9. Serial port connector (10-1 pin COM1)

This connector accommodates the bundled serial port module. Use the COM cable to connect the serial port module to this connector, then install the module into a slot opening at the front or back of the system chassis.

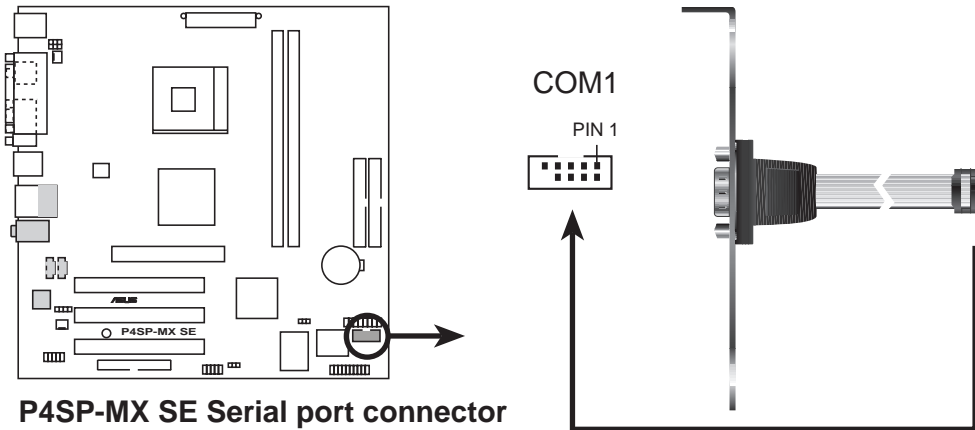

## 10. System panel connector (10-1 pin PANEL1)

This connector accommodates several system front panel functions.

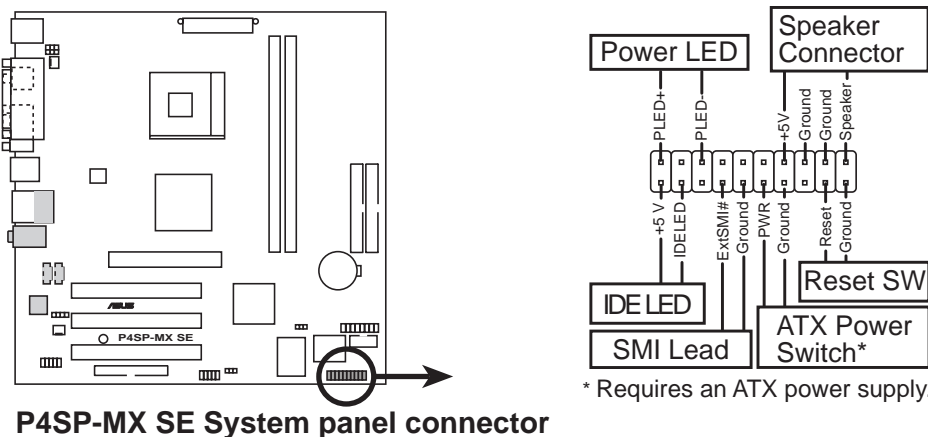

- **System Power LED Lead (3-1 pin PLED)**

This 3-1 pin connector connects to the system power LED. The LED lights up when you turn on the system power, and blinks when the system is in sleep mode.

- **System Warning Speaker Lead (4-pin SPEAKER)**

This 4-pin connector connects to the case-mounted speaker and allows you to hear system beeps and warnings.

- **System Management Interrupt Lead (2-pin SMI)**

This 2-pin connector allows you to manually place the system into a suspend mode, or “green” mode, where system activity is instantly decreased to save power and to expand the life of certain system components. Attach the case-mounted suspend switch to this 2-pin connector.

- **ATX Power Switch / Soft-Off Switch Lead (2-pin PWRBTN)**  
This connector connects a switch that controls the system power. Pressing the power switch turns the system between ON and SLEEP, or ON and SOFT OFF, depending on the BIOS or OS settings. Pressing the power switch while in the ON mode for more than 4 seconds turns the system OFF.
- **Reset Switch Lead (2-pin RESET)**  
This 2-pin connector connects to the case-mounted reset switch for rebooting the system without turning off the system power.
- **Hard Disk Activity Lead (2-pin IDELED)**  
This connector supplies power to the hard disk activity LED. The read or write activities of any device connected to the primary or secondary IDE connector cause this LED to light up.





# ***Chapter 2***

This chapter tells how to change system settings through the BIOS Setup menus. Detailed descriptions of the BIOS parameters are also provided.

## **BIOS information**

## 2.1 Managing and updating your BIOS

The following utilities allow you to manage and update the motherboard Basic Input/Output System (BIOS) setup.

1. **ASUS EZ Flash** (*Updates the BIOS using a floppy disk during POST.*)
2. **ASUS AFlash** (*Updates the BIOS using a floppy disk in DOS mode.*)
3. **ASUS CrashFree BIOS** (*Updates the BIOS using a bootable floppy disk.*)
4. **ASUS Update** (*Updates the BIOS in Windows® environment.*)

Refer to the corresponding section for details on these utilities.

### Important notes



- It is recommended that you save a copy of the **original motherboard BIOS file** to a **bootable floppy disk** in case you need to restore the BIOS in the future. Copy the original motherboard BIOS using the ASUS Update or AFLASH utilities.
- Visit the ASUS website and download the latest BIOS file for this motherboard using the ASUS Update utility.

### 2.1.1 Creating a bootable floppy disk

1. Do either one of the following to create a bootable floppy disk.

#### DOS environment

Insert a 1.44 MB floppy disk into the drive. At the DOS prompt, type:

```
format A:/S then press <Enter>.
```

#### Windows® 98SE/ME environment

- a. From your Windows desktop, click on **Start**, then select **My Computer**.
- b. Double-click on **Add/Remove Programs** icon from the Control Panel window.
- c. Click on the **Startup Disk** tab, then on **Create Disk...** button.
- d. Insert a 1.44 MB floppy disk when prompted. Follow the succeeding screen instructions to complete the process.

#### Windows® XP environment

- a. Insert a 1.44 MB floppy disk into the floppy disk drive.
  - b. From your Windows desktop, click on **Start**, then select **My Computer**.
  - c. Select the **3 1/2 Floppy Drive** icon.
  - d. Click **File** from the menu, then select **Format**. A **Format 3 1/2 Floppy Disk** window appears.
  - e. Select **Create an MS-DOS startup disk** from the format options field, then click **Start**.
2. Copy the original (or the latest) motherboard BIOS to the bootable floppy disk.

## 2.1.2 Using ASUS EZ Flash to update the BIOS

The ASUS EZ Flash feature allows you to easily update the BIOS without having to go through the long process of booting from a floppy disk and using a DOS-based utility. The EZ Flash is built-in the BIOS LPC chip so it is accessible by simply pressing <Alt> + <F2> during the Power-On Self Tests (POST).

### To update the BIOS using ASUS EZ Flash:

1. Visit the ASUS website ([www.asus.com](http://www.asus.com)) to download the latest BIOS file for your motherboard and rename it to **P4SPMXSE.BIN**. Save the BIOS file to a floppy disk.
2. Reboot the system.
3. To launch EZ Flash, press <Alt> + <F2> during POST to display the following.

```
User recovery requested. Starting BIOS recovery...
Checking for floppy...
```



- If there is no floppy disk found in the drive, the error message “**Floppy not found!**” appears.
- If the correct BIOS file is not found in the floppy disk, the error message “**P4SPMXSE.BIN not found!**”

4. Insert the floppy disk that contains the BIOS file. If the **P4SPMXSE.BIN** file is found in the floppy disk, EZ Flash performs the BIOS update process and automatically reboots the system when done.



DO NOT shutdown or reset the system while updating the BIOS! Doing so may cause system boot failure!

```
User recovery requested. Starting BIOS recovery...
Checking for floppy...
Floppy found!
Reading file "P4SPMXSE.BIN". Completed.
Start flashing...
Flashed successfully. Rebooting.
```

## 2.1.3 Using the AFLASH utility

AFLASH is a Flash Memory Writer utility that allows you to update the BIOS using a bootable floppy disk, or copy the original motherboard BIOS. This utility only works in DOS mode.

### Copying the original motherboard BIOS

To copy the original motherboard BIOS file:

1. Copy the AFLASH utility from the support CD to the boot disk you created.



AFLASH does not work in the DOS prompt within Windows®, and does not work with certain memory drivers that may be loaded when you boot from the hard drive. It is recommended that you reboot using a floppy disk.

2. Reboot the computer from the floppy disk.



The BIOS setup must specify “Floppy” as the first item in the boot sequence.

3. In DOS prompt, type AFLASH, then press <Enter> to run AFLASH.
4. Select **1. Save Current BIOS to File**, then press <Enter>. The **Save Current BIOS To File** screen appears.

```
ASUS ACPI BIOS
FLASH MEMORY WRITER V2.0
Copyright (C) 1994-2001 ASUSTeK COMPUTER INC.

Flash Memory: Winbond W29C020 or SST 29EE020 or Intel 02802AB

Current BIOS Version: ASUS XXX-XX ACPI BIOS Revision 100X
BIOS Model          : XXX-XX
BIOS Built Date     : 12/25/01

Choose one of the followings:
1. Save Current BIOS To File
2. Update BIOS Including Boot Block and ESCD

Enter choice: [1]

Press ESC To Exit
```



If the word “unknown” appears after Flash Memory, the memory chip is either not programmable or is not supported by the ACPI BIOS and therefore, cannot be programmed by the Flash Memory Writer utility.

5. Type a filename and the path, for example, A:\XXX-XX.XXX, then press <Enter>.

```
Save Current BIOS To File

Flash Memory: Winbond W29C020 or SST 29EE020 or Intel 02802AB

Current BIOS Version: ASUS XXX-XX ACPI BIOS Revision 100X
BIOS Model          : XXX-XX
BIOS Built Date     : 12/25/01

Please Enter File Name to Save: XXX-XX.XXX

BIOS Saved Successfully
Press ESC To Continue
```

## Updating the BIOS



Update the BIOS only if you have problems with the motherboard and you are sure that the new BIOS revision will solve your problems. Careless updating may result to more problems with the motherboard!

To update the BIOS:

1. Download an updated BIOS file from the ASUS website ([www.asus.com](http://www.asus.com)) and save the file to the bootable floppy disk you earlier .
2. Reboot the computer from the floppy disk.
3. In DOS prompt, type AFLASH, then press <Enter> to run AFLASH.

```
Update BIOS Including Boot Block and ESCD
Flash Memory: Winbond W29C020 or SST 29EE020 or Intel 82802AB
Current BIOS Version: ASUS XXX-XX ACPI BIOS Revision 100X
BIOS Model          : XXX-XX
BIOS Built Date     : 12/25/01
Please Enter File Name for NEW BIOS: A:\XXX-XX.XXX
```

4. Select **2. Update BIOS including Boot Block and ESCD**, then press <Enter>. The **Update BIOS Including Boot Block and ESCD** screen appears.
5. Type the filename of your new BIOS and the path, for example, **A:\P4SPMXSE.BIN**, then press <Enter>.

6. When prompted, press **Y** to start the update.

```
Update BIOS Including Boot Block and ESCD
Flash Memory: Winbond W29C020 or SST 29EE020 or Intel 82802AB
BIOS Version
[CURRENT ] ASUS XXX-XX ACPI BIOS Revision 100X
[test.awd] ASUS XXX-XX ACPI BIOS Revision 100X
BIOS Model
[CURRENT ] XXX-XX
[test.awd] XXX-XX
Date of BIOS Built
[CURRENT ] 09/25/99
[XXXX.XXX] 05/29/00
Check sum of 1001.010 is F266.
Are you sure (Y/N) ? [Y]
```

Press ESC To Return to Main Menu

7. The utility starts updating the BIOS. The boot block is automatically updated only when necessary. This minimizes the possibility of boot problems in case of update failures.

When updating is done, the message

*"Flashed Successfully"* appears.

```
Update BIOS Including Boot Block and ESCD
Flash Memory: Winbond W29C020 or SST 29EE020 or Intel 82802AB
BIOS Version
[CURRENT ] ASUS XXX-XX ACPI BIOS Revision 100X
[test.awd] ASUS XXX-XX ACPI BIOS Revision 100X
BIOS Model
[CURRENT ] XXX-XX
[test.awd] XXX-XX
Date of BIOS Built
[CURRENT ] 12/25/01
[XXXX.XXX] 05/29/00
Check sum of 1001.010 is F266.
Are you sure (Y/N) ? [Y]
Block Erasing -- Done
Programming -- 3FFFF
Flashed Successfully
Press ESC To Continue
```

8. Follow the screen instructions to continue.

```
ASUS ACPI BIOS
FLASH MEMORY WRITER V2.0
Copyright (C) 1994-2001 ASUSTeK COMPUTER INC.

Flash Memory: Winbond W29C020 or SST Z9EE020 or Intel 82802AB

Current BIOS Version: ASUS XXX-XX ACPI BIOS Revision 100X
BIOS Model          : XXX-XX
BIOS Built Date     : 12/25/01

Choose one of the followings:
1. Save Current BIOS To File
2. Update BIOS Including Boot Block and ESCD

Enter choice: [1]

You have flashed the EPROM; It is recommended that you turn off
the power, enter SETUP and Load Setup Defaults to have CMOS
updated with new BIOS when exits.

Press ESC To Exit
```



If you encounter problems while updating the new BIOS, DO NOT turn off the system because this may cause boot problems. Just repeat the process, and if the problem persists, load the original BIOS file you saved to the boot disk. If the Flash Memory Writer utility is not able to successfully update a complete BIOS file, the system may not boot. If this happens, call the ASUS Technical Support for assistance.

## 2.1.4 Recovering the BIOS with CrashFree BIOS

The CrashFree BIOS auto recovery tool allows you to restore BIOS from a floppy disk that contains the BIOS file, in case the current BIOS on the motherboard fails or gets corrupted.



- To use the CrashFree BIOS feature on this motherboard, install a VGA card in one of the expansion slots before rebooting the computer. On motherboards with onboard VGA, such as the **P4SP-MX SE**, you will not see the screen display when the BIOS crashes even if you reboot the computer.
- Prepare the **floppy disk that contains the motherboard BIOS** (P4SPMXSE.BIN) before proceeding with the BIOS update process.
- If you have saved a copy of the original motherboard BIOS to a bootable floppy disk, you may also use this disk to restore the BIOS. See section “2.1.1 Creating a bootable floppy disk.”

### To recover the BIOS from a floppy disk:

1. Boot the system.
2. When a corrupted BIOS is detected, the following message appears.

```
Bad BIOS checksum. Starting BIOS recovery...
Checking for floppy...
```

3. Insert a floppy disk that contains the original, or the latest, BIOS file for this motherboard (P4SPMXSE.BIN). If the BIOS file that you downloaded from the ASUS website has a different filename (e.g. P4SPMXSE\_1001.BIN), rename it to **P4SPMXSE.BIN**. The BIOS update process continues when the P4S800MXSE.BIN is found.

```
Bad BIOS checksum. Starting BIOS recovery...
Checking for floppy...
Floppy found!
Reading file "P4SPMXSE.BIN". Completed.
Start flashing...
```



DO NOT shutdown or reset the system while updating the BIOS! Doing so may cause system boot failure!

4. When the BIOS update process is complete, reboot the system.

## 2.1.5 ASUS Update

The ASUS Update is a utility that allows you to update the motherboard BIOS in Windows® environment. This utility is available in the support CD that comes with the motherboard package. ASUS Update requires an Internet connection either through a network or an Internet Service Provider (ISP).

To install ASUS Update:

1. Place the support CD to the optical drive. The **Drivers** menu appears.
2. Click the **Utilities** tab, then click **Install ASUS Update VX.XX.XX**. See page 3-3 for the **Utilities** menu screen.
3. The ASUS Update utility is copied into your system.

To update the BIOS using the ASUS Update:

1. Launch the utility from the Windows desktop by clicking **Start > Programs > ASUS > ASUSUpdate > ASUSUpdate**. The ASUS Update initial screen appears.
2. Select your desired update method, then click **Next**.

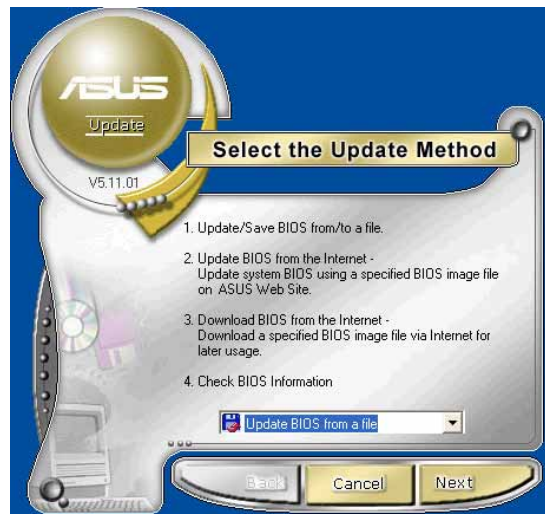



3. If you selected updating/downloading from the Internet, select the ASUS FTP site nearest you to avoid network traffic, or choose **Auto Select**. Click **Next**.

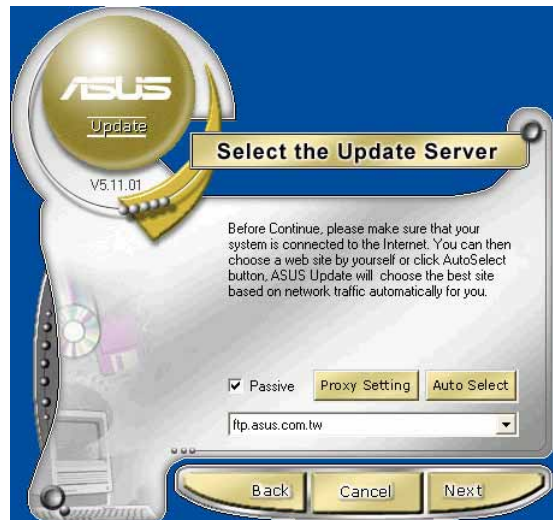

4. From the FTP site, select the BIOS version that you wish to download. Click **Next**.
5. Follow the instructions on the succeeding screens to complete the update process.

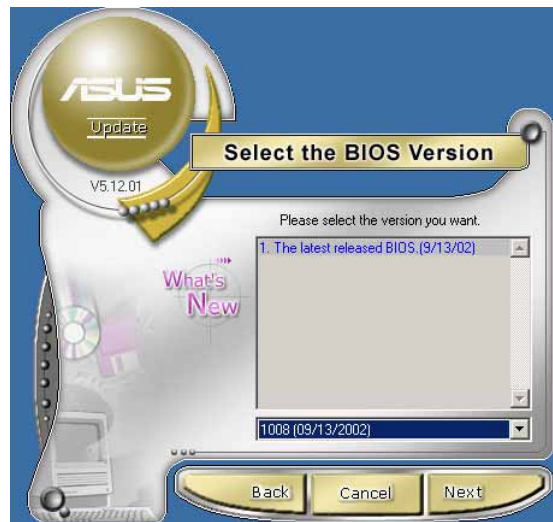

If you selected the option to update the BIOS from a file, a window pops up prompting you to locate the file. Select the file, click **Save**, then follow the screen instructions to complete the update process.

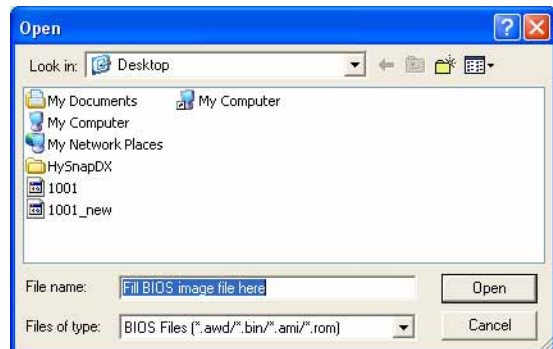



## 2.2 BIOS Setup program

This motherboard supports a programmable Flash ROM that you can update using the provided utility described in section “2.1 Managing and updating your BIOS.”

Use the BIOS Setup program when you are installing a motherboard, reconfiguring your system, or prompted to “Run Setup”. This section explains how to configure your system using this utility.

Even if you are not prompted to use the Setup program, you may want to change the configuration of your computer in the future. For example, you may want to enable the security password feature or make changes to the power management settings. This requires you to reconfigure your system using the BIOS Setup program so that the computer can recognize these changes and record them in the CMOS RAM of the Flash ROM.

The Flash ROM on the motherboard stores the Setup utility. When you start up the computer, the system provides you with the opportunity to run this program. Press <Delete> during the Power-On Self Test (POST) to enter the Setup utility, otherwise, POST continues with its test routines.

If you wish to enter Setup after POST, restart the system by pressing <Ctrl> + <Alt> + <Delete>, or by pressing the reset button on the system chassis. You can also restart by turning the system off and then back on. Do this last option only if the first two failed.

The Setup program is designed to make it as easy to use as possible. It is a menu-driven program, which means you can scroll through the various sub-menus and make your selections among the predetermined choices.



---

Because the BIOS software is constantly being updated, the following BIOS setup screens and descriptions are for reference purposes only, and may not exactly match what you see on your screen.

---

### 2.2.1 BIOS menu bar

The top of the screen has a menu bar with the following selections:

- |                 |  |
|-----------------|--|
| <b>MAIN</b>     | Use this menu to make changes to the basic system configuration.                                   |
| <b>ADVANCED</b> | Use this menu to enable and make changes to the advanced features.                                 |
| <b>POWER</b>    | Use this menu to configure and enable Power Management features.                                   |
| <b>BOOT</b>     | Use this menu to configure the default system device used to locate and load the Operating System. |
| <b>EXIT</b>     | Use this menu to exit the current menu or to exit the Setup program.                               |

To access the menu bar items, press the right or left arrow key on the keyboard until the desired item is highlighted.

## 2.2.2 Legend bar

At the bottom of the Setup screen is a legend bar. The keys in the legend bar allow you to navigate through the various setup menus. The following table lists the keys found in the legend bar with their corresponding functions.

<b>Navigation Key(s)</b>	<b>Function Description</b>
<b>&lt;F1&gt; or &lt;Alt + H&gt;</b>	Displays the General Help screen from anywhere in the BIOS Setup
<b>&lt;Esc&gt;</b>	Jumps to the Exit menu or returns to the main menu from a sub-menu
<b>Left or Right arrow</b>	Selects the menu item to the left or right
<b>Up or Down arrow</b>	Moves the highlight up or down between fields
<b>- (minus key)</b>	Scrolls backward through the values for the highlighted field
<b>+ (plus key) or spacebar</b>	Scrolls forward through the values for the highlighted field
<b>&lt;Enter&gt;</b>	Brings up a selection menu for the highlighted field
<b>&lt;Home&gt; or &lt;PgUp&gt;</b>	Moves the cursor to the first field
<b>&lt;End&gt; or &lt;PgDn&gt;</b>	Moves the cursor to the last field
<b>&lt;F5&gt;</b>	Resets the current screen to its Setup Defaults
<b>&lt;F10&gt;</b>	Saves changes and exits Setup

### General help

In addition to the Item Specific Help window, the BIOS setup program also provides a General Help screen. You may launch this screen from any menu by simply pressing <F1> or the <Alt> + <H> combination. The General Help screen lists the legend keys and their corresponding functions.

### Saving changes and exiting the Setup program

See "2.7 Exit Menu" for detailed information on saving changes and exiting the setup program.

### Scroll bar

When a scroll bar appears to the right of a help window, it indicates that there is more information to be displayed that will not fit in the window. Use <PgUp> and <PgDn> or the up and down arrow keys to scroll through the entire help document. Press <Home> to display the first page, press <End> to go to the last page. To exit the help window, press <Enter> or <Esc>.

## Sub-menu

Note that a right pointer symbol (as shown on the left) appears to the left of certain fields. This pointer indicates that you can display a sub-menu from this field. A sub-menu contains additional options for a field parameter. To display a sub-menu, move the highlight to the field and press <Enter>. The sub-menu appears. Use the legend keys to enter values and move from field to field within a sub-menu as you would within a menu. Use the <Esc> key to return to the main menu.

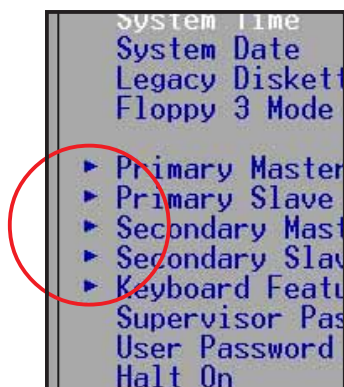

Take some time to familiarize yourself with the legend keys and their corresponding functions. Practice navigating through the various menus and sub-menus. If you accidentally make unwanted changes to any of the fields, use the set default hot key <F5> to load the Setup default values. While moving around through the Setup program, note that explanations appear in the Item Specific Help window located to the right of each menu. This window displays the help text for the currently highlighted field.

## 2.3 Main menu

When you enter the Setup program, the following screen appears.

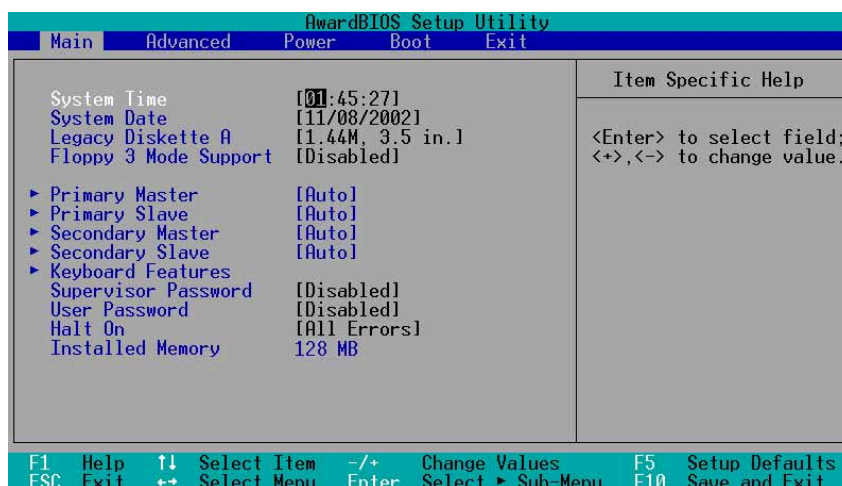

### System Time [XX:XX:XX]

Sets the system to the time that you specify (usually the current time). The format is hour, minute, second. Valid values for hour, minute and second are Hour: (00 to 23), Minute: (00 to 59), Second: (00 to 59). Use the <Tab> or <Shift> + <Tab> keys to move between the hour, minute, and second fields.

### System Date [XX/XX/XXXX]

Sets the system to the date that you specify (usually the current date). The format is month, day, year. Valid values for month, day, and year are Month: (1 to 12), Day: (1 to 31), Year: (up to 2099). Use the <Tab> or <Shift> + <Tab> keys to move between the month, day, and year fields.

## **Legacy Diskette A [1.44M, 3.5 in.]**

Sets the type of floppy drive installed. Configuration options: [None] [360K, 5.25 in.] [1.2M , 5.25 in.] [720K , 3.5 in.] [1.44M, 3.5 in.] [2.88M, 3.5 in.]

## **Floppy 3 Mode Support [Disabled]**

This is required to support older Japanese floppy drives. The Floppy 3 Mode feature allows reading and writing of 1.2MB (as opposed to 1.44MB) on a 3.5-inch diskette. Configuration options: [Disabled] [Enabled]

## **Supervisor Password [Disabled] / User Password [Disabled]**

These fields allow you to set passwords. To set a password, highlight the appropriate field and press <Enter>. Type in a password then press <Enter>. You can type up to eight alphanumeric characters. Symbols and other characters are ignored. To confirm the password, type the password again and press <Enter>. The password is now set to [Enabled]. This password allows full access to the BIOS Setup menus. To clear the password, highlight this field and press <Enter>. The same dialog box as above appears. Press <Enter>. The password is set to [Disabled].

### **A note about passwords**

The BIOS Setup program allows you to specify passwords in the Main menu. The passwords control access to the BIOS during system startup. Passwords are not case sensitive, meaning, passwords typed in either uppercase or lowercase letters are accepted. The BIOS Setup program allows you to specify two different passwords: a Supervisor password and a User password. If you did not set a Supervisor password, anyone can access the BIOS Setup program. If you did, the Supervisor password is required to enter the BIOS Setup program and to gain full access to the configuration fields.

### **Forgot the password?**

If you forget your password, you can clear it by erasing the CMOS Real Time Clock (RTC) RAM. The RAM data containing the password information is powered by the onboard button cell battery. If you need to erase the CMOS RAM, unplug the all the power cables and remove the button cell battery. Re-install the battery after about 2 seconds, then power up the system. Refer to section "1.9 Jumpers" on how to clear the RTC RAM.

## **Halt On [All Errors]**

This field specifies the types of errors that will cause the system to halt. Configuration options: [All Errors] [No Error] [All but Keyboard] [All but Disk] [All but Disk/Keyboard]

## **Installed Memory [XXX MB]**

This field automatically displays the amount of conventional memory detected by the system during the boot process.

## 2.3.1 Primary and Secondary Master/Slave

AwardBIOS Setup Utility			
Main			
Primary Master [Auto]		Item Specific Help	
Type	[Auto]	<p>&lt;Enter&gt; to select the type of the IDE drive. [User Type HDD] allows you to set each entry on your own.</p> <p>WARNING: Ultra DMA mode 3/4/5 can be enabled only when BIOS detects shielded 80-pin cable.</p>	
Cylinders	[ 1024]		
Head	[255]		
Sector	[63]		
CHS Capacity	8422MB		
Maximum LBA Capacity	25590MB		
Multi-Sector Transfers	[Maximum]		
SMART Monitoring	[Disabled]		
PIO Mode	[4]		
ULTRA DMA Mode	[Disabled]		
F1 Help	↑↓ Select Item	-/+ Change Values	F5 Setup Defaults
ESC Exit	↔ Select Menu	Enter Select ▶ Sub-Menu	F10 Save and Exit

### Type [Auto]

Select [Auto] to automatically detect an IDE hard disk drive. If automatic detection is successful, Setup automatically fills in the correct values for the remaining fields on this sub-menu. If automatic detection fails, this may be because the hard disk drive is too old or too new. If the hard disk was formatted on an older system, Setup may detect incorrect parameters. In these cases, select [User Type HDD] to manually enter the IDE hard disk drive parameters. Refer to the next section for details.



Before attempting to configure a hard disk drive, make sure you have the correct configuration information supplied by the drive manufacturer. Incorrect settings may cause the system to fail to recognize the installed hard disk.

### [User Type HDD]

AwardBIOS Setup Utility			
Main			
Primary Master [User Type HDD]		Item Specific Help	
Type	[User Type HDD]	<p>&lt;Enter&gt; to select the type of the IDE drive. [User Type HDD] allows you to set each entry on your own.</p> <p>WARNING: Ultra DMA mode 3/4/5 can be enabled only when BIOS detects shielded 80-pin cable.</p>	
Translation Method	[LBA]		
Cylinders	[ 1024]		
Head	[255]		
Sector	[63]		
CHS Capacity	8422MB		
Maximum LBA Capacity	25590MB		
Multi-Sector Transfers	[Maximum]		
SMART Monitoring	[Disabled]		
PIO Mode	[4]		
ULTRA DMA Mode	[Disabled]		
F1 Help	↑↓ Select Item	-/+ Change Values	F5 Setup Defaults
ESC Exit	↔ Select Menu	Enter Select ▶ Sub-Menu	F10 Save and Exit

Manually enter the number of cylinders, heads and sectors per track for the drive. Refer to the drive documentation or on the drive label for this information.





---

After entering the IDE hard disk drive information into BIOS, use a disk utility, such as FDISK, to partition and format new IDE hard disk drives. This is necessary so that you can write or read data from the hard disk. Make sure to set the partition of the Primary IDE hard disk drives to active.

---

If no drive is installed or if you are removing a drive and not replacing it, select [None].

Other options for the Type field are:

**[CD-ROM]** - for IDE CD-ROM drives

**[LS-120]** - for LS-120 compatible floppy disk drives

**[ZIP]** - for ZIP-compatible disk drives

**[MO]** - for IDE magneto optical disk drives

**[Other ATAPI Device]** - for IDE devices not listed here

After making your selections on this sub-menu, press the <Esc> key to return to the Main menu. When the Main menu appears, the hard disk drive field displays the size for the hard disk drive that you configured.

### **Translation Method [LBA]**

Select the hard disk drive type in this field. When Logical Block Addressing (LBA) is enabled, the 28-bit addressing of the hard drive is used without regard for cylinders, heads, or sectors. Note that LBA Mode is necessary for drives with more than 504MB storage capacity. Configuration options: [LBA] [LARGE] [Normal] [Match Partition Table] [Manual]

### **Cylinders**

This field configures the number of cylinders. Refer to the drive documentation to determine the correct value. To make changes to this field, set the Type field to [User Type HDD] and the Translation Method field to [Manual].

### **Head**

This field configures the number of read/write heads. Refer to the drive documentation to determine the correct value. To make changes to this field, set the Type field to [User Type HDD] and the Translation Method field to [Manual].

### **Sector**

This field configures the number of sectors per track. Refer to the drive documentation to determine the correct value. To make changes to this field, set the Type field to [User Type HDD] and the Translation Method field to [Manual].

### **CHS Capacity**

This field shows the drive's maximum CHS capacity as calculated by the BIOS based on the drive information you entered.

### **Maximum LBA Capacity**

This field shows the drive's maximum LBA capacity as calculated by the BIOS based on the drive information you entered.

## Multi-Sector Transfers [Maximum]

This option automatically sets the number of sectors per block to the highest number that the drive supports. Note that when this field is automatically configured, the set value may not always be the fastest value for the drive. You may also manually configure this field. Refer to the documentation that came with the hard drive to determine the optimum value and set it manually. To make changes to this field, set the Type field to [User Type HDD]. Configuration options: [Disabled] [2 Sectors] [4 Sectors] [8 Sectors] [16 Sectors] [32 Sectors] [Maximum]

## SMART Monitoring [Disabled]

This field allows you to enable or disable the S.M.A.R.T. (Self-Monitoring, Analysis and Reporting Technology) system that utilizes internal hard disk drive monitoring technology. This parameter is normally disabled because the resources used in the SMART monitoring feature may decrease system performance.

Configuration options: [Disabled] [Enabled]

## PIO Mode [4]

This option lets you set a PIO (Programmed Input/Output) mode for the IDE device. Modes 0 through 4 provide successive increase in performance.

Configuration options: [0] [1] [2] [3] [4]

## Ultra DMA Mode [Disabled]

Ultra DMA capability allows improved transfer speeds and data integrity for compatible IDE devices. Set to [Disabled] to suppress Ultra DMA capability. To make changes to this field, set the Type field to [User Type HDD].

Configuration options: [0] [1] [2] [3] [4] [5] [6] [Disabled]

## 2.3.2 Keyboard Features

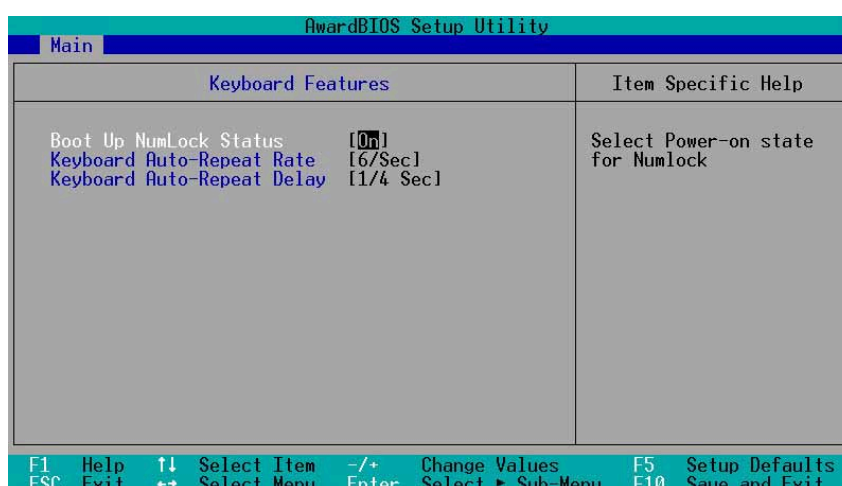

### Boot Up NumLock Status [On]

This field enables users to activate the Number Lock function upon system boot.

Configuration options: [Off] [On]

## Keyboard Auto-Repeat Rate [12/Sec]

This controls the speed at which the system registers repeated keystrokes. Options range from 6 to 30 characters per second. Configuration options: [6/Sec] [8/Sec] [10/Sec] [12/Sec] [15/Sec] [20/Sec] [24/Sec] [30/Sec]

## Keyboard Auto-Repeat Delay [1/4 Sec]

This field sets the time interval for displaying the first and second characters. Configuration options: [1/4 Sec] [1/2 Sec] [3/4 Sec] [1 Sec]

## 2.4 Advanced menu

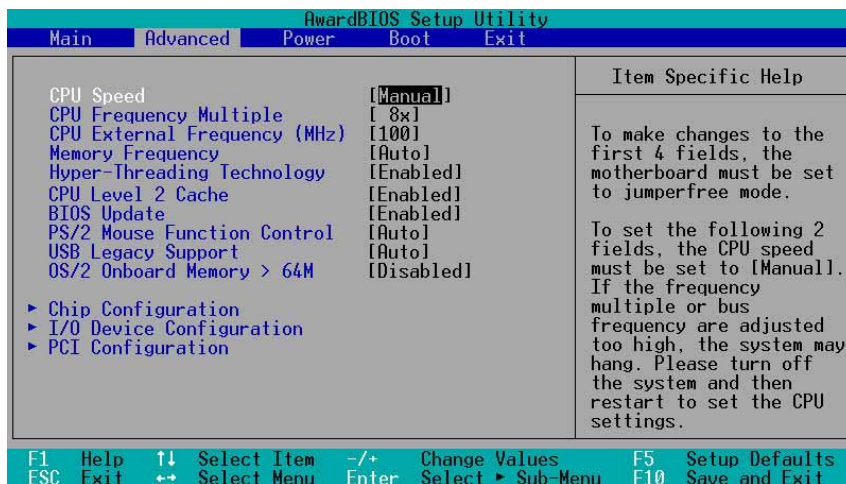

### CPU Speed [Manual]

When the motherboard is set to JumperFree™ mode, this field allows you to select the internal frequency of the CPU. Select [Manual] if you want to make changes to the two subsequent fields. Note that selecting a frequency higher than the CPU manufacturer recommends may cause the system to hang or crash.

### CPU Frequency Multiple [Xx]

This field sets the frequency multiple between the CPU's internal frequency (CPU speed) and external frequency. Set this field in conjunction with CPU Frequency (MHz) to match the speed of the CPU. This item is configurable only when you set the CPU Speed option to [Manual].



The item **CPU Frequency Multiple** is accessible only if you have an unlocked processor. If your processor frequency multiple is locked, you cannot change the setting of this item.

### CPU External Frequency (XXX/XX)

This item is configurable only when you set the CPU Speed item to [Manual]. This feature tells the clock generator what frequency to send to the system bus and PCI bus. The bus frequency (external frequency) multiplied by the bus multiple equals the CPU speed.



### **Memory Frequency [Auto]**

This field determines whether the memory clock frequency is set to be in synchronous or asynchronous mode with respect to the system frequency. The options that appear in the popup menu vary according to the CPU Frequency (MHz). Configuration options: [Auto] [266MHz] [333MHz] [400MHz]

### **CPU Level 2 Cache [Enabled]**

This field allows you to choose from the default [Enabled] or choose [Disabled] to turn on or off the CPU Level 2 built-in cache.

Configuration options: [Disabled] [Enabled]

### **BIOS Update [Enabled]**

This field functions as an update loader integrated into the BIOS to supply the processor with the required data. When set to [Enabled], the BIOS loads the update on all processors during system bootup.

Configuration options: [Disabled] [Enabled]

### **PS/2 Mouse Function Control [Auto]**

The default setting [Auto] allows the system to detect a PS/2 mouse at startup. If a mouse is detected, the BIOS assigns IRQ12 to the PS/2 mouse. Otherwise, IRQ12 can be used for expansion cards. When you set this field to [Enabled], BIOS reserves IRQ12, whether or not a PS/2 mouse is detected at startup.

Configuration options: [Enabled] [Auto]

### **USB Legacy Support [Auto]**

This motherboard supports Universal Serial Bus (USB) devices. The default of [Auto] allows the system to detect a USB device at startup. If detected, the USB controller legacy mode is enabled. If not detected, the USB controller legacy mode is disabled.

When you set this field to [Disabled], the USB controller legacy mode is disabled whether or not you are using a USB device. Configuration options: [Disabled] [Enabled] [Auto]

### **OS/2 Onboard Memory > 64M [Disabled]**

When using OS/2 operating systems with installed DRAM of greater than 64MB, you need to set this option to [Enabled]. Otherwise, leave to the default setting [Disabled]. Configuration options: [Disabled] [Enabled]

## 2.4.1 Chip Configuration

AwardBIOS Setup Utility		
Advanced		
Chip Configuration		Item Specific Help
SDRAM Configuration	[By SPD]	<Enter> to select SDRAM configuration. [By SPD] is recommended. [User Define] allows you to set each configuration on your own.
SDRAM CAS Latency	[2T]	
SDRAM RAS to CAS Delay	[4T]	
SDRAM RAS Precharge Time	[4T]	
SDRAM RAS Active Time	[7T]	
SDRAM Command Lead-off Time	[Auto]	
Graphics Aperture Size	[64MB]	
AGP Fast Write Capability	[Enabled]	
Onboard VGA Shared Memory Size	[32M]	
Video Memory Cache Mode	[UC]	
PCI 2.1 Support	[Enabled]	
Onboard PCI IDE Enable	[Both]	
IDE Bus Master Support	[Enabled]	

F1 Help ↑↓ Select Item -/+ Change Values F5 Setup Defaults  
ESC Exit ↔ Select Menu Enter Select ► Sub-Menu F10 Save and Exit

### SDRAM Configuration [By SPD]

This parameter allows you to set the optimal timings for items 2–5, depending on the memory modules you are using. The default setting is [By SPD], which configures items 2 ~ 5 by reading the contents in the SPD (Serial Presence Detect) device. The EEPROM on the memory module stores critical information about the module, such as memory type, size, speed, voltage interface, and module banks. Configuration options: [User Defined] [By SPD]



The SDRAM parameters (items 2 ~ 5) are user-configurable only when you set the SDRAM Configuration to [User Defined].

### SDRAM CAS Latency (XT)

This item controls the latency between the SDRAM read command and the actual time the data becomes available. Configuration options: [2.5T] [2T] [1.5T] [3T]

### SDRAM RAS to CAS Delay (XT)

This item controls the latency between the DDR SDRAM active command and the read/write command. Configuration options: [3T] [2T] [4T]

### SDRAM RAS Precharge Time (XT)

This item controls the idle clocks after issuing a precharge command to the DDR SDRAM. Configuration options: [3T] [2T] [4T]

### SDRAM Active Time (XT)

This item controls the number of DDR SDRAM clocks used for DDR SDRAM parameters. Configuration options: [6T] [7T] [5T] [4T]

### SDRAM Command Lead-off Time [Auto]

Configuration options: [Auto] [2T] [1T]

### **Graphics Aperture Size [64MB]**

This feature allows you to select the size of mapped memory for AGP graphic data.  
Configuration options: [4MB] [8MB] [16MB] [32MB] [64MB] [128MB] [256MB]

### **AGP Fast Write Capability [Enabled]**

This field enables or disables the AGP 4x Fast Write Capability feature.  
Configuration options: [Disabled] [Enabled]

### **Onboard VGA Shared Memory Size [32M]**

This field allows you to set the onboard VGA memory size with the currently installed memory. Configuration options: [32M] [64M]

### **Video Memory Cache Mode [UC]**

USWC (uncacheable, speculative write combining) is a new cache technology for processor video memory. This feature improves the display speed by caching the display data. You must set this item to UC (uncacheable) if your graphics card does not support this feature, otherwise the system may not boot.

Configuration options: [UC] [USWC]

### **PCI 2.1 Support [Enabled]**

This field enables or disables the motherboard feature to support PCI 2.1 cards.  
Configuration options: [Disabled] [Enabled]

### **Onboard PCI IDE [Both]**

This field allows you to enable either the primary IDE channel or secondary IDE channel, or both. You may also set both channels to [Disabled].

Configuration options: [Both] [Primary] [Secondary] [Disabled]

### **IDE Bus Master Support [Enabled]**

This item controls the IDE Bus Master support for non-Windows® operating systems. Configuration options: [Disabled] [Enabled]

## 2.4.2 I/O Device Configuration

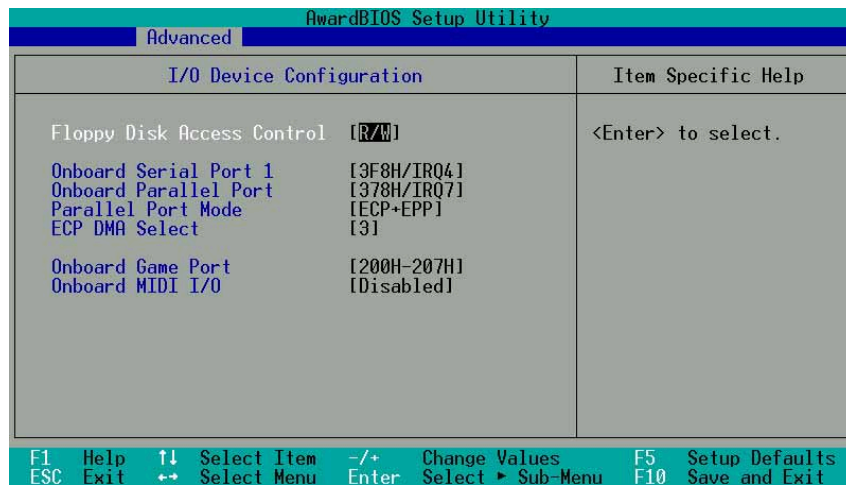

### Floppy Disk Access Control [R/W]

Setting this item to [Read Only] allows the floppy disk drive to only read data from a floppy disk. The default setting [R/W] allows both reading and writing data to a floppy disk. Configuration options: [R/W] [Read Only]

### Onboard Serial Port 1 [3F8H/IRQ4]

This field allows you to set the addresses for the onboard serial connector. Configuration options: [3F8H/IRQ4] [2F8H/IRQ3] [3E8H/IRQ4] [2E8H/IRQ10] [Disabled]

### Onboard Parallel Port [378H/IRQ7]

This field allows you to set the address of the onboard parallel port connector. If you disable this field, the **Parallel Port Mode** and **ECP DMA Select** options do not appear. Configuration options: [Disabled] [378H/IRQ7] [278H/IRQ5]

### Parallel Port Mode [ECP+EPP]

This field allows you to set the operation mode of the parallel port. [Normal] allows normal-speed operation but in one direction only; [EPP] allows bi-directional parallel port operation; [ECP] allows the parallel port to operate in bi-directional DMA mode; [ECP+EPP] allows normal speed operation in a two-way mode. Configuration options: [Normal] [EPP] [ECP] [ECP+EPP]

### ECP DMA Select [3]

This field allows you to configure the parallel port DMA channel for the selected ECP mode. This selection is available only if you select [ECP] or [ECP+EPP] in Parallel Port Mode above. Configuration options: [1] [3]

### Onboard Game Port [200H-207H]

This field sets the I/O address for the game port. Configuration options: [Disabled] [200H-207H] [208H-20FH]

### Onboard MIDI I/O [Disabled]

This field sets the I/O address for the MIDI I/O port. Configuration options: [Disabled] [330H-331H] [300H-301H]

## 2.4.3 PCI Configuration

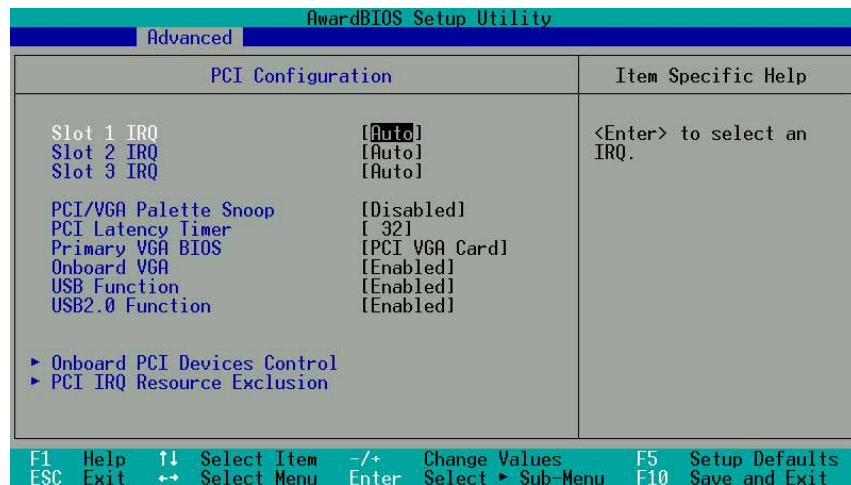

### Slot 1, Slot 2, Slot 3 IRQ [Auto]

These fields automatically assign the IRQ for each PCI slot. The default setting for each field is [Auto], which utilizes auto-routing to determine IRQ assignments.

Configuration options: [Auto] [NA] [3] [4] [5] [7] [9] [10] [11] [12] [14] [15]

### PCI/VGA Palette Snoop [Disabled]

Some non-standard VGA cards, like graphics accelerators or MPEG video cards, may not show colors properly. Setting this field to [Enabled] corrects this problem. If you are using standard VGA cards, leave this field to the default setting [Disabled]. Configuration options: [Disabled] [Enabled]

### PCI Latency Timer [32]

Leave this field to the default setting [32] for best performance and stability.

### Primary VGA BIOS [PCI VGA Card]

This field allows you to select the primary graphics card.

Configuration options: [PCI VGA Card] [AGP VGA Card] [Onboard VGA]

### Onboard VGA [Enabled]

This field allows you to enable or disable the onboard VGA port.

Configuration options: [Disabled] [Enabled]

### USB Function [Enabled]

This field allows you to enable or disable the USB function.

Configuration options: [Disabled] [Enabled]

### USB Function 2.0 [Enabled]

This field allows you to enable or disable the USB 2.0 function.

Configuration options: [Disabled] [Enabled]

## Onboard PCI Devices Control

AwardBIOS Setup Utility	
Advanced	
Onboard PCI Devices Control	Item Specific Help
Onboard LAN [Enabled] Onboard LAN Boot ROM [Disabled] Onboard AC97 Audio Controller [Auto]	<Enter> to enable or disable.
F1 Help ↑↓ Select Item -/+ Change Values F5 Setup Defaults ESC Exit ↔ Select Menu Enter Select ▶ Sub-Menu F10 Save and Exit	

### **Onboard LAN [Enabled]**

This field allows you enable or disable the onboard LAN.

Configuration options: [Disabled] [Enabled]

### **Onboard LAN Boot ROM [Disabled]**

This field allows you enable or disable the onboard LAN Boot ROM feature.

Configuration options: [Disabled] [Enabled]

### **Onboard AC97 Audio Controller [Auto]**

This field allows you to disable the onboard AC97 audio controller or set to the default [Auto] for optimum performance. Configuration options: [Disabled] [Auto]

## PCI IRQ Resource Exclusion

AwardBIOS Setup Utility	
Advanced	
PCI IRQ Resource Exclusion	Item Specific Help
IRQ 3 Reserved [No/ICU] IRQ 4 Reserved [No/ICU] IRQ 5 Reserved [No/ICU] IRQ 7 Reserved [No/ICU] IRQ 9 Reserved [No/ICU] IRQ 10 Reserved [No/ICU] IRQ 11 Reserved [No/ICU] IRQ 12 Reserved [No/ICU] IRQ 14 Reserved [No/ICU] IRQ 15 Reserved [No/ICU]	Select [Yes] if this IRQ is required by a legacy ISA card and you are not using ICU; otherwise, select [No/ICU].
F1 Help ↑↓ Select Item -/+ Change Values F5 Setup Defaults ESC Exit ↔ Select Menu Enter Select ▶ Sub-Menu F10 Save and Exit	



## IRQ XX Reserved [No/ICU]

These fields indicate whether or not the displayed IRQ for each field is being used by a legacy (non-PnP) ISA card. The setting [No/ICU] for an IRQ field indicates that you are using the ISA Configuration Utility (ICU), and that this particular IRQ is NOT required by a legacy ISA card. Set the IRQ field to [Yes] if you install a legacy ISA card that requires a unique IRQ and you are NOT using ICU.

Configuration options: [No/ICU] [Yes]

## 2.5 Power menu

The Power menu allows you to reduce power consumption. This feature turns off the video display and shuts down the hard disk after a period of inactivity.

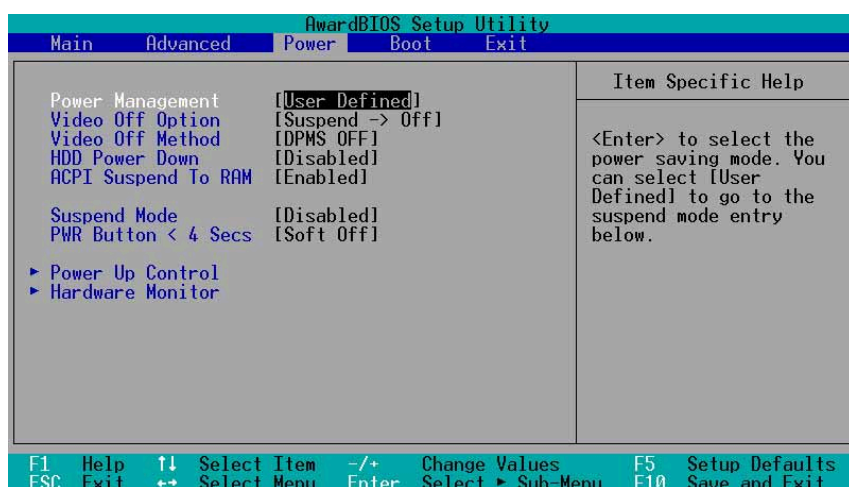

### Power Management [User Defined]

This field allows you to activate or deactivate the automatic power saving features of this motherboard. When set to [Disabled], power management does not function regardless of the other settings on this menu. The [User Defined] option allows you to set the period of inactivity before the system enters suspend mode. Refer to the "Suspend Mode" item for details.

When set to [Max Saving], system power is conserved to its greatest amount. This setting automatically puts the system into suspend mode after a brief period of inactivity. [Min Saving] allows the system to enter suspend mode after a long period of inactivity. Configuration options: [User Defined] [Disabled] [Min Saving] [Max Saving]

### Video Off Option [Suspend -> Off]

This field determines when to activate the video off feature for monitor power management. Configuration options: [Suspend -> Off] [Always On]

### Video Off Method [DPMS OFF]

This field defines the video off features. The Display Power Management System (DPMS) allows the BIOS to control the video display card if it supports DPMS. Set this option to [Blank Screen] when using monitors that do not support power management or "green" features.



Your screen saver does not display when you select [Blank Screen] as your video-off method.

[V/H SYNC+Blank] blanks the screen and turns off vertical and horizontal scanning. Configuration options: [Blank Screen] [V/H SYNC+Blank] [DPMS Standby] [DPMS Suspend] [DPMS OFF] [DPMS Reduce ON]

### HDD Power Down [Disabled]

Shuts down any IDE hard disk drives in the system after a period of inactivity as set in this user-configurable field. This feature does not affect SCSI hard drives. Configuration options: [Disabled] [1 Min] [2 Min] [3 Min]...[15 Min]

### ACPI Suspend To RAM [Disabled]

This field allows you to enable or disable the ACPI Suspend-to-RAM feature. To support this feature, the +5VSB of the power supply should have the capacity to provide more than 720mA current. Configuration options: [Disabled] [Enabled]

### Suspend Mode [Disabled]

Sets the time period before the system goes into suspend mode. Configuration options: [Disabled] [1~2 Min] [2~3 Min] [4~5 min] [8~9 Min] [20 Min] [30 Min]

### PWR Button < 4 Secs [Soft Off]

When set to [Soft off], the ATX switch can be used as a normal system power-off button when pressed for less than 4 seconds. [Suspend] allows the button to have a dual function where pressing less than 4 seconds puts the system in sleep mode. Regardless of the setting, holding the ATX switch for more than 4 seconds powers off the system. Configuration options: [Soft off] [Suspend]

## 2.5.1 Power Up Control

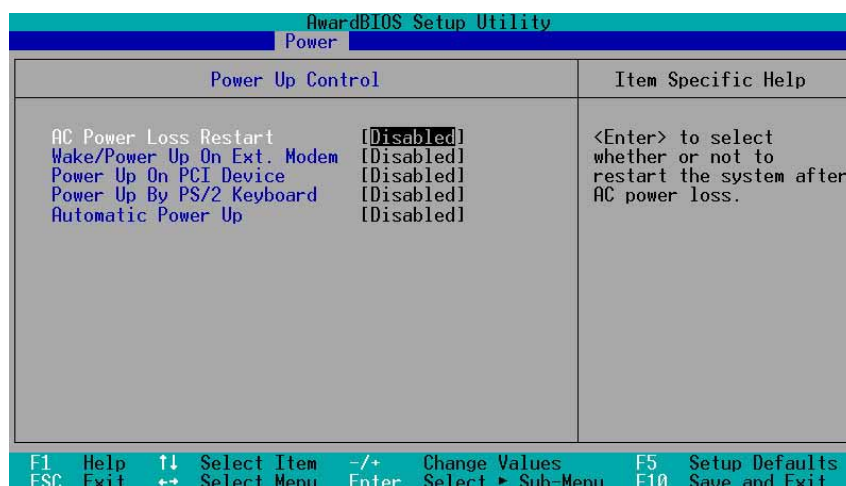

### AC PWR Loss Restart [Disabled]

This allows you to set whether or not to reboot the system after power interruptions. [Disabled] leaves your system off while [Enabled] reboots the system. [Previous State] sets the system back to the state it was before the power interruption. Configuration options: [Disabled] [Enabled] [Previous State]



## Wake/Power Up On Ext. Modem [Disabled]

This allows either settings of [Enabled] or [Disabled] for powering up the computer when the external modem receives a call while the computer is in Soft-off mode.

Configuration options: [Disabled] [Enabled]



The computer cannot receive or transmit data until the computer and applications are fully running. Thus, connection cannot be made on the first try. Turning an external modem off and then back on while the computer is off causes an initialization string that turns the system power on.

## Power Up On PCI Device [Disabled]

When set to [Enabled], this parameter allows you to turn on the system through a PCI LAN or modem card. This feature requires an ATX power supply that provides at least 1A on the +5VSB lead. Configuration options: [Disabled] [Enabled]

## Power On By PS/2 Keyboard [Disabled]

This parameter allows you to use specific keys on the keyboard to turn on the system. This feature requires an ATX power supply that provides at least 1A on the +5VSB lead. Configuration options: [Disabled] [Space Bar] [Ctrl-Esc] [Power Key]

## Automatic Power Up [Disabled]

This allows an unattended or automatic system power up. You may configure your system to power up at a certain time of the day by selecting [Everyday] or at a certain time and day by selecting [By Date]. Configuration options: [Disabled] [Everyday] [By Date]

## 2.5.2 Hardware Monitor

AwardBIOS Setup Utility		
Power		
Hardware Monitor		Item Specific Help
CPU Temperature	49.5°C/121°F	<Enter> to select.
CPU Fan Speed	9820RPM	
Chassis Fan Speed	9820RPM	
VCORE Voltage	1.50V	
+3.3V Voltage	3.47V	
+5V Voltage	4.89V	
+12V Voltage	11.90V	
F1 Help ↑↓ Select Item -/+ Change Values F5 Setup Defaults		
ESC Exit ↔ Select Menu Enter Select ► Sub-Menu F10 Save and Exit		

### CPU Temperature [XX°C/XX°F]

The onboard hardware monitor automatically detects and displays the CPU temperature in degree Celsius. Select [Ignore] to disable the CPU temperature auto-detect function.

## CPU Fan Speed [xxxxRPM] or [N/A]

## Chassis Fan Speed [xxxxRPM] or [N/A]

The onboard hardware monitor automatically detects and displays the CPU, chassis, and power fan speeds in rotations per minute (RPM). If any of the fans is not connected to the motherboard, the specific field shows N/A.

## VCORE Voltage, +3.3V Voltage, +5V Voltage, +12V Voltage

The onboard hardware monitor automatically detects the voltage output through the onboard voltage regulators.



If any of the monitored items is out of range, the following error message appears: "Hardware Monitor found an error. Enter Power setup menu for details". You will then be prompted to "Press F1 to continue or DEL to enter SETUP".

## 2.6 Boot menu

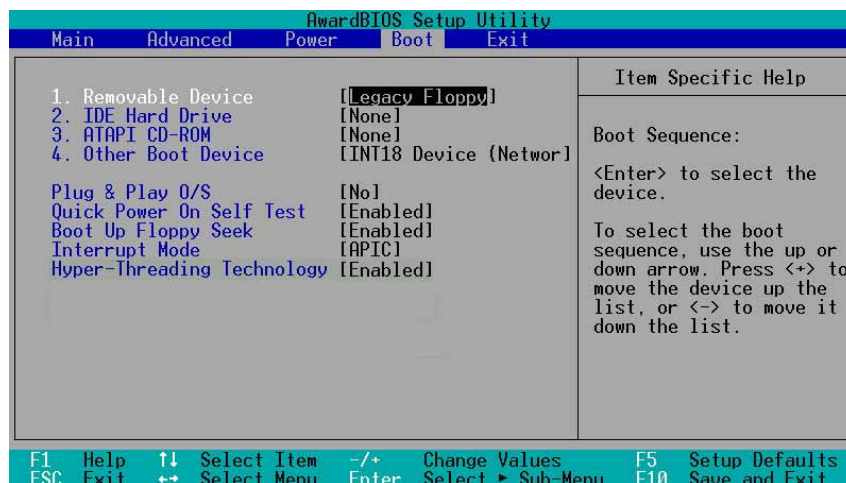

### Boot Sequence

The Boot menu allows you to select among the four possible types of boot devices listed using the up and down arrow keys. By using the <+> or <Space> key, you can promote devices and by using the <-> key, you can demote devices. Promotion or demotion of devices alters the priority which the system uses to search for a boot device on system power up. Configuration fields include Removable Devices, IDE Hard Drive, ATAPI CD-ROM, and Other Boot Device.

### Removable Device [Legacy Floppy]

Configuration options: [Disabled] [Legacy Floppy] [LS-120] [ZIP] [ATAPIMO] [USB FDD] [USB ZIP]

### IDE Hard Drive

This field allows you to select which IDE hard disk drive to use in the boot sequence. Pressing [Enter] will show the product IDs of all connected IDE hard disk drives.

## **ATAPI CD-ROM**

This field allows you to select which ATAPI CD-ROM drive to use in the boot sequence. Pressing [Enter] will show the product IDs of all your connected ATAPI CD-ROM drives.

## **Other Boot Device Select [INT18 Device (Network)]**

Configuration options: [Disabled] [SCSI Boot Device] [INT18 Device (Network)]

## **Plug & Play O/S [No]**

This field allows you to use a Plug-and-Play (PnP) operating system to configure the PCI bus slots instead of using the BIOS. When [Yes] is selected, interrupts may be reassigned by the OS. If you installed a non-PnP OS or if you want to prevent reassigning of interrupt settings, keep the default setting [No]. Configuration options: [No] [Yes]

## **Quick Power On Self Test [Enabled]**

This field speeds up the Power-On-Self Test (POST) routine by skipping retesting a second, third, and fourth time. Configuration options: [Enabled] [Disabled]

## **Boot Up Floppy Seek [Enabled]**

When enabled, the BIOS will seek the floppy disk drive to determine whether the drive has 40 or 80 tracks. Configuration options: [Enabled] [Disabled]

## **Interrupt Mode [APIC]**

The Advanced Programmable Interrupt Controller (APIC) setting allows you to distribute interrupt routings other than the 16 IRQs. The Programmable Interrupt Controller (PIC) setting allows you to use the 16 IRQs only.

Configuration options: [APIC] [PIC]

## 2.7 Exit menu

After configuring the BIOS save your changes and exit Setup. Select Exit from the menu bar to display the following menu.

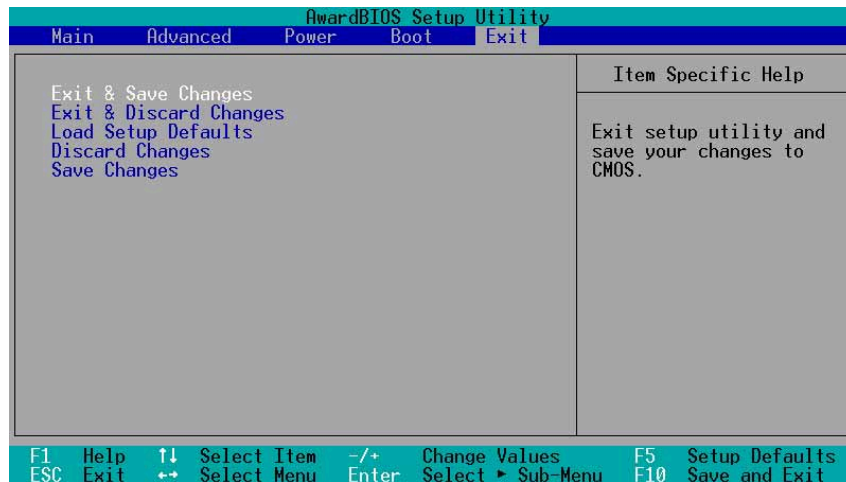

Pressing <Esc> does not immediately exit this menu. Select one of the options from this menu or <F10> from the legend bar to exit.

### Exit & Save Changes

Once you are finished making your selections, choose this option from the Exit menu to ensure the values you selected are saved to the CMOS RAM. The CMOS RAM is sustained by an onboard backup battery and stays on even when the PC is turned off. When you select this option, a confirmation window appears. Select [Yes] to save changes and exit.



If you attempt to exit the Setup program without saving your changes, the program prompts you with a message asking if you want to save your changes before exiting. Pressing <Enter> saves the changes while exiting.

### Exit & Discard Changes

Select this option only if you do not want to save the changes that you made to the Setup program. If you made changes to fields other than system date, system time, and password, the BIOS asks for a confirmation before exiting.

### Load Setup Defaults

This option allows you to load the default values for each of the parameters on the Setup menus. When you select this option or if you press <F5>, a confirmation window appears. Select [Yes] to load default values. Select Exit & Save Changes or make other changes before saving the values to the non-volatile RAM.

### Discard Changes

This option allows you to discard the selections you made and restore the previously saved values. After selecting this option, a confirmation appears. Select [Yes] to discard any changes and load the previously saved values.

### Save Changes

This option saves your selections without exiting the Setup program. You can then return to other menus and make further changes. After you select this option, a confirmation window appears. Select [Yes] to save changes to the non-volatile RAM.

# ***Chapter 3***

This chapter describes the contents of the support CD that comes with the motherboard package.

## **Software support**

## 3.1 Install an operating system

This motherboard supports Windows® 98SE/ME/2000/XP operating system (OS). Always install the latest OS version and corresponding updates so you can maximize the features of your hardware.



---

Because motherboard settings and hardware options vary, use the setup procedures presented in this chapter for general reference only. Refer to your OS documentation for more information.

---

## 3.2 Support CD information

The support CD that came with the motherboard contains useful software and several utility drivers that enhance the motherboard features.



---

The contents of the support CD are subject to change at any time without notice. Visit the ASUS website for updates.

---

### 3.2.1 Running the support CD

Place the support CD to your optical drive. The CD automatically displays the **Installation Items** window if Autorun is enabled in your computer. Click an item to install.

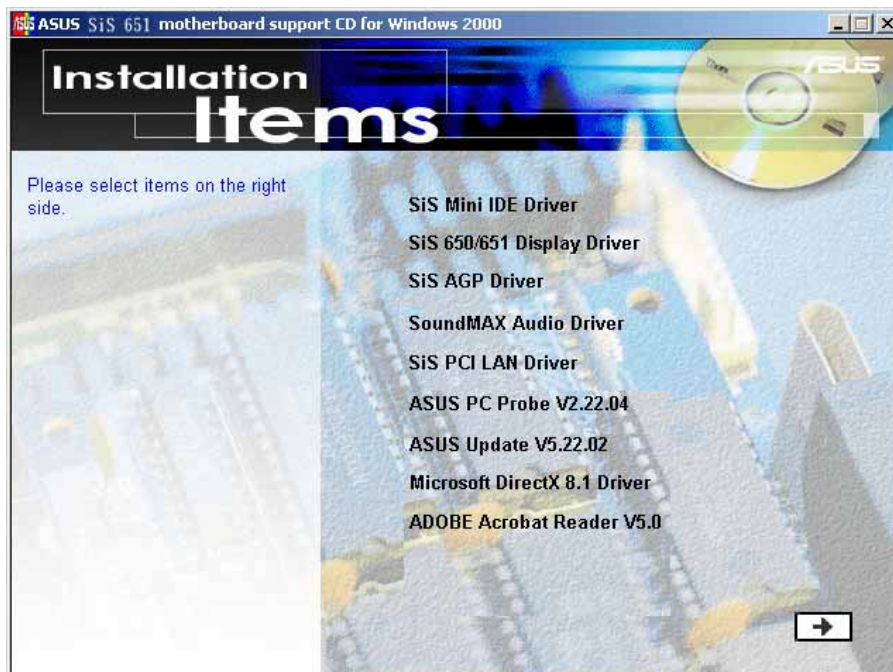

---

If **Autorun** is NOT enabled in your computer, browse the contents of the support CD to locate the file **ASSETUP.EXE** from the **BIN** folder. Double-click the **ASSETUP.EXE** to run the CD.

---

## 3.2.2 Installation items

The **Installation Items** window displays the available device drivers and applications that this motherboard supports. Install the necessary drivers to activate the devices on your motherboard.

### **SiS Mini IDE Driver**

Click this item to install the SiS Mini IDE driver.

### **SiS 650/651 Display Driver**

Click this item to install the 650/651 driver for the SiS chipset.

### **SiS AGP Driver**

Click this item to load the installation wizard and install the SiS AGP driver for the onboard VGA.

### **SoundMAX Audio Driver**

This item installs the AD1980 audio driver and the SoundMAX application.

### **SiS PCI LAN Driver**

Click this item to load the installation wizard and install the SiS PCI Lan driver for your network applications.

### **ASUS PC Probe VX.XX.XX**

This smart utility monitors the fan speed, CPU temperature, and system voltages, and alerts you on any detected problems. This utility helps you keep your computer in a healthy operating condition.

### **ASUS Update VX.XX.XX**

This program allows you to download the latest version of the BIOS from the ASUS website. Before using the ASUS Update, make sure that you have an Internet connection so you can connect to the ASUS website. See page 2-7 for ASUS Update installation and use.

### **Microsoft® DirectX 8.1 Driver**

This item installs the Microsoft® DirectX 8.1.

### **ADOBE Acrobat Reader V5.0**

This item installs the Adobe® Acrobat Reader® V.50. The Acrobat Reader® software is for viewing files saved in Portable Document Format (PDF).

Click the  button to display other installation items.



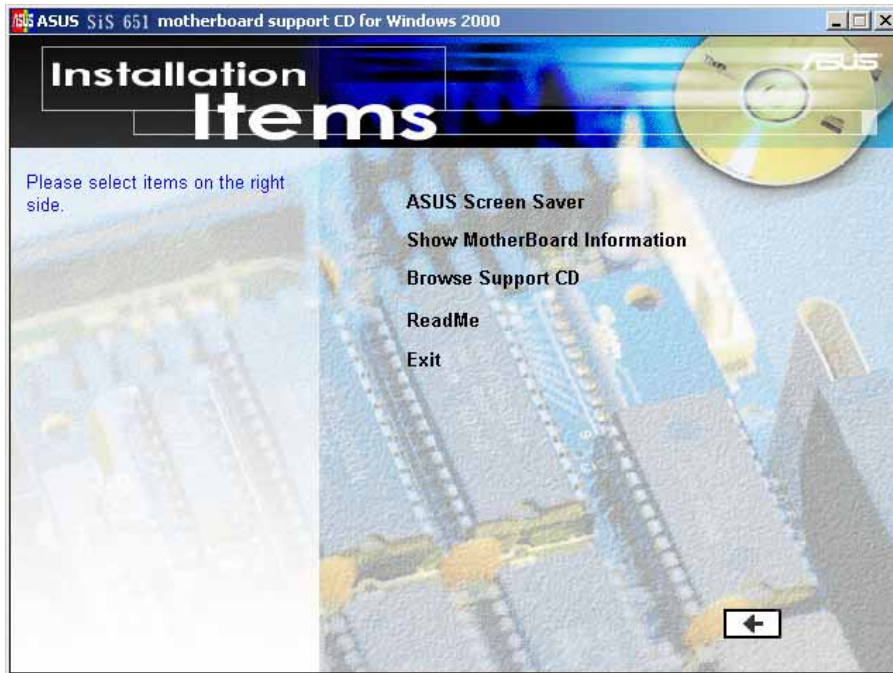

### **ASUS Screen Saver**

This item installs the ASUS screen saver.

### **Show Motherboard Information**

Click this item to display the general specifications for the P4SP-MX SE motherboard.

### **Browse Support CD**

Click this item to display the support CD contents.

### **Readme**

This item displays the support CD contents and a brief description of each in text format.

### **Exit**

Click this item to close the installation window.

Click the  button anytime to return to the previous window.



---

Screen display and utilities option may not be the same for other operating system version.

---