



***P4B533***

User Guide

**Motherboard**

**E1035**

**Revised Edition 1.04**

**May 2002**

**Copyright © 2002 ASUSTeK COMPUTER INC. All Rights Reserved.**

No part of this manual, including the products and software described in it, may be reproduced, transmitted, transcribed, stored in a retrieval system, or translated into any language in any form or by any means, except documentation kept by the purchaser for backup purposes, without the express written permission of ASUSTeK COMPUTER INC. ("ASUS").

Product warranty or service will not be extended if: (1) the product is repaired, modified or altered, unless such repair, modification or alteration is authorized in writing by ASUS; or (2) the serial number of the product is defaced or missing.

ASUS PROVIDES THIS MANUAL "AS IS" WITHOUT WARRANTY OF ANY KIND, EITHER EXPRESS OR IMPLIED, INCLUDING BUT NOT LIMITED TO THE IMPLIED WARRANTIES OR CONDITIONS OF MERCHANTABILITY OR FITNESS FOR A PARTICULAR PURPOSE. IN NO EVENT SHALL ASUS, ITS DIRECTORS, OFFICERS, EMPLOYEES OR AGENTS BE LIABLE FOR ANY INDIRECT, SPECIAL, INCIDENTAL, OR CONSEQUENTIAL DAMAGES (INCLUDING DAMAGES FOR LOSS OF PROFITS, LOSS OF BUSINESS, LOSS OF USE OR DATA, INTERRUPTION OF BUSINESS AND THE LIKE), EVEN IF ASUS HAS BEEN ADVISED OF THE POSSIBILITY OF SUCH DAMAGES ARISING FROM ANY DEFECT OR ERROR IN THIS MANUAL OR PRODUCT.

SPECIFICATIONS AND INFORMATION CONTAINED IN THIS MANUAL ARE FURNISHED FOR INFORMATIONAL USE ONLY, AND ARE SUBJECT TO CHANGE AT ANY TIME WITHOUT NOTICE, AND SHOULD NOT BE CONSTRUED AS A COMMITMENT BY ASUS. ASUS ASSUMES NO RESPONSIBILITY OR LIABILITY FOR ANY ERRORS OR INACCURACIES THAT MAY APPEAR IN THIS MANUAL, INCLUDING THE PRODUCTS AND SOFTWARE DESCRIBED IN IT.

Products and corporate names appearing in this manual may or may not be registered trademarks or copyrights of their respective companies, and are used only for identification or explanation and to the owners' benefit, without intent to infringe.

# Contents

Contents .....	iii
FCC/CDC statements .....	vi
Safety information .....	vii
About this guide .....	viii
How this guide is organized .....	viii
Conventions used in this guide .....	ix
Where to find more information .....	ix
ASUS contact information .....	x
P4B533 specifications summary .....	xi
<b>Chapter 1: Product introduction</b>	
1.1 Welcome! .....	1-1
1.2 Package contents .....	1-1
1.3 Special features .....	1-2
1.3.1 Product highlights .....	1-2
1.3.2 Value-added solutions .....	1-4
1.4 Motherboard overview .....	1-6
1.4.1 Major components .....	1-6
1.4.2 Core specifications .....	1-8
<b>Chapter 2: Hardware information</b>	
2.1 Motherboard installation .....	2-1
2.1.1 Placement direction .....	2-1
2.1.2 Screw holes .....	2-1
2.2 Motherboard layout .....	2-2
2.3 Before you proceed .....	2-3
2.4 Central Processing Unit (CPU) .....	2-4
2.4.1 Overview .....	2-4
2.4.2 Installing the CPU .....	2-5
2.4.3 Installing the heatsink and fan .....	2-7
2.4.4 Connecting the CPU fan cable .....	2-9
2.5 System memory .....	2-10
2.5.1 Overview .....	2-10
2.5.2 Memory configurations .....	2-11
2.5.3 Installing a DIMM .....	2-11
2.5.4 Removing a DIMM .....	2-12

# Contents

2.6	Expansion slots .....	2-13
2.6.1	Installing an expansion card .....	2-13
2.6.2	Configuring an expansion card .....	2-13
2.6.3	PCI slots .....	2-15
2.6.4	AGP slot .....	2-15
2.7	Switches and jumpers .....	2-16
2.8	Connectors .....	2-24

## Chapter 3: Powering up

3.1	Starting up for the first time .....	3-1
3.2	Vocal POST Messages .....	3-2
3.3	Powering off the computer .....	3-4

## Chapter 4: BIOS setup

4.1	Managing and updating your BIOS .....	4-1
4.1.1	Using ASUS EZ Flash to update the BIOS .....	4-1
4.1.2	Using AFLASH to update the BIOS .....	4-3
4.2	BIOS Setup program .....	4-7
4.2.1	BIOS menu bar .....	4-8
4.2.2	Legend bar .....	4-8
4.3	Main Menu .....	4-10
4.3.1	Primary and Secondary Master/Slave .....	4-12
4.3.2	Keyboard Features .....	4-16
4.4	Advanced Menu .....	4-17
4.4.1	Chip Configuration .....	4-21
4.4.2	I/O Device Configuration .....	4-24
4.4.3	PCI Configuration .....	4-26
4.5	Power Menu .....	4-28
4.5.1	Power Up Control .....	4-30
4.5.2	Hardware Monitor .....	4-32
4.6	Boot Menu .....	4-34
4.7	Exit Menu .....	4-36

# Contents

## Chapter 5: Software support

5.1	Install an operating system .....	5-1
5.2	Support CD information .....	5-1
5.2.1	Running the support CD .....	5-1
5.2.2	Main menu .....	5-2
5.2.3	Software menu .....	5-3
5.2.4	Drivers menu .....	5-5
5.2.5	DOS Utility menu .....	5-6
5.2.6	ASUS Contact Information .....	5-6
5.2.7	Other information .....	5-7
5.3	Software information .....	5-9
5.3.1	ASUS Update .....	5-9
5.3.2	ASUS MyLogo2™ .....	5-10
5.3.3	ASUS PC Probe .....	5-12
5.3.4	E-Color 3Deep .....	5-17
5.3.5	Winbond Voice Editor .....	5-20
5.3.6	Multi-Channel Audio Feature .....	5-24
	<b>Index .....</b>	<b>I-1</b>

# FCC/CDC statements

## Federal Communications Commission Statement

This device complies with FCC Rules Part 15. Operation is subject to the following two conditions:

- This device may not cause harmful interference, and
- This device must accept any interference received including interference that may cause undesired operation.

This equipment has been tested and found to comply with the limits for a Class B digital device, pursuant to Part 15 of the FCC Rules. These limits are designed to provide reasonable protection against harmful interference in a residential installation. This equipment generates, uses and can radiate radio frequency energy and, if not installed and used in accordance with manufacturer's instructions, may cause harmful interference to radio communications. However, there is no guarantee that interference will not occur in a particular installation. If this equipment does cause harmful interference to radio or television reception, which can be determined by turning the equipment off and on, the user is encouraged to try to correct the interference by one or more of the following measures:

- Reorient or relocate the receiving antenna.
- Increase the separation between the equipment and receiver.
- Connect the equipment to an outlet on a circuit different from that to which the receiver is connected.
- Consult the dealer or an experienced radio/TV technician for help.



---

The use of shielded cables for connection of the monitor to the graphics card is required to assure compliance with FCC regulations. Changes or modifications to this unit not expressly approved by the party responsible for compliance could void the user's authority to operate this equipment.

---

## Canadian Department of Communications Statement

This digital apparatus does not exceed the Class B limits for radio noise emissions from digital apparatus set out in the Radio Interference Regulations of the Canadian Department of Communications.

**This class B digital apparatus complies with Canadian ICES-003.**

# Safety information

## Electrical safety

- To prevent electrical shock hazard, disconnect the power cable from the electrical outlet before relocating the system.
- When adding or removing devices to or from the system, ensure that the power cables for the devices are unplugged before the signal cables are connected. If possible, disconnect all power cables from the existing system before you add a device.
- Before connecting or removing signal cables from the motherboard, ensure that all power cables are unplugged.
- Seek professional assistance before using an adapter or extension cord. These devices could interrupt the grounding circuit.
- Make sure that your power supply is set to the correct voltage in your area. If you are not sure about the voltage of the electrical outlet you are using, contact your local power company.
- If the power supply is broken, do not try to fix it by yourself. Contact a qualified service technician or your retailer.

## Operation safety

- Before installing the motherboard and adding devices on it, carefully read all the manuals that came with the package.
- Before using the product, make sure all cables are correctly connected and the power cables are not damaged. If you detect any damage, contact your dealer immediately.
- To avoid short circuits, keep paper clips, screws, and staples away from connectors, slots, sockets and circuitry.
- Avoid dust, humidity, and temperature extremes. Do not place the product in any area where it may become wet.
- Place the product on a stable surface.
- If you encounter technical problems with the product, contact a qualified service technician or your retailer.

# About this guide

This user guide contains the information you need when installing the ASUS P4B533 motherboard.

## How this guide is organized

This manual contains the following parts:

- **Chapter 1: Product introduction**

This chapter describes the features of the P4B533 motherboard. It includes brief descriptions of the special attributes of the motherboard and the new technology it supports.
- **Chapter 2: Hardware information**

This chapter lists the hardware setup procedures that you have to perform when installing system components. It includes description of the switches, jumpers, and connectors on the motherboard.
- **Chapter 3: Powering up**

This chapter describes the power up sequence and gives information on the BIOS beep codes.
- **Chapter 4: BIOS setup**

This chapter tells how to change system settings through the BIOS Setup menus. Detailed descriptions of the BIOS parameters are also provided.
- **Chapter 5: Software support**

This chapter describes the contents of the support CD that comes with the motherboard package.
- **Index**

This part contains an alphabetical list of the topics found in this document.



## Conventions used in this guide

To make sure that you perform certain tasks properly, take note of the following symbols used throughout this manual.



**WARNING:** Information to prevent injury to yourself when trying to complete a task.



**CAUTION:** Information to prevent damage to the components when trying to complete a task.



**IMPORTANT:** Information that you **MUST** follow to complete a task.



**NOTE:** Tips and additional information to aid in completing a task.

## Where to find more information

Refer to the following sources for additional information and for product and software updates.

### 1. ASUS Websites

The ASUS websites worldwide provide updated information on ASUS hardware and software products. The ASUS websites are listed in the ASUS Contact Information on page x.

### 2. Optional Documentation

Your product package may include optional documentation, such as warranty flyers, that may have been added by your dealer. These documents are not part of the standard package.

# ASUS contact information

## ASUSTeK COMPUTER INC. (Asia-Pacific)

Address: 150 Li-Te Road, Peitou, Taipei, Taiwan 112  
General Tel: +886-2-2894-3447  
General Fax: +886-2-2894-3449  
General Email: info@asus.com.tw

### *Technical Support*

MB/Others (Tel): +886-2-2890-7121 (English)  
Notebook (Tel): +886-2-2890-7122 (English)  
Desktop/Server (Tel): +886-2-2890-7123 (English)  
Support Fax: +886-2-2890-7698  
Support Email: tsd@asus.com.tw  
Web Site: www.asus.com.tw  
Newsgroup: cscnews.asus.com.tw

## ASUS COMPUTER INTERNATIONAL (America)

Address: 6737 Mowry Avenue, Mowry Business Center,  
Building 2, Newark, CA 94560, USA  
General Fax: +1-510-608-4555  
General Email: tmd1@asus.com

### *Technical Support*

Support Fax: +1-510-608-4555  
General Support: +1-502-995-0883  
Notebook Support: +1-877-918-ASUS (2787)  
Web Site: www.asus.com  
Support Email: tsd@asus.com

## ASUS COMPUTER GmbH (Europe)

Address: Harkortstr. 25, 40880 Ratingen, BRD, Germany  
General Fax: +49-2102-442066  
General Email: sales@asuscom.de (for marketing requests only)

### *Technical Support*

Support Hotline: MB/Others: +49-2102-9599-0  
Notebook (Tel): +49-2102-9599-10  
Support Fax: +49-2102-9599-11  
Support (Email): www.asuscom.de/de/support (for online support)  
Web Site: www.asuscom.de

# P4B533 specifications summary

<b>CPU</b>	Socket 478 for Intel® Pentium® 4 On-die 512KB L2 cache
<b>Chipset</b>	Intel 82845E MCH Intel 82801 DB ICH4
<b>Front Side Bus (FSB)</b>	533/400 MHz
<b>Memory</b>	3 x 184-pin DDR DIMM sockets for up to 2GB memory Supports PC2100/PC1600 unbuffered ECC/non-ECC DDR DIMMs
<b>Expansion slots</b>	1 x AGP 4X (1.5V only) 6 x PCI
<b>IDE</b>	2 x UltraDMA 100/66/33
<b>Audio (optional)</b>	C-Media 8738-MX 6-channel PCI audio controller
<b>Special features</b>	ASUS JumperFree™ mode ASUS POST Reporter™ ASUS EZ Plug™ ASUS MyLogo2 ASUS Q-Fan ASUS EZ Flash Power Loss Restart SFS (Stepless Frequency Selection) Adjustable CPU $V_{CORE}$ , and memory and AGP voltages Multi-language BIOS AGP warning LED
<b>Rear panel I/O</b>	1 x Parallel port 2 x Serial ports 1 x PS/2 keyboard port 1 x PS/2 mouse port 4 x USB 2.0/USB 1.1 ports Line In/Line Out/Microphone ports (optional)
<b>Internal I/O</b>	1 x USB 2.0/1.1 connector for 2 additional USB ports CPU/Power/Chassis fan connectors 20-pin/4-pin ATX power connectors IDE LED/Power LED connectors Chassis intrusion, SMBus, and SIR connectors GAME/MIDI connector S/PDIF In/Out connector CD/AUX/Modem audio connectors (optional) Front panel audio connector (optional)
<b>BIOS features</b>	4Mb Flash ROM, Award BIOS, TCAV, PnP, DMI2.0, WfM2.0, SM BIOS2.3, Multi-language BIOS, ASUS EZ Flash, ASUS MyLogo2

# P4B533 specifications summary

<b>Industry standard</b>	PCI 2.2, USB 2.0
<b>Manageability</b>	WfM 2.0, DMI 2.0, WOL/WOR by PME, chassis intrusion, SMBus
<b>Form Factor</b>	ATX form factor: 12 in x 8.6 in (30.5 cm x 21.9 cm)
<b>Support CD contents</b>	Device drivers ASUS PC Probe ASUS LiveUpdate Trend Micro™ PC-cillin 2002 anti-virus software CyberLink Power Player SE, VideoLive Mail

# *Chapter 1*

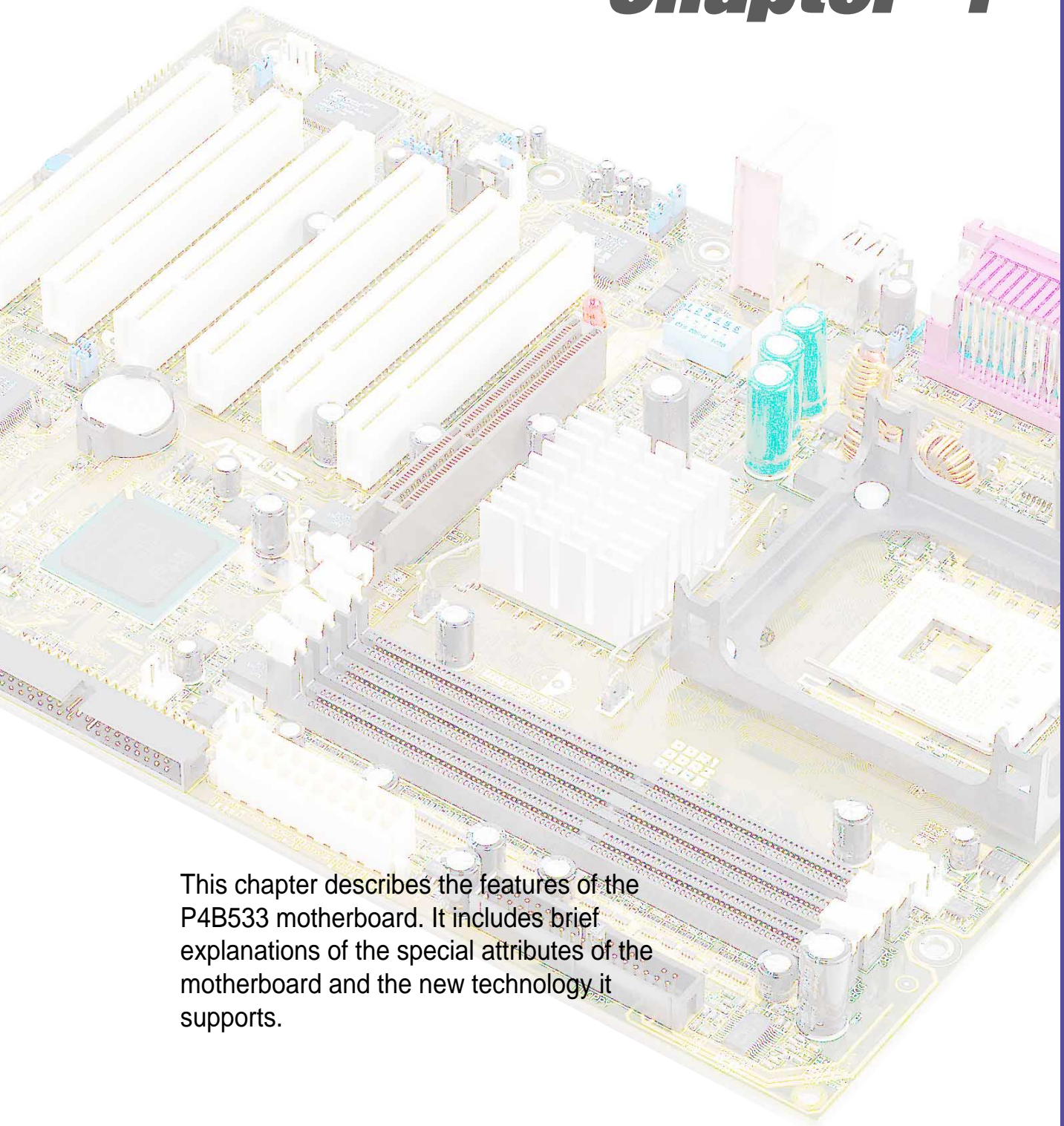

This chapter describes the features of the P4B533 motherboard. It includes brief explanations of the special attributes of the motherboard and the new technology it supports.

## **Product introduction**

## **Chapter summary**

<b>1.1</b>	<b>Welcome! .....</b>	<b>1-1</b>
<b>1.2</b>	<b>Package contents .....</b>	<b>1-1</b>
<b>1.3</b>	<b>Special features .....</b>	<b>1-2</b>
<b>1.4</b>	<b>Motherboard overview .....</b>	<b>1-6</b>

# 1.1 Welcome!

## Thank you for buying the ASUS® P4B533 motherboard!

The ASUS P4B533 motherboard delivers a host of new features and latest technologies making it another standout in the long line of ASUS quality motherboards!

The P4B533 incorporates the Intel® Pentium® 4 Processor in 478-pin package coupled with the Intel® 845E (Brookdale-E) chipset to set a new benchmark for an effective desktop platform solution.

Supporting up to 2GB of system memory with PC2100/1600 DDR SDRAM, high-resolution graphics via an AGP 4X slot, USB 2.0 capability, high-speed data transfers using the ATA100 protocol, and 6-channel PCI audio features, the P4B533 is your perfect vehicle to get ahead in the world of power computing!

Before you start installing the motherboard, and hardware devices on it, check the items in your package with the list below.

## 1.2 Package contents

Check your P4B533 package for the following items.

- ✓ ASUS P4B533 motherboard  
ATX form factor: 12 in x 8.6 in (30.5 cm x 21.9 cm)
- ✓ ASUS P4B533 series support CD
- ✓ ASUS USB 2.0/GAME module
- ✓ ASUS S/PDIF module (for audio models only)
- ✓ 80-conductor ribbon cable for UltraDMA/33/66/100 IDE drives
- ✓ 40-conductor IDE cable
- ✓ Ribbon cable for a 3.5-inch floppy drive
- ✓ Bag of extra jumper caps
- ✓ User Guide
- ✓ Quick Setup Guide and Reference Card (retail box only)
- ✓ Jumpers and Connectors Sticker (retail box only)



---

If any of the above items is damaged or missing, contact your retailer.

---

## 1.3 Special features

### 1.3.1 Product highlights

#### Latest processor technology

The P4B533 motherboard supports the latest Intel® Pentium® 4 Processor via a 478-pin surface mount ZIF socket. The Pentium 4 processor with 512KB L2 cache on 0.13 micron process features the Intel® NetBurst™ micro-architecture that includes hyper-pipelined technology, a rapid execution engine, a 533MHz system bus, and an execution trace cache to offer a significant increase in performance. See page 2-4 for more information.

#### DDR memory support

Employing the Double Data Rate (DDR) memory technology, the P4B533 motherboard supports up to 2GB of system memory using PC2100/1600 DDR DIMMs. The ultra-fast 266MHz memory bus doubles the speed of the PC133 SDRAM to deliver the required bandwidth for the latest 3D graphics, multimedia, and Internet applications. See page 2-10.

#### USB 2.0 technology

The motherboard implements the new Universal Serial Bus (USB) 2.0 specification, extending the connection speed from 12 Mbps on USB 1.1 to a fast 480 Mbps on USB 2.0. The higher bandwidth of USB 2.0 allows connection of devices such as high resolution video conferencing cameras, next generation scanners and printers, and fast storage units. USB 2.0 is backward compatible with USB 1.1. See page 2-29.

**NOTICE:** The Microsoft USB 2.0 driver has not been officially released as of the support CD production date. Please download the USB 2.0 driver from the Microsoft website ([www.microsoft.com](http://www.microsoft.com)) to upgrade your USB 1.1 ports to USB 2.0.

#### Digital audio interface

On audio models, a digital audio connector is onboard to accommodate the bundled Sony/Philips Digital Interface (S/PDIF) In/Out module, which supports coaxial interfaces. Experience 5.1-channel surround sound and enhanced 3D audio while playing DVDs and computer games. See page 2-32.



## ASUS EZ Plug™



This patented ASUS technology lets you use your existing power supply rather than buying a new ATX 12V power supply. The ASUS EZ Plug™ is a 4-pin auxiliary +12V connector mounted on the motherboard that connects a regular 4-pin device power connector from the power supply. This connector is necessary to provide the additional power required by the P4 CPU. See page 2-27.

## ASUS POST Reporter™



P4B533 offers a new exciting feature called the ASUS POST Reporter™ to provide friendly voice messages and alerts during the Power-On Self-Tests (POST). Through the system's internal speaker, or an added external speaker, you will hear the messages informing you of the system boot status and causes of boot errors, if any. The bundled Winbond Voice Editor software allows you to customize the voice messages, and provides multi-language support. See details on pages 4-25 and 5-20.

## ASUS MyLogo2™



This new feature present in the P4B533 motherboard allows you to personalize and add style to your system with customizable boot logos. See details on pages 4-35 and 5-10.

## ASUS Multi-language BIOS



The multi-language BIOS allows you to select the language of your choice from the available options. The localized BIOS menus allow you to configure easier and faster. Visit the ASUS website for information on the supported languages. See page 4-11 on how to select your desired language.

## ASUS EZ Flash BIOS

With the ASUS EZ Flash, you can easily update the system BIOS even before loading the operating system. No need to use a DOS-based utility or boot from a floppy disk. See details on page 4-1.

## ASUS Q-Fan feature

The ASUS Q-Fan technology smartly adjusts the fan speeds according to the system loading to ensure quiet, cool, and efficient operation. See details on page 4-32.

## 1.3.2 Value-added solutions

### Overclocking

The P4B533 overclocking features:

- adjustable CPU frequency multiple in BIOS using the ASUS JumperFree™ solution
- adjustable FSB/DDR, AGP/PCI frequency ratios
- adjustable CPU  $V_{\text{CORE}}$ , and DDR memory and AGP voltages
- Stepless Frequency Selection (SFS) for fine-tuning system bus frequency from 100MHz up to 200MHz at 1MHz increments

### Concurrent PCI

This feature allows multiple PCI transfers from PCI master buses to the memory and processor.

### Temperature, fan, and voltage monitoring

The CPU temperature is monitored by the ASUS ASIC to prevent overheating and damage. The system fan rotations per minute (RPM) is monitored for timely failure detection. The system voltage levels are monitored to ensure stable supply of current for critical components.

## **Dual function power switch**

While the system is ON, pressing the power switch for less than 4 seconds puts the system to sleep mode or to soft-off mode, depending on the BIOS setting. Pressing the power switch for more than 4 seconds lets the system enter the soft-off mode regardless of the BIOS setting.

## **ACPI ready**

The Advanced Configuration power Interface (ACPI) provides more energy saving features for operating systems that support OS Direct Power Management (OSPM).

## **Auto fan off**

The system fans power off automatically when the system is in sleep mode. This feature reduces both power consumption and system noise.

## **Chassis intrusion detection**

The motherboard supports chassis intrusion monitoring through the ASUS ASIC. A chassis intrusion event is retained in the system memory for more protection. See details on page 2-26.

## 1.4 Motherboard overview

Before you install the P4B533 motherboard, familiarize yourself with its physical configuration and available features to facilitate the motherboard installation and future upgrades. A sufficient knowledge of the motherboard specifications will also help you avoid mistakes that may damage the board and its components.

### 1.4.1 Major components

The following are the major components of the P4B533 motherboard as pointed out in the picture on page 1-7.

1. ASUS EZ Plug™ +12V connector
2. ATX 12V connector
3. DIP switches (DSW1)
4. CPU socket
5. North Bridge controller
6. DDR DIMM sockets
7. Floppy connector
8. ATX power connector
9. South Bridge controller
10. IDE connectors
11. DIP switches (DSW2)
12. Flash EEPROM
13. ASUS ASIC
14. Standby power LED
15. Audio controller (optional)
16. PCI slots
17. Super I/O controller
18. AGP warning LED
19. AGP slot
20. PS/2 mouse port
21. Parallel port
22. Line In jack (optional)
23. Line Out jack (optional)
24. Microphone jack (optional)
25. USB 2.0 ports 1 and 2
26. Serial ports
27. USB 2.0 ports 3 and 4
28. Keyboard port



---

See page 1-8 for the specifications of each component. Refer to Chapter 2 for detailed information on the components.

---

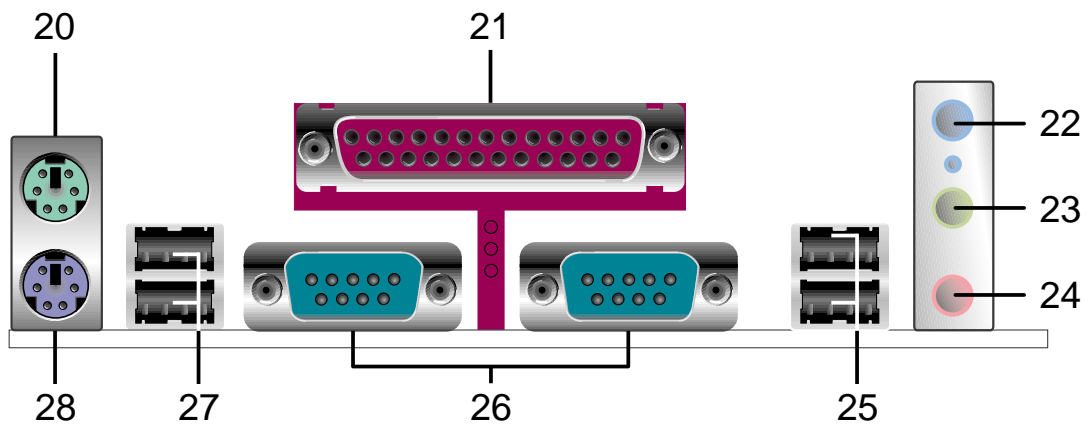
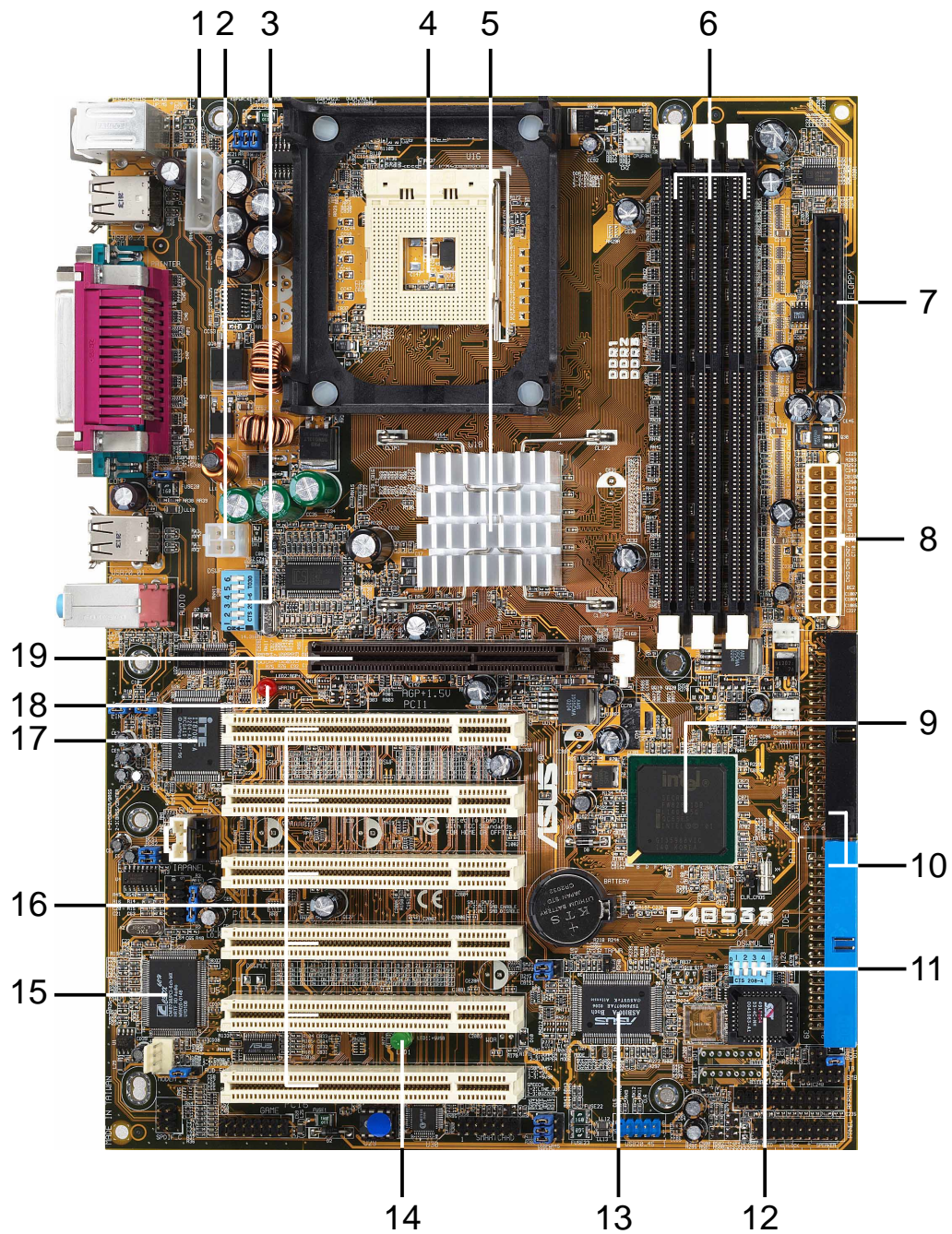



## 1.4.2 Core specifications

- 1 ASUS EZ Plug™ +12V connector.** This ASUS patented auxiliary power connector is used if you don't have an ATX +12V power supply. Connect a 4-pin device connector from a standard power supply to this connector to provide sufficient power to the CPU.
- 2 ATX 12V connector.** This power connector connects the 4-pin 12V plug from the ATX 12V power supply.
- 3 DIP switches (DSW1).** This 6-switch Dual Inline Package (DIP) allows you to set the CPU external frequency.
- 4 CPU socket.** A 478-pin surface mount, Zero Insertion Force (ZIF) socket for the Intel® Pentium® 4 Processor, with 533/400 MHz system bus that allows 4.3GB/s and 3.2GB/s data transfer rates, respectively.
- 5 North bridge controller.** The Intel® 845E Memory Controller Hub (MCH) provides the processor interface with 533/400MHz frequency, system memory interface at 133/100MHz operation, and 1.5V AGP interface that supports AGP 2.0 specification including 2X/4X Fast Write protocol. The MCH interconnects to the south bridge ICH4 via the Intel proprietary Hub Interface.
- 6 DDR DIMM sockets.** These three 184-pin DIMM sockets support up to 2GB system memory using unbuffered ECC or non-ECC PC2100/1600 DDR DIMMs.
- 7 Floppy disk connector.** This connector accommodates the provided ribbon cable for the floppy disk drive. One side of the connector is slotted to prevent incorrect insertion of the floppy disk cable.
- 8 ATX power connector.** This 20-pin connector connects to an ATX +12V power supply. The power supply must have at least 1A on the +5V standby lead (+5VSB).
- 9 South bridge controller.** The fourth-generation Intel I/O Controller Hub (ICH4) is a subsystem that integrates various I/O functions including 2-channel ATA/100 bus master IDE controller, up to six USB 2.0/1.1 ports, I/O APIC, SMBus 2.0 controller, LPC interface, AC'97 2.2 interface, PCI 2.2 interface, and integrated LAN controller. The ICH4 also contains the necessary arbitration and buffering for efficient utilization of these interfaces.

- 10 IDE connectors.** These dual-channel bus master IDE connectors support up to four Ultra DMA/100/66, PIO Modes 3 & 4 IDE devices. Both the primary (blue) and secondary (black) connectors are slotted to prevent incorrect insertion of the IDE ribbon cable.
- 11 DIP switches (DSW2).** This 4-switch Dual Inline Package (DIP) allows you to select the CPU frequency multiple.
- 12 Flash EEPROM.** This 4Mb firmware contains the programmable BIOS program.
- 13 ASUS ASIC.** This chip performs multiple system functions that include hardware and system voltage monitoring, IRQ routing, among others.
- 14 Standby power LED.** This LED lights up if there is a standby power on the motherboard. This LED acts as a reminder to turn off the system power before plugging or unplugging devices.
- 15 Audio controller.** This C-Media 6-channel PCI audio chip supports legacy audio and HRTF 3D positional audio functions. The chip also supports 24-bit S/PDIF In (0.5~5V) and S/PDIF Out (44.1K and 48K formats) professional digital audio interface, and one MPU-401 UART mode compatible MIDI/game port.  
*(on audio models only)*
- 16 PCI slots.** These six 32-bit PCI 2.2 expansion slots support bus master PCI cards like SCSI or LAN cards with 133MB/s maximum throughput.
- 17 Super I/O controller.** This Low Pin Count (LPC) interface provides the commonly used Super I/O functionality. The chipset supports a high-performance floppy disk controller for a 360K/720K/1.44M/2.88M floppy disk drive, a multi-mode parallel port, two standard compatible UARTs, a Standard Infrared (SIR), and a Flash ROM interface.
- 18 AGP warning LED.** Serving as a smart burn-out protection for the motherboard, this red LED lights up if you plug in any 3.3V AGP card into the AGP slot. When this LED is lit, there is no way you can turn on the system power even if you press the power button.
- 19 AGP slot.** This Accelerated Graphics Port (AGP) slot supports 1.5V AGP4X mode graphics cards for 3D graphical applications.

- 20** **PS/2 mouse port.** This green 6-pin connector is for a PS/2 mouse.
- 21** **Parallel port.** This 25-pin port connects a parallel printer, a scanner, or other devices.
- 22** **Line In jack.** This Line In (light blue) jack connects a tape player or other audio sources. In 6-channel mode, the function of this jack becomes Rear Speaker Out. *(on audio models only)*
- 23** **Line Out jack.** This Line Out (lime) jack connects a headphone or a speaker. In 6-channel mode, the function of this jack becomes Front Speaker Out. *(on audio models only)*
- 24** **Microphone jack.** This Mic (pink) jack connects a microphone. In 6-channel mode, the function of this jack becomes Bass/Center. *(on audio models only)*
- 25** **USB 2.0 ports 1 and 2.** These two 4-pin Universal Serial Bus (USB) ports are available for connecting USB 2.0 devices.
- 26** **Serial ports.** These two 9-pin COM1/COM2 ports are for pointing devices or other serial devices.
- 27** **USB 2.0 ports 3 and 4.** These two 4-pin Universal Serial Bus (USB) ports are available for connecting USB 2.0 devices.
- 28** **PS/2 keyboard port.** This purple 6-pin connector is for a PS/2 keyboard.



# *Chapter 2*

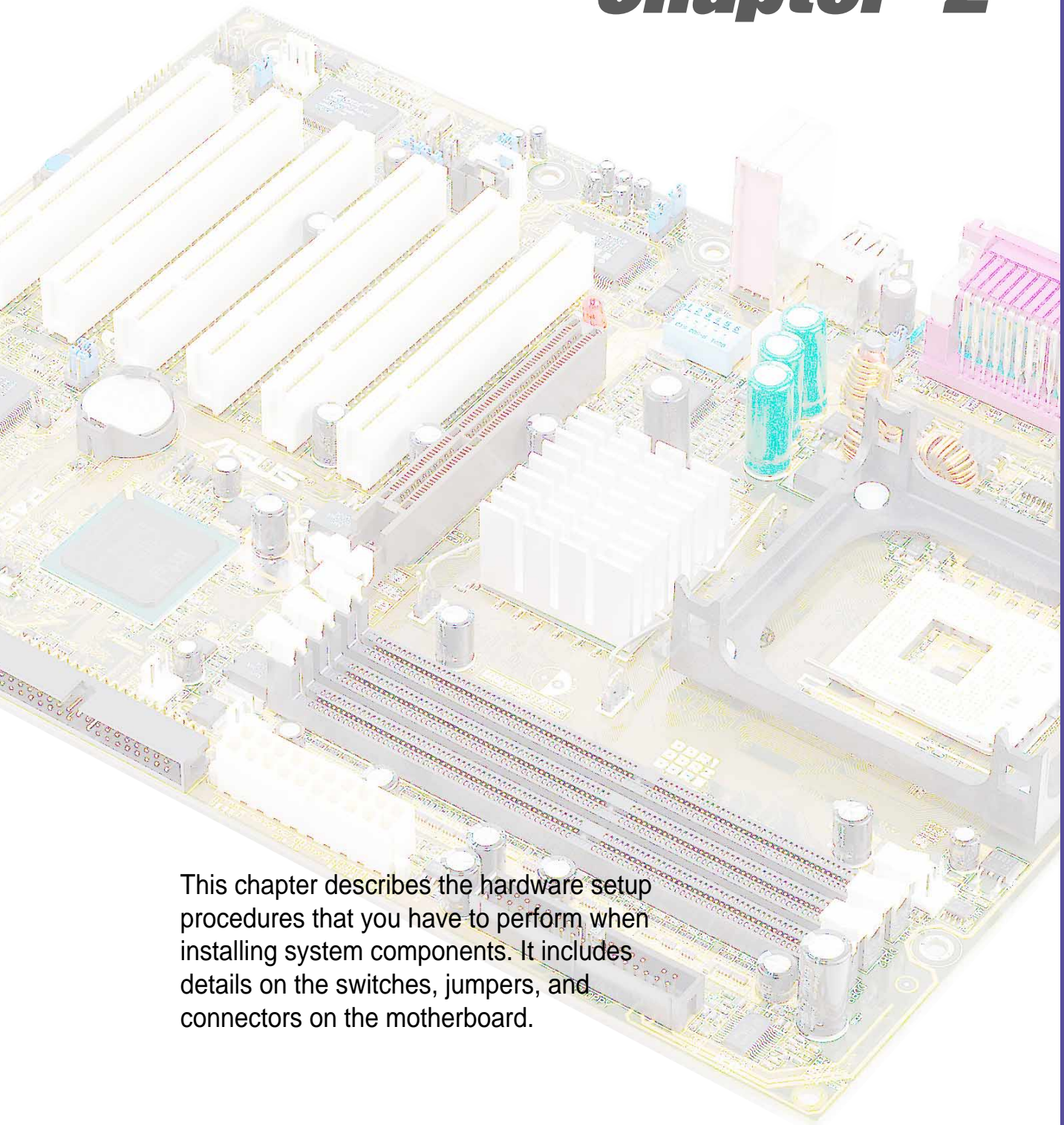

This chapter describes the hardware setup procedures that you have to perform when installing system components. It includes details on the switches, jumpers, and connectors on the motherboard.

## **Hardware information**

## **Chapter summary**

<b>2.1</b>	<b>Motherboard installation .....</b>	<b>2-1</b>
<b>2.2</b>	<b>Motherboard layout .....</b>	<b>2-2</b>
<b>2.3</b>	<b>Before you proceed .....</b>	<b>2-3</b>
<b>2.4</b>	<b>Central Processing Unit (CPU) .....</b>	<b>2-4</b>
<b>2.5</b>	<b>System memory .....</b>	<b>2-10</b>
<b>2.6</b>	<b>Expansion slots .....</b>	<b>2-13</b>
<b>2.7</b>	<b>Switches and jumpers .....</b>	<b>2-16</b>
<b>2.8</b>	<b>Connectors .....</b>	<b>2-24</b>

## 2.1 Motherboard installation

Before you install the motherboard, study the configuration of your chassis to ensure that the motherboard fits into it. The P4B533 uses the ATX form factor that measures 12 inches x 8.6 inches (30.5 x 21.9 cm), a standard fit for most chassis.



Make sure to unplug the power cord before installing or removing the motherboard. Failure to do so may cause you physical injury and damage motherboard components.

### 2.1.1 Placement direction

When installing the motherboard, make sure that you place it into the chassis in the correct orientation. The edge with external ports goes to the rear part of the chassis as indicated in the image below.

### 2.1.2 Screw holes

Place six (6) screws into the holes indicated by circles to secure the motherboard to the chassis.



Do not overtighten the screws! Doing so may damage the motherboard.

Place this side towards  
the rear of the chassis

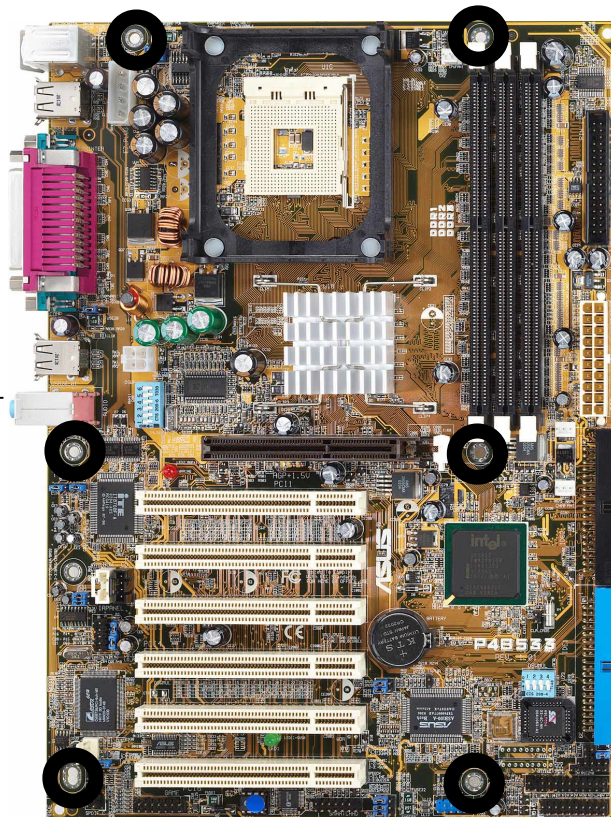

## 2.2 Motherboard layout

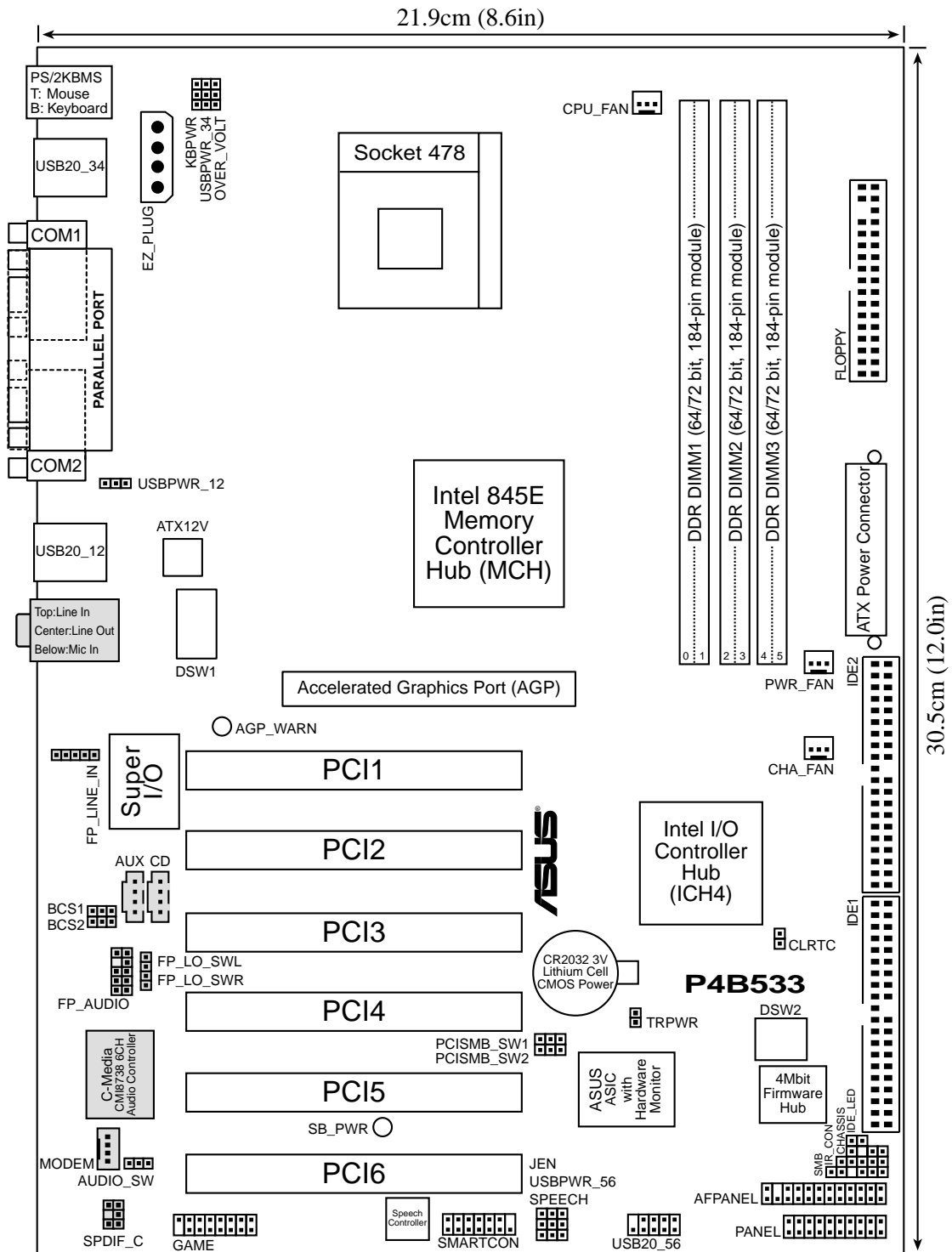

The audio features are optional. These components are grayed out in the above motherboard layout.



## 2.3 Before you proceed

Take note of the following precautions before you install motherboard components or change any motherboard settings.



1. Unplug the power cord from the wall socket before touching any component.
2. Use a grounded wrist strap or touch a safely grounded object or to a metal object, such as the power supply case, before handling components to avoid damaging them due to static electricity.
3. Hold components by the edges to avoid touching the ICs on them.
4. Whenever you uninstall any component, place it on a grounded antistatic pad or in the bag that came with the component.
5. **Before you install or remove any component, ensure that the ATX power supply is switched off or the power cord is detached from the power supply.** Failure to do so may cause severe damage to the motherboard, peripherals, and/or components.



When lit, the green LED (SB\_PWR) indicates that the system is ON, in sleep mode, or in soft-off mode, a reminder that you should shut down the system before removing or plugging in any motherboard component.

The red LED (AGP\_WARN) is a smart protection from motherboard burn out caused by an incorrect AGP card. If you plug in any 3.3V AGP card into the 1.5V AGP slot, this LED lights up thus preventing the system to power up. This LED remains off if you plug in a 1.5V AGP card.

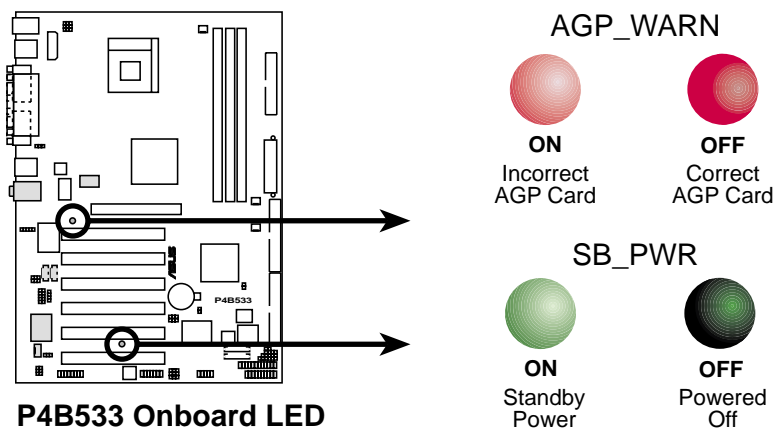

## 2.4 Central Processing Unit (CPU)

### 2.4.1 Overview

The motherboard comes with a surface mount 478-pin Zero Insertion Force (ZIF) socket. The socket is designed for the Intel Pentium 4 Processor in the 478-pin package with 512KB L2 cache on 0.13 micron process. This processor includes the Intel® NetBurst™ micro-architecture that features the hyper-pipelined technology, rapid execution engine, 533/400MHz system bus, and execution trace cache. Together, these attributes improve system performance by allowing higher core frequencies, faster execution of integer instructions, and data transfer rates of 4.2GB/s and 3.2GB/s.

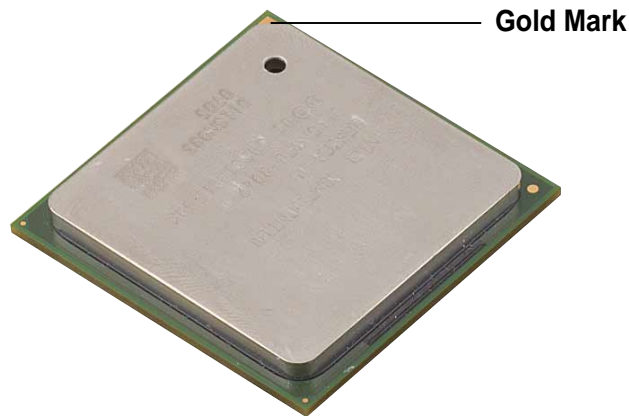

Note in the illustration that the CPU has a gold triangular mark on one corner. This mark indicates the processor Pin 1 that should match a specific corner of the CPU socket.



---

Incorrect installation of the CPU into the socket may bend the pins and severely damage the CPU!

---

## 2.4.2 Installing the CPU

Follow these steps to install a CPU.

1. Locate the 478-pin ZIF socket on the motherboard.

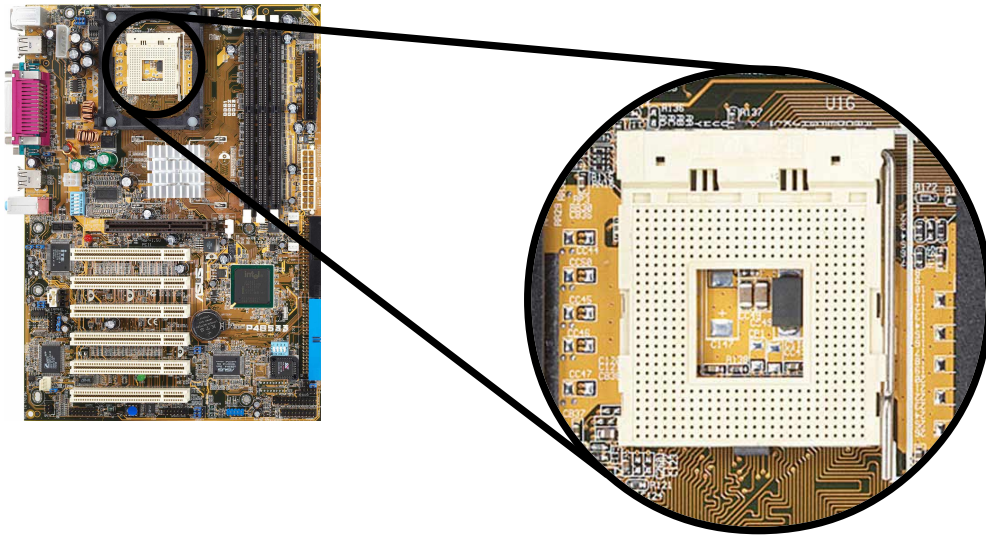

2. Unlock the socket by pressing the lever sideways, then lift it up to a 90°-100° angle.

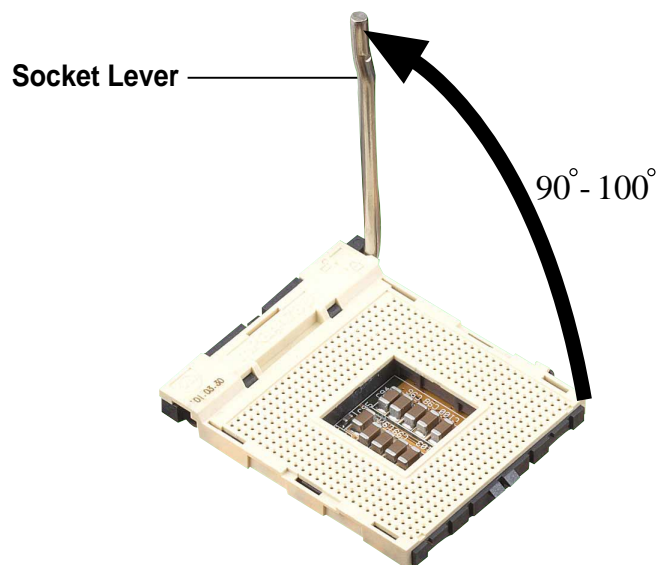

---

Make sure that the socket lever is lifted up to 90°-100° angle, otherwise the CPU does not fit in completely.

---

3. Position the CPU above the socket such that its marked corner matches the base of the socket lever.
4. Carefully insert the CPU into the socket until it fits in place.



---

The CPU fits only in one correct orientation. DO NOT force the CPU into the socket to prevent bending the pins and damaging the CPU!

---

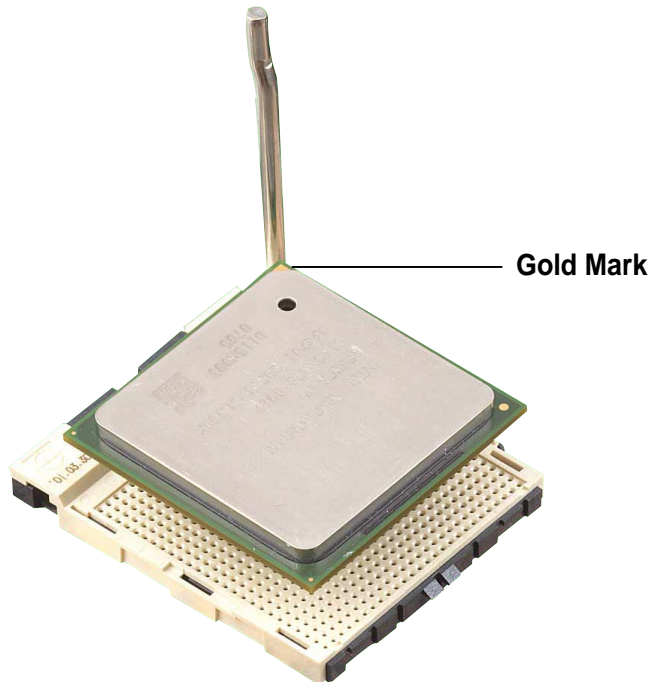

5. When the CPU is in place, press it firmly on the socket while you push down the socket lever to secure the CPU. The lever clicks on the side tab to indicate that it is locked.

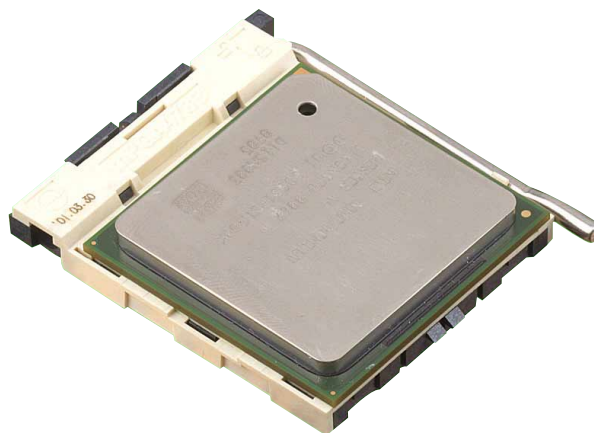



## 2.4.3 Installing the heatsink and fan

The Intel® Pentium® 4 Processor requires a specially designed heatsink and fan assembly to ensure optimum thermal condition and performance.



---

When you buy a boxed Intel Pentium 4 Processor, the package includes the heatsink, fan, and retention mechanism.

In case you buy a CPU separately, make sure that you use only Intel certified heatsink and fan.

---

Follow these steps to install the CPU heatsink and fan.

1. Place the heatsink on top of the installed CPU, making sure that the heatsink fits properly on the retention module base.



---

The retention module base is already installed on the motherboard upon purchase.

You do not have to remove the retention module base when installing the CPU or installing other motherboard components.

---

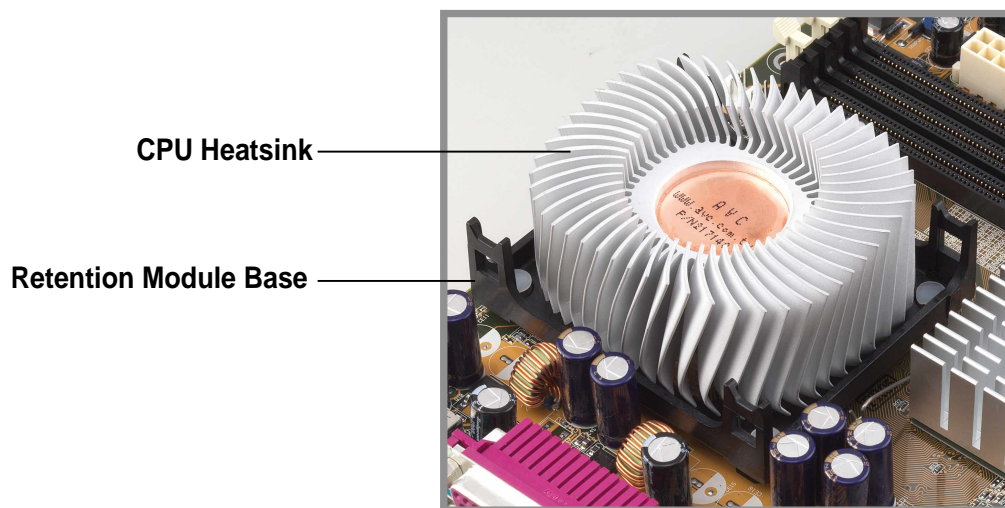

---

Your boxed Intel Pentium 4 Processor package should come with installation instructions for the CPU, heatsink, and the retention mechanism. If the instructions in this section do not match the CPU documentation, follow the latter.

---

2. Position the fan with the retention mechanism on top of the heatsink. Align and snap the four hooks of the retention mechanism to the holes on each corner of the module base.



---

Make sure that the fan and retention mechanism assembly perfectly fits the heatsink and module base, otherwise you cannot snap the hooks into the holes.

---

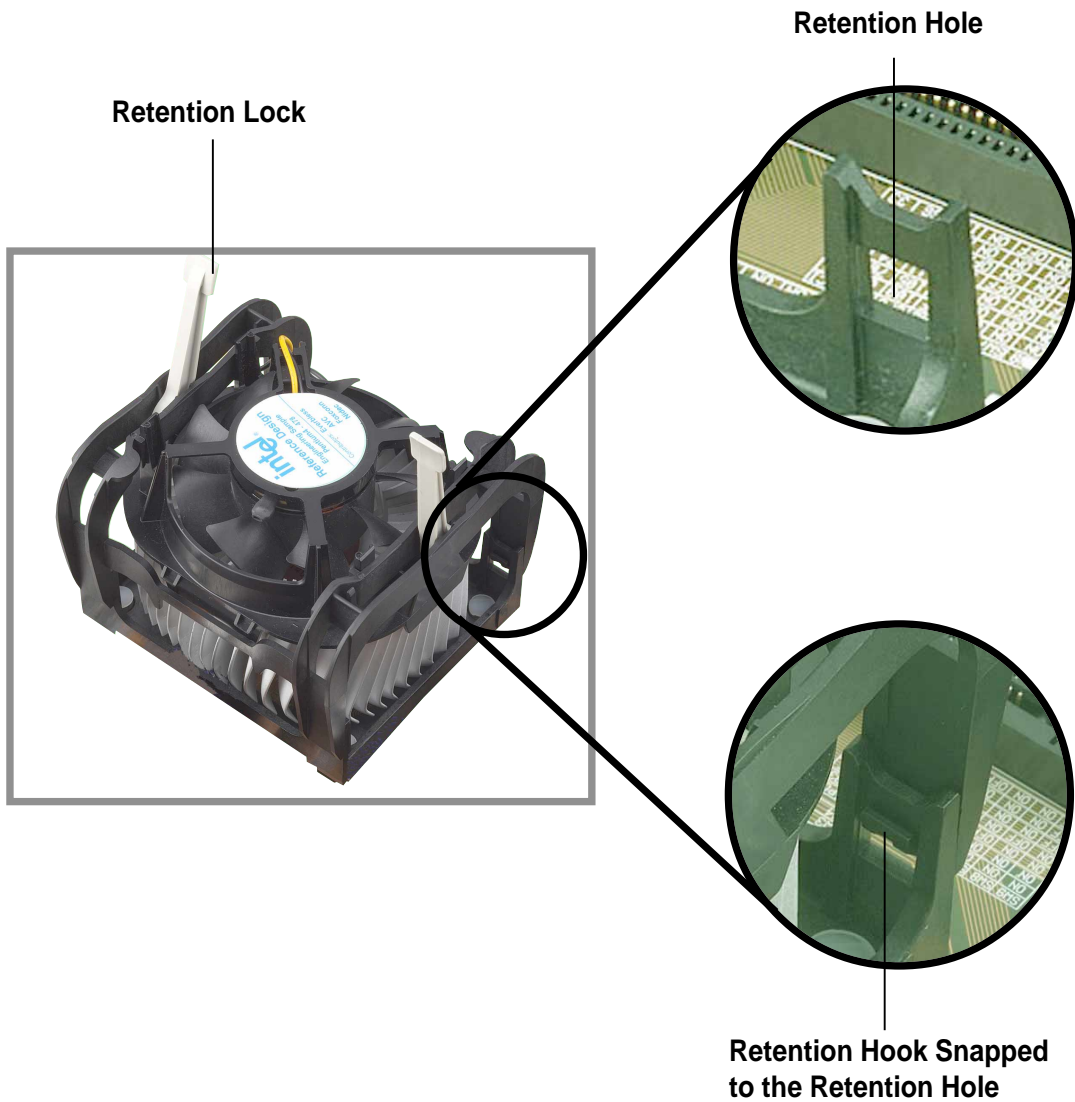

---

Keep the retention locks lifted upward while fitting the retention mechanism to the module base.

---

3. Push down the locks on the retention mechanism to secure the heatsink and fan to the module base.



---

When secure, the retention locks should point to opposite directions.

---



## 2.4.4 Connecting the CPU fan cable

When the fan, heatsink, and the retention mechanism are in place, connect the CPU fan cable to the connector on the motherboard labeled CPU\_FAN.

CPU Fan Connector  
(CPU\_FAN)

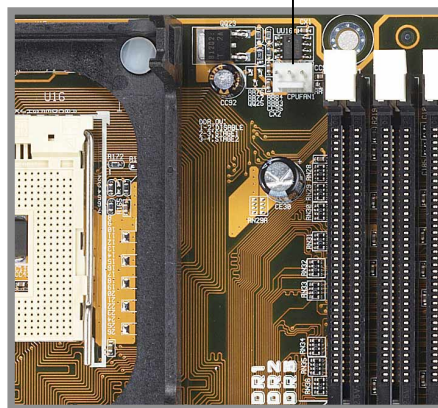

---

Don't forget to connect the CPU fan connector! Hardware monitoring errors may occur if you fail to plug this connector.

---

## 2.5 System memory

### 2.5.1 Overview

The motherboard comes with three Double Data Rate (DDR) Dual Inline Memory Module (DIMM) sockets. These sockets support up to 2GB system memory using 184-pin unbuffered ECC or non-ECC PC2100/1600 DIMMs.

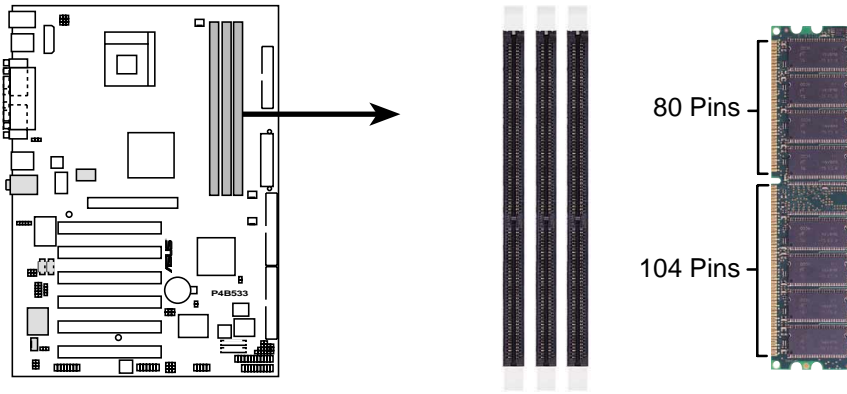

**P4B533 184-Pin DDR DIMM Sockets**



A DDR DIMM is keyed with a notch so that it fits in only one direction. **DO NOT** force a DIMM into a socket to avoid damaging the DIMM.

The DDR SDRAM technology evolved from the mainstream PC66, PC100, PC133 memory known as Single Data Rate (SDR) SDRAM. DDR memory however, has the ability to perform two data operations in one clock cycle, thus providing twice the throughput of SDR memory. For example, a 200MHz DDR DIMM will support a 100MHz memory bus, and a 266MHz DDR DIMM will support a 133MHz memory bus.

DDR Data Transfer Rate		DDR Base Frequency
266MHz	➔	133MHz
200MHz	➔	100MHz

A DDR DIMM has the same physical dimensions as an SDR DIMM, but it has a 184-pin footprint compared to the 168-pin of the SDR DIMM. Also, a DDR DIMM is single notched while an SDR DIMM is double notched. Therefore, a DDR DIMM is not backward compatible with SDR, and should be installed only in a socket specially designed for DDR DIMMs.

## 2.5.2 Memory configurations

You may install any DDR DIMMs with 64MB, 128MB, 256MB, 512MB, and 1GB densities into the DIMM sockets.



Use only the following combinations to install DDR DIMMs. Otherwise, the system may not boot up.

DDR DIMM1 (Rows 0&1)	DDR DIMM2 (Rows 2&3)	DDR DIMM3 (Rows 3&2)
SS/DS	DS	None
SS/DS	SS	SS

\* SS - Single-sided DIMM  
DS - Double-sided DIMM



DDR DIMM sockets 2 and 3 share the same rows, so if you install a double-sided DIMM into DIMM2 socket, you must leave DIMM3 socket empty. However, you may install single-sided DIMMs into DIMM2 and DIMM3 sockets at the same time.

## 2.5.3 Installing a DIMM



Make sure to unplug the power supply before adding or removing DIMMs or other system components. Failure to do so may cause severe damage to both the motherboard and the components.

Follow these steps to install a DIMM.

1. Unlock a DIMM socket by pressing the retaining clips outward.
2. Align a DIMM on the socket such that the notch on the DIMM matches the break on the socket.

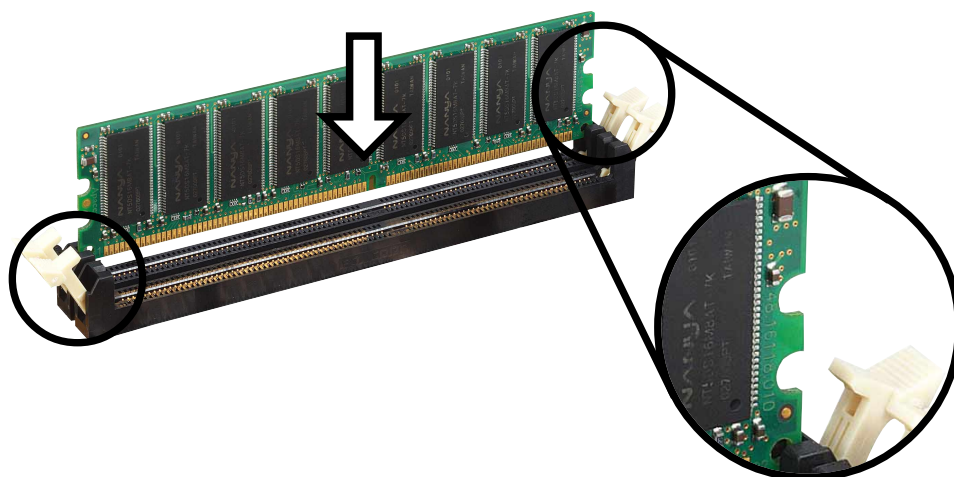

Unlocked Retaining Clip



3. Firmly insert the DIMM into the socket until the retaining clips snap back in place and the DIMM is properly seated.

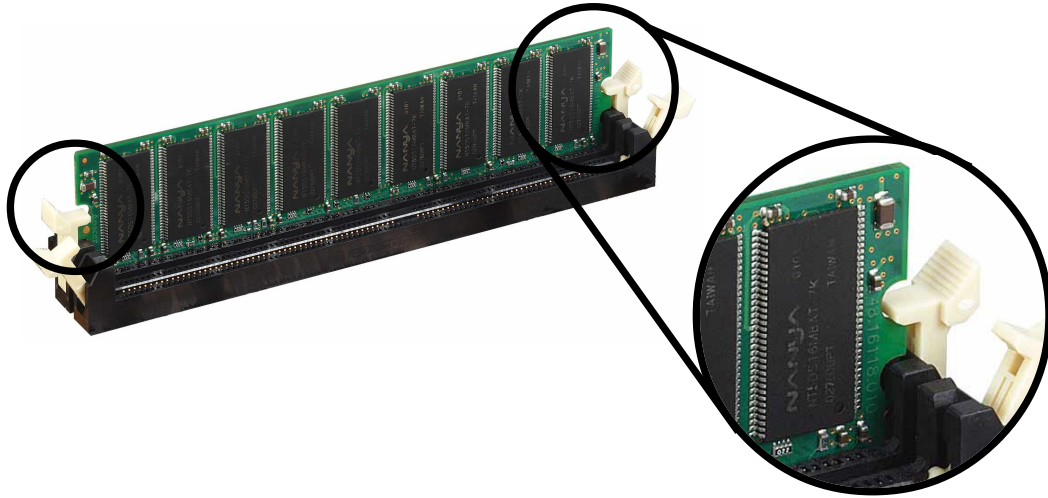

Locked Retaining Clip

## 2.5.4 Removing a DIMM

Follow these steps to remove a DIMM.

1. Simultaneously press the retaining clips outward to unlock the DIMM.



---

Support the DIMM lightly with your fingers when pressing the retaining clips. The DIMM might get damaged when it flips out with extra force.

---

2. Remove the DIMM from the socket.

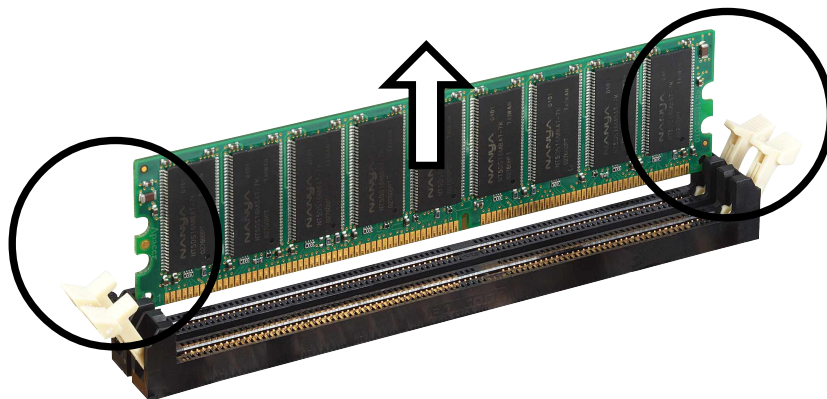

## 2.6 Expansion slots

In the future, you may need to install expansion cards. The motherboard has six PCI slots and one Accelerated Graphics Port (AGP) slot. The following sub-sections describe the slots and the expansion cards that they support.



---

Make sure to unplug the power cord before adding or removing expansion cards. Failure to do so may cause you physical injury and damage motherboard components.

---

### 2.6.1 Installing an expansion card

Follow these steps to install an expansion card.

1. Before installing the expansion card, read the documentation that came with it and make the necessary hardware settings for the card.
2. Remove the system unit cover (if your motherboard is already installed in a chassis).
3. Remove the bracket opposite the slot that you intend to use. Keep the screw for later use.
4. Align the card connector with the slot and press firmly until the card is completely seated on the slot.
5. Secure the card to the chassis with the screw you removed earlier.
6. Replace the system cover.

### 2.6.2 Configuring an expansion card

After installing the expansion card, configure it by adjusting the software settings.

1. Turn on the system and change the necessary BIOS settings, if any. See Chapter 4 for information on BIOS setup.
2. Assign an IRQ to the card. Refer to the tables on the next page.
3. Install the software drivers for the expansion card.

## Standard Interrupt Assignments

IRQ	Priority	Standard Function
0	1	System Timer
1	2	Keyboard Controller
2	N/A	Programmable Interrupt
3*	11	Communications Port (COM2)
4*	12	Communications Port (COM1)
5*	13	Sound Card (sometimes LPT2)
6	14	Floppy Disk Controller
7*	15	Printer Port (LPT1)
8	3	System CMOS/Real Time Clock
9*	4	ACPI Mode when used
10*	5	IRQ Holder for PCI Steering
11*	6	IRQ Holder for PCI Steering
12*	7	PS/2 Compatible Mouse Port
13	8	Numeric Data Processor
14*	9	Primary IDE Channel
15*	10	Secondary IDE Channel

\* These IRQs are usually available for ISA or PCI devices.

## IRQ assignments for this motherboard

	A	B	C	D	E	F	G	H
PCI slot 1	—	—	—	—	—	shared	—	—
PCI slot 2	—	—	—	—	—	—	used	—
PCI slot 3	—	—	—	—	—	—	—	shared
PCI slot 4	—	—	—	—	used	—	—	—
PCI slot 5	—	—	—	—	—	shared	—	—
PCI slot 6	—	—	shared	—	—	—	—	—
AGP slot	shared	—	—	—	—	—	—	—
Onboard USB controller HC0	shared	—	—	—	—	—	—	—
Onboard USB controller HC1	—	—	—	used	—	—	—	—
Onboard USB controller HC2	—	—	shared	—	—	—	—	—
Onboard USB 2.0 controller	—	—	—	—	—	—	—	shared
Onboard Audio	—	—	—	—	—	shared	—	—



When using PCI cards on shared slots, ensure that the drivers support “Share IRQ” or that the cards do not need IRQ assignments. Otherwise, conflicts will arise between the two PCI groups, making the system unstable and the card inoperable.



## 2.6.3 PCI slots

There are six 32-bit PCI slots in this motherboard. The slots support PCI cards such as a LAN card, SCSI card, USB card, and other cards that comply with PCI specifications. The following figure shows a LAN card installed on a PCI slot.

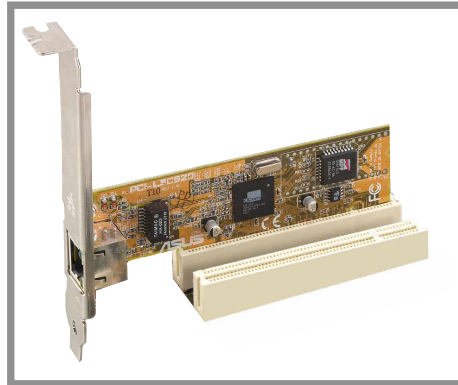

## 2.6.4 AGP slot

This motherboard has an Accelerated Graphics Port (AGP) slot that supports +1.5V AGP cards. When you buy an AGP card, make sure that you ask for one with +1.5V specification. Note the notches on the card golden fingers to ensure that they fit the AGP slot on your motherboard.

If you installed an incorrect AGP card, such as a SiS305-based AGP card or any other 3.3V AGP card, the onboard red LED (AGP\_WARN) lights up, an indication that the card is not supported on the motherboard. As long as this LED is lighted, you cannot turn on the system power even if you press the power button, thus preventing permanent damage to the motherboard.



---

Install only 1.5V AGP cards on this motherboard!

---

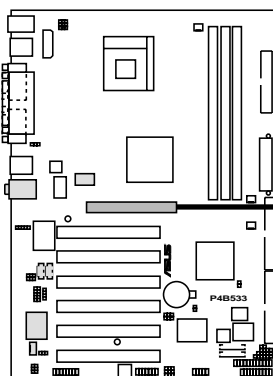

**P4B533 Accelerated Graphics Port (AGP)**

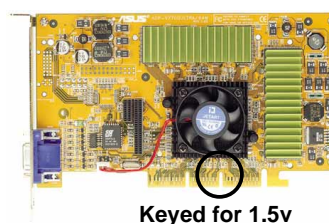

## 2.7 Switches and jumpers

The motherboard frequency is adjusted through the DIP switches. The white block represents the switch position. The illustration below shows the ON and OFF positions of the switches.

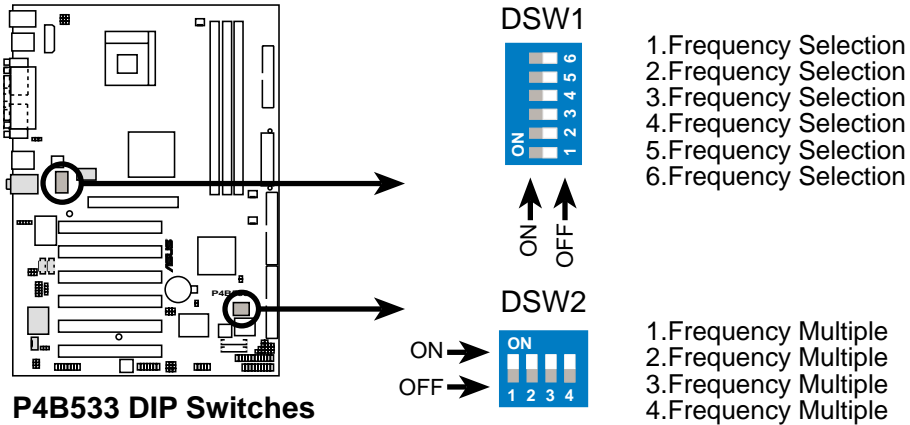

The JEN jumper must be set to pins 2-3 (jumper mode) if you wish to use the DIP switches. Otherwise, setting the switches does not produce any effect.

### 1. JumperFree™ mode (JEN)

This jumper allows you to enable or disable the JumperFree™ mode. The JumperFree mode allows you to change CPU settings through the BIOS setup instead of using the DIP switches.

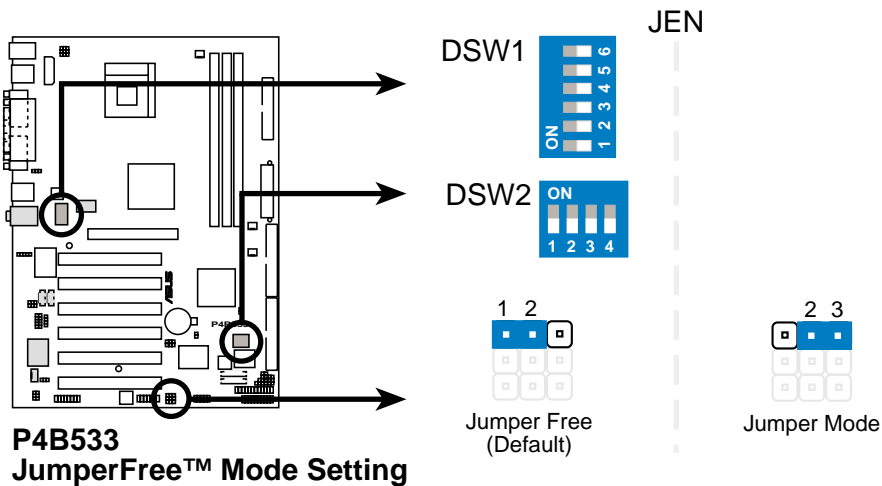

The JEN jumper is set in conjunction with the DIP switches. In JumperFree mode, set all the DIP switches to OFF.

In jumper mode, set the switches as shown in item 2 (CPU Core:Bus frequency multiple) and item 3 (CPU external frequency selection).

## 2. CPU Core:Bus frequency multiple (DSW2 Switches 1-4)

This option sets the frequency multiple between the CPU internal and external frequencies. This must be set in conjunction with the CPU Bus Frequency.

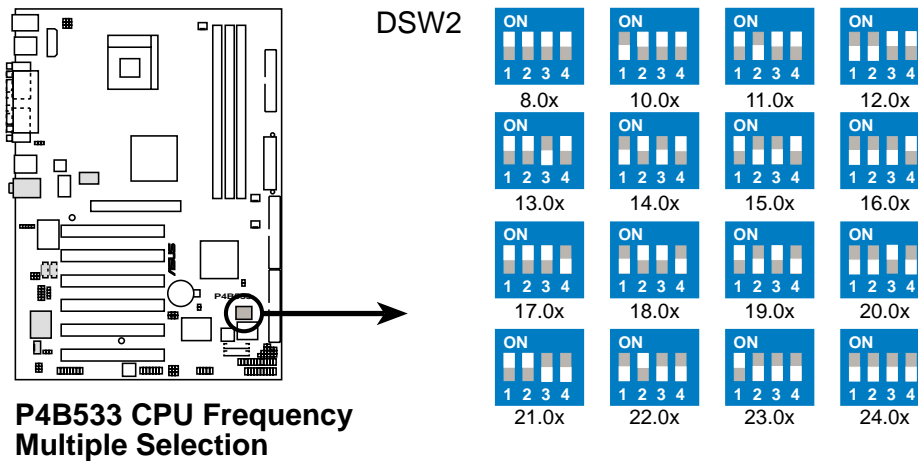

Make sure that the JEN jumper is set to jumper mode before setting the above switches.

The option to set the CPU core:bus frequency multiple is available only on unlocked CPUs. If you are using a locked CPU, setting the switches does not produce any effect.

### 3. CPU external frequency selection (DSW1 Switches 1-6)

This option tells the clock generator what frequency to send the CPU. This allows the selection of the CPU's external frequency (or Bus Clock). The BUS Clock multiplied by the Frequency Multiple equals the CPU's internal frequency (the advertised CPU speed).



To select the CPU external frequency using the DIP switches, ensure that the JEN jumper is set to jumper mode.

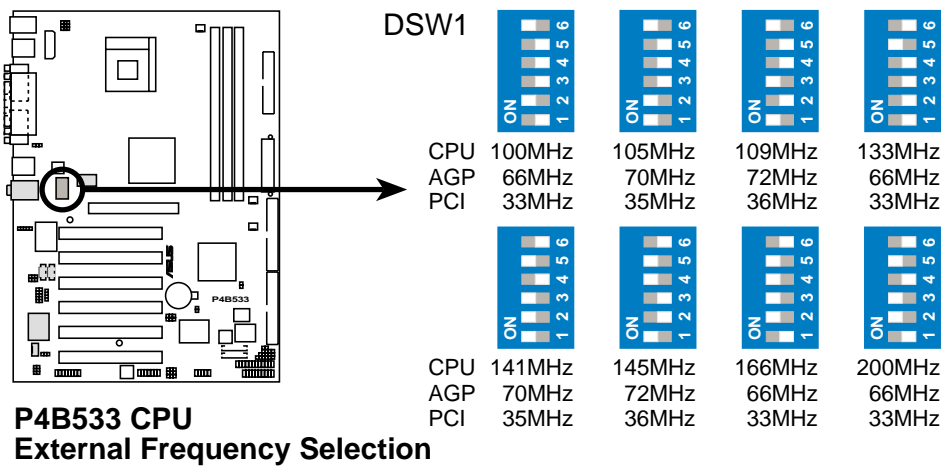

Set the CPU frequency only to the recommended settings. Frequencies other than the recommended CPU bus frequencies are not guaranteed to be stable.

#### 4. Keyboard power (3-pin KBPWR)

This jumper allows you to enable or disable the keyboard wake-up feature. Set this jumper to pins 2-3 (+5VSB) if you wish to wake up the computer when you press a key on the keyboard (the default is the Space Bar). This feature requires an ATX power supply that can supply at least 1A on the +5VSB lead, and a corresponding setting in the BIOS (see section 4.5.1 Power Up Control).

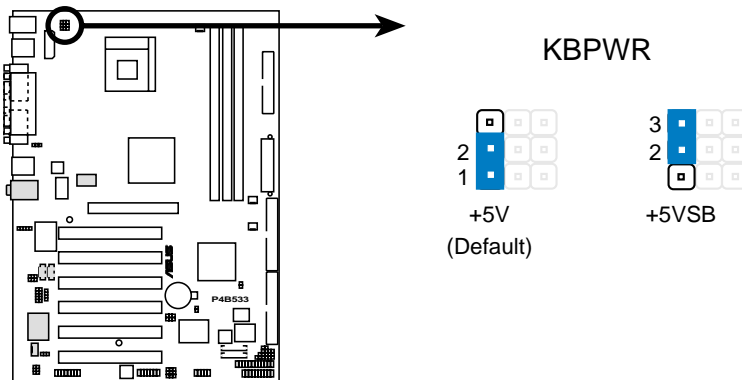

**P4B533 Keyboard Power Setting**

#### 5. Vcore over-voltage (3-pin OVER\_VOLT)

When enabled, this jumper allows CPU Vcore ranges of 1.5V to 1.95V for Pentium 4 Northwood CPU and 1.75V to 1.95V for Pentium 4 Willamette CPU.

When this jumper is disabled, Northwood has a Vcore setting range of +1.5V to +1.7V, and Willamette has 1.75V to 1.85V. You may adjust the CPU VCore through the BIOS Setup.



Setting to a very high core voltage may cause permanent damage to the CPU. It is recommended that you keep the default setting (Disable).

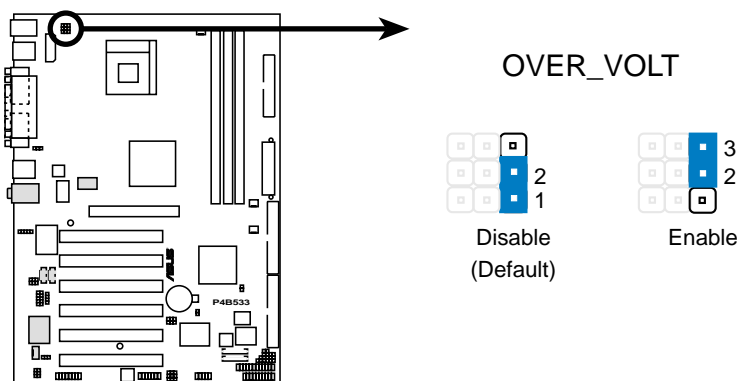

**P4B533 OVER\_VOLT Setting**

## 6. USB device wake-up (3-pin USBPWR\_12, USBPWR\_34, USBPWR\_56)

Set these jumpers to +5V to wake up the computer from S1 sleep mode (CPU stopped, DRAM refreshed, system running in low power mode) using the connected USB devices. Set to +5VSB to wake up from S3 sleep mode (no power to CPU, DRAM in slow refresh, power supply in reduced power mode). Both jumpers are set to pins 1-2 (+5V) by default because not all computers have the appropriate power supply to support this feature.

The USBPWR\_12 and USBPWR\_34 jumpers are for the rear USB ports. The USBPWR\_56 jumper is for the internal USB header that you can connect to the front USB ports.



1. This feature requires a power supply that can provide at least 1A on the +5VSB lead when these jumpers are set to +5VSB. Otherwise, the system does not power up.
2. The total current consumed must NOT exceed the power supply capability (+5VSB) whether under normal condition or in sleep mode.

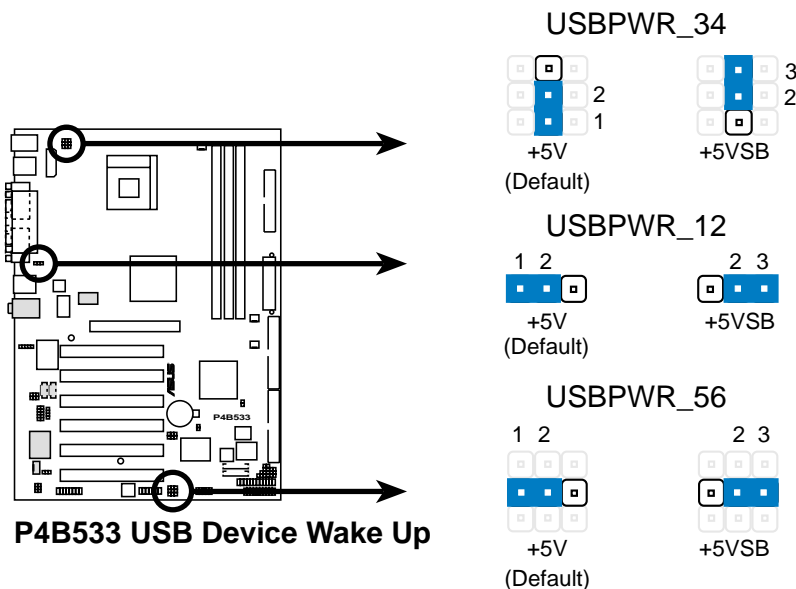

## 7. Speaker selector (3-pin SPEECH)

This jumper allows you to select the speaker you wish to use for the ASUS POST Reporter™ function. Set to pins 1-2 to use an external speaker. Connect the speakers to the Line Out jack (lime colored) on the rear panel. Set to pins 2-3 to use an internal speaker (usually built in the chassis).

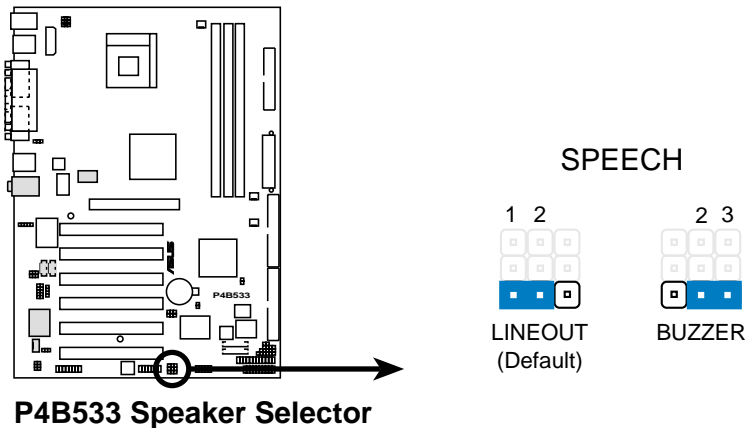

## 8. SMBus 2.0 setting (3-pin PCISMB\_SW1, PCISMB\_SW2)

These jumpers allow you to enable or disable the SMBus 2.0 support on the motherboard. When these jumpers are set to pins 2-3 (Enable), you may install PCI devices that comply with SMBus 2.0 specification.

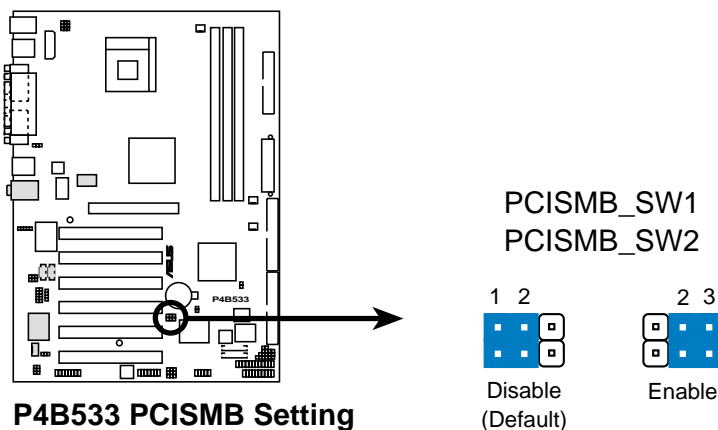



## 9. Line out selector (two 2-pin FP\_LO\_SWL, FP\_LO\_SWR) *(on audio models only)*

*(on audio models only)*

By default, these jumpers are shorted (jumper caps on) to route the signal from the audio controller to the rear panel Line Out jack to make it available for audio out devices such as speakers or a headphone.

If you connect the Intel Front Panel audio cable to the FP\_AUDIO connector (see page 2-33 for the location), remove the caps from these jumpers to allow automatic switching of audio signal between the rear panel Line Out jack and the audio cable.

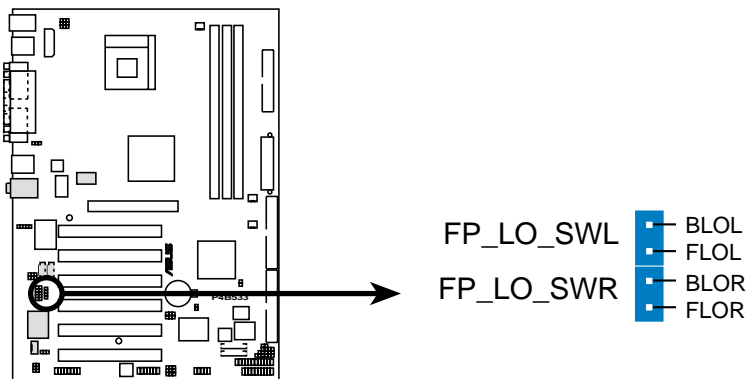

**P4B533 Internal Line Out Connectors**

## 10. Bass/Center setting (3-pin BCS1, BCS2) *(on audio models only)*

These jumpers allow you to select the speaker output for a 6-channel audio system. Switch the jumpers from the CENTER/BASS (pins 1-2) position to BASS/CENTER (pins 2-3) position to re-route signals on the internal leads of the Mic port.



Use the audio driver included in the support CD to install the multi-channel audio feature. See section “5.3 Software information.”

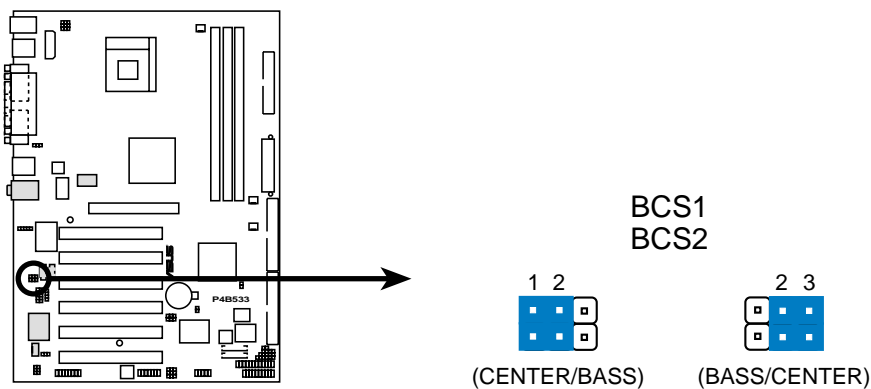

**P4B533 Bass Center Setting**

## 11. PCI audio setting (3-pin AUDIO\_SW) *(on audio models only)*

This jumper allows you to enable or disable the audio controller on the motherboard.



Disable the onboard audio controller if you desire to install a PCI audio card into a PCI slot.

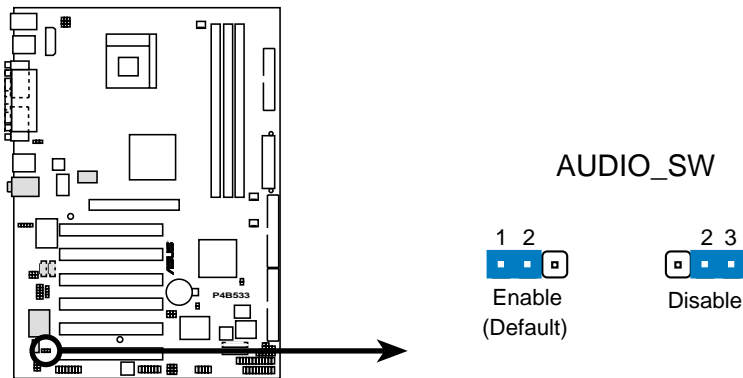

**P4B533 Audio Setting**

## 12. Clear RTC RAM (CLRTC)

This jumper allows you to clear the Real Time Clock (RTC) RAM in CMOS. You can clear the CMOS memory of date, time, and system setup parameters by erasing the CMOS RTC RAM data. The RAM data in CMOS, that include system setup information such as system passwords, is powered by the onboard button cell battery.

To erase the RTC RAM:

1. Turn OFF the computer and unplug the power cord.
2. Remove the battery.
3. Place a jumper cap over the CLRTC jumper for about 5 seconds, then remove the cap. **DON'T** leave the cap on the jumper!
4. Re-install the battery.
5. Plug the power cord and turn ON the computer.
6. Hold down the <Del> key during the boot process and enter BIOS setup to re-enter data.

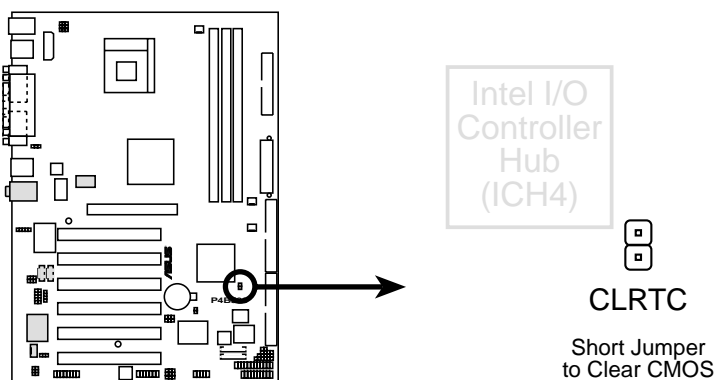

**P4B533 Clear RTC RAM**

## 2.8 Connectors

This section describes and illustrates the internal connectors on the motherboard.



Always connect ribbon cables with the red stripe to Pin 1 on the connectors. Pin 1 is usually on the side closest to the power connector on hard drives and CD-ROM drives, but may be on the opposite side on floppy disk drives.

### 1. Hard disk activity LED (2-pin IDE\_LED)

This connector supplies power to the hard disk activity LED. The read or write activities of any device connected to the primary or secondary IDE connector cause this LED to light up.

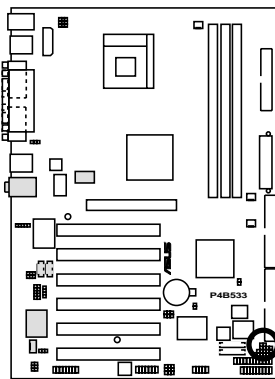

**TIP:** If the case-mounted LED does not light, try reversing the 2-pin plug.

IDE\_LED



**P4B533 HD Activity LED**

### 2. Floppy disk drive connector (34-1 pin FLOPPY)

This connector supports the provided floppy drive ribbon cable. After connecting one end to the motherboard, connect the other end to the floppy drive. (Pin 5 is removed to prevent incorrect insertion when using ribbon cables with pin 5 plug).

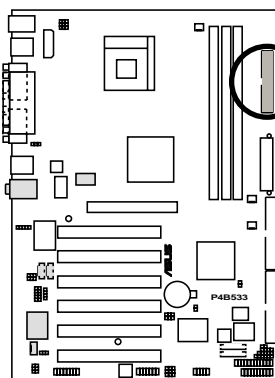

FLOPPY

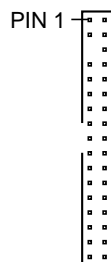

**NOTE:** Orient the red markings on the floppy ribbon cable to PIN 1.

**P4B533 Floppy Disk Drive Connector**

### 3. IDE connectors (40-1 pin PRI\_IDE, SEC\_IDE)

This connector supports the provided UltraDMA/100/66 IDE hard disk ribbon cable. Connect the cable's blue connector to the primary (recommended) or secondary IDE connector, then connect the gray connector to the UltraDMA/100/66 slave device (hard disk drive) and the black connector to the UltraDMA/100/66 master device. It is recommended that you connect non-UltraDMA/100/66 devices to the secondary IDE connector. If you install two hard disks, you must configure the second drive as a slave device by setting its jumper accordingly. Refer to the hard disk documentation for the jumper settings. BIOS supports specific device bootup. If you have more than two UltraDMA/100/66 devices, purchase another UltraDMA/100/66 cable. You may configure two hard disks to be both master devices with two ribbon cables – one for the primary IDE connector and another for the secondary IDE connector.



1. Pin 20 on each IDE connector is removed to match the covered hole on the UltraDMA cable connector. This prevents incorrect orientation when you connect the cables.
2. The hole near the blue connector on the UltraDMA/100/66 cable is intentional.

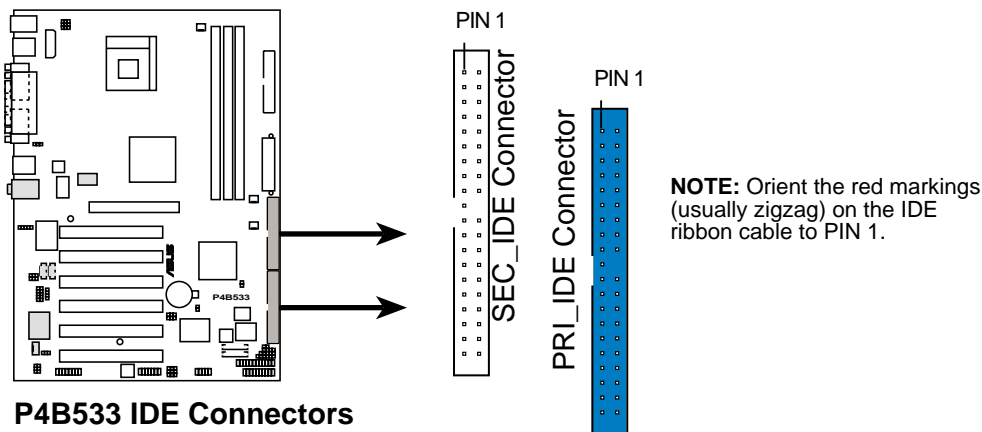

For UltraDMA/100/66 IDE devices, use an 80-conductor IDE cable. The UltraDMA/66 cable included in the motherboard package also supports UltraDMA/100.

#### 4. Chassis intrusion connector (4-1 pin CHASSIS)

This lead is for a chassis designed with intrusion detection feature. This requires an external detection mechanism such as a chassis intrusion sensor or microswitch. When you remove any chassis component, the sensor triggers and sends a high-level signal to this lead to record a chassis intrusion event.

By default, the pins labeled “Chassis Signal” and “Ground” are shorted with a jumper cap. If you wish to use the chassis intrusion detection feature, remove the jumper cap from the pins.

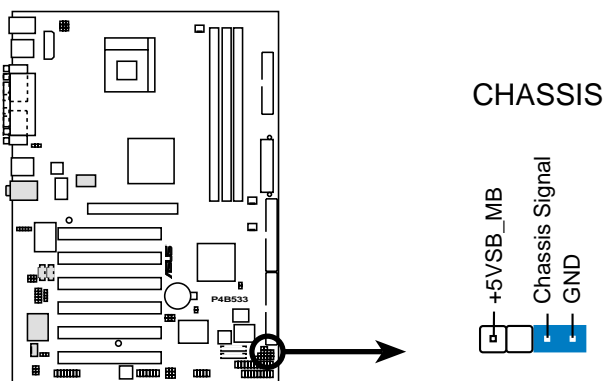

**P4B533 Chassis Intrusion Connector**

#### 5. SMBus connector (6-1 pin SMB)

This connector allows you to connect SMBus (System Management Bus) devices. Devices communicate with an SMBus host and/or other SMBus devices using the SMBus interface. SMBus is a specific implementation of an I<sup>2</sup>C bus, a multi-device bus that allows multiple chips to connect to the same bus and enable each one to act as a master by initiating data transfer.

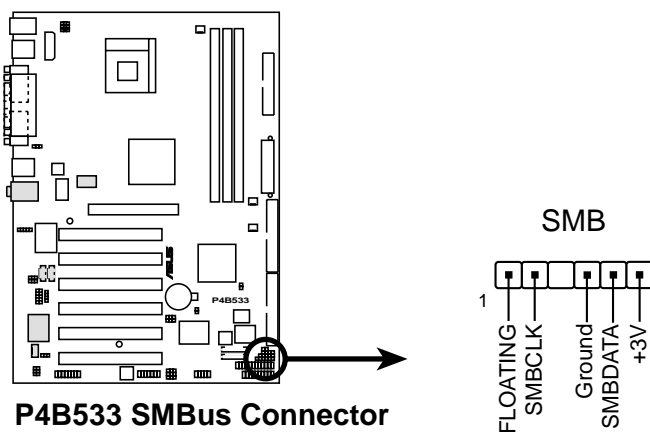

**P4B533 SMBus Connector**

## 6. ASUS EZ Plug™ and ATX power connectors (20-pin ATXPWR, 4-pin EZ\_PLUG, 4-pin ATX12V)

These connectors connect to an ATX 12V power supply. The plugs from the power supply are designed to fit these connectors in only one orientation. Find the proper orientation and push down firmly until the connectors completely fit.

In addition to the 20-pin ATXPWR connector, this motherboard requires that you connect the 4-pin ATX +12V power plug to provide sufficient power to the CPU.

If you are using a standard ATX power supply that does not have the ATX +12V plug, connect one 4-pin device power plug to the ASUS EZ Plug™ connector labeled EZ\_PLUG.



Make sure that your ATX 12V power supply can provide 8A on the +12V lead and at least 1A on the +5-volt standby lead (+5VSB). The minimum recommended wattage is 230W, or 300W for a fully configured system. The system may become unstable and may experience difficulty powering up if the power supply is inadequate.

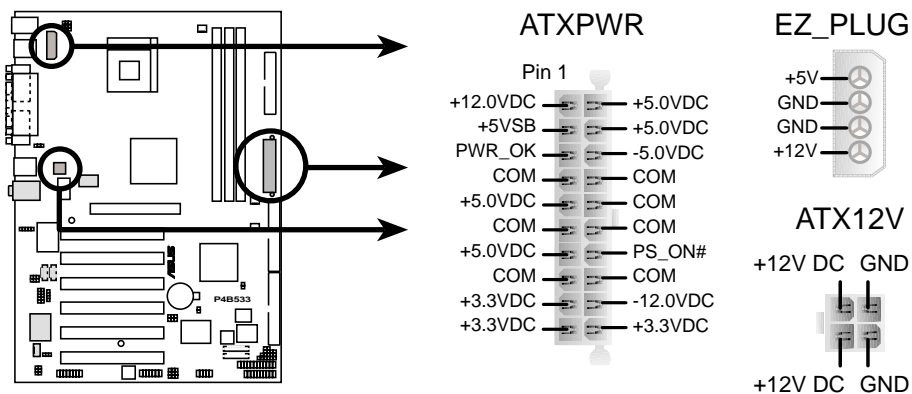

**P4B533 ATX & Auxiliary Power Connectors**

## 7. CPU, Chassis, and Power Fan Connectors (3-pin CPU\_FAN, PWR\_FAN, CHA\_FAN)

The fan connectors support cooling fans of 350mA~740mA (8.88W max.) or a total of 1A~2.22A (26.64W max.) at +12V. Connect the fan cables to the fan connectors on the motherboard, making sure that the black wire of each cable matches the ground pin of the connector.



Do not forget to connect the fan cables to the fan connectors. Lack of sufficient air flow within the system may damage the motherboard components. These are not jumpers! DO NOT place jumper caps on the fan connectors!

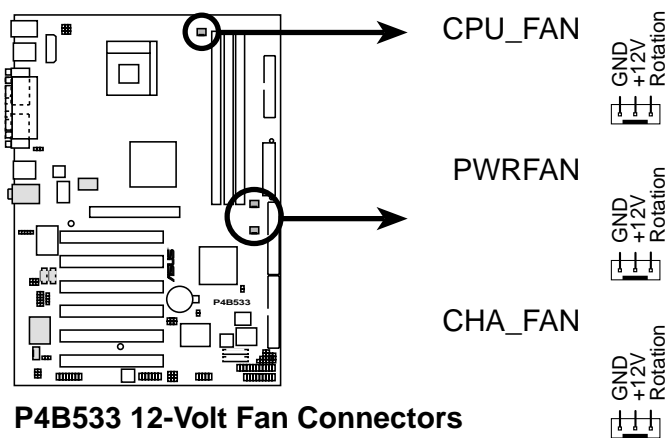

## 8. Power supply thermal connector (2-pin TRPWR)

If your power supply has a thermal monitoring feature, connect its thermal sensor cable to this connector.

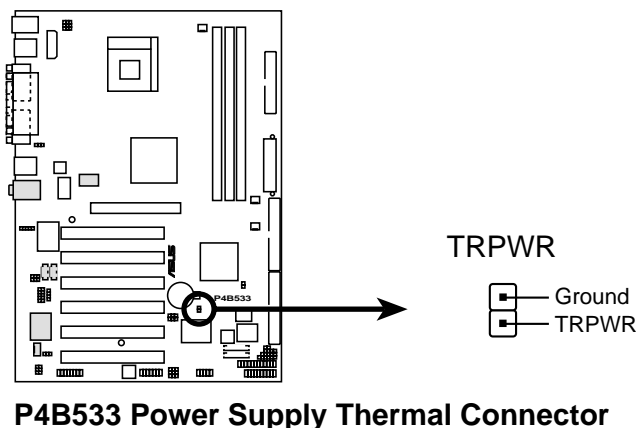



## 9. USB header (10-1 pin USB20\_56)

If the USB ports on the rear panel are inadequate, a USB header is available for additional USB ports. The USB header complies with USB 2.0 specification that supports up to 480 Mbps connection speed. This speed advantage over the conventional 12 Mbps on USB 1.1 allows faster Internet connection, interactive gaming, and simultaneous running of high-speed peripherals.

If your package came with a USB 2.0/GAME module, connect the USB cable to this header. The module has two USB 2.0 ports that support the next generation USB peripherals such as high resolution cameras, scanners, and printers.



Download the USB 2.0 driver from the Microsoft website ([www.microsoft.com](http://www.microsoft.com)). You must install the driver before you can use the USB 2.0 capability.

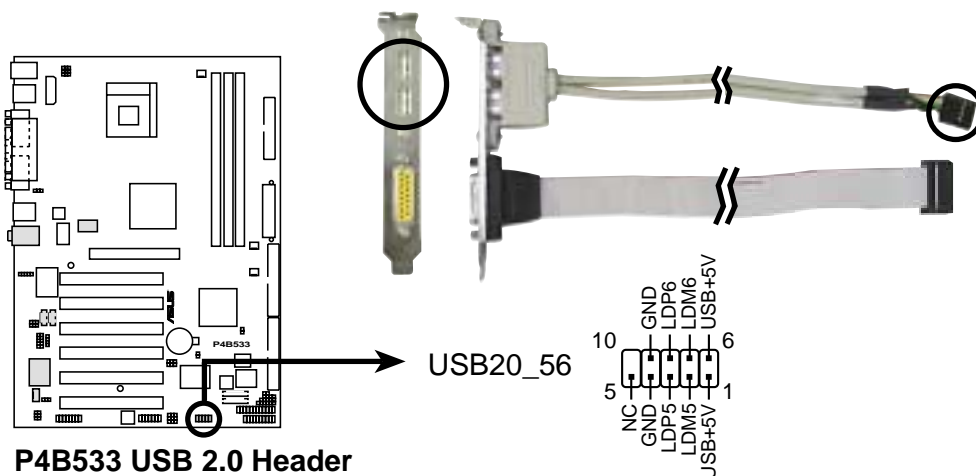

## 10. Smart Card Reader connector (14-1 pin SMARTCON) (optional)

This connector accommodates a Smart Card Reader that allows you to conveniently make transactions such as financial, health care, telephony, or traveling services through a Smart Card user interface software.

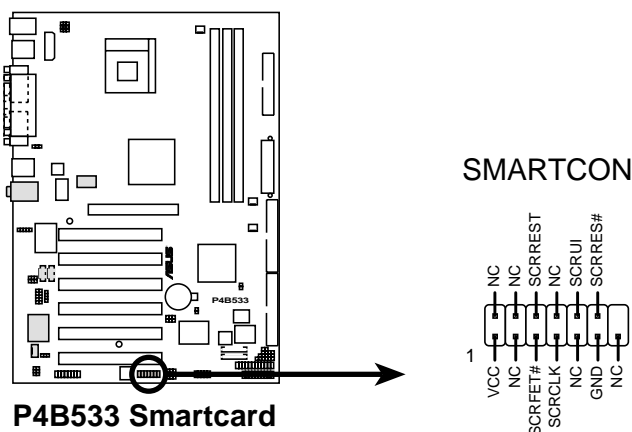

## 11. Infrared module connector (5-pin IR)

This connector supports an optional wireless transmitting and receiving infrared module. This module mounts to a small opening on system chassis that support this feature. You must also configure the **UART2 Use As** parameter in BIOS to set UART2 for use with IR. See section “4.4.2 I/O Device Configuration” for details.

Use the five pins as shown in Back View and connect a ribbon cable from the module to the motherboard SIR connector according to the pin definitions.

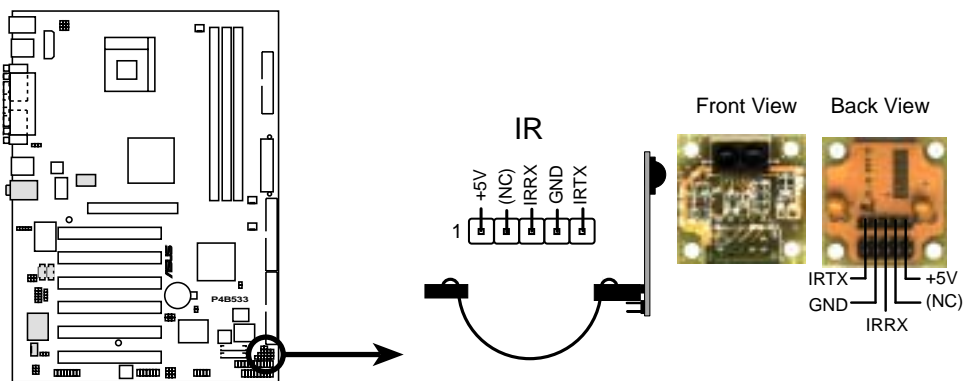

**P4B533 Infrared Module Connector**

## 12. GAME/MIDI connector (16-1 pin GAME)

This connector supports a GAME/MIDI module. If your package came with the optional USB 2.0/GAME module, connect the GAME/MIDI cable to this connector. The GAME/MIDI port on the module connects a joystick or a game pad for playing games, and MIDI devices for playing or editing audio files.

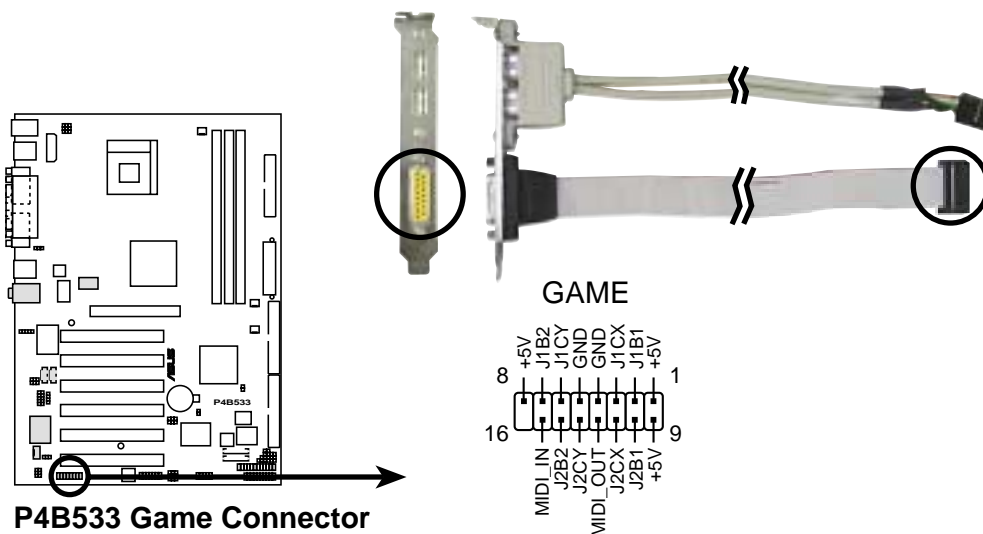

**P4B533 Game Connector**

### 13. Internal audio connectors (4-pin CD1, AUX, MODEM)

*(on audio models only)*

These connectors allow you to receive stereo audio input from sound sources such as a CD-ROM, TV tuner, or MPEG card. The MODEM connector allows the onboard audio to interface with a voice modem card with a similar connector. It also allows the sharing of mono\_in (such as a phone) and a mono\_out (such as a speaker) between the audio and a voice modem card.

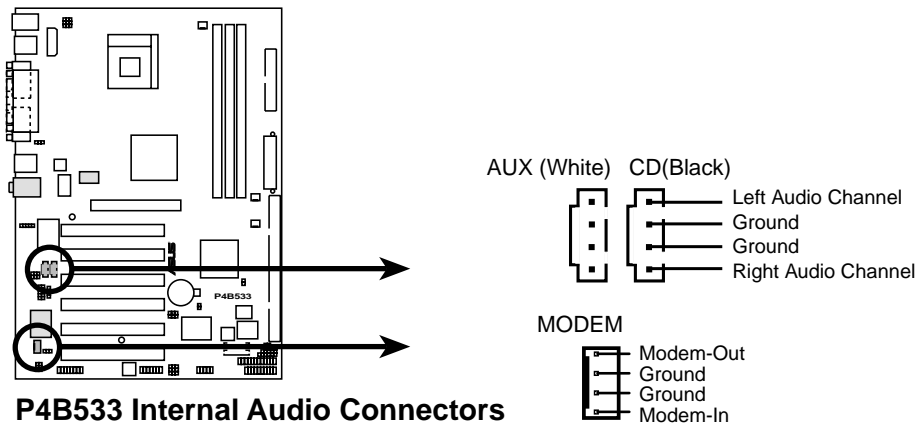

### 14. Line in connector (5-pin FP\_LINE\_IN) *(on audio models only)*

This connector is for a front panel Line In jack with a return path for automatic signal switching. By default, pins 1-2 and pins 4-5 are shorted with jumper caps to make the Line In source available from the rear panel Line In jack. Remove the jumper caps if you desire to install the Intel front panel audio cable.

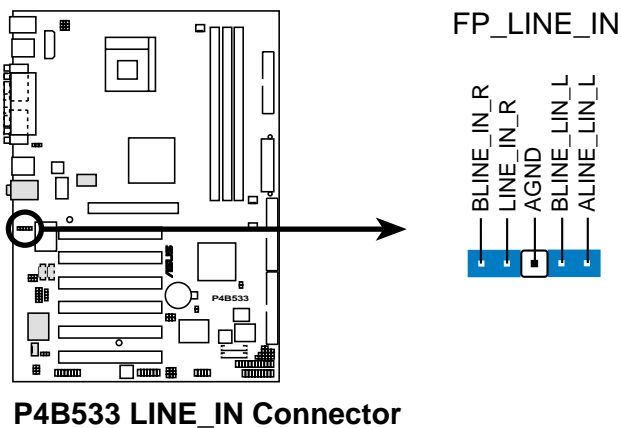



## 17. Front panel audio connector (10-1 pin FP\_AUDIO)

*(on audio models only)*

This is an interface for the Intel front panel audio cable that allow convenient connection and control of audio devices.



Make sure to remove the caps from the FP\_LO\_SWL and FP\_LO\_SWR jumpers if you installed the Intel front panel audio cable. Refer to page 2-22 for the location of the jumpers.

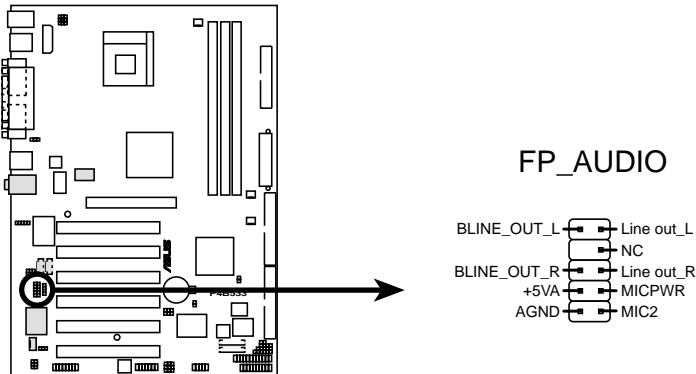

**P4B533 Front Panel Audio Connector**

## 18. System panel connector (20-pin PANEL)

This connector accommodates several system front panel functions.

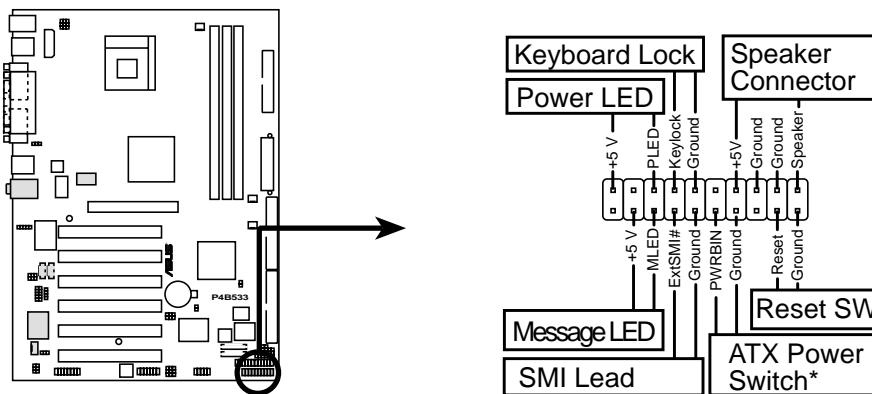

**P4B533 System Panel Connectors** \* Requires an ATX power supply.

- **System Power LED Lead (3-1 pin PLED)**

This 3-1 pin connector connects to the system power LED. The LED lights up when you turn on the system power, and blinks when the system is in sleep mode.
- **Keyboard Lock Lead (2-pin KEYLOCK)**

This 2-pin connector connects to a chassis-mounted switch to allow the use of the keyboard lock feature.
- **System Warning Speaker Lead (4-pin SPEAKER)**

This 4-pin connector connects to the case-mounted speaker and allows you to hear system beeps and warnings.
- **System Message LED Lead (2-pin MLED)**

This 2-pin connector is for the system message LED that indicates receipt of messages from a fax/modem. The normal status for this LED is OFF, when there is no incoming data signal. The LED blinks when data is received. The system message LED feature requires an ACPI OS and driver support.
- **System Management Interrupt Lead (2-pin SMI)**

This 2-pin connector allows you to manually place the system into a suspend mode, or “green” mode, where system activity is instantly decreased to save power and to expand the life of certain system components. Attach the case-mounted suspend switch to this 2-pin connector.
- **ATX Power Switch / Soft-Off Switch Lead (2-pin PWRBTN)**

This connector connects a switch that controls the system power. Pressing the power switch turns the system between ON and SLEEP, or ON and SOFT OFF, depending on the BIOS or OS settings. Pressing the power switch while in the ON mode for more than 4 seconds turns the system OFF.
- **Reset Switch Lead (2-pin RESET)**

This 2-pin connector connects to the case-mounted reset switch for rebooting the system without turning off the system power.



# ***Chapter 3***

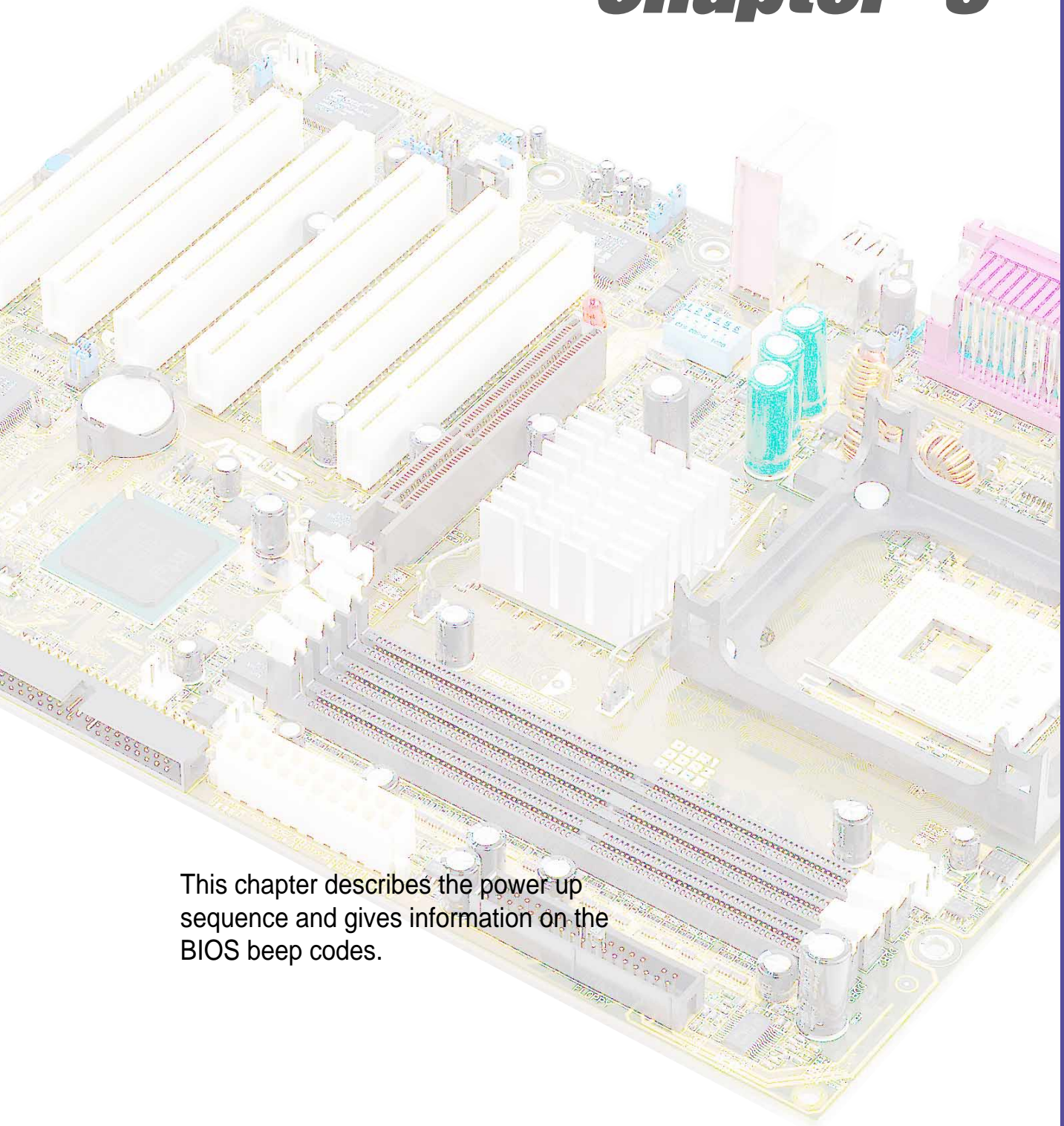

This chapter describes the power up sequence and gives information on the BIOS beep codes.

## **Powering up**



## **Chapter summary**

- 3.1 Starting up for the first time ..... 3-1**
- 3.2 Vocal POST Messages ..... 3-2**
- 3.3 Powering off the computer ..... 3-4**

## 3.1 Starting up for the first time

1. After making all the connections, replace the system case cover.
2. Be sure that all switches are off.
3. Connect the power cord to the power connector at the back of the system chassis.
  4. Connect the power cord to a power outlet that is equipped with a surge protector.
5. Turn on the devices in the following order:
  - a. Monitor
  - b. External SCSI devices (starting with the last device on the chain)
  - c. System power (if you are using an ATX power supply, you need to switch on the power supply as well as press the ATX power switch on the front of the chassis).
6. After applying power, the power LED on the system front panel case lights up. For ATX power supplies, the system LED lights up when you press the ATX power switch. If your monitor complies with “green” standards or if it has a “power standby” feature, the monitor LED may light up or switch between orange and green after the system LED turns on. The system then runs the power-on tests. While the tests are running, the BIOS beeps or additional messages appear on the screen. If you do not see anything within 30 seconds from the time you turned on the power, the system may have failed a power-on test. Check the jumper settings and connections or call your retailer for assistance.

### Award BIOS Beep Codes

Beep	Meaning
One short beep when displaying logo	No error during POST
Long beeps in an endless loop	No DRAM installed or detected
One long beep followed by three short beeps	Video card not found or video card memory bad
High frequency beeps when system is working	CPU overheated; System running at a lower frequency



You will not hear the BIOS beeps when the ASUS POST Reporter™ is enabled. You will hear the vocal POST messages instead.

7. At power on, hold down <Delete> to enter BIOS Setup. Follow the instructions in Chapter 4.

## 3.2 Vocal POST Messages

This motherboard includes the Winbond speech controller to support a special feature called the ASUS POST Reporter™. This feature gives you vocal POST messages and alerts to inform you of system events and boot status. In case of a boot failure, you will hear the specific cause of the problem.

These POST messages are customizable using the Winbond Voice Editor software that came with your package. You can record your own messages to replace the default messages.

Following is a list of the default POST messages and their corresponding actions, if any.

POST Message	Action
No CPU installed	<ul style="list-style-type: none"><li>• Install an Intel Pentium 4 Processor into the CPU socket.</li></ul>
System failed CPU test	<ul style="list-style-type: none"><li>• Check the CPU if properly installed.</li><li>• Call ASUS technical support for assistance. See the “ASUS contact information” on page x.</li></ul>
System failed memory test	<ul style="list-style-type: none"><li>• Install 184-pin unbuffered PC2100/1600 DIMMs into the DIMM sockets.</li><li>• Check if the DIMMs on the DIMM sockets are properly installed.</li><li>• Make sure that your DIMMs are not defective.</li><li>• Refer to section “2.5 System memory” for instruction on installing a DIMM.</li></ul>
System failed VGA test	<ul style="list-style-type: none"><li>• Install a PCI VGA card into one of the PCI slots, or a 1.5V AGP card into the AGP slot.</li><li>• Make sure that your VGA/AGP card is not defective.</li></ul>
System failed due to CPU over-clocking	<ul style="list-style-type: none"><li>• In JumperFree mode, check your CPU settings in BIOS and make sure you only set to the recommended settings. See section “4.4 Advanced menu.”</li><li>• In jumper mode, refer to section “2.7 Switches and jumpers.”</li></ul>

POST Message	Action
No keyboard detected	<ul style="list-style-type: none"> <li>• Check your keyboard if properly connected to the purple PS/2 connector on the rear panel.</li> <li>• See section “1.4.1 Major components” for the location of the connector.</li> </ul>
No floppy disk detected	<ul style="list-style-type: none"> <li>• Make sure you have connected a floppy disk to the floppy disk connector on the motherboard.</li> <li>• See section “2.8 Connectors.”</li> </ul>
No IDE hard disk detected	<ul style="list-style-type: none"> <li>• Make sure you have connected an IDE hard disk drive to the one of the IDE connectors on the motherboard.</li> <li>• See section “2.8 Connectors.”</li> </ul>
CPU temperature too high	<ul style="list-style-type: none"> <li>• Check CPU fan if working properly.</li> </ul>
CPU fan failed	<ul style="list-style-type: none"> <li>• Check the CPU fan and make sure it turns on after you applied power to the system.</li> </ul>
CPU voltage out of range	<ul style="list-style-type: none"> <li>• Check your power supply and make sure it is not defective.</li> <li>• Call ASUS technical support for assistance. See the “ASUS contact information” on page x.</li> </ul>
System completed Power-On Self Test	<ul style="list-style-type: none"> <li>• No action required</li> </ul>
Computer now booting from operating system	<ul style="list-style-type: none"> <li>• No action required</li> </ul>



You may disable the ASUS POST Reporter™ in the BIOS setup. See section “4.4.2 I/O Device Configuration”.

## 3.3 Powering off the computer

You must first exit the operating system and shut down the system before switching off the power. For ATX power supplies, you can press the ATX power switch after exiting or shutting down the operating system. If you use Windows 95/98/2000/XP, click the Start button, click Shut Down, then click the OK button to shut down the computer. The power supply should turn off after Windows shuts down.



---

The message “You can now safely turn off your computer” does not appear when shutting down with ATX power supplies.

---

# *Chapter 4*

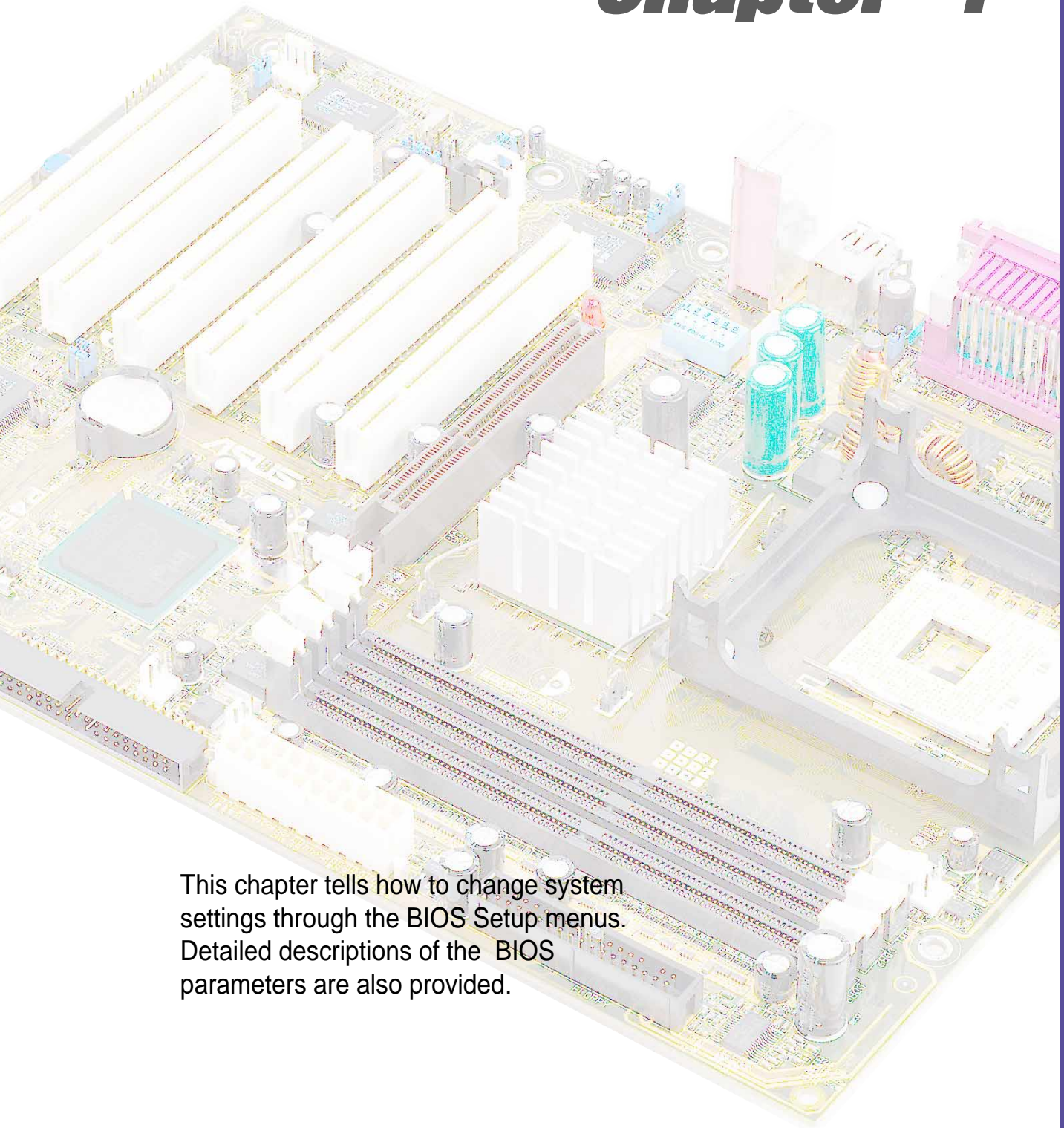

This chapter tells how to change system settings through the BIOS Setup menus. Detailed descriptions of the BIOS parameters are also provided.

## **BIOS setup**

## **Chapter summary**

<b>4.1</b>	<b>Managing and updating your BIOS .....</b>	<b>4-1</b>
<b>4.2</b>	<b>BIOS Setup program .....</b>	<b>4-7</b>
<b>4.3</b>	<b>Main Menu .....</b>	<b>4-10</b>
<b>4.4</b>	<b>Advanced Menu .....</b>	<b>4-17</b>
<b>4.5</b>	<b>Power Menu .....</b>	<b>4-28</b>
<b>4.6</b>	<b>Boot Menu .....</b>	<b>4-34</b>
<b>4.7</b>	<b>Exit Menu .....</b>	<b>4-36</b>



## 4.1 Managing and updating your BIOS



---

It is recommended that you save a copy of the motherboard's **original BIOS** to a bootable floppy disk in case you need to reinstall the original BIOS later.

---

### 4.1.1 Using ASUS EZ Flash to update the BIOS

The ASUS EZ Flash feature allows you to easily update the BIOS without having to go through the long process of booting from a diskette and using a DOS-based utility. The EZ Flash is built-in the BIOS firmware so it is accessible by simply pressing <Alt> + <F2> during the Power-On Self Tests (POST).

Follow these steps to update the BIOS using ASUS EZ Flash.

1. Download the latest BIOS file from the ASUS website (see ASUS contact information on page x). Save the file to a floppy disk.



---

Write down the BIOS file name on a piece of paper. You need to type the **exact BIOS file name** at the EZ Flash screen.

---

2. Reboot the computer.
3. To use EZ Flash, press <Alt> + <F2> during POST to display the following screen.

```
ASUS EZ Flash V1.00
Copyright (C) 2002, ASUSTeK COMPUTER INC.

[Onboard BIOS Information]
BIOS Version      : ASUS P4B533 ACPI BIOS Revision 1002
BIOS Model       : P4B533
BIOS Built Date  : 04/16/02

Please Enter File Name for NEW BIOS: _
*Note: EZ Flash will copy file from A:\, Press [ESC] to reboot
```



---

The BIOS information in the above screen is for reference only. What you see on your screen may not be exactly the same as shown.

---

4. Insert the disk that contains the new BIOS file into the floppy drive. You will receive the error message, “**WARNING! Device not ready.**” if you proceed to step 5 without the disk in the drive.

5. At the prompt, “**Please Enter File Name for NEW BIOS: \_**”, type in the BIOS file name that you downloaded from the ASUS website, then press <Enter>.

EZ Flash will automatically access drive A to look for the file name that you typed. When found, the following message appears on screen.

```
[BIOS Information in File]
BIOS Version:  P4B533 Boot Block

WARNING! Continue to update the BIOS (Y/N)? _
```

If you accidentally typed in a wrong BIOS file name, the error message, “**WARNING! File not found.**” appears. Press <Enter> to remove the message, then type in the correct file name. Press <Enter>.

6. At the above prompt, type **Y** to continue with the update process. Pressing **N** exits the EZ Flash screen and reboots the system without updating the BIOS.

The following prompts appear if you typed **Y**.

```
Flash Memory:  SST 49LF004

1. Update Main BIOS area      (Y/N)? _
2. Update Boot Block area    (Y/N)? _
```

7. Press **Y** for both items to completely update the main BIOS area and the boot block area.



---

DO NOT shutdown or reset the system while updating the BIOS boot block area! Doing so may cause system boot failure.

---

8. When the update process is done, the message, “**Press a key to reboot**” appears. Press any key to reboot the system with the new BIOS.

## 4.1.2 Using AFLASH to update the BIOS

### Creating a bootable disk

AFLASH.EXE is a Flash Memory Writer utility that updates the BIOS by uploading a new BIOS file to the programmable flash ROM on the motherboard. This file works only in DOS mode. To determine the BIOS version of your motherboard, check the last four numbers of the code displayed on the upper left-hand corner of your screen during bootup. Larger numbers represent a newer BIOS file.

1. Type `FORMAT A:/S` at the DOS prompt to create a bootable system disk. DO NOT copy `AUTOEXEC.BAT` and `CONFIG.SYS` to the disk.
2. Type `COPY D:\AFLASH\AFLASH.EXE A:\` (assuming D is your CD-ROM drive) to copy `AFLASH.EXE` to the boot disk you created.



---

AFLASH works only in DOS mode. It does not work in the DOS prompt within Windows, and does not work with certain memory drivers that may be loaded when you boot from the hard drive. It is recommended that you reboot using a floppy disk.

---

3. Reboot the computer from the floppy disk.



---

BIOS setup must specify “Floppy” as the first item in the boot sequence.

---

4. In DOS mode, type `A:\AFLASH <Enter>` to run AFLASH.

```
ASUS ACPI BIOS
FLASH MEMORY WRITER U2.0
Copyright (C) 1994-2001 ASUSTeK COMPUTER INC.

Flash Memory: Winbond W29C020 or SST Z9EE020 or Intel 82802AB

Current BIOS Version: ASUS XXX-XX ACPI BIOS Revision 100X
BIOS Model          : XXX-XX
BIOS Built Date     : 12/25/01

Choose one of the followings:

1. Save Current BIOS To File
2. Update BIOS Including Boot Block and ESCD

Enter choice: [1]

Press ESC To Exit
```



---

If the word “unknown” appears after Flash Memory:, the memory chip is either not programmable or is not supported by the ACPI BIOS and therefore, cannot be programmed by the Flash Memory Writer utility.

---

5. Select 1. Save Current BIOS to File from the Main menu and press <Enter>. The Save Current BIOS To File screen appears.

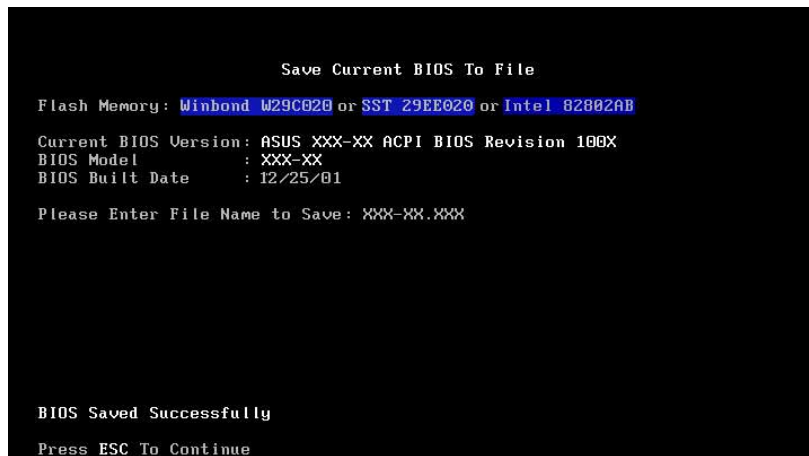

6. Type a filename and the path, for example, A:\XXX-XX.XXX, then press <Enter>.

## Updating the BIOS



Update the BIOS only if you have problems with the motherboard and you are sure that the new BIOS revision will solve your problems. Careless updating may result to more problems with the motherboard!

1. Download an updated ASUS BIOS file from the Internet (WWW or FTP) (see ASUS CONTACT INFORMATION on page x for details) and save to the boot floppy disk you created earlier.
2. Boot from the floppy disk.
3. At the "A:" prompt, type AFLASH and then press <Enter>.
4. At the Main Menu, type 2 then press <Enter>. The Update BIOS Including Boot Block and ESCD screen appears.
5. Type the filename of your new BIOS and the path, for example, A:\XXX-XX.XXX, then press <Enter>.

To cancel this operation, press <Enter>.

```
Update BIOS Including Boot Block and ESCD
Flash Memory: Winbond W29C020 or SST 29EE020 or Intel 82802AB
Current BIOS Version: ASUS XXX-XX ACPI BIOS Revision 100X
BIOS Model      : XXX-XX
BIOS Built Date   : 12/25/01
Please Enter File Name for NEW BIOS: A:\XXX-XX.XXX
```

6. When prompted to confirm the BIOS update, press Y to start the update.

```
Update BIOS Including Boot Block and ESCD
Flash Memory: Winbond W29C020 or SST 29EE020 or Intel 82802AB
BIOS Version
[CURRENT ] ASUS XXX-XX ACPI BIOS Revision 100X
[test.awd] ASUS XXX-XX ACPI BIOS Revision 100X
BIOS Model
[CURRENT ] XXX-XX
[test.awd] XXX-XX
Date of BIOS Built
[CURRENT ] 09/25/99
[XXXX.XXX] 05/29/00
Check sum of 1001.010 is F266.
Are you sure (Y/N) ? [Y]
Press ESC To Return to Main Menu
```

7. The utility starts to program the new BIOS information into the Flash ROM. The boot block is updated automatically only when necessary. This minimizes the possibility of boot problems in case of update failures. When the programming is done, the message “*Flashed Successfully*” appears.

```
Update BIOS Including Boot Block and ESCD

Flash Memory: Winbond W29C020 or SST 29EE020 or Intel 82802AB

BIOS Version
[CURRENT] ASUS XXX-XX ACPI BIOS Revision 100X
[test.awd] ASUS XXX-XX ACPI BIOS Revision 100X

BIOS Model
[CURRENT] XXX-XX
[test.awd] XXX-XX

Date of BIOS Built
[CURRENT] 12/25/01
[XXXX.XXX] 05/29/00

Check sum of 1001.010 is F266.

Are you sure (Y/N) ? [Y]
Block Erasing -- Done
Programming -- 3FFFF
Flashed Successfully

Press ESC To Continue
```

8. Follow the onscreen instructions to continue.

```
ASUS ACPI BIOS
FLASH MEMORY WRITER V2.0
Copyright (C) 1994-2001 ASUSTeK COMPUTER INC.

Flash Memory: Winbond W29C020 or SST 29EE020 or Intel 82802AB

Current BIOS Version: ASUS XXX-XX ACPI BIOS Revision 100X
BIOS Model : XXX-XX
BIOS Built Date : 12/25/01

Choose one of the followings:

1. Save Current BIOS To File
2. Update BIOS Including Boot Block and ESCD

Enter choice: [1]

You have flashed the EPROM:It is recommended that you turn off
the power, enter SETUP and LOAD Setup Defaults to have CMOS
updated with new BIOS when exits.

Press ESC To Exit
```



If you encounter problems while updating the new BIOS, DO NOT turn off the system because this may cause boot problems. Just repeat the process, and if the problem persists, load the original BIOS file you saved to the boot disk. If the Flash Memory Writer utility is not able to successfully update a complete BIOS file, the system may not boot. If this happens, call the ASUS service center for support.

## 4.2 BIOS Setup program

This motherboard supports a programmable Flash ROM that you can update using the provided utility described in section “4.1 Managing and updating your BIOS.”

Use the BIOS Setup program when you are installing a motherboard, reconfiguring your system, or prompted to “Run Setup”. This section explains how to configure your system using this utility.

Even if you are not prompted to use the Setup program, you may want to change the configuration of your computer in the future. For example, you may want to enable the security password feature or make changes to the power management settings. This requires you to reconfigure your system using the BIOS Setup program so that the computer can recognize these changes and record them in the CMOS RAM of the Flash ROM.

The Flash ROM on the motherboard stores the Setup utility. When you start up the computer, the system provides you with the opportunity to run this program. Press <Delete> during the Power-On Self Test (POST) to enter the Setup utility, otherwise, POST continues with its test routines.

If you wish to enter Setup after POST, restart the system by pressing <Ctrl> + <Alt> + <Delete>, or by pressing the reset button on the system chassis. You can also restart by turning the system off and then back on. Do this last option only if the first two failed.

The Setup program is designed to make it as easy to use as possible. It is a menu-driven program, which means you can scroll through the various sub-menus and make your selections among the predetermined choices.



---

Because the BIOS software is constantly being updated, the following BIOS setup screens and descriptions are for reference purposes only, and may not exactly match what you see on your screen.

---

## 4.2.1 BIOS menu bar

The top of the screen has a menu bar with the following selections:

<b>MAIN</b>	Use this menu to make changes to the basic system configuration.
<b>ADVANCED</b>	Use this menu to enable and make changes to the advanced features.
<b>POWER</b>	Use this menu to configure and enable Power Management features.
<b>BOOT</b>	Use this menu to configure the default system device used to locate and load the Operating System.
<b>EXIT</b>	Use this menu to exit the current menu or to exit the Setup program.

To access the menu bar items, press the right or left arrow key on the keyboard until the desired item is highlighted.

## 4.2.2 Legend bar

At the bottom of the Setup screen is a legend bar. The keys in the legend bar allow you to navigate through the various setup menus. The following table lists the keys found in the legend bar with their corresponding functions.

<b>Navigation Key(s)</b>	<b>Function Description</b>
<b>&lt;F1&gt; or &lt;Alt + H&gt;</b>	Displays the General Help screen from anywhere in the BIOS Setup
<b>&lt;Esc&gt;</b>	Jumps to the Exit menu or returns to the main menu from a sub-menu
<b>Left or Right arrow</b>	Selects the menu item to the left or right
<b>Up or Down arrow</b>	Moves the highlight up or down between fields
<b>- (minus key)</b>	Scrolls backward through the values for the highlighted field
<b>+ (plus key) or spacebar</b>	Scrolls forward through the values for the highlighted field
<b>&lt;Enter&gt;</b>	Brings up a selection menu for the highlighted field
<b>&lt;Home&gt; or &lt;PgUp&gt;</b>	Moves the cursor to the first field
<b>&lt;End&gt; or &lt;PgDn&gt;</b>	Moves the cursor to the last field
<b>&lt;F5&gt;</b>	Resets the current screen to its Setup Defaults
<b>&lt;F10&gt;</b>	Saves changes and exits Setup



## General help

In addition to the Item Specific Help window, the BIOS setup program also provides a General Help screen. You may launch this screen from any menu by simply pressing <F1> or the <Alt> + <H> combination. The General Help screen lists the legend keys and their corresponding functions.

## Saving changes and exiting the Setup program

See “4.7 Exit Menu” for detailed information on saving changes and exiting the setup program.

## Scroll bar

When a scroll bar appears to the right of a help window, it indicates that there is more information to be displayed that will not fit in the window. Use <PgUp> and <PgDn> or the up and down arrow keys to scroll through the entire help document. Press <Home> to display the first page, press <End> to go to the last page. To exit the help window, press <Enter> or <Esc>.

## Sub-menu

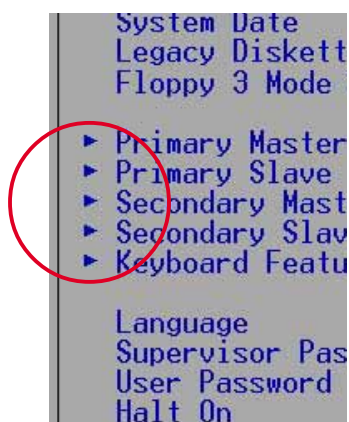

Note that a right pointer symbol (as shown on the left) appears to the left of certain fields. This pointer indicates that you can display a sub-menu from this field. A sub-menu contains additional options for a field parameter. To display a sub-menu, move the highlight to the field and press <Enter>. The sub-menu appears. Use the legend keys to enter values and move from field to field within a sub-menu as you would within a menu. Use the <Esc> key to return to the main menu.

Take some time to familiarize yourself with the legend keys and their corresponding functions. Practice navigating through the various menus and sub-menus. If you accidentally make unwanted changes to any of the fields, use the set default hot key <F5> to load the Setup default values. While moving around through the Setup program, note that explanations appear in the Item Specific Help window located to the right of each menu. This window displays the help text for the currently highlighted field.

## 4.3 Main Menu

When you enter the Setup program, the following screen appears.

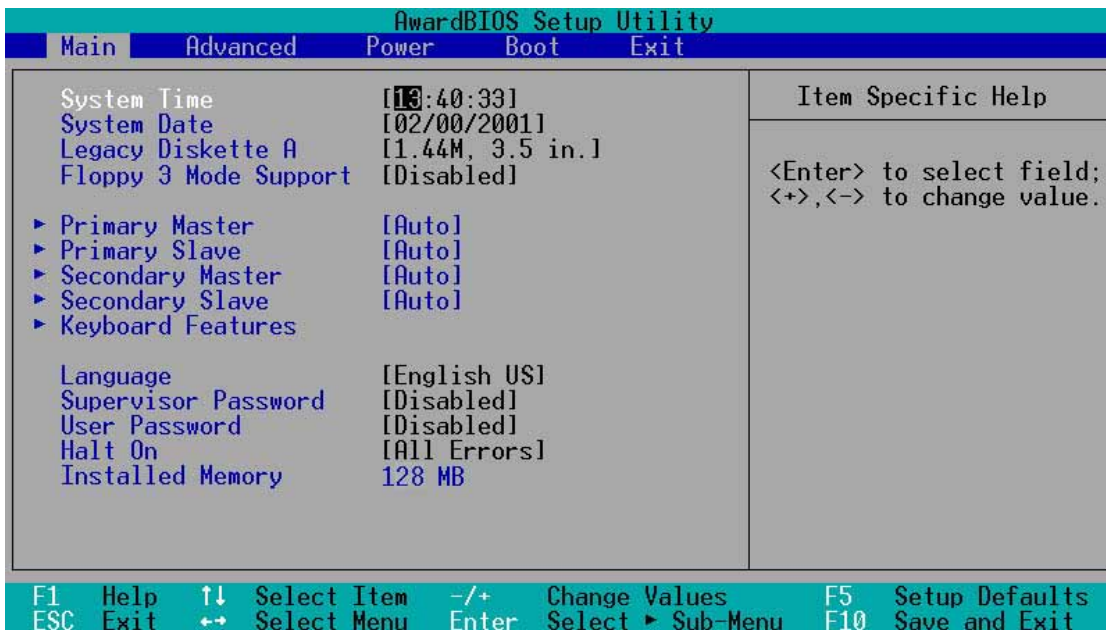

### System Time [XX:XX:XX]

Sets the system to the time that you specify (usually the current time). The format is hour, minute, second. Valid values for hour, minute and second are Hour: (00 to 23), Minute: (00 to 59), Second: (00 to 59). Use the <Tab> or <Shift> + <Tab> keys to move between the hour, minute, and second fields.

### System Date [XX/XX/XXXX]

Sets the system to the date that you specify (usually the current date). The format is month, day, year. Valid values for month, day, and year are Month: (1 to 12), Day: (1 to 31), Year: (up to 2099). Use the <Tab> or <Shift> + <Tab> keys to move between the month, day, and year fields.

### Legacy Diskette A [1.44M, 3.5 in.]

Sets the type of floppy drive installed. Configuration options: [None] [360K, 5.25 in.] [1.2M , 5.25 in.] [720K , 3.5 in.] [1.44M, 3.5 in.] [2.88M, 3.5 in.]

### Floppy 3 Mode Support [Disabled]

This is required to support older Japanese floppy drives. The Floppy 3 Mode feature allows reading and writing of 1.2MB (as opposed to 1.44MB) on a 3.5-inch diskette. Configuration options: [Disabled] [Enabled]

## **Language [English US]**

This field allows you to choose the BIOS language version from the available options.

## **Supervisor Password [Disabled] / User Password [Disabled]**

These fields allow you to set passwords. To set a password, highlight the appropriate field and press <Enter>. Type in a password then press <Enter>. You can type up to eight alphanumeric characters. Symbols and other characters are ignored. To confirm the password, type the password again and press <Enter>. The password is now set to [Enabled]. This password allows full access to the BIOS Setup menus. To clear the password, highlight this field and press <Enter>. The same dialog box as above appears. Press <Enter>. The password is set to [Disabled].

### **A note about passwords**

The BIOS Setup program allows you to specify passwords in the Main menu. The passwords control access to the BIOS during system startup. Passwords are not case sensitive, meaning, passwords typed in either uppercase or lowercase letters are accepted. The BIOS Setup program allows you to specify two different passwords: a Supervisor password and a User password. If you did not set a Supervisor password, anyone can access the BIOS Setup program. If you did, the Supervisor password is required to enter the BIOS Setup program and to gain full access to the configuration fields.

### **Forgot the password?**

If you forget your password, you can clear it by erasing the CMOS Real Time Clock (RTC) RAM. The RAM data containing the password information is powered by the onboard button cell battery. See section “2.7 Switches and jumpers” for information on how to erase the RTC RAM.

## **Halt On [All Errors]**

This field specifies the types of errors that will cause the system to halt. Configuration options: [All Errors] [No Error] [All but Keyboard] [All but Disk] [All but Disk/Keyboard]

## **Installed Memory [XXX MB]**

This field automatically displays the amount of conventional memory detected by the system during the boot process.

## 4.3.1 Primary and Secondary Master/Slave

AwardBIOS Setup Utility			
Main			
Primary Master [Auto]		Item Specific Help	
Type	[Auto]	<p>&lt;Enter&gt; to select the type of the IDE drive. [User Type HDD] allows you to set each entry on your own.</p> <p>WARNING: Ultra DMA mode 3/4/5 can be enabled only when BIOS detects shielded 80-pin cable.</p>	
Cylinders	[ 1024]		
Head	[255]		
Sector	[63]		
CHS Capacity	8422MB		
Maximum LBA Capacity	25590MB		
Multi-Sector Transfers	[Maximum]		
SMART Monitoring	[Disabled]		
PIO Mode	[4]		
ULTRA DMA Mode	[Disabled]		
F1 Help	↑↓ Select Item	-/+ Change Values	F5 Setup Defaults
ESC Exit	↔ Select Menu	Enter Select ► Sub-Menu	F10 Save and Exit

### Type [Auto]

Select [Auto] to automatically detect an IDE hard disk drive. If automatic detection is successful, Setup automatically fills in the correct values for the remaining fields on this sub-menu. If automatic detection fails, this may be because the hard disk drive is too old or too new. If the hard disk was already formatted on an older system, Setup may detect incorrect parameters. In these cases, select [User Type HDD] to manually enter the IDE hard disk drive parameters. Refer to the next section for details.



Before attempting to configure a hard disk drive, make sure you have the correct configuration information supplied by the drive manufacturer. Incorrect settings may cause the system to fail to recognize the installed hard disk.

## [User Type HDD]

AwardBIOS Setup Utility			
Main			
Primary Master	[User Type HDD]	Item Specific Help	
Type	[User Type HDD]	<p>&lt;Enter&gt; to select the type of the IDE drive. [User Type HDD] allows you to set each entry on your own.</p> <p>WARNING: Ultra DMA mode 3/4/5 can be enabled only when BIOS detects shielded 80-pin cable.</p>	
Translation Method	[LBA]		
Cylinders	[ 1024]		
Head	[255]		
Sector	[63]		
CHS Capacity	8422MB		
Maximum LBA Capacity	25590MB		
Multi-Sector Transfers	[Maximum]		
SMART Monitoring	[Disabled]		
PIO Mode	[4]		
ULTRA DMA Mode	[Disabled]		
F1 Help	↑↓ Select Item		-/+ Change Values
ESC Exit	↔ Select Menu		Enter Select ▶ Sub-Menu
		F5 Setup Defaults	
		F10 Save and Exit	

Manually enter the number of cylinders, heads and sectors per track for the drive. Refer to the drive documentation or on the drive label for this information.



After entering the IDE hard disk drive information into BIOS, use a disk utility, such as FDISK, to partition and format new IDE hard disk drives. This is necessary so that you can write or read data from the hard disk. Make sure to set the partition of the Primary IDE hard disk drives to active.

If no drive is installed or if you are removing a drive and not replacing it, select [None].

Other options for the Type field are:

**[CD-ROM]** - for IDE CD-ROM drives

**[LS-120]** - for LS-120 compatible floppy disk drives

**[ZIP]** - for ZIP-compatible disk drives

**[MO]** - for IDE magneto optical disk drives

**[Other ATAPI Device]** - for IDE devices not listed here

After making your selections on this sub-menu, press the <Esc> key to return to the Main menu. When the Main menu appears, the hard disk drive field displays the size for the hard disk drive that you configured.

## **Translation Method [LBA]**

Select the hard disk drive type in this field. When Logical Block Addressing (LBA) is enabled, the 28-bit addressing of the hard drive is used without regard for cylinders, heads, or sectors. Note that LBA Mode is necessary for drives with more than 504MB storage capacity. Configuration options: [LBA] [LARGE] [Normal] [Match Partition Table] [Manual]

## **Cylinders**

This field configures the number of cylinders. Refer to the drive documentation to determine the correct value. To make changes to this field, set the Type field to [User Type HDD] and the Translation Method field to [Manual].

## **Head**

This field configures the number of read/write heads. Refer to the drive documentation to determine the correct value. To make changes to this field, set the Type field to [User Type HDD] and the Translation Method field to [Manual].

## **Sector**

This field configures the number of sectors per track. Refer to the drive documentation to determine the correct value. To make changes to this field, set the Type field to [User Type HDD] and the Translation Method field to [Manual].

## **CHS Capacity**

This field shows the drive's maximum CHS capacity as calculated by the BIOS based on the drive information you entered.

## **Maximum LBA Capacity**

This field shows the drive's maximum LBA capacity as calculated by the BIOS based on the drive information you entered.

### **Multi-Sector Transfers [Maximum]**

This option automatically sets the number of sectors per block to the highest number that the drive supports. Note that when this field is automatically configured, the set value may not always be the fastest value for the drive. You may also manually configure this field. Refer to the documentation that came with the hard drive to determine the optimum value and set it manually. To make changes to this field, set the Type field to [User Type HDD]. Configuration options: [Disabled] [2 Sectors] [4 Sectors] [8 Sectors] [16 Sectors] [32 Sectors] [Maximum]

### **SMART Monitoring [Disabled]**

This field allows you to enable or disable the S.M.A.R.T. (Self-Monitoring, Analysis and Reporting Technology) system that utilizes internal hard disk drive monitoring technology. This parameter is normally disabled because the resources used in the SMART monitoring feature may decrease system performance. Configuration options: [Disabled] [Enabled]

### **PIO Mode [4]**

This option lets you set a PIO (Programmed Input/Output) mode for the IDE device. Modes 0 through 4 provide successive increase in performance. Configuration options: [0] [1] [2] [3] [4]

### **Ultra DMA Mode [Disabled]**

Ultra DMA capability allows improved transfer speeds and data integrity for compatible IDE devices. Set to [Disabled] to suppress Ultra DMA capability. To make changes to this field, set the Type field to [User Type HDD]. Configuration options: [0] [1] [2] [3] [4] [5] [Disabled]



## 4.3.2 Keyboard Features

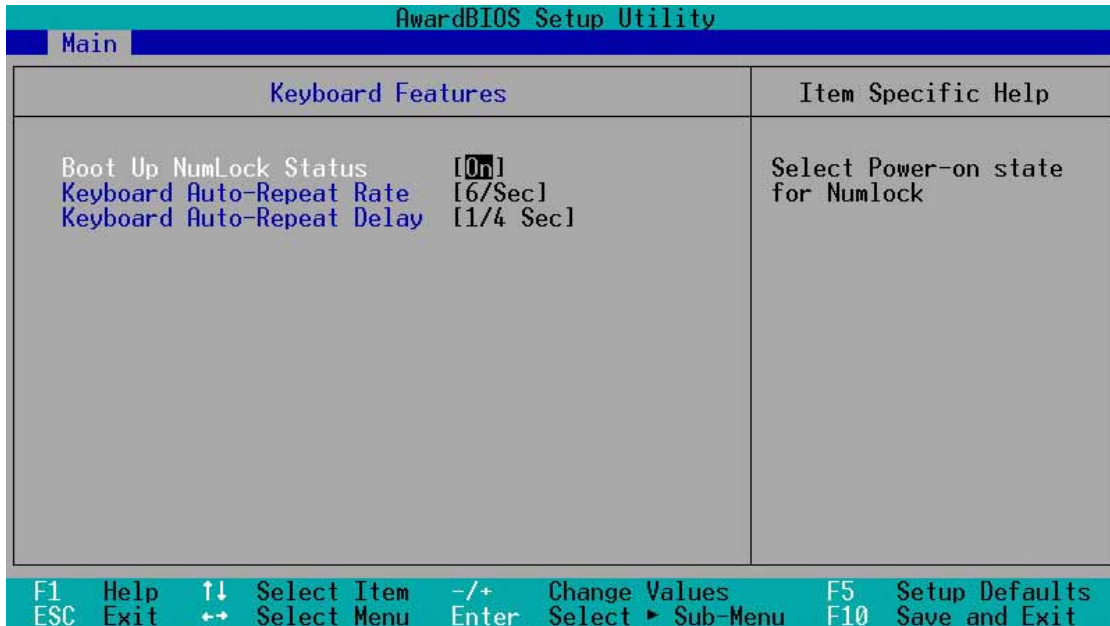

### Boot Up NumLock Status [On]

This field enables users to activate the Number Lock function upon system boot. Configuration options: [Off] [On]

### Keyboard Auto-Repeat Rate [6/Sec]

This controls the speed at which the system registers repeated keystrokes. Options range from 6 to 30 characters per second. Configuration options: [6/Sec] [8/Sec] [10/Sec] [12/Sec] [15/Sec] [20/Sec] [24/Sec] [30/Sec]

### Keyboard Auto-Repeat Delay [1/4 Sec]

This field sets the time interval for displaying the first and second characters. Configuration options: [1/4 Sec] [1/2 Sec] [3/4 Sec] [1 Sec]



## 4.4 Advanced Menu

AwardBIOS Setup Utility			
Main	Advanced	Power	Boot Exit
CPU Speed	[ Manual ]		<b>Item Specific Help</b>  To make changes to the first 4 fields, the motherboard must be set to jumperfree mode.  To set the following 2 fields, the CPU speed must be set to [Manual]. If the frequency multiple or bus frequency are adjusted too high, the system may hang. Please turn off the system and then restart to set the CPU settings.
CPU Frequency Multiple	[13x]		
CPU External Frequency (MHz)	[100]		
CPU/Memory Frequency Ratio	[Auto]		
AGP/PCI Frequency Setting	[Auto]		
CPU Vcore Setting	[Auto]		
CPU Vcore	[1.750V]		
DDR Reference Voltage	[2.6V]		
AGP VDDQ Voltage	[1.5V]		
CPU Level 1 Cache	[Enabled]		
CPU Level 2 Cache	[Enabled]		
BIOS Update	[Enabled]		
PS/2 Mouse Function Control	[Auto]		
USB Legacy Support	[Auto]		
OS/2 Onboard Memory > 64M	[Disabled]		
▶ Chip Configuration			
▶ I/O Device Configuration			
▶ PCI Configuration			
F1 Help	↑↓ Select Item	-/+ Change Values	F5 Setup Defaults
ESC Exit	↔ Select Menu	Enter Select ▶ Sub-Menu	F10 Save and Exit

### CPU Speed [Manual]

When the motherboard is set to JumperFree™ mode, this field allows you to select the internal frequency of the CPU. Select [Manual] if you want to make changes to the two subsequent fields. Note that selecting a frequency higher than the CPU manufacturer recommends may cause the system to hang or crash.

### CPU Frequency Multiple (when CPU Speed is set to [Manual])

This field is for unlocked processors only. If your processor frequency multiple is locked, you cannot access this field. This field sets the frequency multiple between the CPU's internal frequency (CPU speed) and external frequency. Set this field in conjunction with CPU Frequency (MHz) to match the speed of the CPU.

### CPU External Frequency (MHz) (when CPU Speed is set to [Manual])

This feature tells the clock generator what frequency to send to the system bus and PCI bus. The bus frequency (external frequency) multiplied by the bus multiple equals the CPU speed.

## CPU/Memory Frequency Ratio [Auto]

This field determines whether the memory clock frequency is set to be in synchronous or asynchronous mode with respect to the system frequency. The options that appear in the popup menu vary according to the CPU Frequency (MHz). Configuration options: [Auto] [1:1] [3:4]

## AGP/PCI Frequency Setting [Auto]

When set to [Auto], this field allows automatic selection of AGP/PCI frequency to enhance system performance and overclocking capability. The setting [Manual] allows you to manually select the AGP/PCI frequency. If the system becomes unstable, return to the default setting [Auto]. When this item is set to [Manual], the **AGP/PCI Frequency (MHz)** item appears. Configuration options: [Auto] [Manual]

AwardBIOS Setup Utility				
Main	Advanced	Power	Boot	Exit
CPU Speed			[ Manual ]	Item Specific Help
CPU Frequency Multiple			[13x]	
CPU External Frequency (MHz)			[100]	
CPU/Memory Frequency Ratio			[Auto]	
AGP/PCI Frequency Setting			[Manual]	
AGP/PCI Frequency (MHz)			[66.66/33.33]	To make changes to the first 4 fields, the motherboard must be set to jumper-free mode.
CPU VCore Setting			[Auto]	

## AGP/PCI Frequency (MHz) [66.66/33.33]

This item appears only when the **AGP/PCI Frequency Setting** is set to [Manual]. This field allows you to select a higher AGP/PCI frequency for better system performance.



Selecting a very high AGP/PCI frequency may cause the system to be unstable!

## CPU VCore Setting [Auto]

The [Manual] setting allows you to manually select the core voltage supplied to the CPU (see next item). However, it is recommended that you keep the default setting [Auto] to allow the system to automatically determine the appropriate CPU core voltage.

## **CPU VCore [1.750V] (for Willamette), [1.500V] (for Northwood)**

When the CPU VCore Setting parameter above is set to [Manual], the CPU VCore item allows you to select a specific CPU core voltage. This field is not accessible when the CPU VCore Setting is set to [Auto].

Depending on the OVER\_VOLT jumper setting (see page 2-19 for the jumper location and settings), the CPU core voltage options vary for both Willamette and Northwood processors. See the following table.



Refer to the CPU documentation before setting this field. A very high core voltage may severely damage the CPU!

<b>OVER_VOLT Jumper</b> <b>P4 Processor</b>	<b>Disabled</b>	<b>Enabled</b>
<b>Willamette</b>	1.750V, 1.775V, 1.800V, 1.825V, 1.850V	1.750V, 1.775V, 1.800V, 1.825V, 1.850V, 1.875V, 1.900V, 1.925V, 1.950V
<b>Northwood</b>	1.500V, 1.525V, 1.550V, 1.575V, 1.600V, 1.625V, 1.650V, 1.675V, 1.700V	1.500V, 1.525V, 1.550V, 1.575V, 1.600V, 1.625V, 1.650V, 1.675V, 1.700V, 1.725V, 1.750V, 1.775V, 1.800V, 1.825V, 1.850V, 1.875V, 1.900V, 1.925V, 1.950V

## **DDR Reference Voltage [2.6V]**

This item controls the DDR SDRAM operating voltage. Configuration options: [2.9V] [2.7V] [2.6V]

## **AGP VDDQ Voltage [1.5V]**

This item controls the AGP operating voltage. Configuration options: [1.7V] [1.6V] [1.5]

## **CPU Level 1 Cache, CPU Level 2 Cache [Enabled]**

These fields allow you to choose from the default [Enabled] or choose [Disabled] to turn on or off the CPU Level 1 and Level 2 built-in cache. Configuration options: [Disabled] [Enabled]

### **BIOS Update [Enabled]**

This field functions as an update loader integrated into the BIOS to supply the processor with the required data. When set to [Enabled], the BIOS loads the update on all processors during system bootup. Configuration options: [Disabled] [Enabled]

### **PS/2 Mouse Function Control [Auto]**

The default setting [Auto] allows the system to detect a PS/2 mouse at startup. If a mouse is detected, the BIOS assigns IRQ12 to the PS/2 mouse. Otherwise, IRQ12 can be used for expansion cards. When you set this field to [Enabled], BIOS reserves IRQ12, whether or not a PS/2 mouse is detected at startup. Configuration options: [Enabled] [Auto]

### **USB Legacy Support [Auto]**

This motherboard supports Universal Serial Bus (USB) devices. The default of [Auto] allows the system to detect a USB device at startup. If detected, the USB controller legacy mode is enabled. If not detected, the USB controller legacy mode is disabled.

When you set this field to [Disabled], the USB controller legacy mode is disabled whether or not you are using a USB device. Configuration options: [Disabled] [Enabled] [Auto]

### **OS/2 Onboard Memory > 64M [Disabled]**

When using OS/2 operating systems with installed DRAM of greater than 64MB, you need to set this option to [Enabled]. Otherwise, leave to the default setting [Disabled]. Configuration options: [Disabled] [Enabled]

## 4.4.1 Chip Configuration

AwardBIOS Setup Utility		
Advanced		
Chip Configuration		Item Specific Help
SDRAM Configuration	[By SPD]	<Enter> to select SDRAM configuration. [By SPD] is recommended. [User Defined] allows you to set each configuration on your own.
SDRAM CAS Latency	[2.5T]	
SDRAM RAS to CAS Delay	[3T]	
SDRAM RAS Precharge Delay	[3T]	
SDRAM Active Precharge Delay	[6T]	
SDRAM Idle Timer	[Infinite]	
CKx16 Strength Control	[2.00x]	
CKx8 Strength Control	[2.00x]	
DQ DQS Strength Control	[2.00x]	
Graphics Aperture Size	[ 64MB]	
AGP Capability	[4X Mode]	
Video Memory Cache Mode	[UC]	
Memory Hole At 15M-16M	[Disabled]	
Delay Transaction	[Disabled]	
Onboard PCI IDE	[Both]	
USB 2.0 HS Reference Voltage	[Medium]	

F1 Help ↑↓ Select Item -/+ Change Values F5 Setup Defaults  
ESC Exit ↔ Select Menu Enter Select ► Sub-Menu F10 Save and Exit

### SDRAM Configuration [By SPD]

This parameter allows you to set the optimal timings for items 2–5, depending on the memory modules that you are using. The default setting is [By SPD], which configures items 2–5 by reading the contents in the SPD (Serial Presence Detect) device. The EEPROM on the memory module stores critical information about the module, such as memory type, size, speed, voltage interface, and module banks.

Configuration options: [User Defined] [By SPD]



The SDRAM parameters (items 2~5) become configurable only when you set the SDRAM Configuration to [User Defined].

### SDRAM CAS Latency [2.5T]

This item controls the latency between the SDRAM read command and the time the data actually becomes available. It is recommended to keep the default setting for stable system operation.

### SDRAM RAS to CAS Delay [3T]

This item controls the latency between the DDR SDRAM active command and the read/write command. It is recommended to keep the default setting for stable system operation.

### **SDRAM RAS Precharge Delay [3T]**

This item controls the idle clocks after issuing a precharge command to the DDR SDRAM. It is recommended to keep the default setting for stable system operation.

### **SDRAM Active Precharge Delay [6T]**

This item controls the number of DDR SDRAM clocks used for DDR SDRAM parameters. It is recommended to keep the default setting for stable system operation.

### **SDRAM Idle Timer [Infinite]**

Configuration options: [Infinite] [0T] [8T] [16T] [64T]

### **CKx16 Strength Control [2.00x]**

This item controls the drive strength of the DDR SDRAM clock signal for an x16 device. It is recommended to keep the default setting for stable system operation. Configuration options: [0.75x] [1.00x] [1.25x] [1.50x] [1.75x] [2.00x] [2.25x] [2.50x] [2.75x] [3.00x] [3.25x] [3.50] [3.75x] [4.00x]

### **CKx8 Strength Control [2.00x]**

This item controls the drive strength of the DDR SDRAM clock signal for an x8 device. It is recommended to keep the default setting for stable system operation. Configuration options: [0.75x] [1.00x] [1.25x] [1.50x] [1.75x] [2.00x] [2.25x] [2.50x] [2.75x] [3.00x] [3.25x] [3.50] [3.75x] [4.00x]

### **DQ DQS Strength Control [2.00x]**

This item controls the drive strength of the DDR SDRAM signals DQ and DQS. It is recommended to keep the default setting for stable system operation. Configuration options: [0.75x] [1.00x] [1.25x] [1.50x] [1.75x] [2.00x] [2.25x] [2.50x] [2.75x] [3.00x] [3.25x] [3.50] [3.75x] [4.00x]

### **Graphics Aperture Size [64MB]**

This feature allows you to select the size of mapped memory for AGP graphic data. Configuration options: [4MB] [8MB] [16MB] [32MB] [64MB] [128MB] [256MB]

### **AGP Capability [4X Mode]**

This motherboard supports the AGP 4X interface that transfers video data at 1066MB/s. AGP 4X is backward-compatible, so you may keep the default [4X Mode] even if you are using an AGP 1X video card. When set to [1X Mode], the AGP interface only provides a peak data throughput of 266MB/s even if you are using an AGP 4x card.

Configuration options: [1X Mode] [4X Mode]

### **Video Memory Cache Mode [UC]**

USWC (uncacheable, speculative write combining) is a new cache technology for the video memory of the processor. It can greatly improve the display speed by caching the display data. You must set this to UC (uncacheable) if your display card does not support this feature, otherwise the system may not boot. Configuration options: [UC] [USWC]

### **Memory Hole At 15M-16M [Disabled]**

This field allows you to reserve an address space for ISA expansion cards. Setting the address space to a particular setting makes that memory space unavailable to other system components. Expansion cards can only access memory up to 16MB. Configuration options: [Disabled] [Enabled]

### **Delayed Transaction [Disabled]**

When set to [Enabled], this feature frees the PCI bus when the CPU is accessing 8-bit ISA cards. This process normally consumes about 50-60 PCI clocks without PCI delayed transaction. Set this field to [Disabled] when using ISA cards that are not PCI 2.1 compliant. Configuration options: [Enabled] [Disabled]

### **Onboard PCI IDE [Both]**

This field allows you to enable either the primary IDE channel or secondary IDE channel, or both. You can also set both channels to [Disabled]. Configuration options: [Both] [Primary] [Secondary] [Disabled]

### **USB 2.0 HS Reference Voltage [Medium]**

This item controls the USB 2.0 high-speed drive strength reference voltage. Configuration options: [Low] [Medium] [High] [Maximum]



## 4.4.2 I/O Device Configuration

AwardBIOS Setup Utility		
Advanced		
I/O Device Configuration		Item Specific Help
Floppy Disk Access Control	[R/W]	<Enter> to select.
Onboard Serial Port 1	[3F8H/IRQ4]	
Onboard Serial Port 2	[2F8H/IRQ3]	
UART2 Use As	[COM Port]	
Onboard Parallel Port	[378H/IRQ7]	
Parallel Port Mode	[ECP+EPP]	
ECP DMA Select	[3]	
Speech POST Reporter	[Enabled]	
F1 Help    ↑↓ Select Item    -/+ Change Values    F5 Setup Defaults ESC Exit    ↔ Select Menu    Enter Select ► Sub-Menu    F10 Save and Exit		

### Floppy Disk Access Control [R/W]

When set to [Read Only], this parameter protects files from being copied to floppy disks by allowing reads from, but not writes to, the floppy disk drive. The default setting [R/W] allows both reads and writes. Configuration options: [R/W] [Read Only]

### Onboard Serial Port 1 [3F8H/IRQ4]

### Onboard Serial Port 2 [2F8H/IRQ3]

These fields allow you to set the addresses for the onboard serial connectors. Serial Port 1 and Serial Port 2 must have different addresses. Configuration options: [3F8H/IRQ4] [2F8H/IRQ3] [3E8H/IRQ4] [2E8H/IRQ10] [Disabled]

### UART2 Use As [COM Port]

This field allows you to select the device on which to assign UART2. Configuration options: [COM Port] [IR] [Smart Card Reader]

### Onboard Parallel Port [378H/IRQ7]

This field allows you to set the address of the onboard parallel port connector. If you disable this field, the Parallel Port Mode and ECP DMA Select configurations are not available. Configuration options: [Disabled] [378H/IRQ7] [278H/IRQ5]



### **Parallel Port Mode [ECP+EPP]**

This field allows you to set the operation mode of the parallel port. [Normal] allows normal-speed operation but in one direction only; [EPP] allows bidirectional parallel port operation; [ECP] allows the parallel port to operate in bidirectional DMA mode; [ECP+EPP] allows normal speed operation in a two-way mode. Configuration options: [Normal] [EPP] [ECP] [ECP+EPP]

### **ECP DMA Select [3]**

This field allows you to configure the parallel port DMA channel for the selected ECP mode. This selection is available only if you select [ECP] or [ECP+EPP] in Parallel Port Mode above. Configuration options: [1] [3]

### **Speech POST Reporter [Enabled]**

This field enables or disables the ASUS POST Reporter™ feature. See section “1.3 Special Features” and “3.2 Vocal POST messages” for more information. Configuration options: [Disabled] [Enabled]

## 4.4.3 PCI Configuration

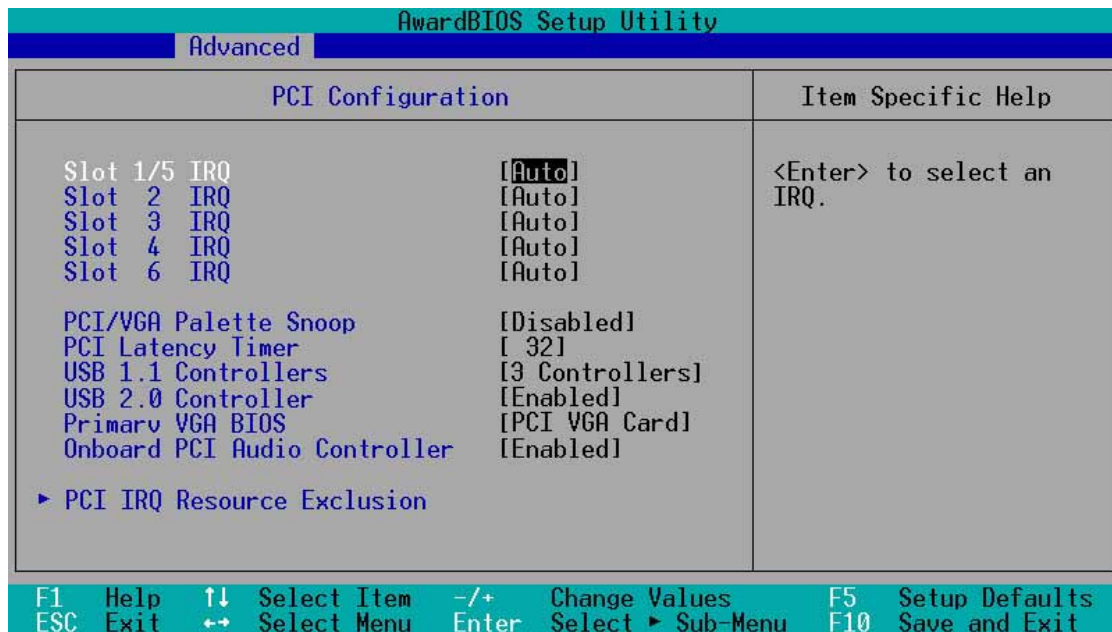

### Slot 1/5, Slot 2, Slot 3, Slot 4, Slot 6 IRQ [Auto]

These fields automatically assign the IRQ for each PCI slot. The default setting for each field is [Auto], which utilizes auto-routing to determine IRQ assignments. Configuration options: [Auto] [NA] [3] [4] [5] [7] [9] [10] [11] [12] [14] [15]

### PCI/VGA Palette Snoop [Disabled]

Some non-standard VGA cards, like graphics accelerators or MPEG video cards, may not show colors properly. Setting this field to [Enabled] corrects this problem. If you are using standard VGA cards, leave this field to the default setting [Disabled]. Configuration options: [Disabled] [Enabled]

### PCI Latency Timer [32]

Leave this field to the default setting [32] for best performance and stability.

### USB 1.1 Controllers [3 Controllers]

This field allows you to enable or disable the USB 1.1 controllers. Configuration options: [Disabled] [3 Controllers]

## USB 2.0 Controller [Enabled]

This field allows you to enable or disable the onboard USB 2.0 controller. Set to [Enabled] if you wish to install USB 2.0 devices. Configuration options: [Disabled] [Enabled]

## Primary VGA BIOS [PCI VGA Card]

This field allows you to select the primary graphics card. Configuration options: [PCI VGA Card] [AGP VGA Card]

## Onboard PCI Audio Controller [Enabled]

This field allows you to enable or disable the onboard PCI audio controller. Configuration options: [Disabled] [Enabled]

### 4.4.3.1 PCI IRQ Resource Exclusion

AwardBIOS Setup Utility			
Advanced			
PCI IRQ Resource Exclusion			Item Specific Help
IRQ 3	Reserved	[No/ICU]	Select [Yes] if this IRQ is required by a legacy ISA card and you are not using ICU; otherwise, select [No/ICU].
IRQ 4	Reserved	[No/ICU]	
IRQ 5	Reserved	[No/ICU]	
IRQ 7	Reserved	[No/ICU]	
IRQ 9	Reserved	[No/ICU]	
IRQ 10	Reserved	[No/ICU]	
IRQ 11	Reserved	[No/ICU]	
IRQ 12	Reserved	[No/ICU]	
IRQ 14	Reserved	[No/ICU]	
IRQ 15	Reserved	[No/ICU]	

F1 Help ↑↓ Select Item -/+ Change Values F5 Setup Defaults  
ESC Exit ↔ Select Menu Enter Select ► Sub-Menu F10 Save and Exit

## IRQ XX Reserved [No/ICU]

These fields indicate whether or not the displayed IRQ for each field is being used by a legacy (non-PnP) ISA card. The setting [No/ICU] for an IRQ field indicates that you are using the ISA Configuration Utility (ICU), and that this particular IRQ is NOT required by a legacy ISA card. Set the IRQ field to [Yes] if you install a legacy ISA card that requires a unique IRQ and you are NOT using ICU. Configuration options: [No/ICU] [Yes]

## 4.5 Power Menu

The Power menu allows you to reduce power consumption. This feature turns off the video display and shuts down the hard disk after a period of inactivity.

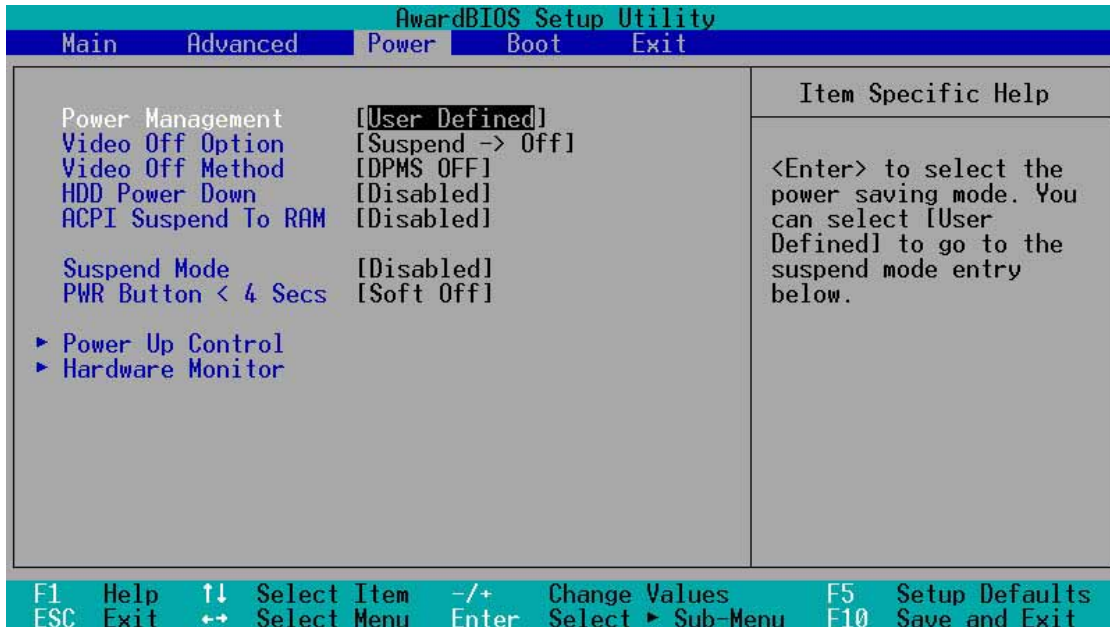

### Power Management [User Defined]

This field allows you to activate or deactivate the automatic power saving features. When set to [Disabled], the power management features do not function regardless of the other settings on this menu. The [User Defined] option allows you to set the period of inactivity before the system enters suspend mode. Refer to "Suspend Mode" item.

When set to [Max Saving], system power is conserved to its greatest amount. This setting automatically puts the system into suspend mode after a brief period of system inactivity. [Min Saving] allows the least power saving as the system enters suspend mode only after a long period of inactivity. Configuration options: [User Defined] [Disabled] [Min Saving] [Max Saving]



You should install the Advanced Power Management (APM) utility to keep the system time updated even when the computer enters suspend mode. In Windows 3.x and Windows 95, you need to install Windows with the APM feature. In Windows 98 or later, APM is automatically installed as indicated by a battery and power cord icon labeled "Power Management" in the Control Panel. Select the item "Advanced" in the Power Management Properties dialog box.

## **Video Off Option [Suspend -> Off ]**

This field determines when to activate the video off feature for monitor power management. Configuration options: [Always On] [Suspend -> Off]

## **Video Off Method [DPMS OFF]**

This field defines the video off features. The Display Power Management System (DPMS) feature allows the BIOS to control the video display card if it supports the DPMS feature. [Blank Screen] only blanks the screen. Use this for monitors without power management or “green” features.



---

Even if installed, your screen saver does not display when you select [Blank Screen] for the above field.

---

[V/H SYNC+Blank] blanks the screen and turns off vertical and horizontal scanning. Configuration options: [Blank Screen] [V/H SYNC+Blank] [DPMS Standby] [DPMS Suspend] [DPMS OFF] [DPMS Reduce ON]

## **HDD Power Down [Disabled]**

Shuts down any IDE hard disk drives in the system after a period of inactivity as set in this user-configurable field. This feature does not affect SCSI hard drives. Configuration options: [Disabled] [1 Min] [2 Min] [3 Min]...[15 Min]

## **ACPI Suspend To RAM [Disabled]**

This field allows you to enable or disable the ACPI Suspend-to-RAM feature. To support this feature, the +5VSB of the power supply should have the capacity to provide more than 720mA current. Configuration options: [Disabled] [Enabled]

## **Suspend Mode [Disabled]**

Sets the time period before the system goes into suspend mode. Configuration options: [Disabled] [1~2 Min] [2~3 Min] [4~5 min] [8~9 Min] [20 Min] [30 Min]

## **PWR Button < 4 Secs [Soft Off]**

When set to [Soft off], the ATX switch can be used as a normal system power-off button when pressed for less than 4 seconds. [Suspend] allows the button to have a dual function where pressing less than 4 seconds puts the system in sleep mode. Regardless of the setting, holding the ATX switch for more than 4 seconds powers off the system. Configuration options: [Soft off] [Suspend]

## 4.5.1 Power Up Control

AwardBIOS Setup Utility	
Power	
Power Up Control	Item Specific Help
AC Power Loss Restart [Disabled]	<Enter> to select whether or not to restart the system after AC power loss.
Wake/Power Up On Ext. Modem [Disabled]	
Power Up On PCI Card [Disabled]	
Power On By PS/2 Keyboard [Disabled]	
Power On By PS/2 Mouse [Disabled]	
Automatic Power Up [Disabled]	
F1 Help ↑↓ Select Item -/+ Change Values F5 Setup Defaults ESC Exit ↔ Select Menu Enter Select ▶ Sub-Menu F10 Save and Exit	

### AC PWR Loss Restart [Disabled]

This allows you to set whether or not to reboot the system after power interruptions. [Disabled] leaves your system off while [Enabled] reboots the system. [Previous State] sets the system back to the state it was before the power interruption. Configuration options: [Disabled] [Enabled] [Previous State]

### Wake/Power Up On Ext. Modem [Disabled]

This allows either settings of [Enabled] or [Disabled] for powering up the computer when the external modem receives a call while the computer is in Soft-off mode. Configuration options: [Disabled] [Enabled]



The computer cannot receive or transmit data until the computer and applications are fully running. Thus, connection cannot be made on the first try. Turning an external modem off and then back on while the computer is off causes an initialization string that turns the system power on.

### Power Up On PCI Card [Disabled]

When set to [Enabled], this parameter allows you to turn on the system through a PCI LAN or modem card. This feature requires an ATX power supply that provides at least 1A on the +5VSB lead. Configuration options: [Disabled] [Enabled]

### **Power On By PS/2 Keyboard [Disabled]**

This parameter allows you to use specific keys on the keyboard to turn on the system. This feature requires an ATX power supply that provides at least 1A on the +5VSB lead. Configuration options: [Disabled] [Space Bar] [Ctrl-Esc] [Power Key]

### **Power On By PS/2 Mouse [Disabled]**

When set to [Enabled], this parameter allows you to use the PS/2 mouse to turn on the system. This feature requires an ATX power supply that provides at least 1A on the +5VSB lead. Configuration options: [Disabled] [Enabled]

### **Automatic Power Up [Disabled]**

This allows an unattended or automatic system power up. You may configure your system to power up at a certain time of the day by selecting [Everyday] or at a certain time and day by selecting [By Date]. Configuration options: [Disabled] [Everyday] [By Date]



## 4.5.2 Hardware Monitor

AwardBIOS Setup Utility		
Power		
Hardware Monitor	Item Specific Help	
MB Temperature	<b>30°C/86°F</b>	<Enter> to switch between monitoring or ignoring.
CPU Temperature	41°C/105.5°F	
POWER Temperature	N/A	
Q-Fan Control	[Disabled]	
CPU Fan Speed	7500RPM	
Chassis Fan Speed	N/A	
Power Fan Speed	5335RPM	
VCORE Voltage	1.50V	
+3.3V Voltage	3.47V	
+5V Voltage	4.91V	
+12V Voltage	12.09V	

F1 Help ↑↓ Select Item -/+ Change Values F5 Setup Defaults  
ESC Exit ↔ Select Menu Enter Select ► Sub-Menu F10 Save and Exit

### MB Temperature [xxx°C/xxx°F]

### CPU Temperature [xxx°C/xxx°F]

### POWER Temperature [N/A]

The onboard hardware monitor automatically detects and displays the motherboard and CPU temperatures.

If your power supply comes with a two-pin thermal sensor cable, connect this cable to the TRPWR connector on the motherboard to allow BIOS to auto-detect the power supply temperature (see page 2-28 for the location of the TRPWR connector). The POWER temperature item shows N/A if you do not have the appropriate power supply. Select [Ignore] to disable the power temperature auto-detect function.

### Q-Fan Control [Disabled]

This item allows you to enable or disable the ASUS Q-Fan feature that smartly adjusts the fan speeds for more efficient system operation. When this field is set to [Enabled], the **Fan Speed Ratio** and **Speed Up/Down Response Time** items appear to allow selection of the appropriate fan speeds and the corresponding response time. Configuration options: [Disabled] [Enabled]



AwardBIOS Setup Utility	
Power	
Hardware Monitor	Item Specific Help
MB Temperature	30°C/86°F
CPU Temperature	41°C/105.5°F
POWER Temperature	N/A
Q-Fan Control	[Enabled]
Fan Speed Ratio	[10/15]
Speed Up/Down Response Time	[4 Sec/8 Sec]
CPU Fan Speed	7500RPM

### Fan Speed Ratio [10/15]

This item allows you to select the appropriate fan speed ratio for the system. The default [10/15] is the minimum fan speed ratio. Select a higher ratio if you installed additional devices and the system requires more ventilation. This item appears only when the **Q-Fan Control** item is set to [Enabled]. Configuration options: [10/15] [11/15] [12/15] [13/15] [14/15] [Full Speed]

### Speed Up/Down Response Time [4 Sec/8 Sec]

This item indicates the time period before the fan speeds adjust to the value set in the **Fan Speed Ratio** field. This item appears only when the **Q-Fan Control** item is set to [Enabled]. Configuration options: [1 Sec/2 Sec] [2 Sec/4 Sec] [3 Sec/6 Sec] [4 Sec/8 Sec]

### CPU Fan Speed [xxxxRPM] or [N/A]

### Chassis Fan Speed [xxxxRPM] or [N/A]

### Power Fan Speed [xxxxRPM] or [N/A]

The onboard hardware monitor automatically detects and displays the CPU, chassis, and power fan speeds in rotations per minute (RPM). If any of the fans is not connected to the motherboard, the specific field shows N/A.

### VCORE Voltage, +3.3V Voltage, +5V Voltage, +12V Voltage

The onboard hardware monitor automatically detects the voltage output through the onboard voltage regulators.



If any of the monitored items is out of range, the following error message appears: "Hardware Monitor found an error. Enter Power setup menu for details". You will then be prompted to "Press F1 to continue or DEL to enter SETUP".

## 4.6 Boot Menu

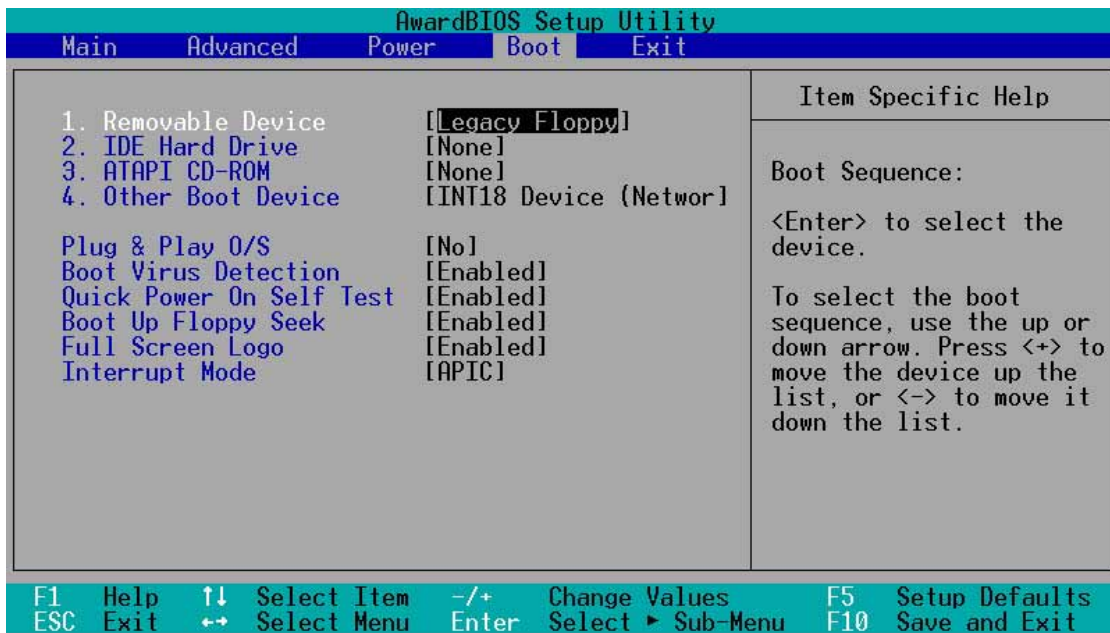

### Boot Sequence

The Boot menu allows you to select among the four possible types of boot devices listed using the up and down arrow keys. By using the <+> or <Space> key, you can promote devices and by using the <-> key, you can demote devices. Promotion or demotion of devices alters the priority which the system uses to search for a boot device on system power up. Configuration fields include Removable Devices, IDE Hard Drive, ATAPI CD-ROM, and Other Boot Device.

### Removable Device [Legacy Floppy]

Configuration options: [Disabled] [Legacy Floppy] [LS-120] [ZIP] [ATAPI MO]

### IDE Hard Drive

This field allows you to select which IDE hard disk drive to use in the boot sequence. Pressing [Enter] will show the product IDs of all connected IDE hard disk drives.

### ATAPI CD-ROM

This field allows you to select which ATAPI CD-ROM drive to use in the boot sequence. Pressing [Enter] will show the product IDs of all your connected ATAPI CD-ROM drives.

### **Other Boot Device Select [INT18 Device (Network)]**

Configuration options: [Disabled] [SCSI Boot Device] [INT18 Device (Network)]

### **Plug & Play O/S [No]**

This field allows you to use a Plug-and-Play (PnP) operating system to configure the PCI bus slots instead of using the BIOS. When [Yes] is selected, interrupts may be reassigned by the OS. If you installed a non-PnP OS or if you want to prevent reassigning of interrupt settings, keep the default setting [No]. Configuration options: [No] [Yes]

### **Boot Virus Detection [Enabled]**

This field allows you to set boot virus detection, ensuring a virus-free boot sector. The system halts and displays a warning message when it detects a virus. If this occurs, you can either allow the operation to continue or use a virus-free bootable floppy disk to restart and investigate your system. Configuration options: [Disabled] [Enabled]

### **Quick Power On Self Test [Enabled]**

This field speeds up the Power-On-Self Test (POST) routine by skipping retesting a second, third, and fourth time. Configuration options: [Disabled] [Enabled]

### **Boot Up Floppy Seek [Enabled]**

When enabled, the BIOS will seek the floppy disk drive to determine whether the drive has 40 or 80 tracks. Configuration options: [Disabled] [Enabled]

### **Full Screen Logo [Enabled]**

This allows you to enable or disable the full screen logo display feature. Configuration options: [Disabled] [Enabled]



---

Make sure that the above item is set to [Enabled] if you wish to use the ASUS MyLogo2™ feature.

---

### **Interrupt Mode [APIC]**

The Advanced Programmable Interrupt Controller (APIC) setting allows you to distribute interrupt routings other than the 16 IRQs. The Programmable Interrupt Controller (PIC) setting allows you to use the 16 IRQs only. Configuration options: [PIC] [APIC]

## 4.7 Exit Menu

When you have made all of your selections from the various menus in the Setup program, save your changes and exit Setup. Select Exit from the menu bar to display the following menu.

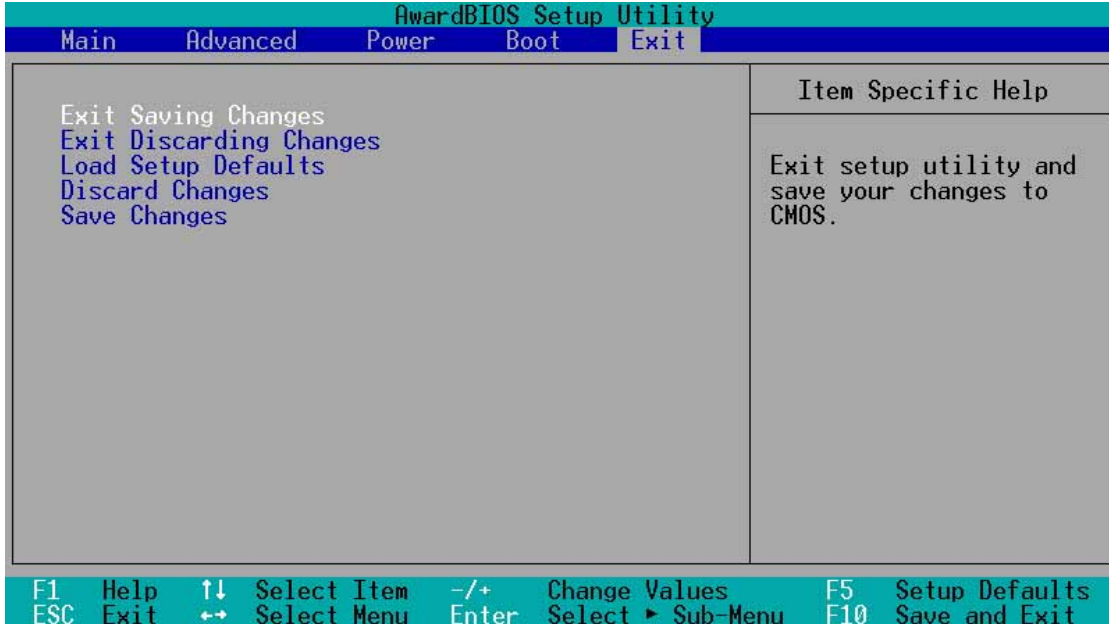

Pressing <Esc> does not immediately exit this menu. Select one of the options from this menu or <F10> from the legend bar to exit.

### Exit Saving Changes

Once you are finished making your selections, choose this option from the Exit menu to ensure the values you selected are saved to the CMOS RAM. The CMOS RAM is sustained by an onboard backup battery and stays on even when the PC is turned off. When you select this option, a confirmation window appears. Select [Yes] to save changes and exit.



If you attempt to exit the Setup program without saving your changes, the program prompts you with a message asking if you want to save your changes before exiting. Pressing <Enter> saves the changes while exiting.

### Exit Discarding Changes

Select this option only if you do not want to save the changes that you made to the Setup program. If you made changes to fields other than system date, system time, and password, the BIOS asks for a confirmation before exiting.

## **Load Setup Defaults**

This option allows you to load the default values for each of the parameters on the Setup menus. When you select this option or if you press <F5>, a confirmation window appears. Select [Yes] to load default values. Select Exit Saving Changes or make other changes before saving the values to the non-volatile RAM.

## **Discard Changes**

This option allows you to discard the selections you made and restore the previously saved values. After selecting this option, a confirmation appears. Select [Yes] to discard any changes and load the previously saved values.

## **Save Changes**

This option saves your selections without exiting the Setup program. You can then return to other menus and make further changes. After you select this option, a confirmation window appears. Select [Yes] to save any changes to the non-volatile RAM.





# ***Chapter 5***

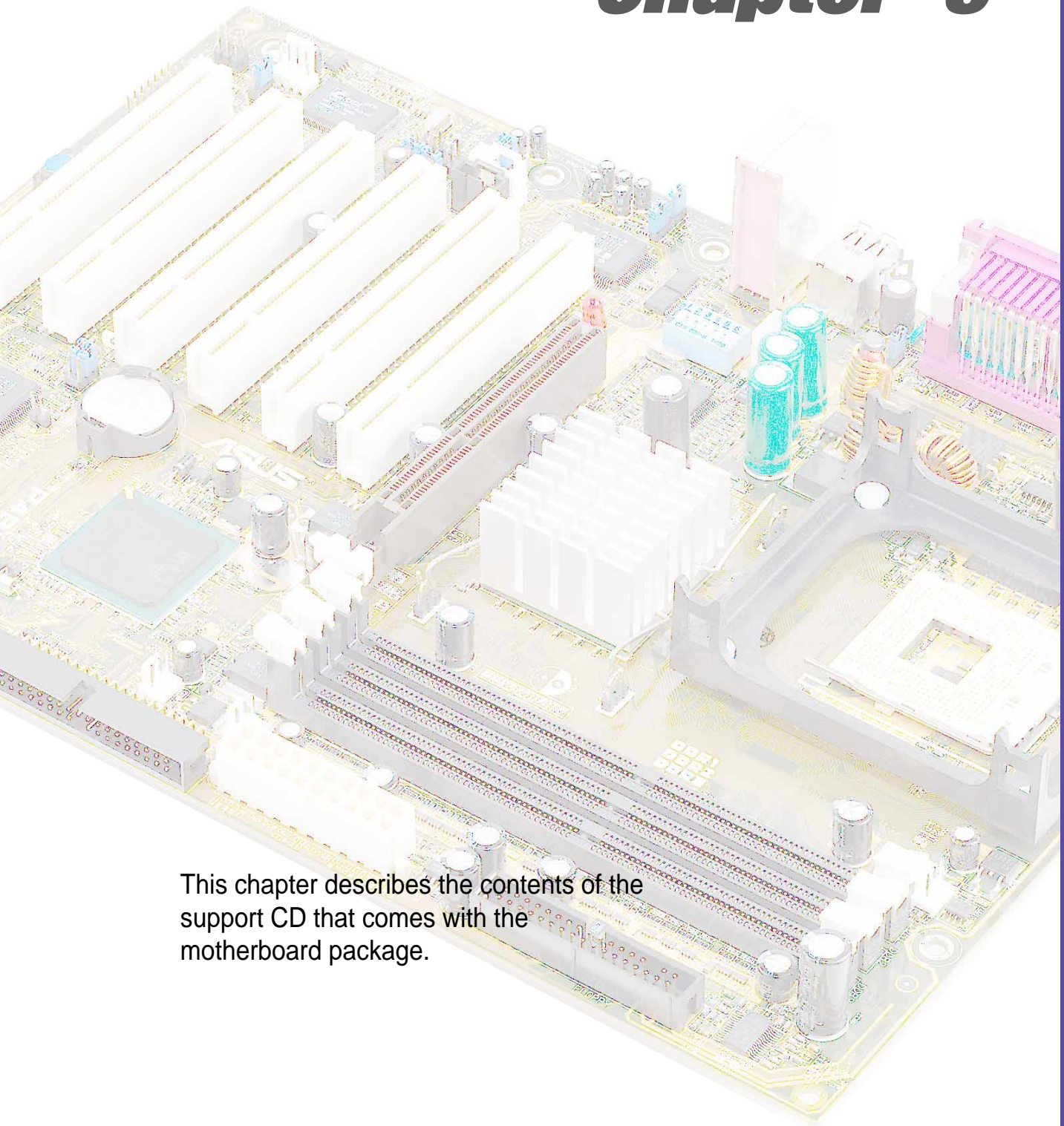

This chapter describes the contents of the support CD that comes with the motherboard package.

## **Software support**



## **Chapter summary**

<b>5.1</b>	<b>Install an operating system .....</b>	<b>5-1</b>
<b>5.2</b>	<b>Support CD information .....</b>	<b>5-1</b>
<b>5.3</b>	<b>Software information .....</b>	<b>5-9</b>

## 5.1 Install an operating system

This motherboard supports Windows 98/ME/NT/2000/XP and OS/2 operating system (OS). Always install the latest OS version and corresponding updates so you can maximize the features of your hardware.



---

Because motherboard settings and hardware options vary, use the setup procedures presented in this chapter for general reference only. Refer to your OS documentation for more information.

---

## 5.2 Support CD information

The support CD that came with the motherboard contains useful software and several utility drivers that enhance the motherboard features.



---

The contents of the support CD are subject to change at any time without notice. Visit the ASUS website for updates.

---

### 5.2.1 Running the support CD

To begin using the support CD, simply insert the CD into your CD-ROM drive. The CD automatically displays the welcome screen and the installation menus if Autorun is enabled in your computer.



If the welcome screen did not appear automatically, locate and double-click on the file ASSETUP.EXE from the BIN folder in the support CD to display the menus.

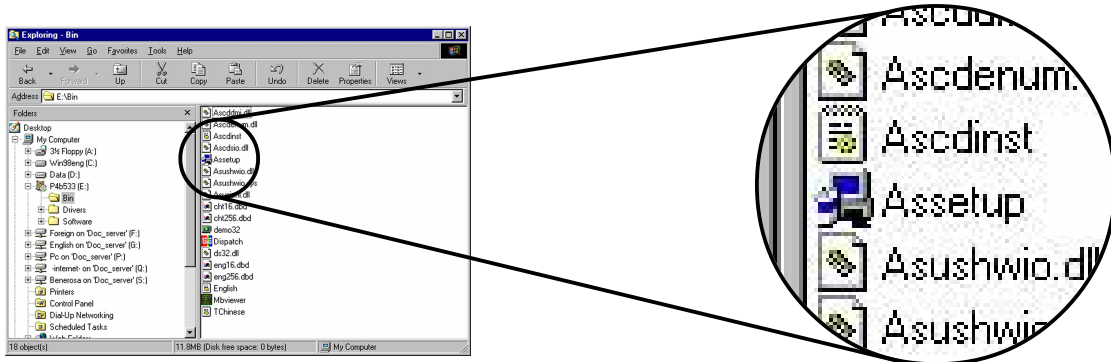

## 5.2.2 Main menu

From the welcome screen, the program takes you directly to the main menu. The main menu displays an image of the motherboard, and the buttons and icons that link you to the software, drivers, utilities, and other information contained in the support CD.

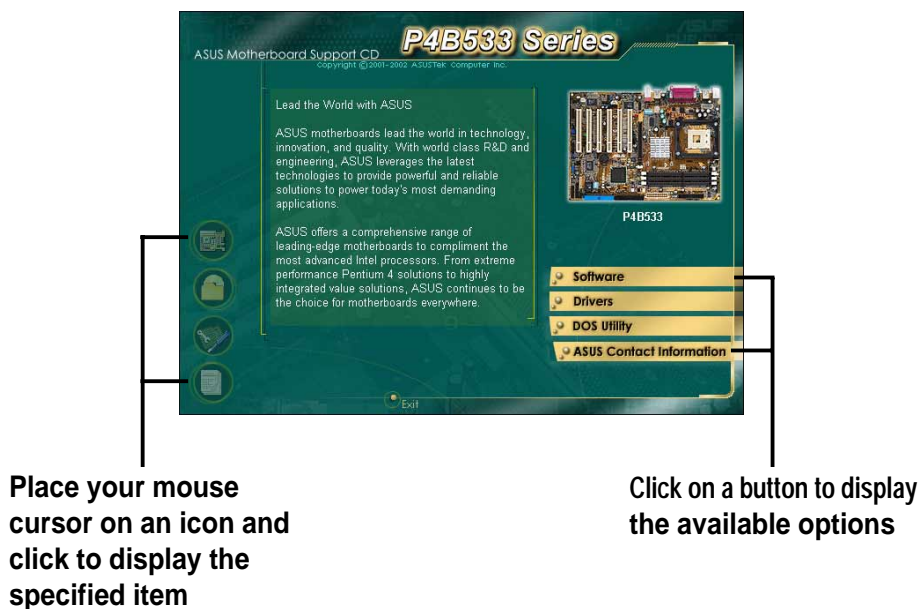

## 5.2.3 Software menu

The software menu shows the applications and other software that the motherboard supports. The highlighted items indicate that they are available for your motherboard. Simply click on a specific item then follow the installation wizard to install it.

The software menu is composed of two screens. Click on the **Next** button on the lower right corner of the first screen to display the second menu screen. To return to the first menu screen, click on the **Back** button on the lower right corner of the second screen.

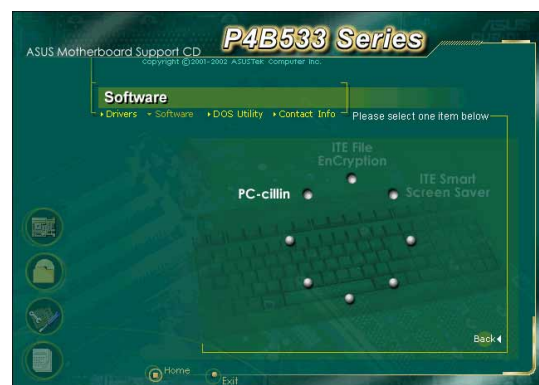

### ASUS Update

This program allows you to download the latest version of the BIOS from the ASUS website.



Before using the ASUS Update, make sure that you have an Internet connection so you can connect to the ASUS website.

### ASUS Screen Saver

This item installs the ASUS screen saver.

### ASUS PC Probe

This smart utility monitors the fan speed, CPU temperature, and system voltages, and alerts you on any detected problems. This utility helps you keep your computer at a healthy operating condition.

## **Winbond Voice Editor**

This program is for recording and customizing wave files for the ASUS POST Reporter™. Use this program if you wish to change the default vocal POST messages. See section “3.2 Vocal POST messages” for a list of the default messages.

## **Cyberlink Video and Audio Applications**

This item installs the Cyberlink PowerPlayer SE 5.0 and Cyberlink VideoLive Mail 4.0.

## **Direct X**

This item installs the Microsoft V8.0a driver.

## **E-Color 3Deep**

This item installs the 3Deep software. 3Deep is the first application that gives online gamers the competitive edge in multi-player skirmishes. This application removes dark washed-out graphics to deliver true vibrant colors.

## **Acrobat Reader**

This item installs the Adobe Acrobat Reader V5.0. The Acrobat Reader software is for viewing files saved in Portable Document Format (PDF).

## **PC-cillin**

This item installs the PC-cillin 2002 V9.02 anti-virus software. View the PC-cillin online help for detailed information.

## 5.2.4 Drivers menu

The drivers menu shows the available device drivers if the system detects installed devices. Install the necessary drivers to activate the devices.

The drivers menu is composed of two screens. Click on the **Next** button on the lower right corner of the first screen to display the second menu screen. To return to the first menu screen, click on the **Back** button on the lower right corner of the second screen.



### INF Driver

This item installs the Intel® Chipset Software Installation Utility that enables Plug-n-Play INF support for Intel chipset components. This utility installs to the target system the Windows INF files that outline to the operating system how the chipset components will be configured.

You may install this utility in three modes: interactive, silent, and unattended preload. The interactive mode requires user input during installation. This is not required in the silent and unattended preload modes.

Refer to the online help or readme file that came with the utility.

### Intel® Application Accelerator

This item installs the Intel Application Accelerator for Microsoft® Windows® 98/98SE/ME/NT4.0/2000. This program is designed to improve performance of the storage sub-system and overall system performance.



---

Install the INF Driver before installing the Intel Application Accelerator.

---

## Audio utility

This item installs the C-Media audio controller.

## Smart Card Reader

This item installs the Smart Card Reader device driver.

## AGP

This item installs the AGP driver.

## USB2



The Microsoft USB 2.0 driver has not been officially released as of the support CD production date. Please download the USB 2.0 driver from the Microsoft website ([www.microsoft.com](http://www.microsoft.com)) to upgrade your USB 1.1 ports to USB 2.0.

## 5.2.5 DOS Utility menu

The DOS utility menu shows the Flash BIOS utility DOS version. You can use this utility if you wish to update the BIOS.

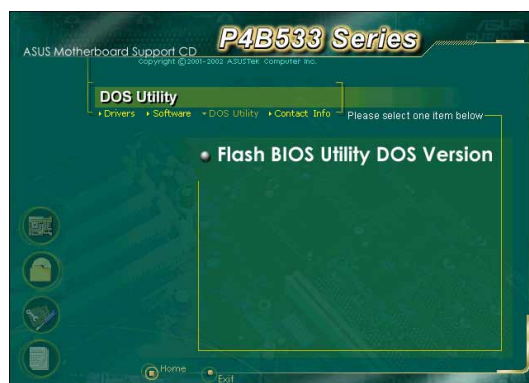

## 5.2.6 ASUS Contact Information

Clicking the ASUS Contact Information button displays as stated. You may also find this information on page x of this user guide.

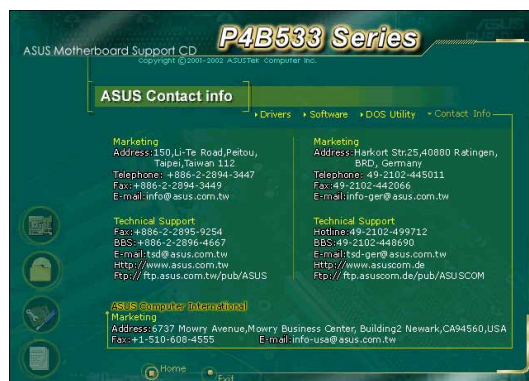



## 5.2.7 Other information

The icons on the left side of the screen give additional information on the motherboard and the contents of the support CD. This section shows the pop-up windows that appear when you click the icons.

### Motherboard Info

The window displays the general specifications of the P4B533 motherboard.

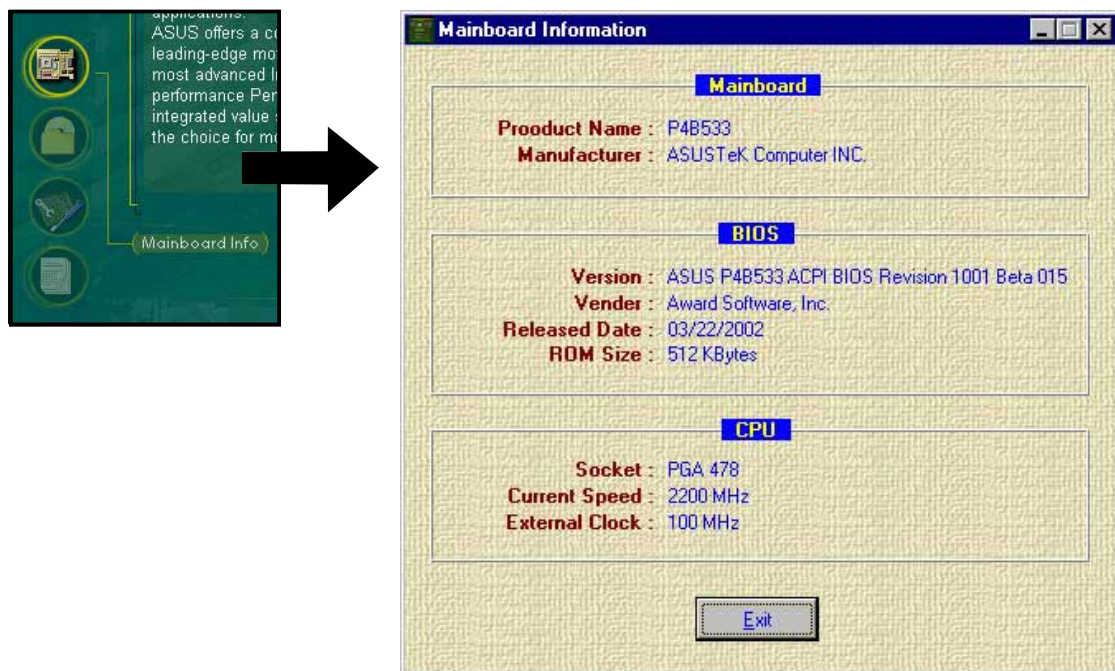

### Browse this CD

The window displays the support CD contents in graphical format.

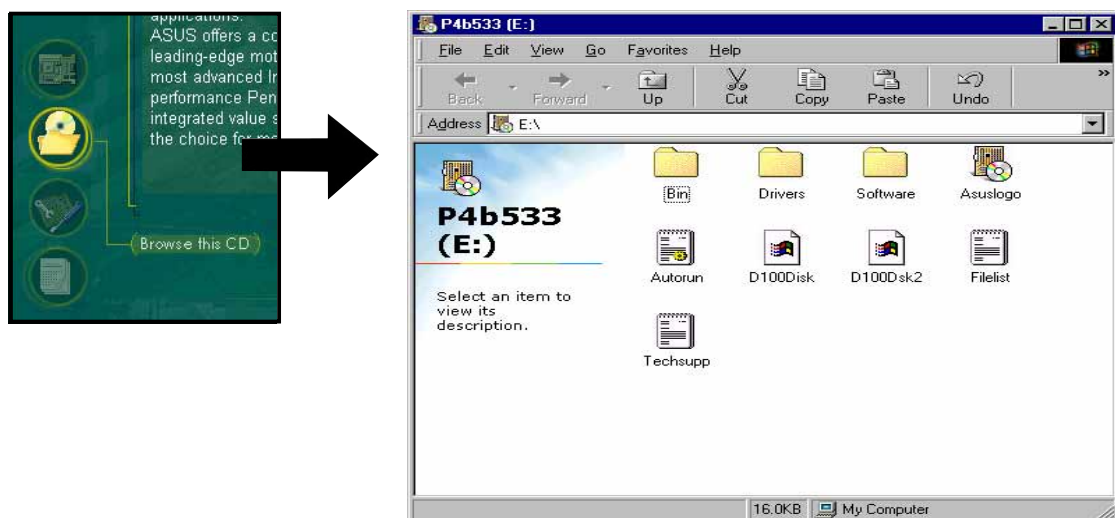

## Technical Support Form

The window displays the ASUS Technical Support Request Form that you have to fill up when requesting technical support.

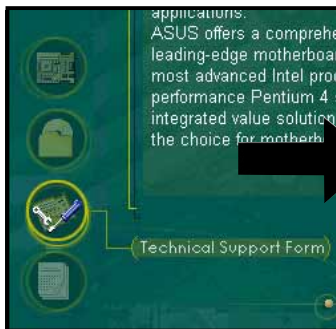

Techsupp - Notepad

ASUSTek TECHNICAL SUPPORT REQUEST FORM DATE:

=====

ORIGINATOR DESCRIPTION

-----

COMPANY NAME : CONTACT NAME :  
PHONE (AREA) : FAX # (AREA) :  
EMAIL ADDRESS :

-----

HARDWARE DESCRIPTION

-----

MOTHERBOARD : REVISION # : BIOS:#401A0-  
CPU BRAND : SPEED(MHz) :  
DRAM BRAND : SPEED(ns) : SIZE(MB) :  
CACHE BRAND : SPEED(ns) : SIZE(KB) :  
HARD DISK : MODEL NAME : SIZE(MB) :  
CDROM BRAND : MODEL NAME :  
BACKUP BRAND : MODEL NAME : SIZE(MB) :  
OTHER STORAGE : MODEL NAME : SIZE(MB) :

-----

ADD-IN CARD DESCRIPTION (MODEL NAME/VENDOR)

-----

(E)ISA SLOT 1 :  
(E)ISA SLOT 2 :  
(E)ISA SLOT 3 :  
(E)ISA SLOT 4 :  
PCI SLOT 1 :  
PCI SLOT 2 :  
PCI SLOT 3 :  
PCI SLOT 4 :  
PCI SLOT 5 :

-----

SOFTWARE DESCRIPTION

-----

OPERATING SYSTEM :  
APPLICATION SOFTWARE :  
DEVICE DRIVERS :

-----

PROBLEM DESCRIPTION (WHAT PROBLEMS AND UNDER WHAT SITUATIONS)

-----

## Readme

The window displays the contents of the support CD and a brief description of each in text format.

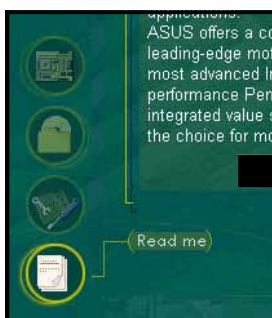

Filelist - Notepad

File List for the included support software for P4B series motherboard

-----

File Name	Description
--Drivers	
-Audio	
-ADI	-SoundMAX Integrated Digital Audio Driver
-NT40	-AD1881 SoundMAX Windows NT 4.0 Driver U4.02.00.0046.
-VDH	-AD1881 SoundMAX VDH Driver U5.12.01.3027.
-ALC201	-Avance AC'97 Drivers and Applications U4.55
-Linux	-Audio Driver for Linux.
-Windows	-Audio Drivers for Windows OS.
-AP	-Applications
-Win2000	-Audio Driver for Windows 2000 U5.10.00.3560.
-Win98SE	-Windows 98 SE VDH Driver U5.10.00.3560.
-Win9x	-Windows 95/98 UxD Driver U4.05.00.3008 and Wavetable Driver U3.1.0.0.
-WinME	-Windows ME VDH Driver U5.10.00.3560.
-WinNT4	-Windows NT 4.0 Audio Driver U4.03.00.3015 and Wavetable Driver U4.03.00.2001.
-C-Media	-C-Media CHI8738/PCI-SX Audio Chip Driver U2.63
-Doslrv	-Audio Driver for Dos.
-Linux	-Audio Driver for Linux.
-Manual	-Audio manual.
-NT40	-Windows NT 4.0 Audio Drivers U4.01.0229.
-W2K-ME	-Windows 2000/ME Audio Driver U5.12.01.0624.
-W95-98	-Windows 95/98 Audio UxD Drivers U4.06.1095d.
-BusMastr	
-NT351	-Bus Master IDE Driver U1.70 for WinNT3.51.
-UltraAta	-Intel Ultra ATA Storage Driver U6.10.011 for Windows 95/98/ME/NT40/2000.
-Chipset	
-Inf	-Intel(R) Chipset Software Installation Utility U3.10.1011.
-Lan	
-Intel	-Intel(R) PRO/100 VE Network Connection.
-RTL8139	-Realtek RTL8139C PCI Fast Ethernet NIC Driver U5.376.0529.2000
-Win2000	-Realtek RTL8139C PCI Fast Ethernet NIC Windows 2000 Driver.
-Win95	-Realtek RTL8139C PCI Fast Ethernet NIC Windows 95 Driver.
-Win98	-Realtek RTL8139C PCI Fast Ethernet NIC Windows 98 Driver.
-Winme	-Realtek RTL8139C PCI Fast Ethernet NIC Windows ME Driver.

## 5.3 Software information

Most of the applications in the support CD have wizards that will conveniently guide you through the installation. View the online help or readme file that came with the software for more information.

This section provides details on the software applications that the motherboard supports.

### 5.3.1 ASUS Update

The ASUS Update is a utility that allows you to update the motherboard BIOS and drivers. This utility requires an Internet connection either through a network or an Internet Service Provider (ISP).

Follow these steps to use the ASUS Update.

1. Launch the utility from your Windows Start menu:

**Programs/AsusUpdate Vx.xx.xx/  
AsusUpdate**

The ASUS Update initial screen appears.

2. Select your desired update method, then click Next.

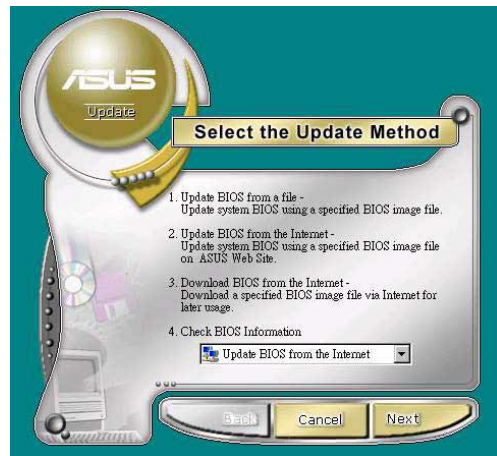

3. If you selected updating/downloading from the Internet, select the ASUS FTP site nearest you to avoid network traffic, or choose Auto Select. Click Next.

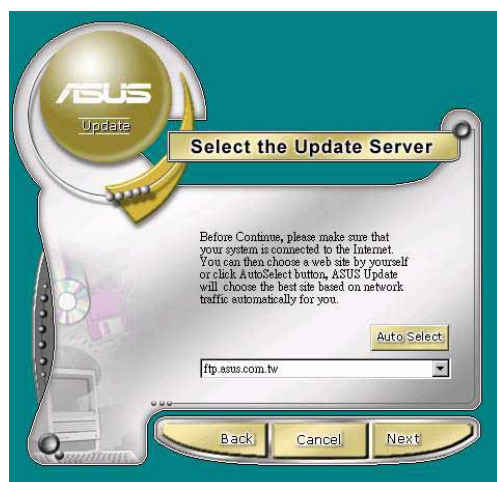

4. From the FTP site, select the BIOS version that you wish to download. Click Next.
5. Follow the instructions on the succeeding screens to complete the update process.

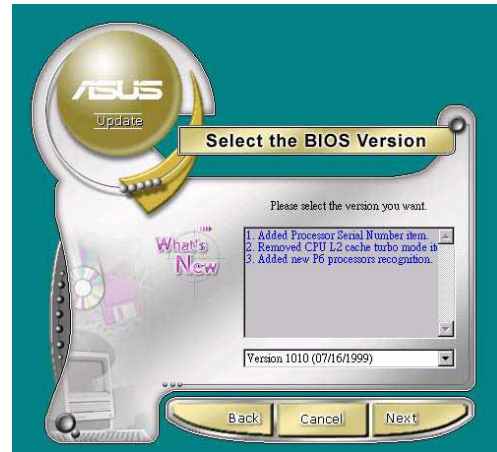

If you selected the option to update the BIOS from a file, a window pops up prompting you to locate the file. Select the file, click Save, then follow the screen instructions to complete the update process.

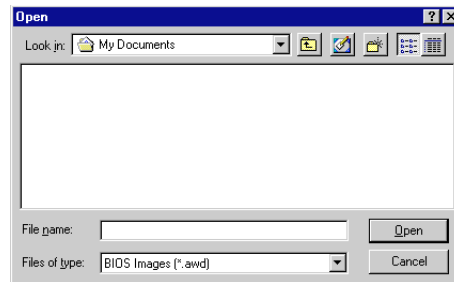

### 5.3.2 ASUS MyLogo2™

The ASUS MyLogo2™ is automatically installed when you install the ASUS Update utility from the software menu. See section “5.2.3 Software menu”.



Before using ASUS MyLogo2 feature, use the AFLASH utility to make a copy of your original BIOS file, or obtain the latest BIOS version from the ASUS website.

Make sure that the BIOS item Full Screen Logo is set to [Enabled] is you wish to use ASUS MyLogo2. See page 4-35.

Follow these steps to use ASUS MyLogo2.

1. Launch the ASUS Update utility. See section “5.3.1 ASUS Update.”
2. When prompted for the BIOS update method, select the option “Update BIOS from a file.”
3. Specify the location of the BIOS file, such as from a floppy disk. Click Next.





- From the selection that appears, choose a logo image. Click Next.



If you wish, you may create your own boot logo image in GIF, JPG, or BMP file formats.



- When you click on an image, it displays larger on the MyLogo2 screen.



MyLogo2 may not support too complex images. If you encounter any problems on complex images, try using a simpler image. You may also use a photo editing software to shrink the complex image, lay it over a one-color 640x480 pixel background, and save the image with the background. When you use the image, it will appear smaller and centered on the screen.

- The next screen prompts you to flash the original BIOS to update it with the new boot logo. Click Flash to update the BIOS.
- When finished, click Exit, then reboot your computer. Your system boots with the new boot logo.



Instead of starting from ASUS Update, you may also launch ASUS MyLogo2 directly from the Windows Start menu to change your BIOS boot logo. After you have modified the BIOS file with the new logo, use the ASUS Update utility to upload the new BIOS.

### 5.3.3 ASUS PC Probe

The ASUS PC Probe is a convenient utility to continuously monitor your computer system's vital components, such as fan rotations, voltages, and temperatures. It also has a utility that lets you review useful information about your computer, such as hard disk space, memory usage, and CPU type, CPU speed, and internal/external frequencies through the DMI Explorer.

#### Starting ASUS PC Probe

When ASUS PC Probe starts, a splash screen appears allowing you to select whether to show the screen again when you open PC Probe or not. To bypass this startup screen, clear the **Show up in next execution** check box.



To launch **ASUS PC Probe**, click the Windows **Start** button, point to **Programs**, and then **ASUS Utility**, and then click **Probe Vx.xx**.

The PC Probe icon  appears on the taskbar system tray indicating that ASUS PC Probe is running. Clicking the icon allows you to see the status of your PC.



## Using ASUS PC Probe

### Monitoring

#### Monitor Summary

Shows a summary of the items being monitored.

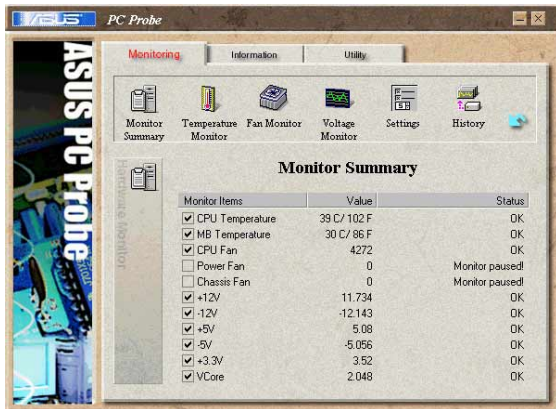

#### Temperature Monitor

Shows the PC temperature (for supported processors only).

Temperature Warning threshold adjustment  
(Move the slider up to increase the threshold level or down to decrease the threshold level)

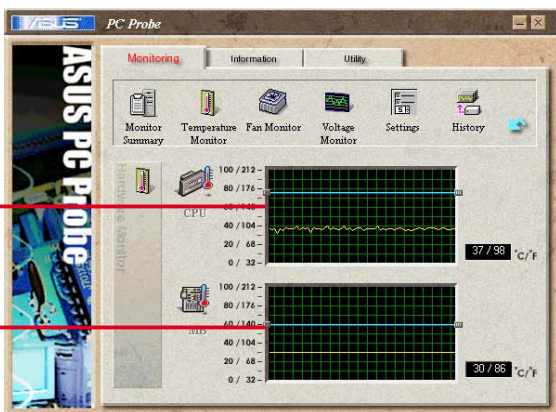

#### Fan Monitor

Shows the PC fan rotation.

Fan Warning threshold adjustment  
(Move the slider up to increase the threshold level or down to decrease the threshold level)

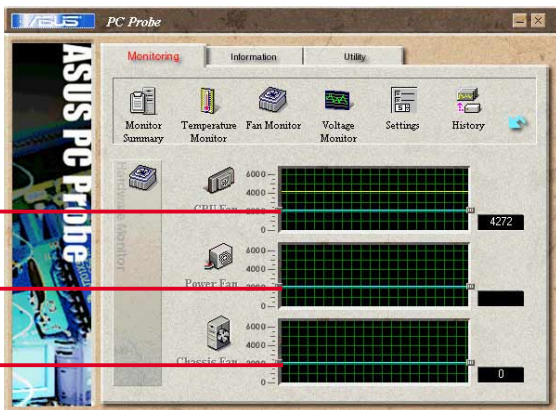

#### Voltage Monitor

Shows the PC voltages.

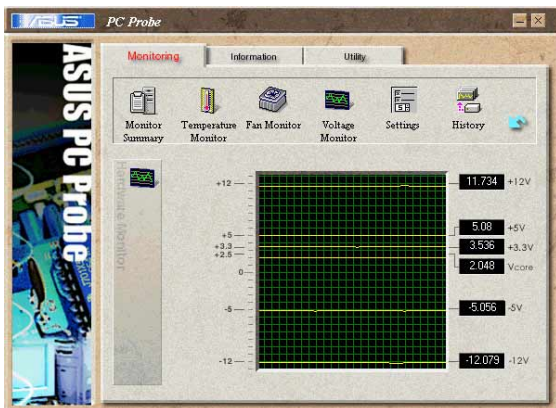



## Settings

Lets you set threshold levels and polling intervals or refresh times of the PC's temperature, fan rotation, and voltages.



### CPU Cooling System Setup

Lets you select when to enable software CPU cooling. When **When CPU Overheated** is selected, the CPU cooling system is enabled whenever the CPU temperature reaches the threshold value.

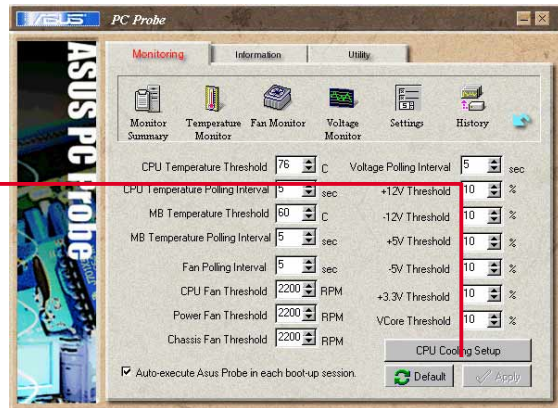

## History

Lets you record the monitoring activity of a certain component of your PC for future reference.

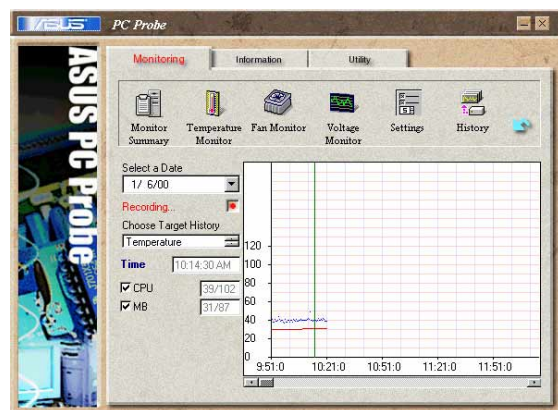

## Fan Control

Lets you enable/disable Smart Fan Control. Smart Fan Control adjusts the fan speed automatically based on the current CPU temperature and predefined threshold.



## Hard Drives

Shows the used and free space of the PC's hard disk drives and the file allocation table or file system used.

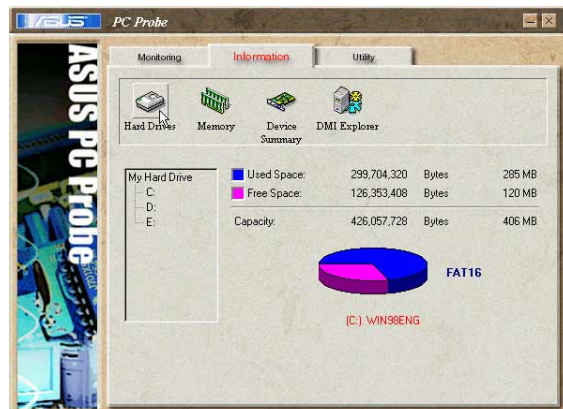

## Information

### Memory

Shows the PC memory load, memory usage, and paging file usage.

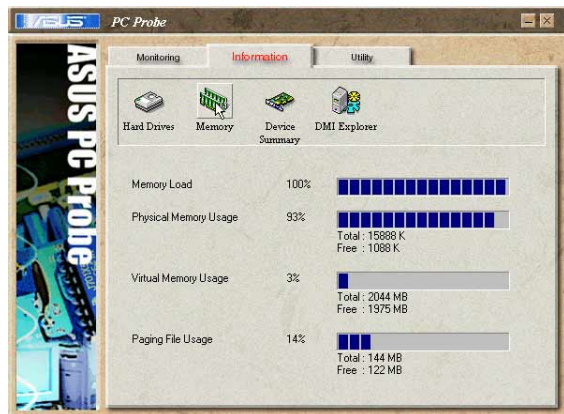

### Device Summary

Shows a summary of devices present in your PC.



### DMI Explorer

Shows information pertinent to the PC, such as CPU type, CPU speed, and internal/external frequencies, and memory size.



## Utility

Lets you run programs outside of the ASUS Probe modules. To run a program, click **Execute Program**. **NOTE:** This feature is currently unavailable.

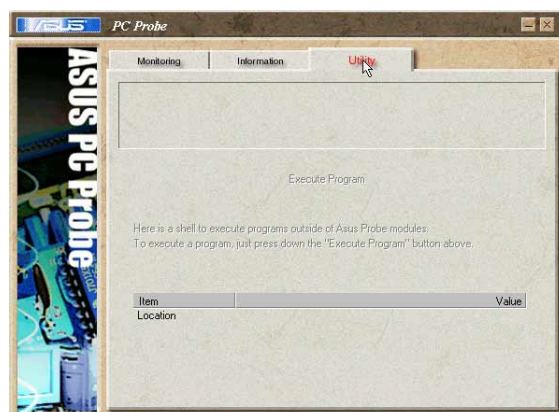

## ASUS PC Probe Task Bar Icon

Right clicking the PC Probe icon brings up a menu to open or exit ASUS PC Probe and pause or resume all system monitoring.



When the ASUS PC Probe senses a problem with your PC, portions of the ASUS PC Probe icon changes to red, the PC speaker beeps, and the ASUS PC Probe monitor appears.





## 5.3.4 E-Color 3Deep

The 3Deep color tuner is designed to match your CRT or LCD color monitor and maximize the color quality of all graphical applications. You may also tune your internet applications to match “true” internet source colors with the color displayed on the monitor.

### 3Deep Control Panel

Using the Windows **Start** button, activate the **3Deep Control Panel** program from the **3Deep Applications** group on the **Main Program** menu.

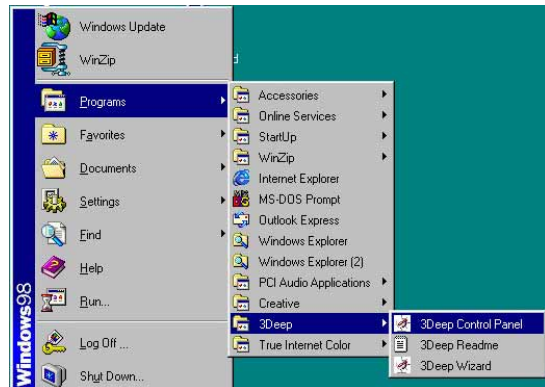

The control panel offers access to the **Color Wizard** tuning program, a **Game Gamma** setting and a **Tweak** slider for brightness adjustment.



## 3Deep Color Tuning

1. Select the type of monitor connected to the computer, either **CRT** or **LCD**.



2. Follow the instructions to manually adjust the **brightness** level of the monitor.



3. Select the faintest of the three colors: **blue**, **red**, and **green**.

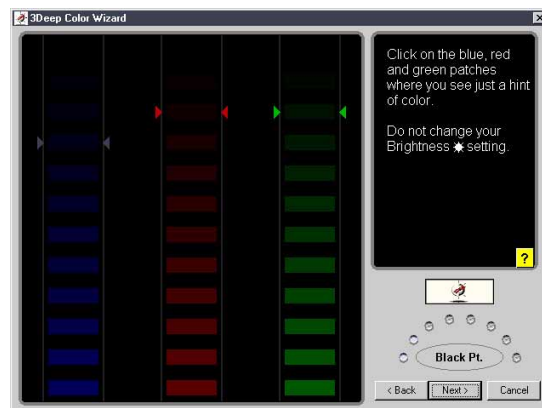

4. Select the color squares that most closely blend and match with the background.

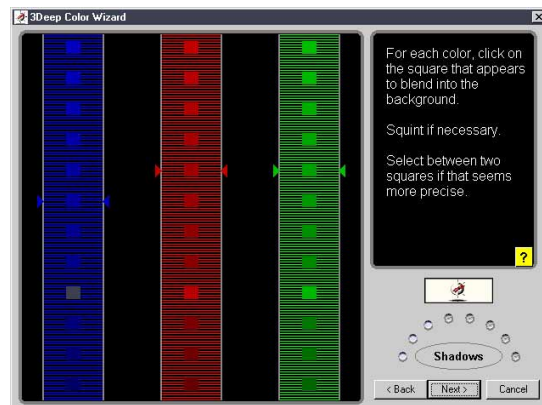

5. The next step repeats the color matching process to achieve full color quality.

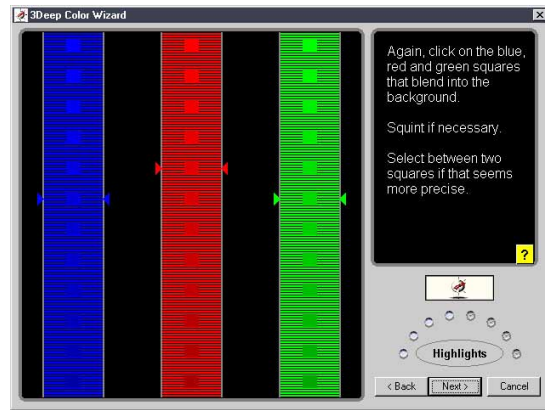

6. When a message appears indicating that the tuning process is complete, click **Finish**.

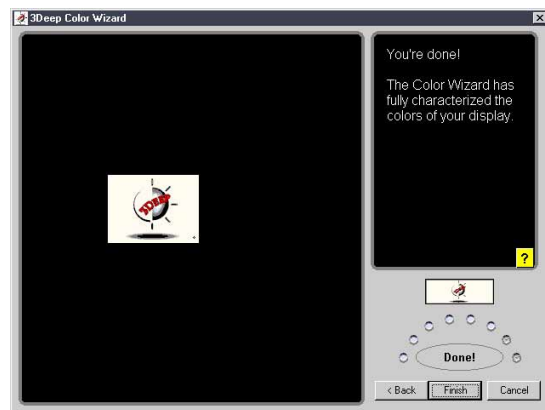

7. Click on the **Set Up Now** button to connect to the Internet. Follow the screen instructions to set up True Internet Color.



## 5.3.5 Winbond Voice Editor

The Winbond Voice Editor software allows you to customize the vocal POST messages. Install the software from the software menu in the support CD. See section “5.2.3 Software menu”.



---

To avoid conflicts, do not run the Winbond Voice Editor while running the ASUS PC Probe.

---

Follow these steps to use the Winbond Voice Editor.

### Launching the program

Launch the program either from the Winbond Voice Editor icon on your desktop, or from the Windows Start menu, **Programs/Winbond Voice Editor/Voice Editor**.

The Winbond Voice Editor screen appears.

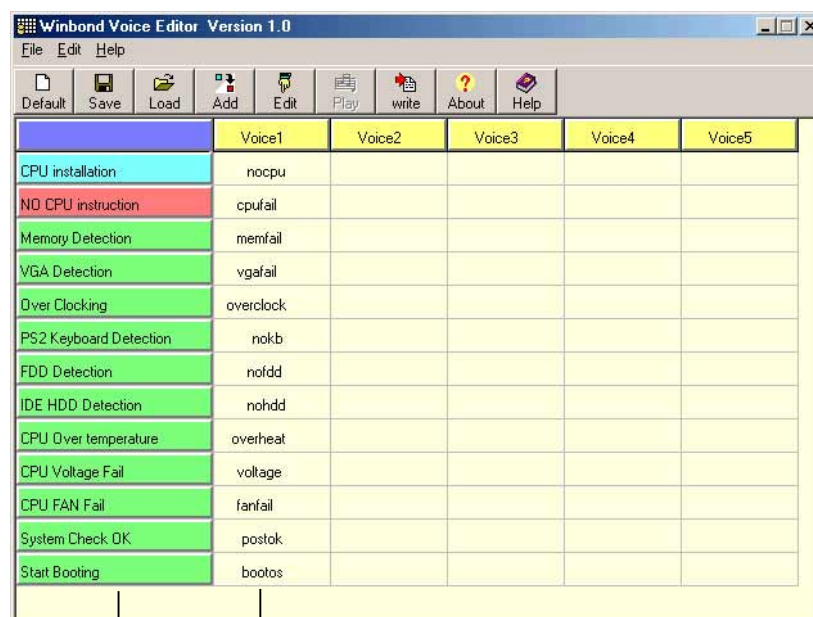

Default Messages

POST Events

### Playing the default wave files

To play the default wave files, simply click on a POST event on the left side of the screen, then click the Play button.



---

The default language setting is English.

---



## Changing the default language

1. Click on the Load button. a window showing the available languages appears.
2. Select your desired language then click Open. The event messages for the language you selected appear on the Voice Editor screen.

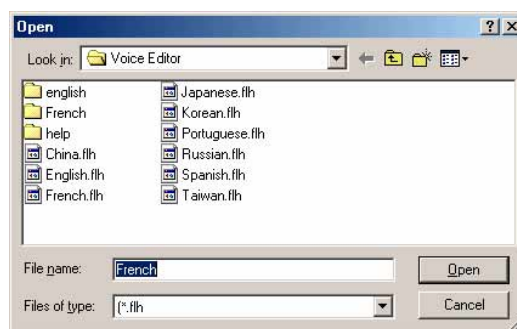

For some languages, not all events have a corresponding message due to file size constraints.

3. Click on the Write button to update the EEPROM.
4. Click Yes on the confirmation window that appears.



The next time you boot your computer, the POST messages are announced in the language that you selected .

## Customizing your POST messages

If your language is not in the selection or if you wish to record your own POST messages to replace the pre-installed wave files, you may easily do so.

Follow these steps to customize your POST messages.

1. Launch the Voice Editor and take note of the list of POST events on the leftmost column of the screen.
2. Prepare your message for each event.



The total compressed size for all the wave files must not exceed 1Mbit, so make your messages as short as possible.

3. Use a recording software, such as Windows Recorder, to record your messages.
4. Save the messages as wave files (.WAV). It is recommended that you save your files in low quality to keep them small. For example, use 8-bit, mono quality at 22Khz sampling rate.



You may want to create a separate folder for your wave files so you can locate them easily in one place.

5. From the Voice Editor screen, click on the Add button to display the Add Wave File window.
6. Copy the wave files that you recorded to the database. Close the window when done.

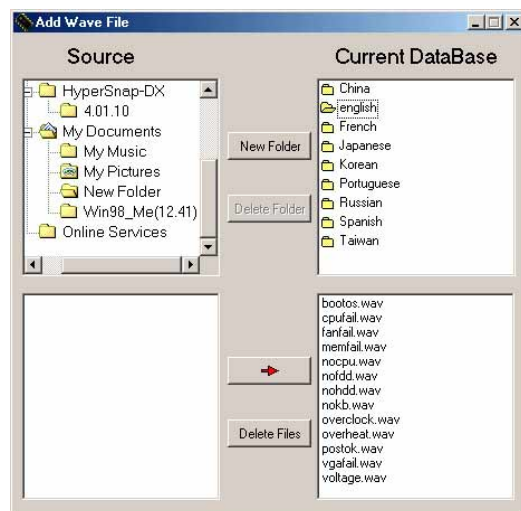

7. Click a POST event on the Voice Editor screen, then on the Edit button. The Event Sound Editor window appears.
8. Locate and select your wave file for the event then click on the arrow opposite Voice1. The file you selected appears on the space next to it.
9. Click OK to return to the Voice Editor screen.
10. Do steps 7 to 9 for the other events.
11. When done, click the Save button. A window appears prompting you to save your configuration.
12. Type a file name with a .flh extension, then click Save.
13. Click on the Write button to compress the file and copy into the EEPROM.
14. Click Yes on the confirmation window that appears.

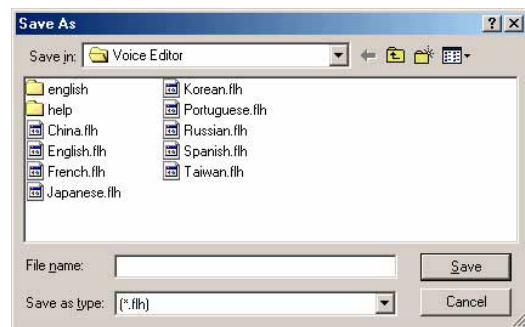
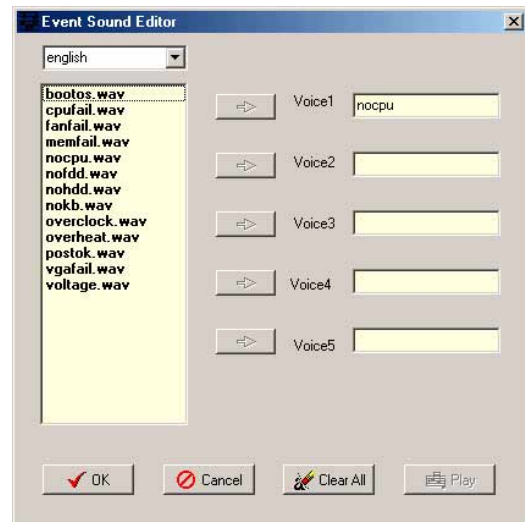

If you receive an error message telling you that the files exceed the total allowable size, do one or all of the following.

- Try to modify your messages to make them shorter
- Save the wave files at a lower quality
- Skip lesser used events like FDD Detection, IDE HDD Detection, etc.

## 5.3.6 Multi-Channel Audio Feature

The C-Media PCI Audio Driver and Applications are included in the Support CD that came with your motherboard package. Install these programs to enable the multi-channel audio feature.



You must use 4 or 6 channel speakers for this setup.

### Setting the C-Media Audio Mixer

1. Install the C-Media 6-channel PCI audio driver from the support CD.
2. After installation, the C-Media Mixer icon appears on the bottom right of the screen.



Mixer Icon

3. Click on the mixer icon to display the C-Media Audio Mixer.



Advanced Button

You may also launch the Mixer by clicking on the **Start** button on your Windows desktop, then select **Programs/PCI Audio Applications/Mixer/Audio Rack**.

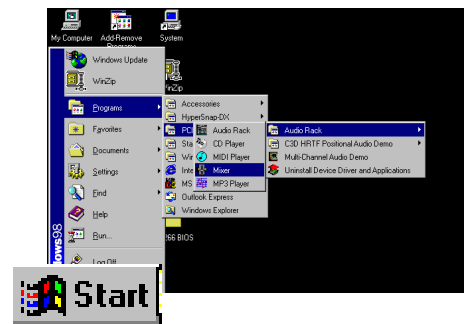

4. Click on the **Advanced** button on the Mixer to display the Speaker, Volume, Sound Effects, and Options menus.

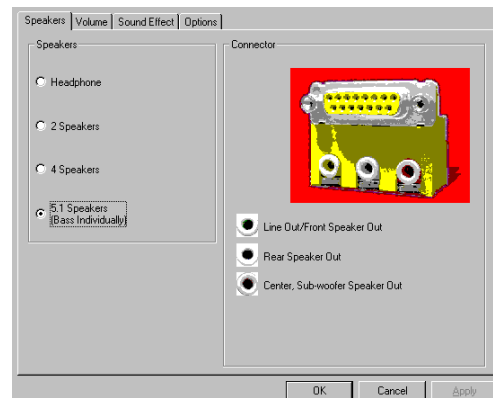

Make sure that the BCS1/BCS2 jumpers are set correctly before using the 6-channel audio feature. See page 2-22 for the settings.

## Running the C-Media Audio Demo Program

The C-Media audio demo program allows you to test and fine tune your speaker system. To launch the the multi-channel audio demo program, click on **Start** from your desktop, then select **PCI Audio Applications/ Multi-Channel Audio Demo**.

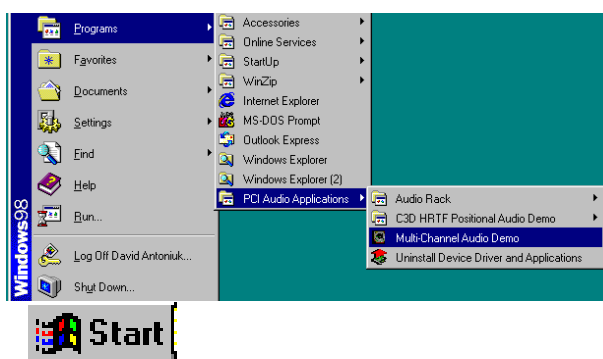

From the demo program interface, click on **Help** to display the instructions and hardware diagrams for configuring and testing your speaker system.

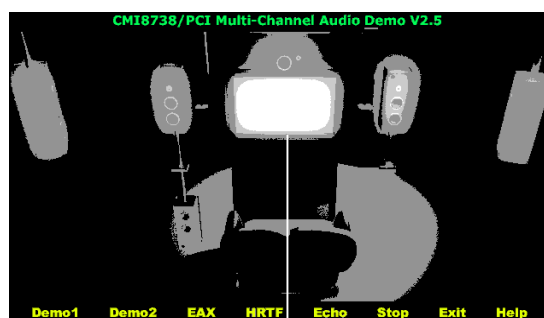

TV Box

To configure your speakers, launch the **Speaker Channel Configuration** menu by clicking on the TV Box on the program interface.

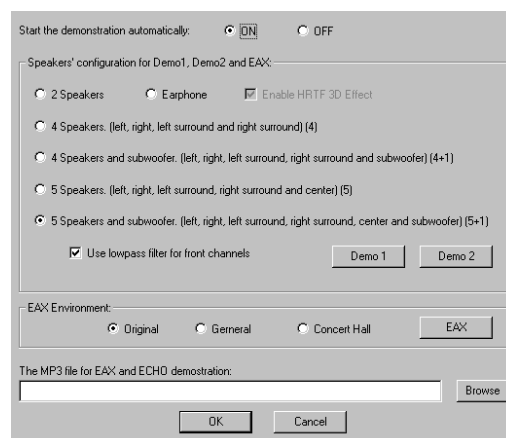

The functions of the Line Out (lime), Line In (blue), and Mic (pink) connectors on the rear panel change when you select the 6-channel audio configuration. Refer to the following table.

### Connector Settings and Functions

	Headphone/ 2-Speaker	4-Speaker	6-Speaker
Lime	Line Out/ Front Spkr Out	Line Out/ Front Spkr Out	Line Out/ Front Spkr Out
Light Blue	Line In	Rear Speaker Out	Rear Speaker Out
Pink	Mic In	Mic In	Center Speaker Out, Sub-woofer





# ***Index***

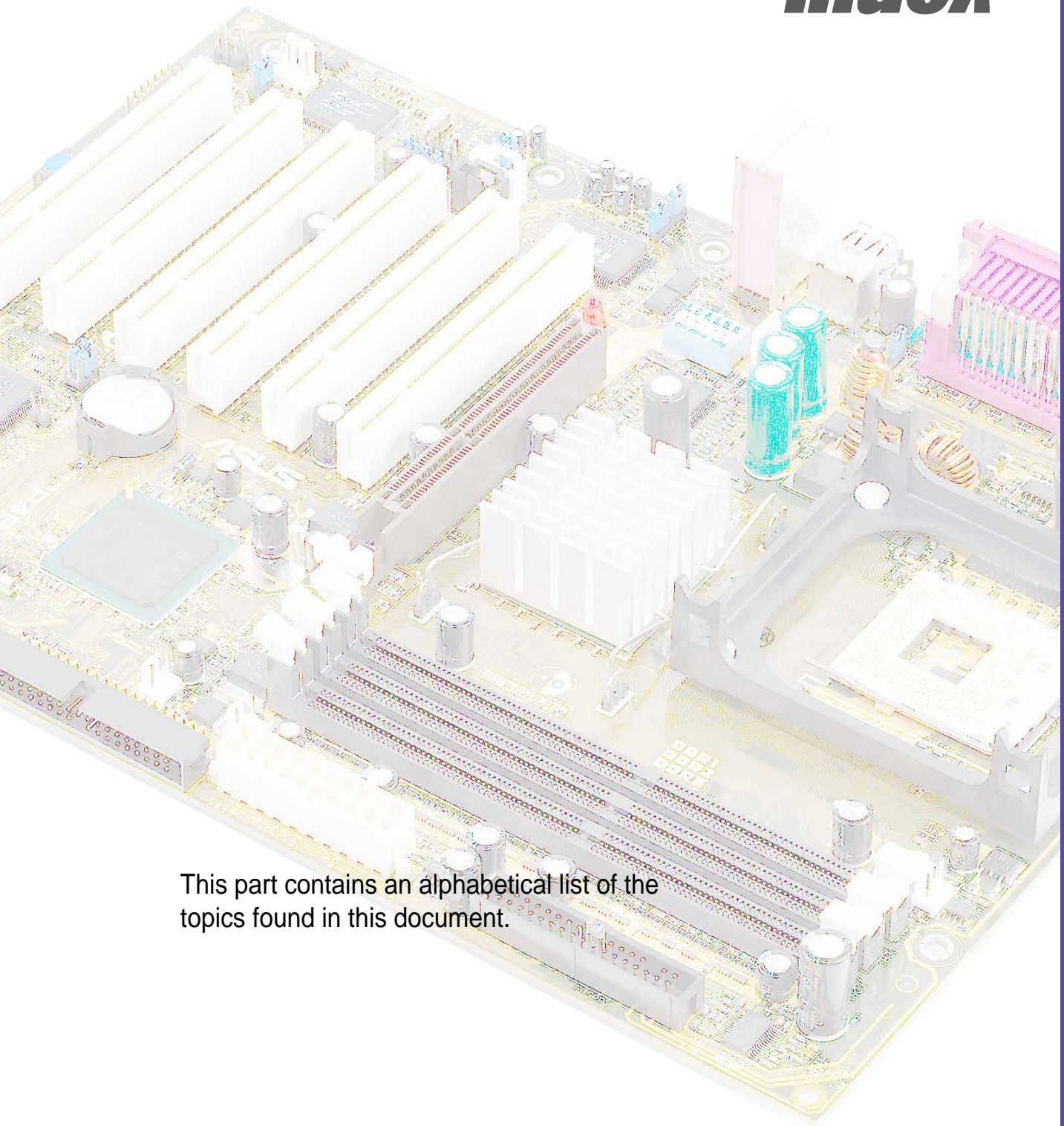

This part contains an alphabetical list of the topics found in this document.





## A

- Accelerated Graphics Port 2-15
- Acrobat Reader 5-4
- ASUS ASIC 1-9
- ASUS EZ Flash 4-1
- ASUS EZ Plug™ 1-3, 1-8, 2-27
- ASUS iPanel 2-32
- ASUS MyLogo2 1-3, 5-10
- ASUS PC Probe 5-12
- ASUS POST Reporter 1-3, 5-20
- ASUS Q-Fan 1-4, 4-32
- ASUS Update 5-9
- ATAPI CD-ROM 4-34
- Audio controller 1-9
- Automatic Power Up 4-31

## B

### BIOS

- Advanced Menu 4-17
- Boot Menu 4-34
- Boot Sequence 4-34
- Exit Menu 4-36
- Language 4-11
- Legend Bar 4-8
- Main Menu 4-10
- Menu Bar 4-8
- Power Menu 4-28
- Setup Defaults, loading 4-37
- Setup Program 4-7
- Sub-menu, launching 4-9
- Updating 4-1

- BIOS Beep Codes 3-1
- BIOS AFLASH utility 4-3
- Boot Device
  - selection 4-35
- Boot Up NumLock Status 4-16
- Boot Virus Detection 4-35

## C

- Central Processing Unit (CPU)
  - fan connector 2-9
  - installation 2-5
  - Level 1/Level 2 Cache 4-19
  - Speed 4-17
  - CPU socket 1-8, 2-5
- Chip Configuration 4-21
- Clear RTC RAM 2-23
- Concurrent PCI 1-4
- Connectors
  - ASUS EZ Plug™ 1-3, 1-8, 2-27
  - ASUS iPanel 2-32
  - ATX power 1-6, 2-27
  - chassis alarm 2-26
  - fan 2-28
  - floppy disk 1-6, 2-24
  - front panel audio 2-33
  - game/MIDI 2-30
  - IDE 1-9, 2-25
  - IDE LED 2-24
  - infrared module 2-30
  - internal audio 2-31
  - Line In 2-31
  - panel 2-33
  - power supply thermal 2-28
  - S/PDIF 2-32
  - SMBus 2-26
  - USB header 2-29
- CPU bus frequency 2-17
- CPU frequency 2-18

## D

- DDR SDRAM technology 2-10
- Digital audio interface 1-2
- DIMM
  - installing 2-11
  - removing 2-12
- DIMM sockets 1-8

DIP switches 1-8, 1-9, 2-16  
Double Data Rate (DDR)  
memory 1- 2

## **E**

Expansion card  
installation 2-13  
configuration 2-13  
Expansion slots 1-9, 2-13  
AGP 1-9, 2-15  
PCI 1-9, 2-15

## **F**

Flash EEPROM 1-9  
Floppy 3 Mode 4-10  
Floppy disk access control 4-24

## **H**

Hard Disk Drives (HDDs)  
CHS Capacity 4-14  
Cylinders 4-14  
Heads 4-14  
LBA Capacity 4-14  
Primary/Secondary Master 4-12  
Primary/Secondary Slave 4-12  
Sectors 4-14  
Types 4-12  
Hardware Monitor 4-32  
Heatsink  
installation 2-7

## **I**

IRQ assignments 2-14

## **J**

JumperFree mode 2-16  
Jumpers  
Audio CODEC 2-23  
Bass/Center setting 2-22  
Clear RTC 2-23  
DDR voltage 2-20

JumperFree 2-16  
keyboard power 2-19  
Line Out selector 2-22  
SMBus 2.0 2-21  
Speaker selector 2-21  
USB device wake-up 2-20  
VCORE over-voltage 2- 19

## **K**

Keyboard  
Auto-Repeat Delay 4-16  
Auto-Repeat Rate 4-16

## **L**

LEDs  
AGP warning 1-9, 2-3  
standby power 1-9, 2-3  
Legacy Diskette 4-10

## **M**

Motherboard  
major components 1-6  
IRQ Table 2-14  
layout 2-2  
placement 2-1  
screws 2-1  
Multi-sector transfers 4-14

## **O**

Operating system  
installation 5-1  
Overclocking features 1-4

## **P**

Parallel Port 1-10, 4-24  
Modes 4-25  
Password  
Supervisor 4-11  
User 4-11  
PCI Configuration 4-26  
PCI Latency Timer 4-26

PCI/VGA Palette Snoop 4-26  
PIO Mode 4-15  
Plug & Play O/S 4-35  
Power Management 4-28  
Power On Self Test 4-35  
PS/2 Keyboard Port 1-10  
PS/2 Mouse Port 1-10  
PS/2 Mouse  
    Function Control 4-20

## **R**

RTC RAM  
    clearing 2-23

## **S**

SDRAM  
    Active Precharge Delay 4-19  
    CAS Latency 4-21  
    Configuration 4-21  
    Idle Timer 4-22  
    RAS Precharge Delay 4-22  
    RAS to CAS Delay 4-21  
Serial Ports 1-10, 4-24  
SMART Monitoring 4-15  
Sony/Philips Digital Interface  
    (S/PDIF) 1-2, 2-32  
Super I/O controller 1-9  
Support CD 5-1  
    ASUS Update 5-9  
    DOS Utility menu 5-6  
    Drivers menu 5-5  
    E-Color 3Deep 5-17  
    Main menu 5-2  
    motherboard information 5-7  
    multi-channel audio 5-24  
    readme file 5-8  
    Software menu 5-3  
    Technical Support Form 5-8  
    Welcome screen 5-1  
Suspend Mode 4-29

System Controller  
    North Bridge 1-8  
    South Bridge 1-8  
System Date 4-10  
System memory  
    configurations 2-11  
System Time 4-10

## **U**

UART2 4-24  
Ultra DMA Mode 4-15  
USB Legacy Support 4-20  
USB ports 1-10

## **V**

Video memory cache  
    USWC 4-23  
    UC 4-23

## **Z**

ZIF socket 2-5

