

P/I-AP55T Mainboard User's Manual



Copyright

This Product, Including Any Software And Documentation, May Not, In Whole Or In Part, Be Copied, Photocopied, Translated Or Reduced To Any Electronic Or Machine-Readable Form Without Prior Written Consent From ASUSTek Computer Inc., Except For Copies Retained By The Purchaser For Backup Purposes.

No Warranty Or Representation, Either Expressed Or Implied, Is Made With Respect To This Documentation, Its Quality, Performance, Merchantability, Or Fitness For A Particular Purpose. As A Result, The Documentation Is Licensed "As Is," And The Licensee Will Assume The Entire Risk As To Its Quality And Performance. This Work's Content Is Copyrighted And Licensed To ASUSTek By Its Documentation Vendor And All Rights Are Reserved. ASUSTek Reserves The Right To Revise This Work And Any Accompanying Software And Documentation And To Make Changes In The Content Without Obligation To Notify Any Person Or Organization Of The Revision Or Change.

In No Event Will ASUSTek, Or Its Documentation Vendor, Be Liable For Direct, Indirect, Special, Incidental, Or Consequential Damages Arising Out Of The Use Or Inability To Use This Product Or Documentation Even If Advised Of The Possibility Of Such Damages. In Particular, ASUSTek Shall Not Have Liability For Any Hardware, Software, Or Data Stored Or Used With The Product, Including The Costs Of Repairing, Replacing, Or Recovering Such Hardware, Software Or Data.

Products Mentioned In This Manual Are Mentioned For Identification Purposes Only. Product Names Appearing In This Manual May Or May Not Be Registered Trademarks Or Copyrights Of Their Respective Companies.

© Copyright 1995

User's Manual Rev 1.2
Related Mainboard: P/I-AP55T P.C.B. Rev 1.3 and up
Related BIOS: #401A0-0109 or up (# appears in upper left-hand corner of screen at beginning of Power-On Boot-up)
Date: October 1995 ASUSTek Computer Inc.

Table of Contents

Chapter 1: Feature Guide	1-1
The P/I-AP55T Package	1-2
Main Features	1-3
Bundled Software	1-5
Static Electricity Precautions	1-5
Mainboard Layout	1-6
Using Your Mainboard	1-8
Hardware Settings	1-8
The System Configuration Record	1-10
System IRQs	1-11
BIOS-Supported Enhanced IDE Features	1-12
Power Conservation	1-14
Onboard VGA & Audio Features	1-15
SCSI BIOS Firmware & The SC-200 Controller Card	1-16
Chapter 2: Upgrade Guide	2-1
Installing Expansion Cards	2-1
Installation Procedure	2-1
Assigning System IRQs for Expansion Cards	2-3
Upgrading System Memory	2-5
Configuring System Memory	2-6
Installing SIMMs	2-8
Upgrading Video DRAM Memory	2-10
Installing IDE Hard Disks	2-11
Updating the Flash BIOS	2-13
Installing a Pentium Upgrade	2-14
Chapter 3: Software Guide	3-1
Award BIOS Setup	3-1
Standard CMOS Setup	3-3
BIOS Features Setup	3-8
Chipset Features Setup	3-12
Power Management Setup	3-16
PCI and PNP Configuration Setup	3-20
Load BIOS Defaults	3-23
Load Setup Defaults	3-24
Setting Supervisor & User Passwords	3-25

P/I-AP55T User's Manual

IDE HDD Auto Detection	3-26
Save And Exit Setup	3-28
Exit Without Saving	3-28
NCR SCSI BIOS & Drivers	3-29
Flash Memory Writer Utility	3-30
Chapter 4: Technical Summary	4-1
Jumper Setting Summary	4-1
Base Address Selector: JP1 & JP2	4-1
Bus & CPU External Clock Speed Selector: JP4, JP5 & JP6	4-2
PS/2 Mouse Port Selector: JP7	4-2
CPU Voltage Selector: JP8	4-3
Flash Eprom Read/Write Selector: JP9	4-3
Level 2 Cache Size: JP10	4-4
CPU Int. Clock External Multiple Selector: JP11 & JP12	4-4
RTC Clear CMOS Memory: JP13	4-5
Voltage Regulator Type Selector: JP15	4-5
Voltage Regulator Output Selector: JP16, JP17	4-6
Voltage Reg. Module Selector: JP19, JP20, JP21, JP22	4-6
COM2 Mode Selector: JP24 & JP25	4-7
Memory Subsystem	4-7
Expansion Video DRAM Specifications:	4-7
External Connections	4-8
Controller Cables	4-12
Connecting A Power Supply	4-13
Onboard ATI mach64 Information	4-14
The PCI-SC200 SCSI Interface Card	4-15
Setting Up the PCI-SC200	4-16
SCSI ID Numbers	4-19

Feature Guide

This manual explains how to use this system mainboard and install upgrades. It has an overview of the design and features of the board and provides useful information if you want to change the configuration of the board, or a system it is installed in.

How The Manual Is Organized

This manual is divided into four chapters:

Feature Guide – an overview of the board features

Upgrade Guide – upgrades for the board or system

Software Guide – the Setup Utility and other software & firmware

Technical Summary – technical reference

The manual assumes that your mainboard is already installed in a computer system, so we've organized the contents to reflect this. The first chapter introduces the mainboard's features and shows where things are on the board in case you want to install an upgrade.

Chapter 2 explains how to install upgrades.

Chapter 3 explains the Award BIOS Setup Utility, SCSI BIOS and the Flash Memory Writer BIOS update utility.

Chapter 4 lists settings and specifications and explains the optional SCSI interface card.

Since we are assuming that your mainboard is already installed in a system, it was most likely set up by your system dealer according to the design specifications of your computer. This could mean that your mainboard's current settings are not the same as the defaults shown in this manual. Your system manual may have additional information on how the mainboard should be set up.

If you want to change the existing configuration, consult all of your system documentation. Also be certain that opening up and working on the system yourself won't violate your system warranty. Most system vendors do allow you to open the system to install expansion cards or additional peripheral equipment.

This manual provides all the information you need to upgrade or change the setup of the board. If you don't feel confident of your ability to work on the computer yourself, ask your dealer or a qualified technician to do it for you.

The P/I-AP55T Package

Your mainboard package comes with the following:

- The mainboard
- 1 IDE cable, 1 Floppy Disk Drive controller cable
- External audio port module
- Floppy disks with support, driver and utility software
- This manual and a Video/Audio software manual
- Optional "riser" slot card with 32-bit PCI slots and 16-bit ISA slots which installs in the slot on mainboard. (Number of slots varies depending on which version you receive.)

If you purchased your mainboard as an upgrade, make sure all of the items listed are present and undamaged. If you discover a problem, contact your vendor immediately and inform them.

If the mainboard came installed in a system, you should have the support floppy disks. In this case, the drivers needed for your system may already be installed on the system hard disk drive. If not, you should install the ones you need. There is more information about how to do this in the Video/Audio manual.

Main Features

The P/I-AP55T has many performance and system features integrated onto the mainboard, including the following:

- Supports 75, 90, 100, 120, 133, 150 or 166MHz Pentium CPUs in a ZIF Socket 5 or 7. Pentium P55CT CPUs require the ZIF Socket 7 and Header 7 VRM sockets.
- Intel Triton chipset
- Uses 72-pin SIMM modules of 4, 8, 16, or 32MB in configurations up to 128MB using either Fast Page Mode or Extended Data Output (EDO) DRAM.
- Write-back "Level 2" external static RAM cache. The cache uses 256KB or 512KB of Pipeline Burst SRAM.
- 16-bit ISA and 32-bit Bus Master-capable PCI expansion slots on a riser slot card that installs in the on-board slot.
- On-board I/O ports: 2 serial ports, 16550 Fast UART compatible; 1 parallel port with EPP and ECP capabilities; all configurable as primary or secondary COM and LPT ports; the second UART can support an optional IrDA-compatible infrared port module attached to the onboard connector, instead of COM2; the floppy disk drive controller supports drives up to 2.88MB.
- Onboard Enhanced VGA graphics accelerator which supports multiple resolutions and both High and True color using an ATI Mach64 64-bit video display chip or with 1MB of DRAM video memory, optionally upgradable to 2MB. Software drivers and utilities provided are explained in accompanying Video/Audio manual.

- Onboard Creative Technology Vibra 16S sound card with external port module provides 16-bit SoundBlaster audio and onboard sound connections for several CD-ROM drives. External module has Microphone, Line-in, Speaker and Game ports and volume control. Software drivers and utilities provided are explained in accompanying Video/Audio manual.
- Onboard PCI Bus Master IDE controller with two connectors supports four IDE devices in two channels, faster data transfer rates and supports Enhanced IDE devices such as Tape Backup and CD-ROM drives. The controller supports PIO Modes 3 and 4 at a maximum transfer rate of 17MB/second and Bus Master IDE DMA Mode 2 at maximum 22MB/second.
- BIOS support for Power management and "Plug and Play" features and Enhanced IDE, including support for up to four IDE hard disks or other IDE devices and hard disks larger than 528MB and up to 8.4GB. Auto detection of installed IDE hard disk drives via a utility built into the BIOS.
- Onboard NCR SCSI BIOS firmware supports the optional PCI SC-200 SCSI controller card to connect up to seven internal or external SCSI devices.
- Onboard multi-year battery support to maintain system configuration information.
- Support floppy disks with utility and driver software. Additional Video/Audio manual.

Bundled Software

This mainboard comes with a variety of support software. The BIOS Support Disk has a readme file on it with the latest information on upgrading the BIOS, as explained in Chapter 3 of this manual. The Video/Audio manual that comes with this mainboard explains how to install and use the software for the VGA and audio features. The software includes:

- PFlash Memory Writer — updates the system BIOS with a new BIOS file.
- ATI Video Display Drivers & Utilities
- Creative Technologies Vibra 16S Utilities

Static Electricity Precautions

Under the right conditions, static electricity will build up. If you touch the mainboard or other sensitive components, the build-up will discharge into the components and circuitry. This is referred to as “electrostatic discharge” and computer components are sensitive to damage from it. They can be damaged, or even destroyed if the discharge is powerful enough. Static build-up is most likely to occur in dryer and cooler conditions, but it is always important to be cautious.

To protect the mainboard and other components against damage from static electric discharge, you should follow some basic precautions whenever you handle them:

1. Use a grounding wrist strap. The strap will have an 'alligator' clip at the end of a shielded wire lead. Clip it to a grounded object. Any static electricity will then harmlessly discharge through the strap. Put on and connect the strap *before* you handle the components.
2. Use an anti-static pad. Put any components on the pad whenever you work on them outside the computer. If you don't have a pad, put the components on the anti-static bag they came in.

Both the wrist strap and pad are inexpensive and are generally available from computer supply companies.

Mainboard Layout

The diagram on the next page shows the location of important components on the mainboard.

- | | |
|-------------------------------------|----------------------------------|
| 1. Enhanced VGA Monitor Port | 10. SIMM DRAM sockets |
| 2. LPT1 Parallel Port | 11. Video memory upgrade sockets |
| 3. COM2 Serial Port | 12. VGA Feature Connector |
| 4. COM1 Serial Port | 13. Wave Table option connector |
| 5. PS/2 (L) & Keyboard ports (R) | 14. Floppy Controller connector |
| 6. Power Supply Connector | 15. PCI Enhanced IDE connectors |
| 7. External Audio Module connector | 16. External Features connector |
| 8. Slot for PCI/ISA Slot Riser Card | 17. CPU in ZIF Socket |
| 9. CD-ROM drive audio connectors | 18. Header 7 VRM socket |

Feature Guide

1

P/I-AP55T Layout

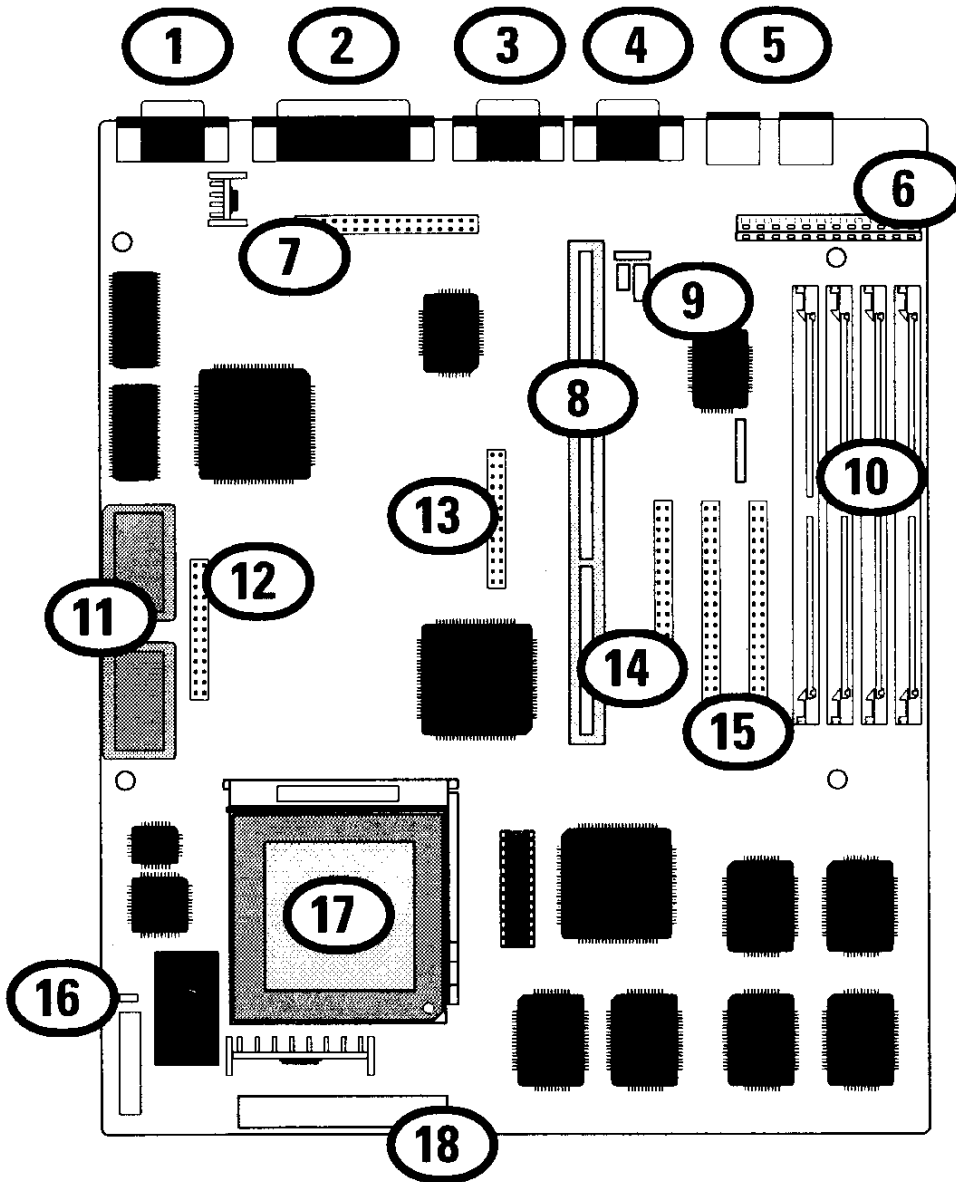

Using Your Mainboard

In addition to the operating instructions in your system manual, there are a few additional things specific to the mainboard you will need to know. These have to do with the hardware settings on the mainboard and the system configuration record.

Hardware Settings

There are a number of hardware settings on the board. They specify configuration options for various features. The settings are made using something called a 'jumper'. A jumper is a set of two or more metal pins in a plastic base attached to the mainboard. A plastic jumper 'cap' with a metal plate inside fits over two pins to create an electrical contact between them. The contact establishes a hardware setting.

Some jumpers have two pins, others have three or more. The jumpers are sometimes combined into sets called jumper 'blocks', where all the jumpers in the block must be set together to establish a hardware setting. The next figures show how this looks.

Jumpers and caps

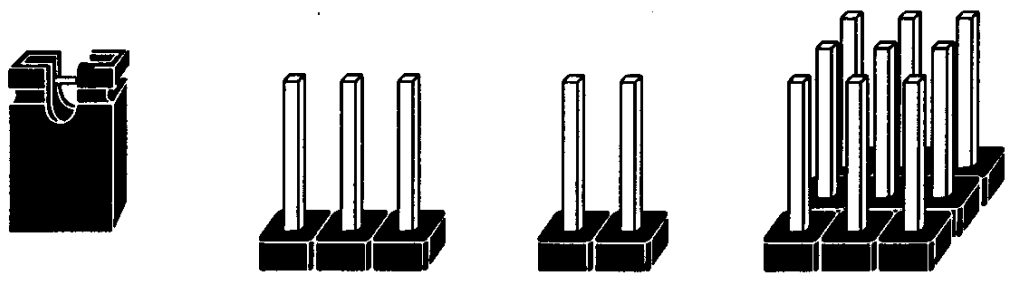

Jumper cap 3-pin jumper 2-pin jumper Jumper block

Setting options for most jumpers are printed on the board in a stylized bird's-eye view, with which pins to connect for each setting marked by a bar connecting two pins. For example, if a jumper has three pins, connecting, or 'shorting', the first and second pins creates one setting and shorting the second and third pins creates another. The same type of diagrams are used in this manual. The jumpers are always shown from the same point of view as shown in the whole-board diagram in this chapter. The next figures show what the manual diagrams look like and what they represent.

Jumper diagrams

Jumpers are shown like this

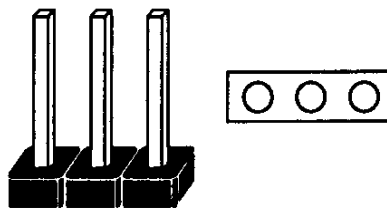
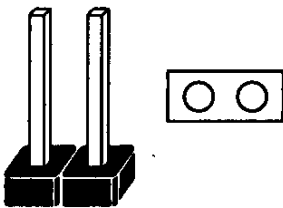

Jumper caps like this

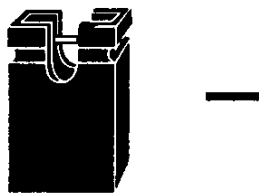

Jumper settings like this

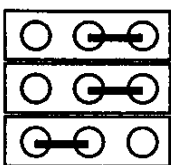
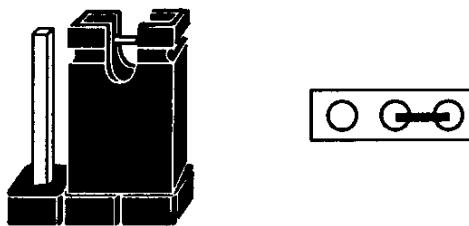

Jumpers in a 'block'



Some jumpers are oriented vertically; if the pin position needs to be shown, Pin 1 is marked.

The System Configuration Record

All personal computers use a BIOS (Basic Input Output System) as the basic software that tells the computer how to function. In order for the BIOS to function, there has to be a record of the computer's hardware and configuration settings for it to refer to. This record is created by using a software program permanently stored in the BIOS ROM chip on the mainboard. The program is called the BIOS Setup Utility.

The system configuration record the utility creates is also stored on the mainboard. Unlike the utility program, the record is not recorded permanently. The memory it gets stored in must be maintained by battery power when the computer is turned off. If battery support fails, the record will be lost and you will have to recreate it.

When you buy your computer, the system configuration record will already be set. The settings will be optimized for your computer hardware and may vary from the basic defaults. You should run the Setup Utility when you first use your computer. Write down the settings. The Setup Utility is explained in Chapter 3.

Important:

In some circumstances it is possible the configuration record may be corrupted or lost. If this happens, your computer will not work properly the next time you turn it on. This is not a serious problem. To fix it, run the Setup Utility and re-enter your configuration from your written record. When you restart the computer, it will work normally.

System IRQs

Later in the manual you'll see something called an "IRQ" mentioned several times. If you're not familiar with these, this is a short explanation of what they are and why you may need to know about them if you upgrade your system.

An IRQ, or interrupt request, is the process whereby an input or output device tells the CPU to temporarily interrupt whatever it is doing and immediately process something from the source of the interrupt. When finished the CPU goes back to what it was already processing. This happens very quickly. There are 16 IRQs, IRQ 0 through IRQ 15, some of which are already in use by basic components of the system. Devices that need an IRQ line to operate sometimes must have the exclusive use of that line.

Many expansion cards require the use of an IRQ line to operate, for example, network interface cards and sound cards. When you install a card that uses an IRQ, it will have a default IRQ setting that you might need to change if that IRQ is already in use and cannot be shared. There are different ways of setting an IRQ assignment, with jumpers being the most common.

The ISA and PCI buses all use the same set of system IRQs. On this mainboard the PCI-Bus Primary IDE channel uses IRQ14 and the Secondary channel uses IRQ15. For the PCI bus there is an additional consideration. On the PCI bus, you must assign an IRQ to the PCI slot you will install an IRQ-using card in. There are two methods of generating an IRQ on the PCI bus, level-triggering (level-sensitive) and edge-triggering. Most PCI expansion cards use the level-triggered design. A few cards may use the edge-triggered design instead. The BIOS PCI Slot Configuration therefore provides the means to set the IRQ assignment for a PCI slot for either method. This is explained in detail in Chapter 3.

BIOS-Supported Enhanced IDE Features

The BIOS has several feature enhancements for IDE hard disk drives and support for other IDE devices.

The original IDE implementation was limited to two hard disk drives with relatively slower data transfer rates. While this solution is simple and reliable, it has some limitations that have become more significant as the performance level of other system components and overall system performance have increased dramatically with the advent of new microprocessor, expansion bus and operating system technologies.

In response to these demands, the IDE specification has been updated to increase its capabilities and provide improved performance. Together these are referred to as 'Enhanced IDE'. Enhanced IDE features comprise the following:

- Support for IDE hard disk drives larger than 528MB.
- Support for IDE devices other than hard disk drives, including IDE Tape Backup and CD-ROM drives.
- Support for two IDE channels with two devices per channel, allowing the use of four IDE devices in one system.
- Support for faster data transfer rates, particularly with IDE controllers that use a PCI local bus interface.

This mainboard supports the use of these features, which work with the onboard PCI IDE controller that includes two connectors built onto the mainboard. With this controller you can use one or both connectors to connect up to four IDE devices to the system. If you want to use the second IDE channel, you must enable it in the Chip-set Features Setup section of the BIOS Setup utility.

Large IDE Hard Disks

For IDE hard disk drives, the BIOS provides three modes to support both normal IDE hard disks and also drives larger than 528MB:

Normal – for IDE drives smaller than 528MB

Large – for drives larger than 528MB that do not use LBA. These can only be used with the MS-DOS operating system.

LBA – for drives larger than 528MB and up to 8.4 GB (GigaBytes) that use Logic Block Addressing mode.

Other IDE Devices

Enhanced IDE allows the use of IDE devices other than hard disks. Two devices that previously required non-standard or adapted interfaces and are now available as standard IDE devices are Tape Backup and CD-ROM drives. These will now be able to take advantage of the ease of installation, lower cost and in some cases superior performance of Enhanced IDE, putting an end to the system configuration complications created by their earlier interfaces.

To use IDE devices other than hard disks with this mainboard you may need to install a device driver in your system software configuration. Refer to the documentation that comes with any device you will install for instructions about this and any other installation requirements.



P/I-AP55T User's Manual

Dual IDE Channel Support

With the onboard IDE controller you can connect up to four IDE peripheral devices to your system. With Enhanced IDE you can connect two devices to each connector. All devices are categorized the same way IDE hard disks have been in the past, with one device set as the "Master" device and the second as the "Slave" device. These two channels are called the "Primary" and the "Secondary" channel. The Primary channel uses IRQ14, the Secondary, IRQ15. If you are not using the Secondary channel, you can leave it disabled in the BIOS Setup utility. This will leave IRQ15 available for other use.

Faster Data Transfer

Enhanced IDE includes a scheme to support a significant increase in the rate of data transfer from the IDE device to the rest of the system compared to the previous standard. One aspect of this scheme is support for Mode 3 and 4 timing. If you use both the onboard controller and hard disks that support it you can increase the data transfer rate up to as much as 17MB per second.

Power Conservation

This mainboard incorporates power conservation technology which you can set up in the BIOS Setup Utility in the Power Management Setup section. The features include hard disk and video controls to reduce system power consumption. For more information, see the section on Power Management Setup in Chapter 3.



Onboard VGA & Audio Features

The onboard VGA display and audio features come with extensive software drivers and utilities. The other manual in the mainboard package explains how to install and use the software for these features. There is information on the hardware setup for these features in Chapter 4 of this manual.

VGA Hardware & Software

The onboard VGA display is capable of displaying multiple resolutions and color depths (numbers of colors) at a variety of refresh rates. Some combinations of resolution, color depth and refresh rate require an optional 1MB video DRAM upgrade. There is also a standard VGA pass-through connector on the mainboard.

The display drivers and utilities provided support Microsoft Windows and Windows NT, as well as OS/2 and several popular DOS applications.

Audio Hardware & Software

The onboard Vibra 16S audio from Creative Technologies Inc. is a 16-bit sound card integrated onto the mainboard. The external ports for the card are mounted on a module that installs in an empty expansion slot opening in the system case. Sound connectors for several CD-ROM drives, a connector for the port module and a connector for a Wave Table option are on the mainboard.

There are several Windows and DOS utilities for the audio feature. The Video/Audio manual that comes with this mainboard explains how to install and use them.

SCSI BIOS Firmware & The Optional SC-200 Controller Card

This mainboard has onboard NCR SCSI firmware recorded in the BIOS flash ROM chip that supports the NCR 53C810 PCI Fast SCSI-2 controller. There is an optional SCSI controller card, the SC-200 that uses this firmware. The NCR SCSI controller is a full 32-bit PCI DMA bus master and supports the ASPI and CAM standards.

You can connect a chain of up to seven devices to the SCSI interface. The SC-200 SCSI interface card provides both internal and external connectors. There are details on this card and how to connect SCSI devices to it at the end of Chapter 4.

Two floppy disks with support drivers come with the SC-200 card. There is detailed information about the drivers in "ReadMe" files on the disks. There is more information about these disks in the section on "SCSI BIOS & Drivers" in Chapter 3.

Upgrade Guide

This section explains how to install options on your mainboard. It covers the most likely and technically accessible upgrades you might want to do, including installing expansion cards, adding system or video memory, installing IDE devices and upgrading the CPU.

Installing upgrades will either improve the performance of your computer, or add some additional capabilities to it. You can install upgrades yourself, or have your dealer or a qualified computer service technician do it for you.

Installing Expansion Cards

There many ISA and PCI expansion cards you can install in your system to expand its capabilities. Any card you get will come with instructions on how to configure and install it. For your reference, we have included a brief description here of how to install a card in your system case. This is followed by an explanation of this mainboard's requirements for installing expansion cards that use an interrupt request line (IRQ). Please review the IRQ information carefully if you are installing this type of card. If you're more familiar with this topic, there is a chart-based synopsis of the required procedures.

Installation Procedure

Expansion cards often require pre-installation configuration and sometimes post-installation software setup. Check your card documentation for instructions on this. Once you have configured an expansion card you want to install, the installation procedure is fairly simple. Your system manual should have instructions for installing expansion cards specific to the design of your system case. The procedure here covers the basics for your reference.

Before you start, always make sure the computer is turned off. You should also make sure to observe standard static electricity discharge precautions. You can damage your expansion card, the mainboard, or both by not being careful about this.

The basic procedure for installing expansion cards is the same for both ISA and PCI cards.

The basic procedure is as follows:

1. Open the system case to gain access to the expansion slots.
2. Remove the slot-cover corresponding to the slot you want plan to use. Put the slot-cover retaining screw aside and store the slot cover in case you need it later.
3. Remove the card from its protective packaging if you haven't already.
4. Align the card's slot connectors to the slot. Keep the card at a 90° angle to the slot riser card. Insert the card into the slot by pressing it in firmly . If there is a lot of resistance, make sure the slot connectors are lined up correctly. PCI cards require little pressure to insert.
5. Attach the card's mounting bracket to the case using the slot cover screw you put aside in Step 2.
6. Close the case, turn on the computer and check to see if the card is working properly as well as do any software set up required.

Assigning System IRQs for Expansion Cards

Cards for both the ISA and PCI buses may need to use IRQs. You must configure any IRQ assignments so that the system can know which IRQ is assigned to which card. IRQs must be assigned correctly, or the mainboard will not work properly.

As mentioned in Chapter 1, there are 16 IRQs. Some of them are already in use by standard parts of the system such as the keyboard or mouse. IRQs 5, 10 and 11 are not used by the mainboard and are available. IRQ 15 is also available if you disable the Secondary IDE channel.

IRQs are available to either bus. The two bus designs deal with IRQs differently, however. For PCI cards that use an IRQ, the BIOS will auto-assign an IRQ from the available IRQs when the slots are set to "Auto" in the BIOS Setup Utility. See the section on PCI And PNP Setup in Chapter 3. The BIOS will not auto-assign an IRQ for a PCI slot if there is no card installed in the slot and or the card does not use an IRQ.

For ISA cards there are two methods. A "Legacy" ISA card requires that an IRQ it will use be configured on the card hardware. "Plug and Play" ISA cards can use an ISA Configuration Utility to determine and assign an available IRQ.

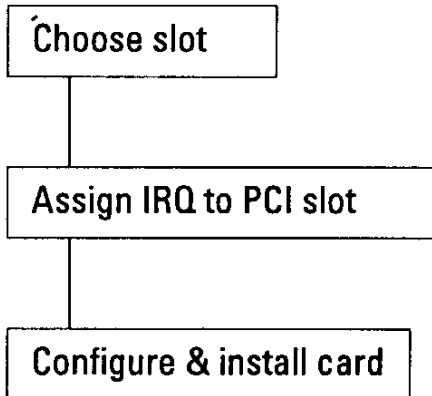
Installing Expansion Cards That Use An IRQ**Example PCI installation procedure:**

1. Choose a slot to use –
e.g. PCI Slot 1 - fixed INT A#
2. Make sure Slot 1 is set to the "Auto" setting
3. Configure the card you will install in PCI Slot 1 to use INT A and install it.

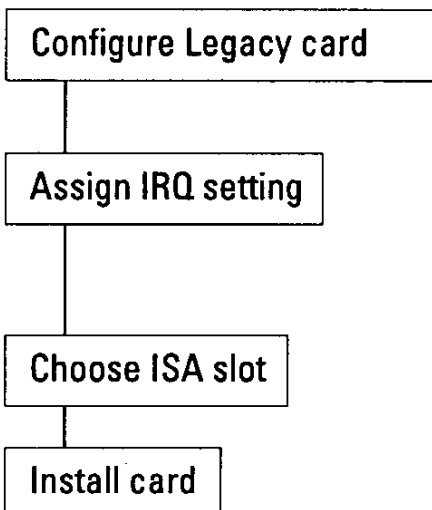
**Example ISA installation procedure:**

1. If it is a Legacy card, select the ISA IRQ it will use. If PNP card, skip this.
e.g. IRQ 5
2. If it is a Legacy card, set IRQ 5 as used by ISA in PCI and PNP Setup, or use ICU. If PNP card, skip this.
3. Choose an ISA slot to use -
e.g. ISA Slot 1
4. Install the card in ISA Slot 1. For a PNP ISA card, use an ICU to record the new configuration.

Upgrading System Memory

This section explains how to install system memory. There are instructions on how to configure and install memory and an explanation of the technical specifications required.

System DRAM is the main source of data for the CPU. Data remains stored in DRAM as long as the system is turned on, and is lost when you turn it off. The Level 2 cache memory is Static RAM (SRAM), which is faster than DRAM memory. When the CPU looks for data, it first searches the cache. If the information is not there, the search continues in the DRAM. With this design, the CPU looks in the fastest source of data first, which lets it operate as fast as possible.

The DRAM subsystem uses memory chips permanently mounted on small circuit boards to form "SIMMs" (Single In-line Memory Modules). The memory chips have a speed rating that is measured in nanoseconds (ns). This mainboard requires either Fast Page Mode (FPM) DRAM or Extended Data Output (EDO) DRAM with a speed of at least 60 or 70ns depending on the bus clock/CPU external clock speed setting.

This mainboard can use 72-pin SIMMs in four sizes from 4MB up to 32MB (megabytes). Depending on the combination of modules you use, you can install between 8MB and 128MB. The 32-bit modules used for this board come with memory chips on either one or both sides of the module.

Configuring System Memory

If you want to add system memory, you must use the configuration options and specifications shown in this section.

Memory Combinations

You can configure the system memory in a variety of ways, using different combinations of SIMM modules. Using the 4 SIMM sockets there are many configuration options.

The following chart shows the supported combinations.

The only restrictions are:

- You must use 2 sockets at a time, in sequence, i.e. SIMM 1 and SIMM 2, or all four sockets at once.
- Each pair of modules must be the same size and speed and can be either single or double-sided.
- Memory Specifications:

Module Size:

Single-sided SIMMs: 4MB, 16MB

Double-sided SIMMs: 8MB, 32MB

DRAM Type: Fast Page Mode or Extended Data Output

DRAM Speed: 70ns or faster for 75MHz, 90MHz and 120MHz Pentiums (50 or 60MHz external clock); 60ns for 100MHz and 133MHz Pentiums (66MHz external clock).

RAS access time [Trac]: 60ns - 70ns

CAS access time [Tcac]: 10ns - 25ns

Parity: Either parity or non-parity

Upgrade Guide

2

Memory Module Combinations

Bank 0 Sockets 1 & 2	Bank 1 Sockets 3 & 4	Total Memory Using Sockets 1 through 4
4MB x 2	None	8MB*
8MB x 2	None	16MB*
16MB x 2	None	32MB*
32MB x 2	None	64MB*
<i>* Note: The configurations above can use Bank 1 and leave Bank 0 empty instead</i>		
4MB x 2	4MB x 2	16MB
4MB x 2	8MB x 2	24MB
4MB x 2	16MB x 2	40MB
4MB x 2	32MB x 2	72MB
8MB x 2	4MB x 2	24MB
8MB x 2	8MB x 2	32MB
8MB x 2	16MB x 2	48MB
8MB x 2	32MB x 2	80MB
16MB x 2	4MB x 2	40MB
16MB x 2	8MB x 2	48MB
16MB x 2	16MB x 2	64MB
16MB x 2	32MB x 2	96MB
32MB x 2	4MB x 2	72MB
32MB x 2	8MB x 2	80MB
32MB x 2	16MB x 2	96MB
32MB x 2	32MB x 2	128MB

IMPORTANT: Do not use SIMM modules with more than 24 chips per module with this mainboard. Modules with more than 24 chips exceed the design specifications of the memory subsystem and will cause unreliable operation. DO NOT use 32 or 36-chip modules with this mainboard.

Installing SIMMs

To install SIMMs follow these instructions:

1. The modules will only insert in a socket in one orientation. An orientation cut-out will prevent you from inserting them the wrong way. See the figures at right.
2. Press the module edge connector into the socket at a moderate angle to the board. See the figures below.
3. Press the module forward onto the socket's vertical posts, so that the alignment pins at the top of each post go into the circular holes at each end of the module.
4. The module should click into place, as the retaining clips at each end of the socket snap behind the module to secure it.
5. Repeat this procedure for each module you install.

Installing a Memory Module

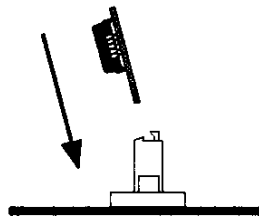

Insert the SIMM into the socket at an angle.

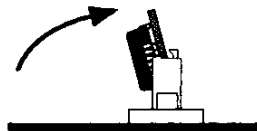

Press it forward onto the positioning pins.

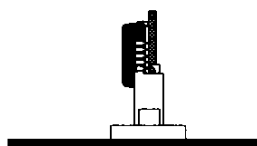

The retaining clips should fit over the edge and hold the SIMM in place.

Module Sockets & Orientation

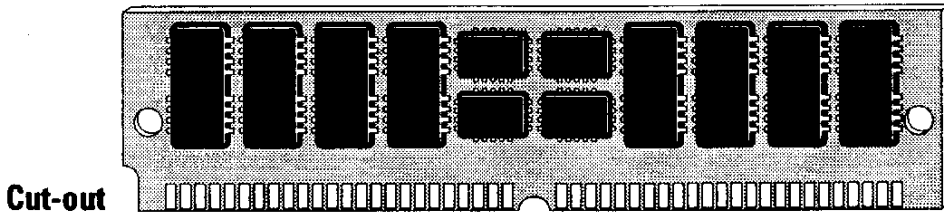

SIMMs have a cut-out at one end that matches an extension on one of the vertical posts of each socket.

Put orientation cut-out at this end.

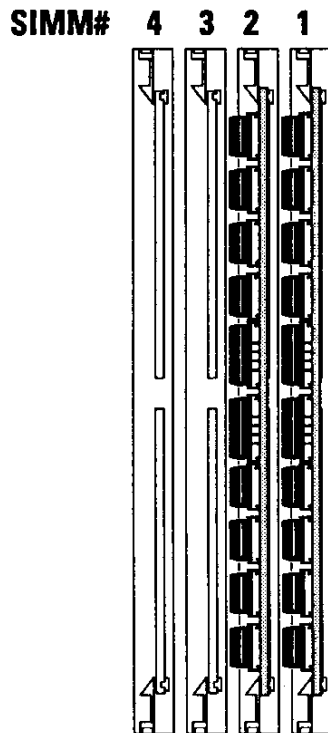

Install modules starting with the SIMM1 socket on the right-hand side. Modules may have chips on one or both sides.

Upgrading Video DRAM Memory

The mainboard comes with 1MB of video display DRAM mounted on it. In addition, there are two expansion sockets that allow you to expand the video display memory to 2MB.

To expand the video display memory, you must install two 512KB DRAM chips in the expansion sockets. To install the chips, observe static discharge precautions and do as follows:

1. Open your system case and find the video display memory expansion sockets, located near the monitor port.
2. Identify the Pin 1 corner of the socket. The Pin 1 corner is the upper left-hand corner from the point of view of the mainboard diagram on page 1-7 in Chapter 1.
3. Identify the Pin 1 corner of the DRAM chip. It should have a small dot indentation on the top of the chip at that corner.
4. Align the chip to the socket so that the Pin 1 corners match and press the chip into the socket.
5. Repeat steps 1 through 3 for the second socket and chip.
6. When you are done, reassemble your system and turn it on. Information about the video display appears first. Check to see that the memory total displayed is 2MB. If this is correct, the chips are correctly installed and the system is using the new display memory.

Please see Chapter 4 for information on the required specifications for the video display memory expansion DRAM chips.

Installing IDE Hard Disks

This section explains how to install IDE hard disk drives or other devices. You can connect up to four IDE devices to the onboard connectors. This section explains the information specific to this mainboard, not the basic procedure for how to install a hard disk in your system. Your system manual should have instructions specific to installing devices in your case.

Note: If you already have a SCSI hard disk installed and you install an IDE drive, the IDE drive must be the "Primary Master" drive.

Installing a Primary IDE Hard Disk

To install a first IDE hard disk do the following:

1. Follow the instructions in your computer system manual for installing a hard drive in an empty drive bay and connecting a power cable.
2. Connect one end of the IDE ribbon cable to the drive and the other to the Primary IDE connector on the mainboard with the colored edge of the cable at the Pin 1 side of both the drive and mainboard connectors.
3. Connect the drive LED connector to the IDE activity LED connector on the mainboard.
4. Reassemble and turn on the system and run the BIOS Setup Utility.
5. Use IDE HDD Auto Detection in the BIOS Setup utility to detect and enter the drive parameters for "Primary Master".

Note: If the device you install is not a hard disk drive, you should leave the Standard CMOS Setup entry for "Primary Master" set to "None".

Installing Additional IDE Devices

If you have space in your system case, you can install another IDE hard disk or other IDE device using the procedure on the previous page. Install the drive in an empty drive bay and connect the drive to the unused *middle* connector of the IDE ribbon cable. Note that a second IDE device on a channel must be set to function as a "slave" device, because the first IDE device functions as the "master" device. The device manual should tell you how to do this. Many IDE devices use jumpers to select this setting.

Once you have installed the device, you may need to use the BIOS Setup Utility again to configure and record the presence of the second device in the Standard CMOS Setup. The Primary channel is shown as "Primary Master" and "Primary Slave", the Secondary channel as "Secondary Master" and "Secondary Slave". If the device you installed is not a hard disk drive, you should leave the Standard CMOS Setup entry for its position set to "None".

See Chapter 3 for an explanation of how to use the hard disk auto-detection feature to automatically detect the parameters of IDE hard disks and other devices and enter them in the Standard CMOS Setup.

Updating the Flash BIOS

This mainboard has two BIOS ROM chip options. It can use either of two programmable 'flash' EPROM chips, 5-volt or 12-volt, either of which you can update when BIOS upgrades are available.

Jumper JP9 enables programming for the BIOS ROM chip. There are two settings. The default setting, which shorts pins 1&2, is for Write-Protect/Normal Read. The other setting, which shorts pins 2&3, is for Enable Programming.

When you finish programming, always set JP9 back to the default Write-Protect/Normal Read setting.

The following example illustrates this procedure.

BIOS Update Procedure

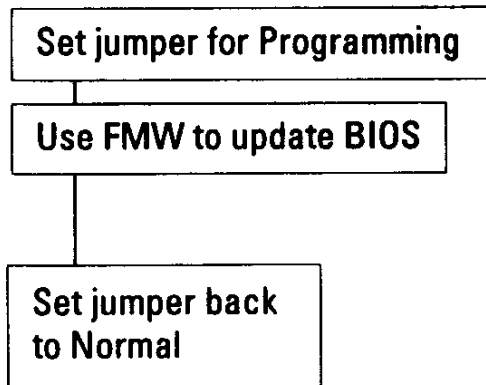

1. Set JP9 to the Programming Enabled setting.
2. Refer to Chapter 3 for instructions on using the Flash Memory Writer Utility to install a new BIOS file in the flash chip.
3. When you have successfully installed the new BIOS, set JP9 back to the Write Protect/Normal setting to disable programming.

Installing a Pentium Upgrade

If your mainboard has a "Socket 7" ZIF socket and Header 7 VRM (Voltage Regulator Module) socket, you can install a Pentium upgrade processor running at either 150MHz or 167MHz. The upgrade package will consist of the Pentium CPU and the required VRM.

To install an upgrade processor, follow the instructions that come with the upgrade. Remember to take careful precautions against static electric discharge. The basic procedure will be as follows:

1. Turn off and disconnect everything and open your system
2. Remove the existing CPU from the ZIF socket.
3. Follow the instructions that come with your upgrade kit for installing the upgrade components.
4. Reassemble the system and turn it on to make sure everything is working correctly.

As with any upgrade, if you are not comfortable doing the work yourself, you may want to have your system vendor, dealer or a service technician do the work for you. This is a particularly good idea where expensive and easily damaged components are concerned.

Software Guide

This chapter explains the Setup Utility for the Award BIOS, the SCSI BIOS and drivers, and the system BIOS flash memory update utility.

Award BIOS Setup

All computer mainboards of this type have a 'Setup' utility program stored in the BIOS ROM that is used to create a record of the system configuration and settings. If you received your mainboard installed as part of a system, the proper entries have probably already been made. If so, you might want to call up the Setup Utility, as described later, to take a look at them, and perhaps record them for future reference, particularly the hard disk specifications.

If you are installing the board or reconfiguring your system, you'll need to enter new setup information. This section explains how to use the program and make the appropriate entries.

The Setup Utility is stored in the BIOS ROM. When you turn the computer on, a screen message appears to give you an opportunity to call up the Setup Utility. It displays during the POST (Power On Self Test). If you don't have a chance to respond, reset the system by simultaneously typing the <Ctrl>, <Alt> and <Delete> keys, or by pushing the 'Reset' button on the system cabinet. You can also restart by turning the system OFF then ON.

This message will then reappear:

TO ENTER SETUP BEFORE BOOT PRESS CTRL - ALT - ESC OR DEL KEY

After you press the key the main program screen will appear, displaying the following choices.

Main Program Screen

ROM PCI/ISA BIOS (PI-5XTP4) CMOS SETUP UTILITY AWARD SOFTWARE, INC.	
STANDARD CMOS SETUP BIOS FEATURES SETUP CHIPSET FEATURES SETUP POWER MANAGEMENT SETUP PCI AND PNP SETUP LOAD BIOS DEFAULTS LOAD SETUP DEFAULTS	SUPERVISOR PASSWORD USER PASSWORD IDE HDD AUTO DETECTION SAVE & EXIT SETUP EXIT WITHOUT SAVING
ESC : Quit F10 : Save & Exit Setup	↑↓← : Select Item (SHIFT)F2 : Change Color
Time, Date, Hard Disk Type...	

This screen provides access to the utility's various functions.

Note: The 'BIOS Defaults' are minimized settings for troubleshooting. Use the 'Setup Defaults' to load optimized defaults for regular use. If you choose defaults at this level, it modifies all applicable settings.

A section at the bottom of the screen explains the controls for this screen. Use the arrow keys to move between items, <Shift>+<F2> to change the color scheme of the display and <Esc> to exit the utility. If you want to save changes, press the <F10> key to save the changes you made and exit the utility. Another section at the bottom of the screen displays a brief explanation of the item highlighted in the list.

Standard CMOS Setup

“STANDARD CMOS SETUP” records some basic system hardware information and sets the system clock and error handling. If your mainboard is already installed in a working system you will not need to do this. If the configuration record which gets stored in the CMOS memory on the board is lost or corrupted, or if you change your system hardware configuration, you will need to recreate the record. The configuration record can be lost or corrupted if the on-board battery that maintains it weakens or fails.

Standard CMOS Setup Screen

```

ROM PCI/ISA BIOS (PI-5XTP4)
STANDARD CMOS SETUP
AWARD SOFTWARE, INC.

Date (mm:dd:yy) : Tue, Feb 10 1995
Time (hh:mm:ss) : 10: 00: 00

HARD DISKS          TYPE      SIZE  CYLS  HEADS  PRECOMP  LANDZ  SECTOR  MODE
-----
Primary Master    : User      547   530   32     0   1059    63     LBA
Primary Slave    : None        0     0     0     0     0     0     -----
Secondary Master : None        0     0     0     0     0     0     -----
Secondary Slave  : None        0     0     0     0     0     0     -----

Drive A : 1.2M , 5.25 in.
Drive B : 1.44M, 3.5 in.

Video : EGA/VGA
Halt On : All Errors

Base Memory: 640K
Extended Memory: 7168K
Other Memory: 384K
-----
Total Memory: 8192K

ESC : Quit          ↑↓→← : Select Item    PU/PD/+/- : Modify
F1  : Help          (SHIFT)F2 : Change Color
    
```

“STANDARD CMOS SETUP” displays a screen with a list of entries. Follow the on-screen instructions to move around the screen. Instructions at the bottom of the screen list the controls for this screen. Use the arrow keys to move between fields, and the <Page Up> ('PU'), <Page Down> ('PD') or plus and minus keys to change the option shown in the selected field. Pressing <Shift>+<F2> changes the color scheme of the display, and <Esc> exits this level and returns to the main screen.

Modifiable fields appear in a different color. If you need information about what changes to make, press the <F1> key. The help menu will then give you information on the item highlighted. The display of available memory at the lower right-hand side of the screen functions automatically.

Date & Time

The first two lines on the screen are the date and time settings for the system clock.

Hard Drive Type

You must enter the specifications of all non-SCSI hard disk drives installed in your system. MFM, ESDI and IDE hard disks all need to have their specifications recorded here. The onboard PCI IDE connectors provide two channels, Primary and Secondary for connecting up to four IDE hard disks or other IDE devices, two to each channel. Only hard disks need to be entered here.

If you have one or more SCSI hard disks installed in your system, you do not need to enter their specifications here. SCSI drives operate using device drivers and are not supported directly by any current PC BIOS. If your mainboard has the SCSI controller card option, and you will use it, see the SCSI instructions that follow later in this section. If you have some other SCSI controller, follow the instructions that came with it on how to install any required SCSI driver.

There are four hard disks listed "Primary Master", "Primary Slave", "Secondary Master" and "Secondary Slave". For each IDE channel, the first device is the 'master' and the second device the 'slave'.

To enter the specifications for an MFM or ESDI hard disk drive, you must first select a 'type'. You can select the "User" option and enter the specifications yourself manually or there are 45 predefined drive specifications which you can look through to see if the specifications for your drive are assigned a type number. Do this by using the <Page Up> or <Page Down> key to change the option listed after the drive letter.

For an IDE hard drive, you should use the auto-detection utility described later to enter the drive specifications automatically. If you want to do this, leave the drive set to "None". You can enter the specifications yourself manually by using the User option if you want to.

There are six categories of information you must enter: "Cyls" (number of cylinders), "Heads" (number of read/write heads), "Precomp" (write precompensation), "LandZ" (landing zone), "Sector" (number of sectors) and "Mode". The "Size" entry is automatically determined by the other specifications. Your hard disk vendor's or system manufacturer's documentation should provide you with the drive specifications. If you have an IDE drive, unless your drive is already formatted with specifications different from those detected by the auto-detection utility, the easiest thing to do is use the auto-detection feature to enter the drive specifications.

Mode Setting For Hard Disk Drives Larger Than 528MB

The last of the specification entries, Mode, requires additional explanation. The Mode settings are for IDE hard disks only. You can ignore this item for MFM and ESDI drives. There are three entries you can select from in the Mode field, "Normal", "Large" and "LBA".

Set Mode to the Normal setting for IDE hard disk drives smaller than 528MB. Use the LBA setting for drives over 528MB that use Logical Block Addressing mode to allow larger IDE hard disks. The Large setting is for drives over 528MB that do not use the LBA mode. This type of drive can only be used with MS-DOS and is uncommon. The majority of IDE drives over 528MB use the LBA mode.

Note: Entering incorrect drive specifications will result in a hard disk drive functioning improperly or not at all.

Floppy Disk Drives

The next two lines record the types of floppy disk drive present. The options for drives A and B are:

360KB, 5.25 in.

1.2MB, 5.25 in.

720KB, 3.5 in.

1.44MB, 3.5 in.

2.88MB, 3.5 in.

None

Highlight the listing after each drive name and select the appropriate entry.



Video Display Types

“Video” refers to the type of video display card your system has. The options are:

EGA/VGA

Mono (for Hercules or MDA)

CGA 40

CGA 80

You should select the setting that matches your video display card. If you have a VGA or any higher resolution card, choose the EGA/VGA setting.

Error Handling

The last line “Halt On” controls whether the system stops in case of an error. The options are:

All Errors

No Errors

All, But Keyboard

All, But Diskette

All, But Disk/Key

For most purposes, we suggest that you leave the setting on the default, “All Errors”, unless you know why you want to use a different setting.

When you have made your selections, exit to the main program screen by pressing the <Esc> key.

BIOS Features Setup

"BIOS FEATURES SETUP" is a list of system configuration options. Some entries are defaults required by the mainboard's design. Others will improve your system's performance if enabled, or let you set up some system features according to your preference.

BIOS Features Setup Screen

ROM PCI/ISA BIOS (PI-5XTP4)			
BIOS FEATURES SETUP			
AWARD SOFTWARE INC.			
Virus Warning	: Disabled	Video BIOS Shadow	: Enabled
CPU Internal Cache	: Enabled	C8000-CBFFF Shadow	: Disabled
External Cache	: Enabled	CC000-CFFFF Shadow	: Disabled
Quick Power On Self Test	: Enabled	D0000-D3FFF Shadow	: Disabled
Boot Sequence	: C,A	D4000-D7FFF Shadow	: Disabled
Swap Floppy Drive	: Disabled	D8000-DBFFF Shadow	: Disabled
Boot Up Floppy seek	: Disabled	DC000-DFFFF Shadow	: Disabled
Boot Up NumLock Status	: On	E0000-E3FFF Shadow	: Disabled
Boot Up System Speed	: High	E4000-E7FFF Shadow	: Disabled
IDE HDD Block Mode	: Enabled	E8000-EBFFF Shadow	: Disabled
IDE 32-bit Transfer Mode	: Enabled	EC000-EFFFF Shadow	: Disabled
Typeomatic Rate Setting	: Disabled		
Typeomatic Rate (Chars/Sec)	: 6		
Typeomatic Delay (Msec)	: 250		
Security Option	: System		
IDE Second Channel Control	: Enabled		
		ESC : Quit	↑↓←→ : Select Item
		F1 : Help	PU/PD/+/- : Modify
		F5 : Old Values (SHIFT)	F2 : Color
		F6 : Load BIOS Defaults	
		F7 : Load Setup Defaults	

A section at the lower right of the screen explains how to navigate and make changes. The controls are the same as for the Standard CMOS Setup.

If you need information about what changes to make, highlight an entry and press the <F1> key. A pop-up help menu will display information about the highlighted item. Press the <F5> key to recall the last set of values saved for this page. Pressing the <F6> key loads the BIOS default values for this page and <F7> loads the Setup default values.

The following explains the options for each entry and indicates the default settings (Setup Defaults) for this screen.

Virus Protection

The "Virus Warning" default setting is "Disabled". This feature protects the boot sector and partition table of your hard disk. Any attempt to write to them will halt the system and cause a warning message to appear. If this happens, you can either allow the operation to continue or stop it and use an anti-virus utility on a virus-free bootable floppy disk to reboot and investigate your system.

Cache Control

The "CPU Internal Cache" and "External Cache" default settings are "Enabled". These settings enable CPU's 'Level 1' built-in cache and the 'Level 2' secondary cache. The BIOS Default settings will disable the L2 cache. Leave both enabled unless you are troubleshooting a problem.

Boot Up Features

The "Quick Power On Self Test" default setting is "Enabled". This speeds up the Power On Self Test (POST) by skipping some items that are normally checked during the full POST. If your system is functioning normally, you can use this feature to speed the boot up process.

The "Boot Sequence" default setting is "C:, A:"; the other option is "A:, C:". The setting determines where the computer looks first for an operating system, the hard disk or the floppy drive.

The "Swap Floppy Drive" default setting is "Disabled". When enabled, the BIOS will swap floppy drive assignments so that Drive A will function as Drive B: and Drive B: as Drive A: under DOS.

The "Boot Up Floppy Seek" default setting is "Disabled". When enabled, the BIOS will check if there is a 360KB floppy disk drive installed. Don't change this unless there is a 360KB drive installed.

The default **“Boot Up NumLock Status”** setting is **“On”**. When the computer boots, the numbers on the numeric keypad of an IBM-compatible extended keyboard will be active. If you turn this off the keypad cursor controls will be active.

· **“Boot Up System Speed”** sets the CPU speed at boot up. The default setting is **“High”**.

IDE Modes

The **“IDE HDD Block Mode”** default setting is **“Enabled”**. This feature enhances hard disk performance by making multi-sector transfers instead of one sector per transfer. Most IDE drives, except very early designs, can use this feature.

The **“IDE 32-bit Transfer Mode”** default setting is **“Enabled”**. This feature allows 32-bit data transfer between the system and the IDE hard disks if the hard disk controller supports 32-bit transfer. The onboard PCI IDE controller supports 32-bit transfer, so if you use it, you can enable this feature to improve performance.

Keyboard Interface

The **“Typematic Rate Setting”** default setting is **“Disabled”**. If enabled, you can set the typematic controls that follow.

The **“Typematic Rate (Char/Sec)”** controls the speed at which the system registers repeated keystrokes. The choices range from 6 to 30 characters per second (default is 6).

The **“Typematic Delay (Msec)”** controls the time between the display of the first and second characters. There are four delay rate choices: 250ms, 500ms, 750ms and 1000ms (default is 250ms).

Password Control

The "Security Option" controls the Password Setting in the main screen. The default setting is "System", uses the User Password feature every time you boot up. The other setting is "Setup". This will allow the system to boot, and use the Supervisor Password *only* to protect the Setup Utility settings from being tampered with. You create a password by using the Supervisor or User Password command from the main screen as explained later in this section.

IDE Second Channel Control

The "IDE Second Channel Control" default setting is "Enabled". If you do not want to use the second onboard Enhanced IDE channel, disable this. When the second channel is enabled, it uses IRQ 15, whether or not you connect anything to the onboard connector.

Shadow Controls

The default setting for the "Video BIOS Shadow" is "Enabled". This copies the video display card BIOS into system DRAM to improve performance.

The next ten lines, "C8000-CBFFF Shadow" to "EC000-EFFFF Shadow" are for shadowing other expansion card ROMs. The default setting for these areas is "Disabled". If you have other expansion cards with ROMs on them, you will need to know which addresses the ROMs use to shadow them specifically. When you shadow a ROM it reduces the memory available between 640KB and 1024KB by the amount used for shadowing.

After you have made your selections in BIOS Features Setup, press the <Esc> key to go back to the main screen. The next item is Chipset Features Setup.

Chipset Features Setup

This screen controls the settings for the mainboard's chip set. The controls for this screen are the same as for the previous screen.

Chipset Features Screen

ROM PCI/ISA BIOS (PI-5XTP4)					
CHIPSET FEATURES SETUP					
AWARD SOFTWARE INC.					
Auto Configuration	:	Enabled	Onboard IDE Timing	:	Fastest
DRAM Read Timing EDO/STD	:	x222/x333	Onboard FDC Controller	:	Enabled
DRAM Write Timing	:	x222	Onboard FDC Swap A & B	:	No Swap
RAS To CAS Delay	:	3T	Onboard Serial Port 1	:	COM1,3F8H
DRAM Leadoff Timing	:	7T	Onboard Serial Port 2	:	COM2,2F8H
PCI Concurrency	:	Enabled	Onboard Parallel Port	:	378H/IRQ7
PCI Streaming	:	Enabled	Parallel Port Mode	:	Normal
CPU to PCI Burst	:	Enabled	SMC ECP DMA Select	:	Disabled
16-bit I/O Recovery Time	:	3 BUSCLK	UART2 Use Infrared	:	Disabled
8-bit I/O Recovery Time	:	3 BUSCLK			
Video BIOS Cacheable	:	Disabled			
Memory Hole At 15M-16M	:	Disabled			
		ESC : Quit	↑↓←→ : Select Item		
		F1 : Help	PU/PD/+/- : Modify		
		F5 : Old Values (SHIFT)	F2 : Color		
		F6 : Load BIOS Defaults			
		F7 : Load Setup Defaults			

The first ten lines after Auto Configuration are optimal settings for this mainboard that are defined by the Auto Configuration feature, which configures the settings based on the CPU clock speed. You should not change them unless you know what you are doing.

You can enable the Memory Hole feature if you need it for an expansion card you are installing. Refer to the card documentation for instructions regarding this feature.

Controller Settings

The default setting for **"Onboard IDE Timing"** is **"Fastest"**, which provides optimum performance for Enhanced IDE Modes 3 and 4. If the hard disk drive(s) installed in your system can not use the fastest timing, you should change the setting to **"Fast"**. If you have any hard disk installed that does not support Mode 3 and 4 timing, you should set this line to the **"Standard"** setting.

Note: This line also has a **"Disable"** setting. If you disable this line, it disables the onboard IDE controller. Make sure you do this if you want to use an IDE controller other than the one on the mainboard.

The default setting for the **"Onboard FDC Controller"** is **"Enabled"**. This setting allows you to connect your floppy disk drives to the onboard **"Floppy"** connector instead of a separate controller card. Choose the **"Disabled"** setting if you want to use a separate controller card.

The default setting for the **"Onboard FDC Swap A: B:"** is **"No Swap"**. If you want to reverse the drive letter assignments of your floppy disk drives you can set this to **"Swap AB"** and the swap will be controlled in hardware. This works separately from the BIOS Features floppy disk swap feature. It is functionally the same as physically changing the floppy disk drive cable connector positions.

Serial Ports

The "Onboard Serial Port 1" and "Onboard Serial Port 2" lines control the assignments for the mainboard's two onboard serial connectors. They can be assigned as follows:

COM1, 3F8H (Onboard Serial Port 1 default)

COM2, 2F8H (Onboard Serial Port 2 default)

COM3, 3E8H

COM4, 2E8H

Disabled turns off the onboard ports

Parallel Port

The options for "Onboard Parallel Port" are:

3BCH/IRQ7

378H/IRQ7 Default setting

278H/IRQ5

Disabled

This line controls the onboard parallel port and connector, setting the port address and IRQ assignment or disabling the port. It should be unnecessary to change the default setting.

Parallel Port Mode

The options for "Parallel Port Mode" are:

Normal Default setting

EPP

ECP default DMA 3

ECP&EPP

If you want to use one of the parallel port enhancements listed, set this line for the enhanced mode your peripheral supports. "ECP" automatically sets the "ECP DMA Select" line to "3", where it is otherwise set to "Disabled", and cannot be set independently.

ECP DMA Select

If you select the ECP parallel port feature on the previous line, the BIOS will auto-select DMA channel 3 for the “ECP DMA Select” line. This line does not appear unless the ECP feature is selected.

UART2 Use Infrared

The default setting for the “UART2 Use Infrared ” is “Disabled”. The default setting leaves the second serial port UART set to support the Serial Port 2 connector. The “Enabled” setting activates the onboard infrared IrDA feature and sets the second serial UART to support the infrared module connector on the mainboard instead. Choose this if you want to connect an infrared control module to the mainboard. The onboard COM2 serial port will no longer work if you enable the infrared feature.

When you are done with this section, press the <Esc> key to go back to the main screen.

Power Management Setup

Power Management Setup controls the mainboard's "green" features. The features shut down the video display and hard disk to save energy.

The Power Management Setup Screen

ROM PCI/ISA BIOS (PI-5XTP4)			
POWER MANAGEMENT SETUP			
AWARD SOFTWARE INC.			
Power Management	: User Define	IRQ3 (COM 2)	: Disable
Video Off Option	: Susp,Stdbby->Off	IRQ4 (COM 1)	: Enable
Video Off Method	: V/H SYNC+Blank	IRQ5 (LPT 2)	: Enable
Suspend Switch	: Enable	IRQ6 (Floppy Disk)	: Enable
Doze Speed (div by)	: 8	IRQ7 (LPT 1)	: Enable
Stdbby Speed(div by)	: 32	IRQ8 (RTC Alarm)	: Disable
** PM Timers **		IRQ9 (IRQ2 Redir)	: Enable
HDD Power Down	: Disable	IRQ10 (Reserved)	: Enable
Doze Mode	: Disable	IRQ11 (Reserved)	: Enable
Standby Mode	: Disable	IRQ12 (PS/2 Mouse)	: Enable
Suspend Mode	: Disable	IRQ13 (Coprocessor)	: Enable
** PM Events **		IRQ14 (Hard Disk)	: Enable
IRQ3 (Wake-Up)	: Disable	IRQ15 (Reserved)	: Enable
IRQ4 (Wake-Up)	: Enable	ESC : Quit	↑↓→← : Select Item
IRQ8 (Wake-Up)	: Disable	F1 : Help	PU/PD/+/- : Modify
IRQ12 (Wake-Up)	: Enable	F5 : Old Values (SHIFT)	F2 : Color
		F6 : Load BIOS Defaults	
		F7 : Load Setup Defaults	

Power Management

"Power Management" is the master control for the power saving modes, Display Turn off and HDD Power Down that together form the hardware power conservation scheme. There are four settings:

- Max Saving** Sets the power conservation options to maximize power saving by putting the system into power saving mode after a brief period of system inactivity.

- Min Saving Another set of power saving assignments which activate each after a moderate period of system inactivity.
- Disable Turns off all power saving
- User Defined Allows you to set power saving options according to your requirements. (Default)

Max Saving

The "Max Saving" defaults are "1 Min" and "1 Min".

Min Saving

The "Min Saving" defaults are "20Min" and "1 Hour".

Video Off

The "Video Off Option" default is "Susp,Stby-> Off". This line defines when the video off features activate. The next line sets how.

The "Video Off Method" default is "V/H SYNC+Blank". The other options are "DPMS" and "Blank Only". When power management blanks the monitor screen, the default setting blanks the screen and turns off vertical and horizontal scanning. The DPMS (Display Power Management System) setting allows the BIOS to control the video display card if it has the DPMS feature. If you don't have a "Green" monitor, use the Blank Only option.

Note: "Screen Saver" software does not work with this feature. Screen savers are to prevent burning in a static image on the CRT while the monitor is on. A screen saver cannot display while the monitor is shut down to save both electricity and the screen.

Suspend Switch

The "Suspend Switch" default is "Enable". This enables the SMI connector on the mainboard. The SMI connector connects to the lead from a Suspend switch mounted on the system case.

Doze & Standby Speeds

The next two lines set the speed the CPU will operate at during each mode. The number indicates what the normal CPU speed is divided by.

PM Timers

The next lines control the time-out settings for the Power Management scheme. The features are "HDD Power Down", which puts the hard disk into its lowest power consumption mode, and the Doze, Standby and Suspend system inactivation modes.

The system automatically recovers from any power saving mode when there is system activity, as, for example, when you type any key, or when there is an IRQ wake-up event such as moving the mouse or a modem ring.

"HDD Power Down" shuts down any IDE hard disk drives in the system if they are not accessed for the specified period. The time settings range from "1 Min" to "20 Min", or "Disable".

HDD Power Down does not affect SCSI hard disks.

The "Doze Mode", "Standby Mode" and "Suspend Mode" lines set the period of time after which each of these modes activate. At 'Max Saving' they activate sequentially after one minute each, at 'Min Saving' after one hour.

PM Events

If there is activity on any of the IRQs listed in the left-hand group while the system is suspended, the system will wake up if that IRQ is Enabled. You can enable power management for IRQs 3-15 individually in the list at the right of the screen. The power management scheme will work on the enabled IRQs.

Note: Normally, a Microsoft serial mouse or compatible will use either COM1 (IRQ4) or COM2 (IRQ3) and a PS/2-type mouse will use IRQ12. If you know which IRQ your mouse is using, you can make sure the Wake-up Event for that IRQ is turned on here and the system will wake up when you move the mouse or click a button.

IRQ3 to IRQ15 Individual Settings

You can set IRQs 3-15 individually. Activity on any enabled IRQ will wake up the system.

When you are done here, press the <Esc> key to go back to the main screen.

PCI and PNP Configuration Setup

This screen configures the PCI Bus slots. All the slots use INTA#. If you install a card, you should set the card to INTA#.

PCI And PNP Configuration Setup Screen

```

ROM PCI/ISA BIOS (PI-5XTP4)
PCI AND PNP SETUP
AWARD SOFTWARE INC.

SLOT 1 (Top) IRQ : Auto
SLOT 2 IRQ      : Auto
SLOT 3 (Bottom) IRQ: Auto
PCI Latency Timer : 80 PCI Clock

DMA 1 Used By ISA : No/ICU
DMA 3 Used By ISA : No/ICU
DMA 5 Used By ISA : No/ICU

ISA MEM Block Base : No/ICU

IRQ 3 Used By ISA : No/ICU
IRQ 4 Used By ISA : No/ICU
IRQ 5 Used By ISA : No/ICU
IRQ 9 Used By ISA : No/ICU
IRQ 10 Used By ISA : No/ICU
IRQ 11 Used By ISA : No/ICU
IRQ 15 Used By ISA : No/ICU

ESC : Quit      ↑↓→← : Select Item
F1  : Help      PU/PD/+- : Modify
F5  : Old Values (SHIFT)F2 : Color
F6  : Load BIOS Defaults
F7  : Load Setup Defaults
    
```

The first four lines on the screen set how PCI slot IRQ use is determined. The default setting for each line is "Auto", which will use auto-routing to determine IRQ use. Use the options "14" or "14&15" if you install an Enhanced IDE controller card. A card with one channel should use the "14" setting and a two-channel card should use the "14&15" setting. Please note that if you use one or both of these IRQs here, they will not be available to the onboard PCI IDE controller, which uses IRQ 14 for Channel One and IRQ 15 for Channel Two. You can not share these IRQs between two controllers.

The next line is the "PCI Latency Timer" setting. Do not change the "80 PCI Clock" setting. This default setting enables maximum PCI performance for this mainboard.

Plug And Play

The seven "IRQ ... Used By ISA" lines indicate whether or not the IRQ indicated for each line is being used by a 'legacy' (non-PnP) ISA card. The default setting "No/ICU" indicates either that the IRQ is not in use by the ISA Bus or that an ISA Configuration Utility (ICU) is being used to determine if an ISA card is using that IRQ. If you install a legacy ISA card that needs a specific IRQ, and you are not using an ICU, you must set the line for that IRQ to "Yes".

For example, if you install a PnP ISA card that needs to use IRQ 3, you would set the "IRQ 3 Used By ISA" line to "No/ICU". If, however, you install a legacy ISA card that needs to use IRQ 3, and you are not using an ICU, set the "IRQ 3 Used By ISA" line to "Yes".

The three "DMA ... Used By ISA" lines indicate whether or not the DMA channel listed is being used by a legacy ISA card. The default setting "No/ICU" indicates either that the DMA channel is not in use by the ISA Bus or that an ICU is being used to determine if an ISA card is using that IRQ. If you install a legacy ISA card that needs to use a specific DMA channel, and you are not using an ICU, you must set the line for that channel to "Yes".

If you have a legacy ISA card that uses any memory segment in the C800h to DC00h address range and you have not used an ICU to specify the range it uses, you should set the base address and block size by using the "ISA MEM Block BASE" line. When you select a base address from the six options, the "ISA MEM Block SIZE" line will appear and you can select a block size from the four options. If you use an ICU to accomplish the same thing, leave "ISA MEM Block BASE" on the default "No/ICU" setting. If you have more than one legacy ISA card that needs to use this address range, you can increase the block size as necessary.

When you're finished making settings for this screen, press the <Esc> key to go back to the main screen.

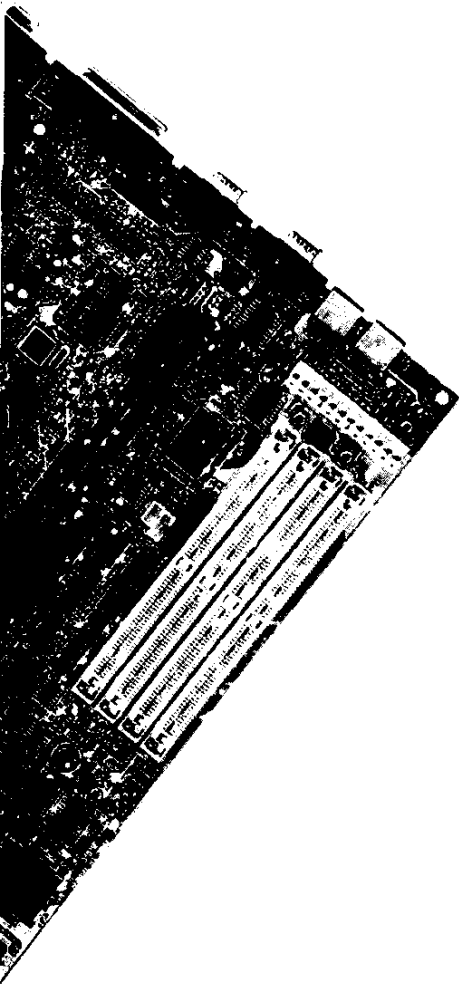

Load BIOS Defaults

“LOAD BIOS DEFAULTS” loads the troubleshooting default values permanently recorded in the BIOS ROM. These settings are non-optimal and turn off all high performance features.

The Standard CMOS Setup screen is not affected. To use this feature, highlight it on the main screen and press <Enter>. A line will appear asking if you want to load the BIOS default values. Press the <Y> key and then <Enter>. The default settings will load. Press <N> if you don't want to proceed.

Load BIOS Defaults Screen

```
ROM PCI/ISA BIOS (PI-5XTP4)
CMOS SETUP UTILITY
AWARD SOFTWARE, INC.

STANDARD CMOS SETUP
BIOS FEATURES SETUP
CHIPSET FEATURES SETUP
POWER MANAGEMENT SETUP
PCI AND PNP SETUP
LOAD BIOS DEFAULTS
LOAD SETUP DEFAULTS

SUPERVISOR PASSWORD
USER PASSWORD
IDE HDD AUTO DETECTION
SAVE & EXIT SETUP
SAVING

Load BIOS Defaults (Y/N)? N

ESC : Quit
F10 : Save & Exit Setup

↑↓←→ : Select Item
(SHIFT)F2 : Change Color

Load BIOS Defaults except Standard CMOS SETUP
```

Load Setup Defaults

The "LOAD SETUP DEFAULTS" option loads optimized settings from the BIOS ROM. Use this option to load default settings for normal use.

The Setup Defaults default settings do not affect the Standard CMOS Setup screen. To use the Setup Defaults, highlight the entry on the main screen and press <Enter>. A line will appear asking if you want to load the Setup default values. Press the <Y> key and then press <Enter>. The Setup Defaults will load. Press <N> if you don't want to proceed.

Load Setup Defaults Screen

ROM PCI/ISA BIOS (PI-5XTP4) CMOS SETUP UTILITY AWARD SOFTWARE, INC.	
STANDARD CMOS SETUP	SUPERVISOR PASSWORD
BIOS FEATURES SETUP	USER PASSWORD
CHIPSET FEATURES SETUP	IDE HDD AUTO DETECTION
POWER MANAGEMENT SETUP	SAVE & EXIT SETUP
PCI AND PNP SETUP	SAVING
LOAD BIOS DEFAULTS	Load SETUP Defaults (Y/N)? N
LOAD SETUP DEFAULTS	
ESC : Quit	↑↓← : Select Item
F10 : Save & Exit Setup	(SHIFT)F2 : Change Color
Load SETUP Defaults except Standard CMOS SETUP	

Setting Supervisor & User Passwords

The "SUPERVISOR PASSWORD" and "USER PASSWORD" options set passwords. The Supervisor Password is for system and Setup Utility access. The User Password is for the system only. The mainboard ships with no passwords. To create a password, highlight the type you want and press the <Enter> key. At the prompt, type your password. The password is case sensitive, and can be up to 8 alphanumeric characters. Press <Enter> after you have finished typing in the password. At the next prompt, confirm the new password by re-typing it and pressing <Enter> again. When you're done, the screen automatically reverts to the main screen. Remember, when you use this feature, the "Security Option" line in BIOS FEATURES SETUP will determine when entering the password will be required.

To disable either password, press the <Enter> key instead of entering a new password when the "Enter Password" dialog box appears. A message confirms the password has been disabled.

Password Setting

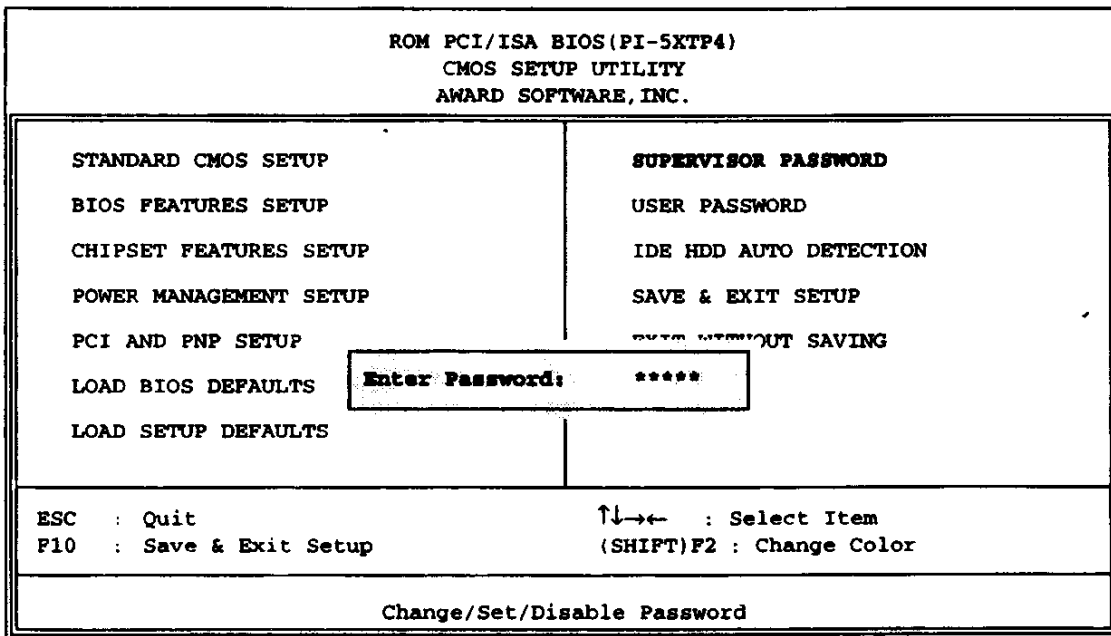

IDE HDD Auto Detection

If your system has an IDE hard drive, you can use this utility to detect its parameters and enter them into the Standard CMOS Setup automatically.

This utility will detect as many as four IDE drives if your system configuration supports that many. In sequence, a set of parameters for each drive will appear in the box. To accept the entries displayed press the Y key, to skip to the next drive, press the N key. If you accept the values, the parameters will appear listed beside the drive letter on the screen and the next letter, without parameters will appear and the program will attempt to detect parameters for the next drive. If you press the N key to skip rather than accept a set of parameters, zeros are entered after that drive letter.

Remember, if you use another IDE controller that does not have Enhanced IDE support for four devices, you can only install two IDE hard disk drives. Your IDE controller must support Enhanced IDE features in order to use Drive E: and Drive F:. The onboard PCI IDE controller supports Enhanced IDE and has two connectors that support a total of four IDE devices.

When you are finished, any entries you accepted are automatically entered on the line for that drive in the Standard CMOS Setup. Any entries you skipped are ignored and nothing is entered for that drive in Standard CMOS Setup.

Note: If you are setting up a hard disk that supports LBA mode, three lines will appear in the parameter box. Choose the line that lists LBA for an LBA drive. Do not choose Large or Normal.

IDE HDD Auto Detection Screen

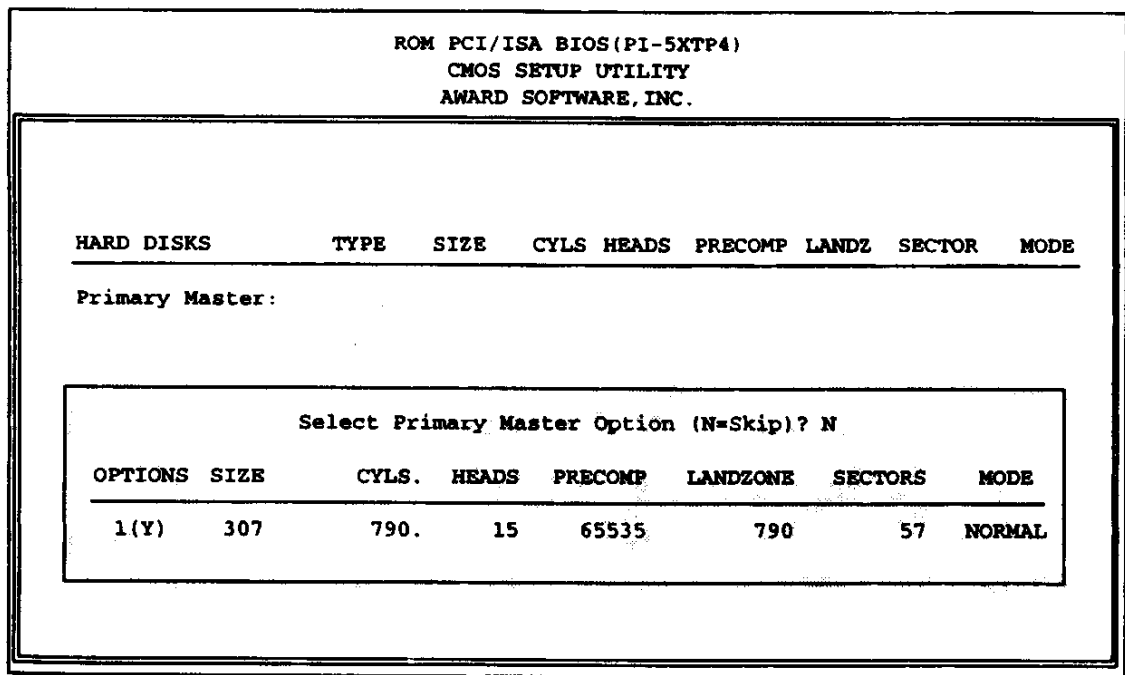

Important!: This utility will only detect one set of parameters for an IDE hard drive. Some IDE drives can use more than one set. This is not a problem if the drive is new and there is nothing on it. If the hard disk drive is already fully formatted when you install it, and different parameters than those detected here were used, you will have to enter them manually.

If the parameters listed don't match the ones used when the drive was formatted, the drive won't be readable. If the auto-detected parameters displayed do not match the ones that should be used for your drive, do not accept them. Press the <N> key to reject the values and enter the correct ones manually from the Standard CMOS Setup screen.

Save And Exit Setup

The next selection on the Utilities menu is "SAVE AND EXIT SETUP". If you select this and press the <Enter> key the values entered during the current session will be recorded in the CMOS memory on the mainboard. The system will check it every time you turn your system on and compare it to what it finds as it checks the system. This record is required for the system to operate.

Exit Without Saving

The last selection on the main screen is "EXIT WITHOUT SAVING". Selecting this option and pressing the <Enter> key lets you exit the Setup Utility without recording any new values or changing old ones. If you want to save a new configuration, do not use this option. If you use it, any new setting information will be lost.

You can now use your system without further reference to this utility unless you change the system hardware configuration. Remember, if the system configuration information stored in CMOS memory gets corrupted, you will have to reenter it.

NCR SCSI BIOS & Drivers

The NCR 53C810 SCSI BIOS is recorded on the same flash memory chip as the system BIOS. To use the onboard NCR SCSI BIOS, the optional SC-200 SCSI controller card must be installed in your system.

All SCSI devices you connect to your system require driver software. The NCR SCSI BIOS directly supports SCSI hard disks under DOS, Windows and OS/2. It also uses device drivers that are on the DOS-format support floppy disk that comes with the SC-200 controller card to support hard disks and other SCSI devices used with DOS, Windows, Windows NT, Novell NetWare and OS/2. These drivers provide higher performance than the direct BIOS support. To use these device drivers you must install them on your system hard disk drive and add them to your system configuration files. There is also driver support for SCSI devices used with SCO Unix. A second, SCO Unix-format, support floppy disk has the Unix drivers on it.

See the "Readme" files that come with the drivers for instructions on what they are and how to use them. You can print out the Readme files with any text editor.

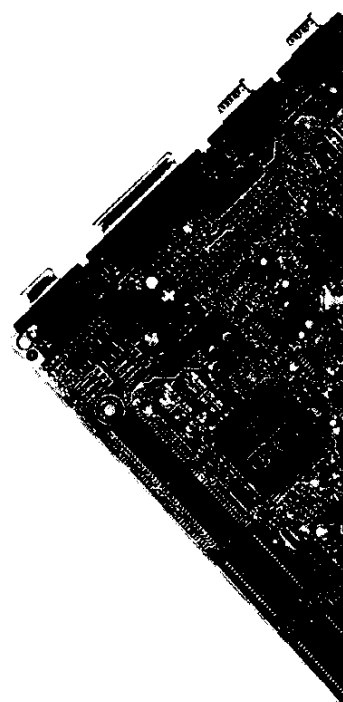

Flash Memory Writer Utility

Your mainboard comes with a utility to upgrade the BIOS. The BIOS is stored on a 'flash' EPROM BIOS ROM chip on the mainboard that can be erased and reprogrammed. This is what the Flash Memory Writer (FMW) utility does. The utility is in the "Flash" directory on the DOS-formatted support floppy disk that comes with the mainboard. You will find three files in the directory:

- PFLASH.EXE - the Flash Memory Writer utility
- README - a text file of instructions
- TR5Axxxx.AWD - a BIOS file for this mainboard

(xxxx = a 4-digit version number)

Flash Memory Writer records (or "programs") a new BIOS file onto the flash memory chip. The BIOS file on the support disk may be newer than the BIOS on the mainboard, so you may want to update your BIOS right away. Compare the four numbers after "TR5A" in the new BIOS file name to the last four numbers of the code that displays in the upper left-hand corner of your screen while the Power-On Self-Test is running. If the number from the support disk file is larger, then you should reprogram the System BIOS. If they are the same, don't bother. To reprogram the System BIOS, you must first do the following:

1. Set jumper JP9 to the enable programming. When you finish updating the BIOS, set JP9 back to the default Disable Programming/Normal Read setting. See Chapter 4 for jumper setting information.

2. Make sure the CPU is running in 'real mode'.

FMW will not run if the CPU is operating in protected or virtual mode. This means that you can not run it with Windows running or with any memory manager software (including HIMEM.SYS). You must disable any memory manager software first. The easiest way to do this is to:

- a. Boot your system from a bootable floppy disk with no config.sys or autoexec.bat files and then run Flash Memory Writer from a backup copy of your support disk. You can make your back-up floppy bootable when you format it, and use one disk for both purposes.
- b. If you are using MS-DOS 6.x, you can use the feature that allows you to confirm or abort each line of the config.sys file. You do this by pressing <F8> while the "Starting MS-DOS..." line is on the screen.

There are other ways to accomplish the same result. The main point is to make sure no memory managers are running. If you aren't sure, try running FMW. If it runs, you've succeeded. If it displays a warning message about the CPU mode, you'll have to try again.

Once you've satisfied the two requirements mentioned above, you can run FMW. You can copy the contents of the "Flash" directory to your hard disk drive, or you can run the utility from a backup of the support floppy disk. Make sure the new BIOS file is in the same directory as the FMW utility. To run FMW, switch to the "Flash" directory if you're not already in it. Type 'PFLASH' at the DOS prompt and press the <Enter> key. The following screen will appear:

The Flash Memory Writer Utility Screen

```
ASUSTek PNP BIOS
FLASH MEMORY WRITER V1.0
Copyright (C) 1995, ASUSTek COMPUTER Inc.

Flash Type -- SST 29EE010

Current BIOS Revision: #401A0-0109

Choose one of the following:

1. Save Current BIOS To File
2. Update BIOS Main Block From File
3. Advanced Features

Enter Choice: [1]

Press ESC To Exit
```

There are three command options which you invoke by typing the number of the command and pressing the "Enter" key:

1. Save Current BIOS To File

This command reads the system BIOS already installed on the mainboard and writes a copy of it to a file in the 'Flash' directory. This leaves you with a backup of your original BIOS in case you need to re-install it. This option is highly recommended.

2. Update BIOS Main Block From File

This updates the BIOS main block, but not the boot block or ESCD block, from a BIOS file on disk. This can be a new file or the backup file created by "Save Current BIOS To File".

3. Advanced Features

Selecting this option brings up the Advanced Features screen.

There is a line at the bottom of the screen "Press ESC To Exit".

If you press the Escape key the program will terminate and return you to the DOS prompt.

If you type a "3" and then press the "Enter" key the Advanced Features screen will appear.

The Advanced Features Screen

```
Advanced Features

Flash Type -- SST 29EE010

Current BIOS Revision: #401A0-0109

Choose one of the following:

1. Clear PNP ESCD Parameter Block

2. Update BIOS Including Boot Block and ESCD

Enter Choice: (2)

Press ESC To Exit
```

There are two command options which you invoke by typing the number of the command and pressing the "Enter" key:

1. Clear PnP ESCD Parameter Block
This command erases the Plug and Play configuration record.
2. Update BIOS Including Boot Block and ESCD.
This updates the Boot Block, the BIOS and the Plug and Play ESCD Parameter Block from a new file in the FLASH directory.

Operation and controls are the same as for the main screen.

Follow this procedure to update the Plug and Play system BIOS:

1. Back up your existing system BIOS by using the "Save Current BIOS To File" command. Type "1" and press "Enter" to execute the command. A second screen will appear.

Type the BIOS file name, e.g. TR5A0109.AWD, press "Enter" and the program will write a file containing the current BIOS to the directory you are running FMW from.

2. Install the new BIOS using the "Update BIOS Main Block From File" command. Type a "2" and press "Enter".

When you type this command a second screen will pop up instructing you to type in the name of the new BIOS file. Type in the whole file name, e.g. TR5A0110.AWD and press the "Enter" key to confirm that you want to program the BIOS. The utility will then install the new BIOS file.

DO NOT TURN OFF THE SYSTEM IF THERE IS A PROBLEM!

If you have a problem installing the new BIOS file, try again. If you are only updating the main block choose command "2" "Update BIOS Main Block From File" again and try again. If you are updating the main block, boot block and ESCD block, you must use the Advanced Features command "2", "Update BIOS Including Boot Block And ESCD". If you can not successfully program the new BIOS file for whatever reason, re-install your original BIOS from the backup file you created in Step 1 above.

Technical Summary

This section provides additional information on the technical specifications of the mainboard. The second part explains how to set up the optional PCI-SC200 SCSI Interface card.

Jumper Setting Summary

Base Address Selector: JP1 & JP2

These jumpers set the base address for the onboard audio.

	<i>JP1</i>	<i>JP2</i>	
220h	2&3	2&3	Default
240h	2&3	1&2	
260h	1&2	2&3	
280h	1&2	1&2	

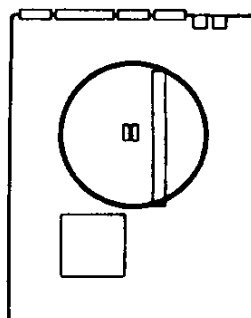
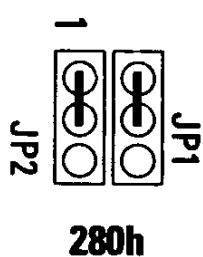
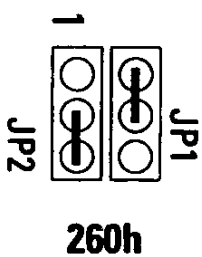
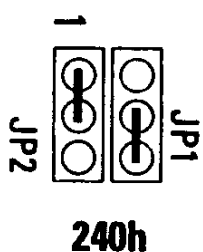
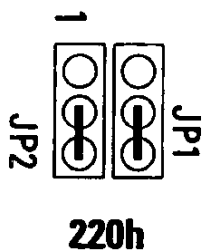

Bus & CPU External Clock Speed Selector: JP4, JP5 & JP6

Set these according to the Bus clock and the CPU's external clock speed.

Ext. Clock	JP4	JP5	JP6	Int. Clk Speed
66MHz	2&3	1&2	2&3	100/133/167MHz
60MHz	2&3	2&3	1&2	90/120/150MHz
50MHz	1&2	2&3	2&3	75MHz

Note: CPUs are normally listed by their *internal* clock speed. You **MUST** also set JP11 & 12 for the correct multiple of the external clock speed.

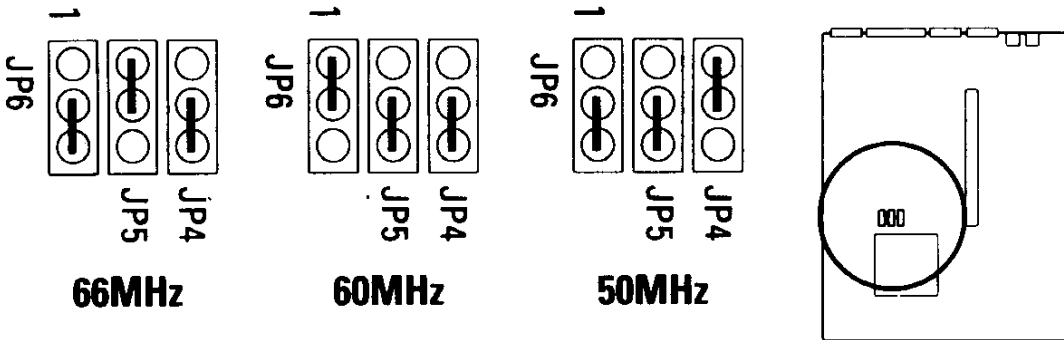

PS/2 Mouse Port Selector: JP7

This jumper controls the on-board PS/2 Mouse port. When set to Enable, the port is active and uses IRQ12.

	JP7	
Enable	1&2	Default
Disable	2&3	

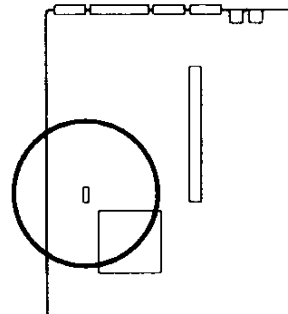
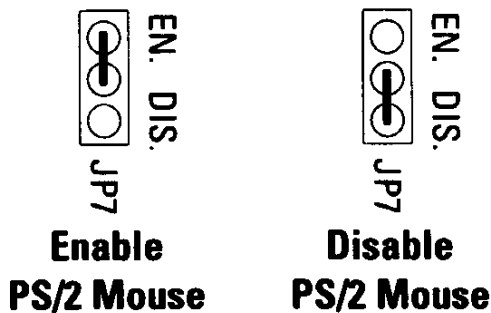

Flash EPROM Voltage Selector: JP8

This jumper is factory set for the type of EPROM chip installed.

<i>JP8</i>	
+5V	1&2
+12V	2&3

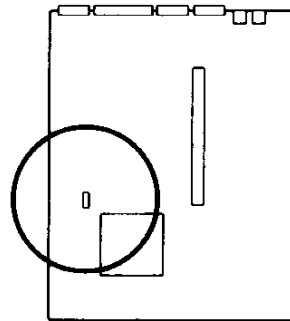
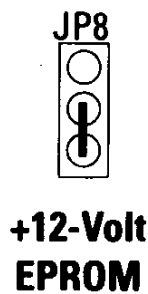

Flash EPROM Read/Write Selector: JP9

This jumper selects between Normal Read/Write Protected mode and Programming Enabled mode for the BIOS flash EPROM.

<i>JP9</i>		
Normal / W. Protect	1&2	Default
Programming Enabled	2&3	

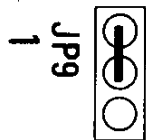

Normal Read Write Protect

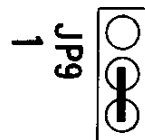

Enable Programming

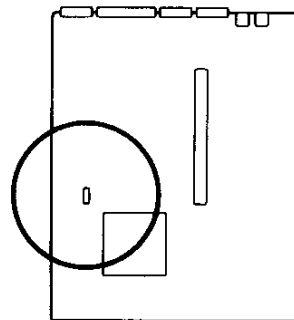

Level 2 Cache Size: JP10

This is factory- set based on the size of the cache mounted on the mainboard.

	JP10
256K	1&2
512K	2&3



256KB Cache

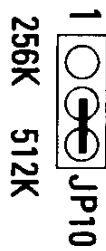

512KB Cache

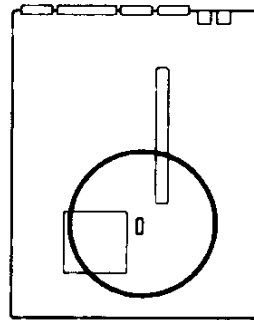

CPU Internal Clock External Multiple Selector: JP11 & JP12

The default setting is for 75MHz, 90MHz and 100MHz Pentium CPUs.

CPU Internal Clock	JP11	JP12	
Int. Clock = 1.5 x Ext. Clock	Open	Open	75/90/100
Int. Clock = 2 x Ext. Clock	Short	Open	120/133MHz
Int. Clock = 2.5 x Ext. Clock	Short	Short	150/167MHz
Int. Clock = 3 x Ext. Clock	Open	Short	

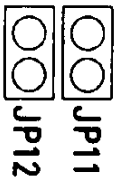

1.5 x Ext Clk

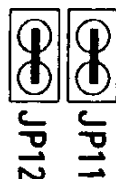

2.5 x Ext Clk

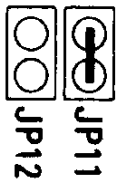

2 x Ext Clk

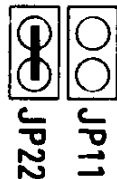

3 x Ext Clk

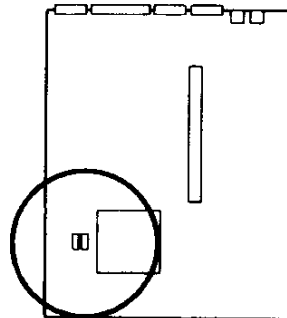

RTC Clear CMOS Memory: JP13

You can use this jumper to clear the CMOS memory that stores the BIOS Setup Utility configuration record, *including any passwords*. After clearing the CMOS memory you must run the BIOS Setup Utility again to create and store a new configuration record.

	JP13
Normal	Open
Clear	Short



Normal



**Clear CMOS
memory**

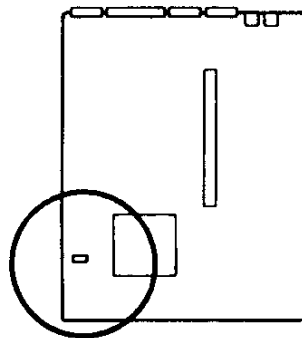

Voltage Regulator Type Selector: JP15

This jumper sets which type of voltage regulator is installed on the mainboard. It is set at the factory for the type of regulator installed at the time of manufacture. Do not change the setting. The information here is for reference only.

Regulator type	JP15
LP2951	Open
LT1084	Short



**LP2951
voltage regulator**



**LT1084
voltage regulator**

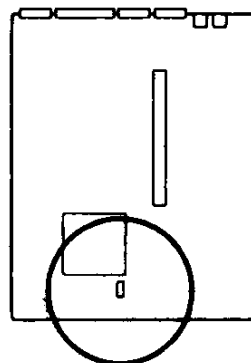

Voltage Regulator Output Selector: JP16, JP17

These set the CPU voltage and are factory-set for the installed CPU.

	<i>JP16</i>	<i>JP17</i>	
STD/VR	Short	Open	Default
VRE	Open	Short	

IMPORTANT: You must set these jumpers correctly for the CPU's voltage type or your system will operate improperly.

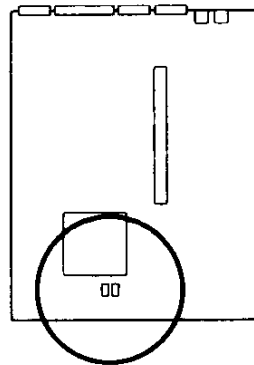
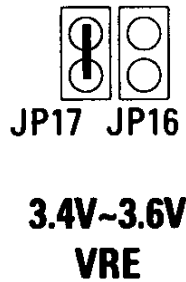
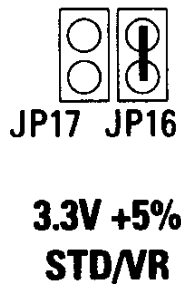

Voltage Regulator Module Selector: JP19, JP20, JP21, JP22

These jumpers set whether a VRM is installed in the Header 7 VRM socket.

	<i>JP19</i>	<i>JP20</i>	<i>JP21</i>	<i>JP22</i>
No VRM	Short	Short	Short	Short
VRM Installed	Open	Open	Open	Open

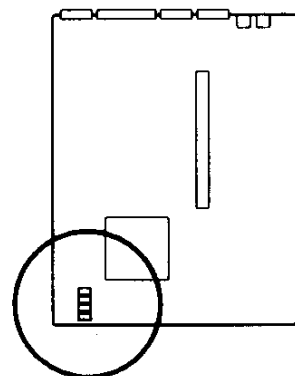
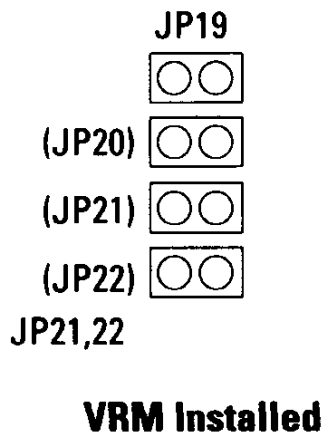
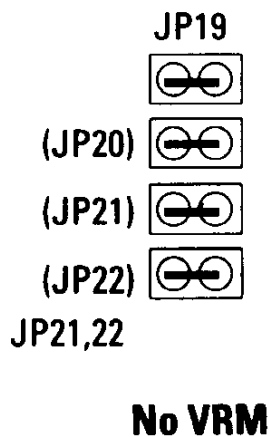

COM 2 Mode Selector: JP24 & JP25

These set COM2 to support either an RS-232 serial port or an Infrared (IR) port.

	JP24	JP25
RS-232	1&2	1&2
IR	2&3	2&3

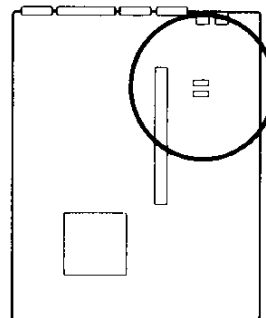
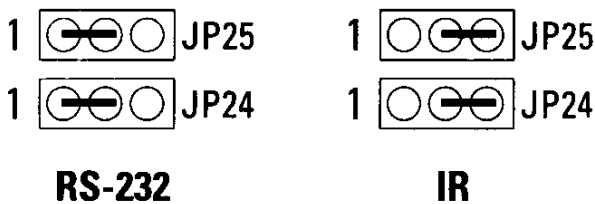

Memory Subsystem

Memory Specifications:

See pages 2-7.

Memory Configurations

See page 2-8 for a chart of the configuration options.

Level 2 Cache Options

SRAM type: Pipeline Burst

Cache Size: 256KB or 512KB factory-installed

Expansion Video DRAM Specifications:

Install two 256Kx16 DRAM chips in the expansion sockets to expand display memory to 2MB. The memory should have the following specifications:

Video DRAM Specifications: 256K x 16, 70ns, Dual CAS#

External Connections

There are several connectors on the board for switches and indicator lights from the system case. The connectors are made of the same components as the jumper switches. There are also connectors for the on-board I/O ports and the leads from a 5-volt system power supply.

Connector Block:

Power LED	Connector for a Power-On indicator LED lead
SMI Switch	Connector for a Suspend switch lead.
SMD Signal	Connector for a Suspend mode indicator.
Reset Switch	Connector for a Reset switch lead.
KeyLock	Connector for a keyboard lock.
Speaker	Connector for a system case speaker lead.

Other Connectors:

FANCN	Connector for the CPU cooling fan power lead (+12V).
JP14 IDE LED	Connector for an IDE activity LED lead.
IRCON	Connector for optional IrDA-compliant infrared port module

Sound Connectors:

SONY	Connector for SONY CD-ROM drive audio lead
PANASONIC	Connector for Panasonic CD-ROM drive audio lead
MTM	Connector for Mitsumi CD-ROM drive audio lead
WAVE TAB. CON.	Connector for Vibra 16S Wave Table Option
AUDIO CON.	Connector for Vibra 16S external port module

Connector Locations

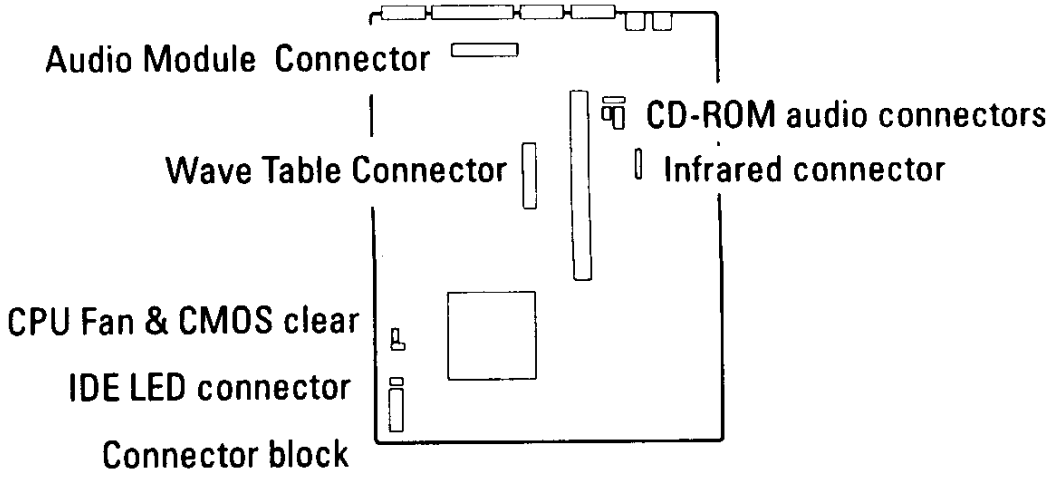

Connector Block

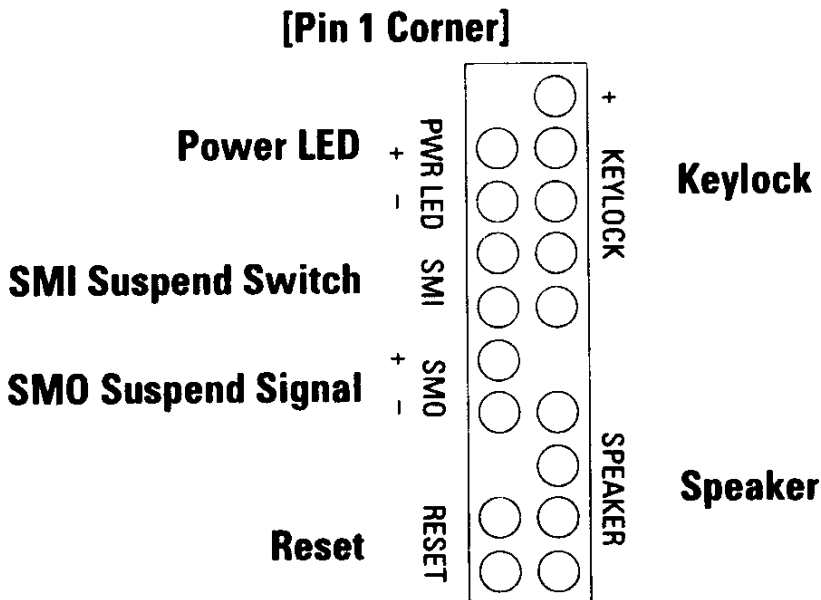

Other Feature Connectors

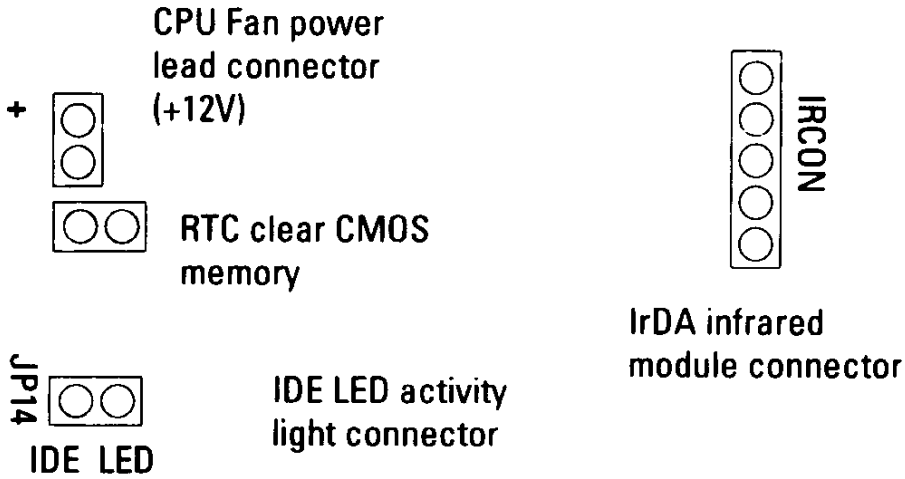

Audio Connectors

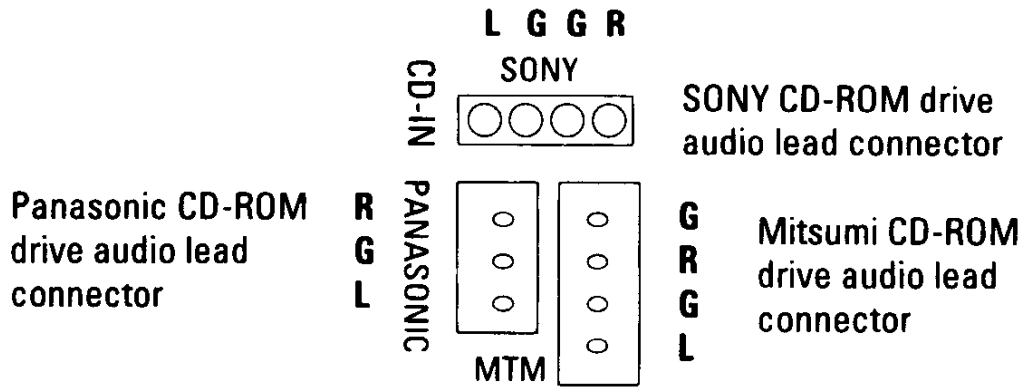

Pin Assignments

- G: Ground
- L: Left Channel
- R: Right Channel

External Audio Module

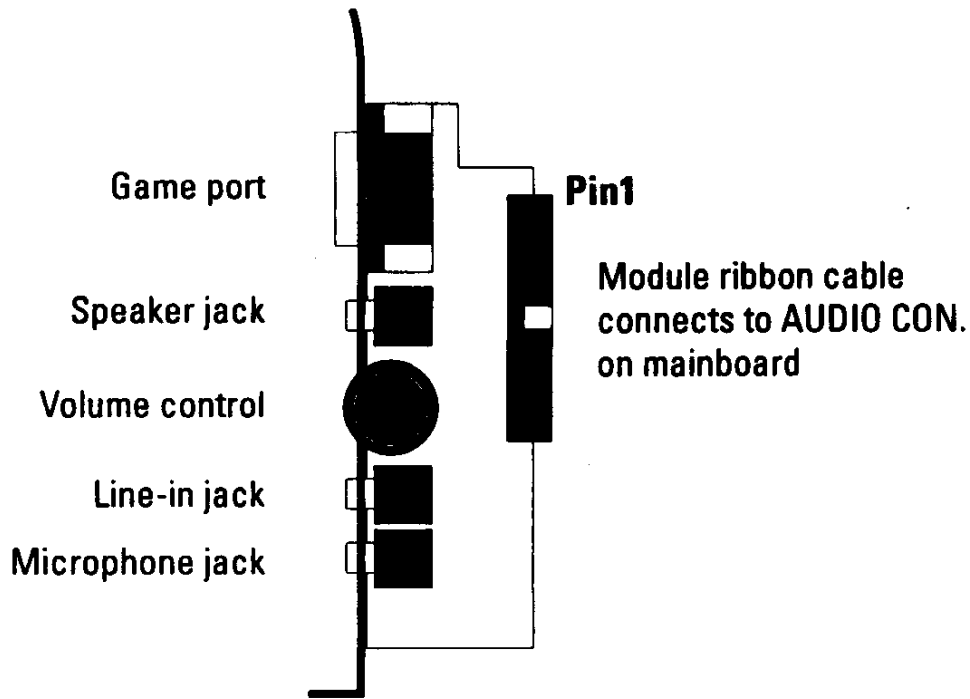

The external audio module installs in an empty horizontal expansion slot opening.

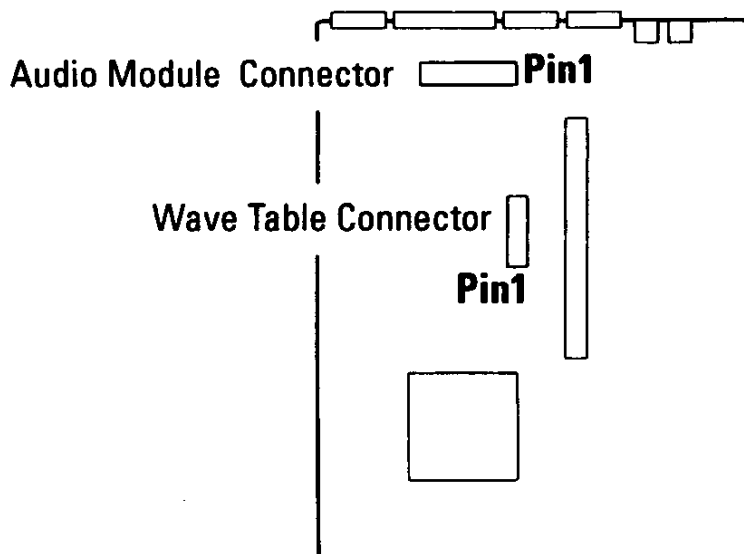

I/O Port Connectors

Pin1 is the upper left-hand pin on each connector

**Floppy Disk Drive
cable connector**

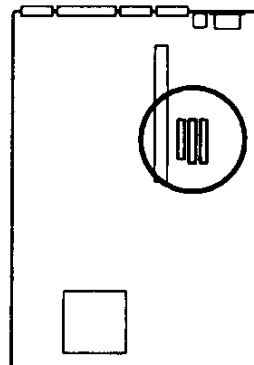

**IDE Hard Disk Drive
cable connectors,
Primary IDE (Middle)
Secondary IDE (Right)**

When you connect a ribbon cable to any of these I/O connectors, you must orient the cable connector so that the Pin 1 edge of the cable is at the Pin 1 end of the on-board connector. The Pin 1 edge of the ribbon cable is colored to identify it.

Controller Cables

The mainboard comes with the following cables:

- 1 IDE ribbon connector cables
- 1 floppy disk drive ribbon connector cable

Connector Cables

Floppy Drive ribbon cable



IDE ribbon cable

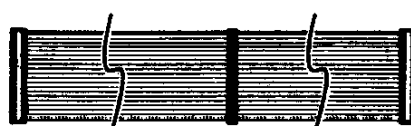

Connecting A Power Supply

The system power supply connector is for a 5-volt power supply. To connect the leads from the power supply, you should first make sure the power supply is unplugged. Most power supplies have two leads. Each lead has six wires, two of which are black. Orient the connectors so the black wires are in the middle.

Align the plastic guide pins on lead to their receptacles on the connector. You may need to hold the lead at an angle to line it up. Once you have the guide pins aligned, press the lead onto the connector so that the plastic clips on the lead snap into place and secure the lead to the connector.

See the diagram on page 1-7 for the location of these connectors.

Connecting Power Supply Leads

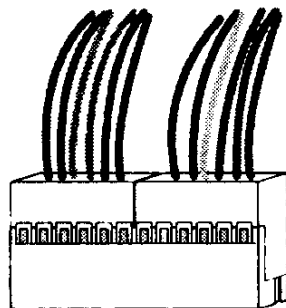

The black wires should be in the middle.

Onboard ATI mach64 Information

The onboard ATI mach64 video accelerator chip is capable of displaying a number of resolution and color depth combinations. The following chart lists the supported combinations and the video memory required.

Resolution	Display Memory	
	1MB	2MB
640x480x16	✓	✓
640x480x256	✓	✓
640x480x32K	✓	✓
640x480x64K	✓	✓
640x480x16.7M		✓
800x600x256	✓	✓
800x600x32K	✓	✓
800x600x64K	✓	✓
800x600x16.7M		✓
1024x768x256	✓	✓
1024x768x32K		✓
1024x768x64K		✓
1152x864x256	✓	✓
1280x1024x16	✓	✓
1280x1024x256		✓
1600x1200x256		✓

The PCI-SC200 SCSI Interface Card

Your mainboard may have come with an optional SCSI (Small Computer System Interface) controller card, the PCI-SC200. The card is also available separately. This card works with the SCSI BIOS on the mainboard. Together, they provide a complete PCI Fast SCSI-2 interface. With the card installed in your system you can connect SCSI devices installed in your system case to the internal connector on the card. You also have the additional option of connecting external SCSI devices to the external SCSI-2 connector on the card.

If you get the PCI-SC200 later on as an option, you will need to install it yourself. The setup procedure is explained here. The basic card installation procedure is explained in Chapter 2.

The PCI-SC200 SCSI Interface Card

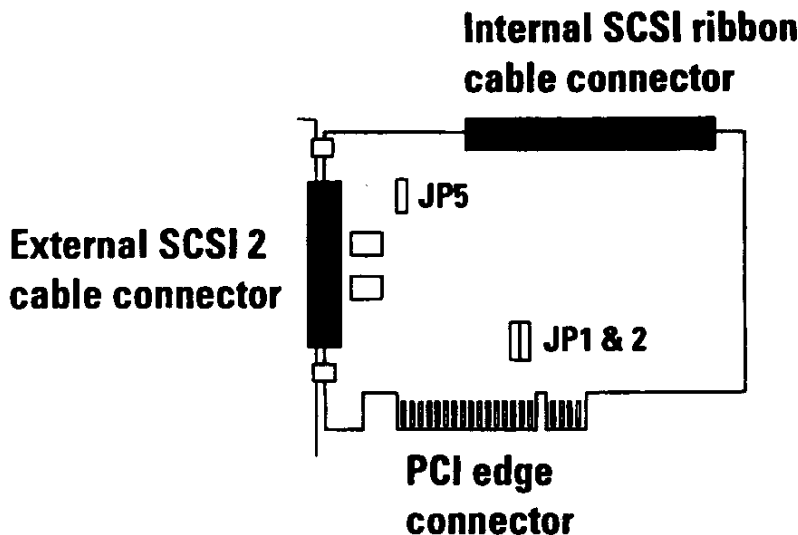

Setting Up the PCI-SC200

There are two jumper settings you may need to make on the card to set it up. One setting assigns the PCI INT interrupt, the other sets the card's termination.

Setting the INT Assignment

As explained in Chapter 2, any PCI card you install must use PCI INT A. On the PCI-SC200, you assign the INT by setting jumper JP1 or JP2. The default setting for the card already is INT A, so you do not need to change the setting to use the SC-200 with this mainboard.

The INT assignment jumper settings are illustrated below. The settings are printed on the card for your convenience.

JP1 & 2: Interrupt settings

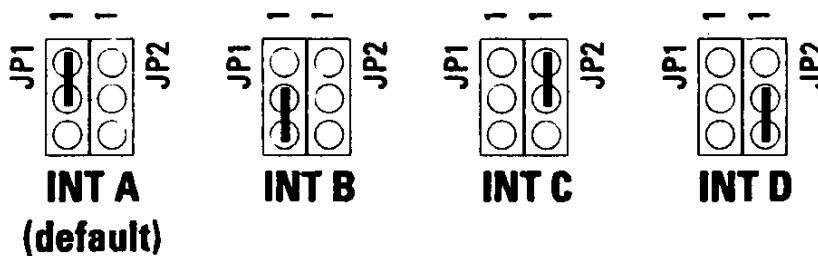

Terminator Settings

SCSI devices are connected together in a "chain" by cables. Internal devices connect to the PCI-SC200 with a fifty-pin flat ribbon cable. External devices connect to the external port with a SCSI-2 cable. If there is more than one internal or external device, additional devices are connected with cables to form a "daisy chain". The SCSI chain must be "terminated" at both ends, or the devices in the chain will not work properly.

Many SCSI devices use a set of terminating resistors to terminate the device. The PCI-SC200 has "active" termination that you set using jumper JP5. If you need to terminate the PCI-SC200, you do it by setting the jumper. There are two settings, terminated and unterminated, as shown below.

JP5: Terminator setting

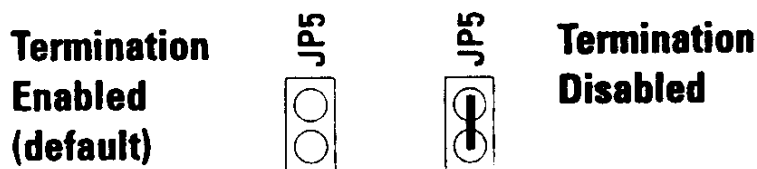

Decide whether or not you need to terminate the PCI-SC200 based on its position in the SCSI chain. Only the devices at each end of the chain need to be terminated. If you have *only* internal or *only* external devices connected to the PCI-SC200, then you *must* terminate the PCI-SC200. If you have *both* internal and external devices connected, you *must not* terminate the card. The figures on the next page illustrate these requirements.

Example 1: Only internal or only external devices connected

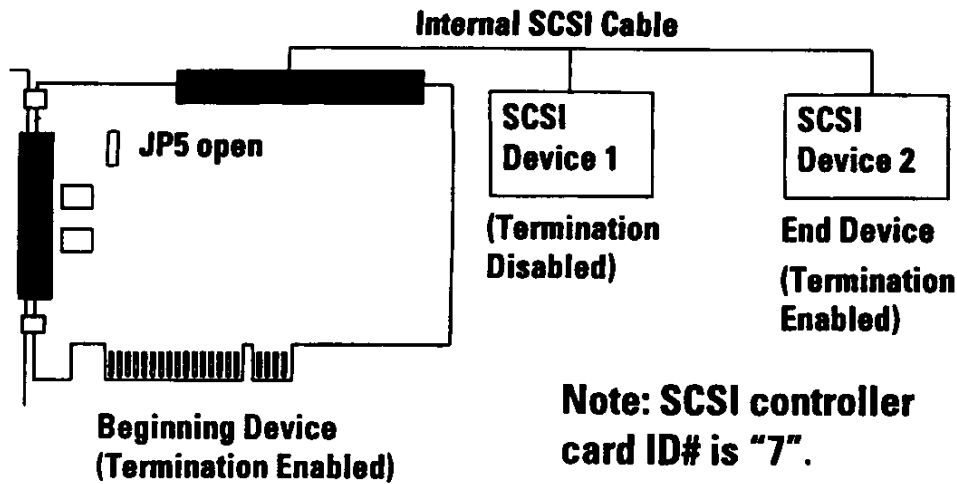

Example 2: Both internal and external devices connected

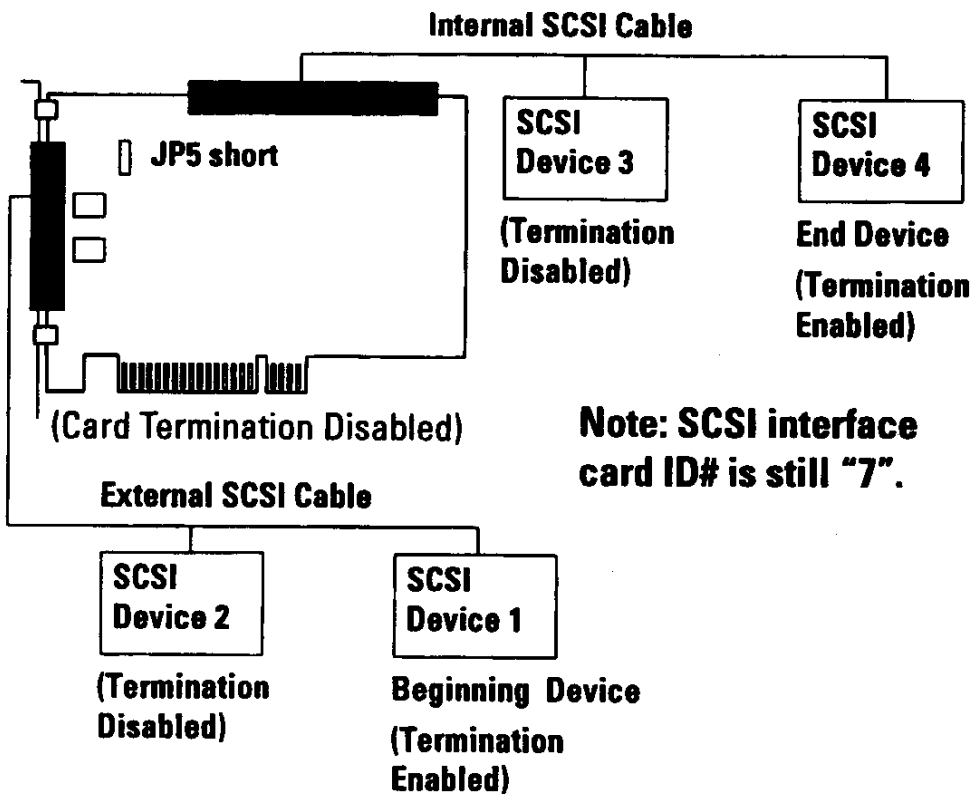

SCSI ID Numbers

All SCSI devices, including the PCI-SC200 interface card must have a SCSI identification number that is not in use by any other SCSI device. There are eight possible ID numbers, 0 through 7. The PCI-SC200 has a fixed SCSI ID of 7.

You can connect up to seven SCSI devices to the interface card. You must set a SCSI ID number for each device. SCSI devices vary in how they set the ID number. Some use jumpers, others have some kind of selector switch. Refer to the manual for any device you install for details on how to set its ID number.

